



THE DATASHEET OF LMB16S-TP



Features

- Halogen Free. "Green" Device (Note 1)
- High Current Capability
- Low Profile Package
- Epoxy Meets UL 94 V-0 Flammability Rating
- Moisture Sensitivity Level 1
- Lead Free Finish/RoHS Compliant (Note 2) ("P" Suffix Designates RoHS Compliant. See Ordering Information)

Maximum Ratings @ 25°C (Unless Otherwise Specified)

Parameter	Symbol	Value					Unit
		LMB12S	LMB14S	LMB16S	LMB18S	LMB110S	
Peak Repetitive Reverse Voltage	V_{RRM}	20	40	60	80	100	V
Working Peak Reverse Voltage	V_{RWM}						
DC Blocking Voltage	V_R						
RMS Reverse Voltage	V_{RMS}	14	28	42	56	70	V
Average Rectified Forward Current	$I_{F(AV)}$	1					A
Non-Repetitive Peak Surge Current @ 8.3ms Half Sine Wave	I_{FSM}	30					A
Current Squared Time @ $1ms \leq t \leq 8.3ms$	I^2t	3.735					A ² s

Marking code

Part Number	Marking Code
LMB12S	LB12S
LMB14S	LB14S
LMB16S	LB16S
LMB18S	LB18S
LMB110S	LB110S

Internal Structure

Pin	Description	Simplified Outline	Graphic Symbol
1	Anode		
4	Cathode		
2&3	AC		

- Note: 1. Halogen free "Green" products are defined as those which contain <900ppm bromine, <900ppm chlorine (<1500ppm total Br + Cl) and <1000ppm antimony compounds.
2. High temperature solder exemption applied, see EU directive annex 7a.

1 Amp
General Purpose AC Bridge
20 to 100 Volts

LMBS-1

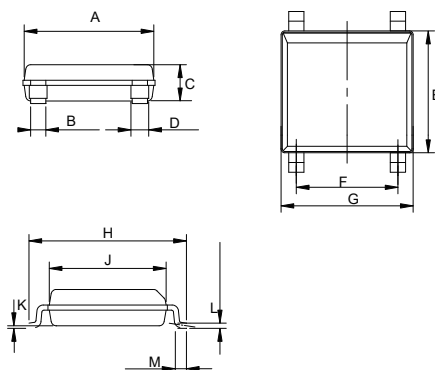

DIM	INCHES		MM		NOTE
	MIN	MAX	MIN	MAX	
A	0.197	0.205	4.90	5.20	
B	0.024		0.60		
C	---	0.059	---	1.50	
D	0.024	0.032	0.60	0.80	
E	---	0.189	---	4.80	
F	0.150	0.165	3.80	4.20	
G	---	0.209	---	5.30	
H	0.236	0.252	6.00	6.60	
J	0.177	0.185	4.30	4.70	
K	0.0009	0.004	0.02	0.21	
L	0.006	0.012	0.15	0.30	
M	0.017	0.031	0.25	0.80	

Suggested Solder Pad Layout

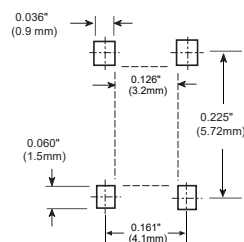

Thermal characteristics

Symbol	Parameter	Conditions	Min	Typ	Max	Unit
T_J	Operating Junction Temperature Range		-55		150	°C
T_{stg}	Storage Temperature Range		-55		150	°C
$R_{th(J-L)}$	Thermal Resistance from Junction to Lead			25		°C/W
$R_{th(J-A)}$	Thermal Resistance from Junction to Ambient			62.5		°C/W

Electrical Characteristics @ 25°C Unless Otherwise Specified

Parameter	Symbol	Test Conditions	Min	Typ	Max	Unit
Forward Voltage LMB12S~LMB14S LMB16S LMB18S~LMB110S	V_F	$I_F=0.5A; T_J=25^\circ C$			0.55 0.65 0.85	V
Reverse Current LMB12S~LMB16S LMB18S~LMB110S	I_R	at Rated $V_R; T_J=25^\circ C$ at Rated $V_R; T_J=125^\circ C$ at Rated $V_R; T_J=25^\circ C$ at Rated $V_R; T_J=125^\circ C$			0.1 20 0.01 5	mA
Junction Capacitance LMB12S~LMB14S LMB16S LMB18S~LMB110S	C_J	$V_R=4V; f=1MHz; T_J=25^\circ C$		50 40 30		pF

Curve Characteristics

Fig. 1 - Forward Current Derating Curve

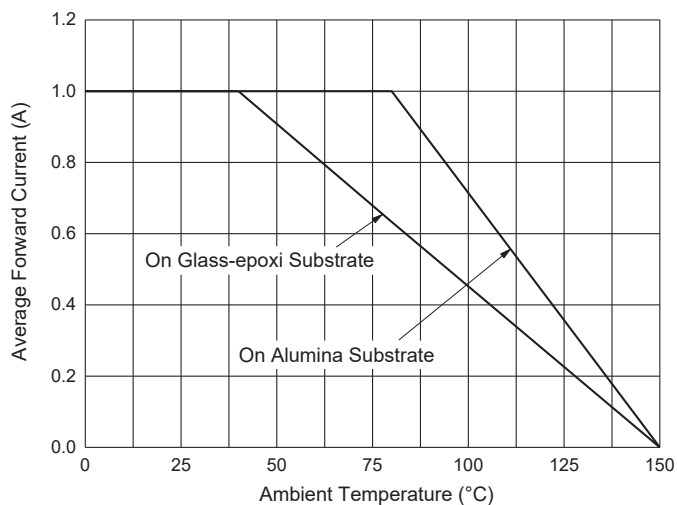

Fig. 2 - Maximum Non-Repetitive Peak Forward Surge Current

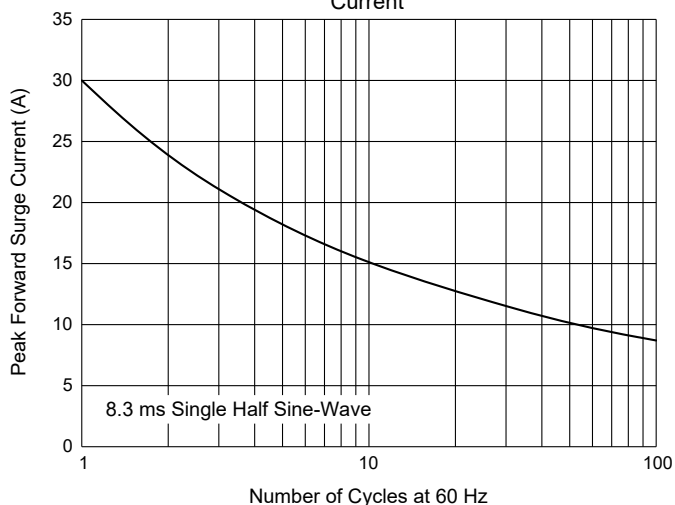

Fig. 3 - Typical Forward Characteristics

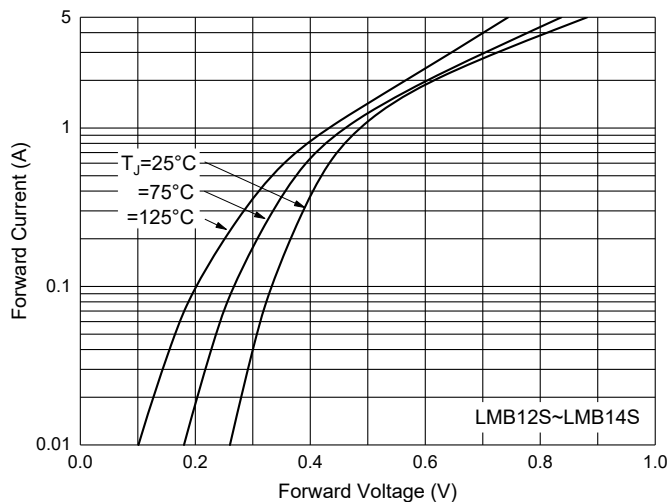

Fig. 4 - Typical Reverse Leakage Characteristics

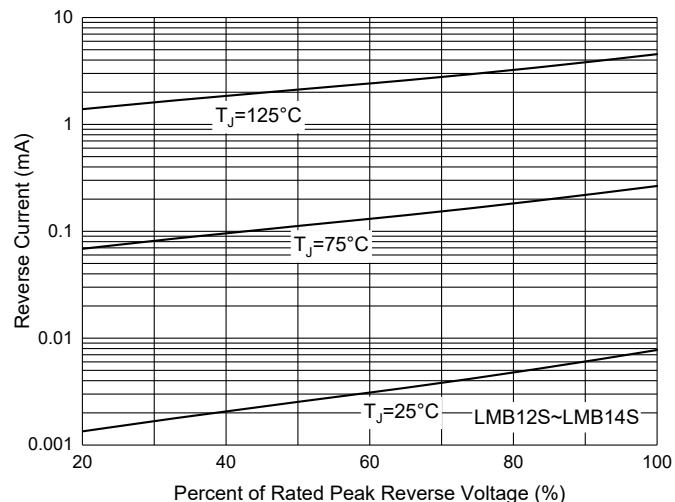

Fig. 5 - Typical Forward Characteristics

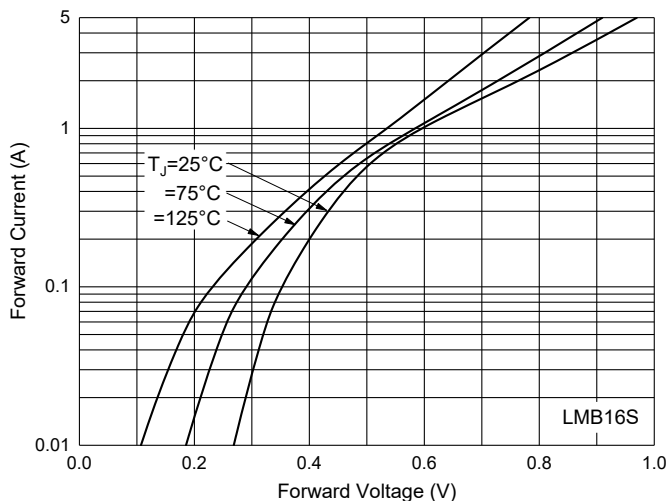
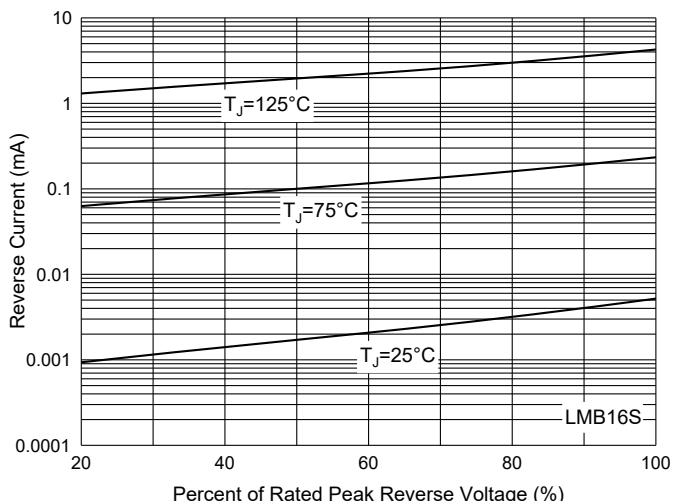

Fig. 6 - Typical Reverse Leakage Characteristics



Curve Characteristics

Fig. 7 - Typical Forward Characteristics

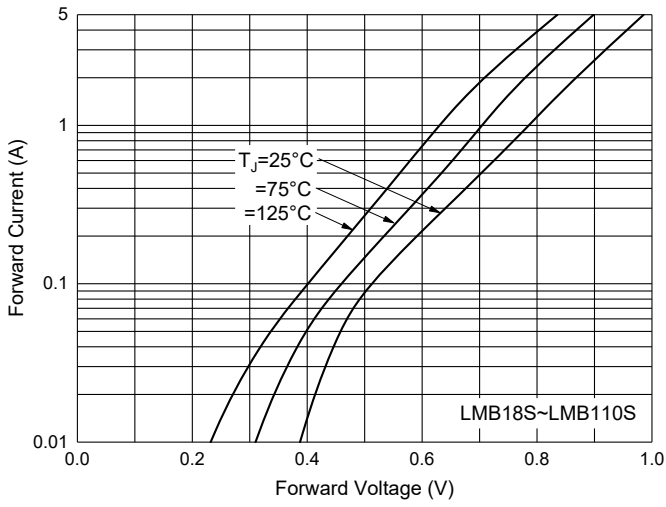

Fig. 8 - Typical Reverse Leakage Characteristics

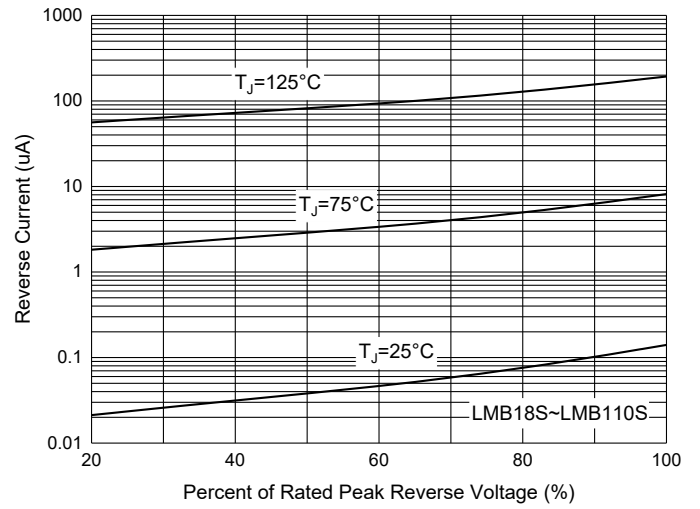
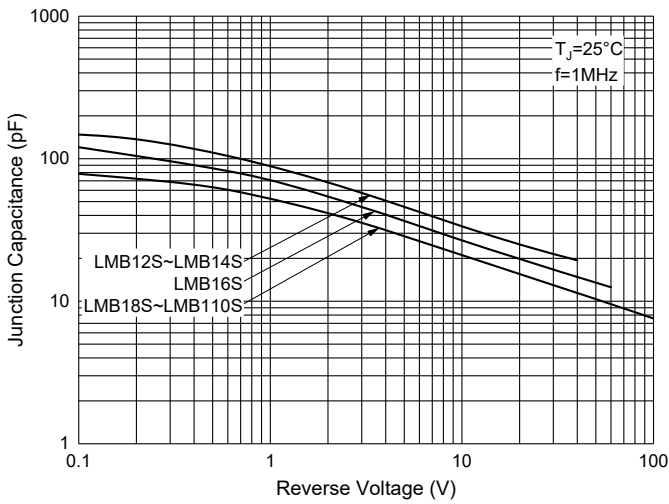

Fig. 9 - Typical Capacitance Characteristics



Ordering Information

Device	Packing
Part Number-TP	Tape&Reel:5Kpcs/Reel

IMPORTANT NOTICE

Micro Commercial Components Corp. reserves the right to make changes without further notice to any product herein to make corrections, modifications, enhancements, improvements, or other changes. **Micro Commercial Components Corp.** does not assume any liability arising out of the application or use of any product described herein; neither does it convey any license under its patent rights, nor the rights of others. The user of products in such applications shall assume all risks of such use and will agree to hold **Micro Commercial Components Corp.** and all the companies whose products are represented on our website, harmless against all damages. **Micro Commercial Components Corp.** products are sold subject to the general terms and conditions of commercial sale, as published at <https://www.mccsemi.com/Home/TermsAndConditions>.

LIFE SUPPORT

MCC's products are not authorized for use as critical components in life support devices or systems without the express written approval of Micro Commercial Components Corporation.

CUSTOMER AWARENESS

Counterfeiting of semiconductor parts is a growing problem in the industry. Micro Commercial Components (MCC) is taking strong measures to protect ourselves and our customers from the proliferation of counterfeit parts. MCC strongly encourages customers to purchase MCC parts either directly from MCC or from Authorized MCC Distributors who are listed by country on our web page cited below. Products customers buy either from MCC directly or from Authorized MCC Distributors are genuine parts, have full traceability, meet MCC's quality standards for handling and storage. **MCC will not provide any warranty coverage or other assistance for parts bought from Unauthorized Sources.** MCC is committed to combat this global problem and encourage our customers to do their part in stopping this practice by buying direct or from authorized distributors.

Looking for pricing, stock, or lifecycle information?

Click below to explore more details on WIN SOURCE:

- [View LMB16S-TP on WIN SOURCE](#)
- [Micro Commercial Co Information](#)

Optimize Your Supply Chain with WIN SOURCE Solutions

- ✓ Global Sourcing Solution
- ✓ Obsolete Management
- ✓ Cost Control Management
- ✓ Shortage Management
- ✓ Alternative Solution
- ✓ Excess Inventory Management