



**THE DATASHEET OF
ISL28246FBZ-T7**



5MHz, Single and Dual Rail-to-Rail Input-Output (RRIO) Op Amps

www.datasheet4u.com

The ISL28146 and ISL28246 are low-power single and dual operational amplifiers optimized for single supply operation from 2.4V to 5.5V, allowing operation from one lithium cell or two Ni-Cd batteries. They feature a gain-bandwidth product of 5MHz and are unity-gain stable with a -3dB bandwidth of 13MHz.

These devices feature an Input Range Enhancement Circuit (IREC) which enables them to maintain CMRR performance for input voltages greater than the positive supply. The input signal is capable of swinging 0.25V above a 5.0V supply and to within 10mV from ground. The output operation is rail-to-rail.

The parts draw minimal supply current while meeting excellent DC accuracy, AC performance, noise and output drive specifications. The ISL28146 features an enable pin that can be used to turn the device off and reduce the supply current to only 16µA. Operation is guaranteed over -40°C to +125°C temperature range.

Ordering Information

PART NUMBER (Note)	PART MARKING	PACKAGE (Pb-free)	PKG. DWG. #
ISL28146FHZ-T7*	GABS	6 Ld SOT-23	MDP0038
ISL28146FHZ-T7A*	GABS	6 Ld SOT-23	MDP0038
Coming Soon ISL28246FBZ	28246 FBZ	8 Ld SOIC	MDP0027
Coming Soon ISL28246FBZ-T7*	28246 FBZ	8 Ld SOIC	MDP0027
Coming Soon ISL28246FUZ	8246Z	8 Ld MSOP	MDP0043
Coming Soon ISL28246FUZ-T7*	8246Z	8 Ld MSOP	MDP0043

*Please refer to TB347 for details on reel specifications

NOTE: These Intersil Pb-free plastic packaged products employ special Pb-free material sets; molding compounds/die attach materials and 100% matte tin plate PLUS ANNEAL - e3 termination finish, which is RoHS compliant and compatible with both SnPb and Pb-free soldering operations. Intersil Pb-free products are MSL classified at Pb-free peak reflow temperatures that meet or exceed the Pb-free requirements of IPC/JEDEC J STD-020.

Features

- 5MHz gain bandwidth product @ $A_V = 100$
- 13MHz -3db unity gain bandwidth
- 950µA typical supply current (per amplifier)
- 650µV maximum offset voltage (6 Ld SOT-23)
- 16nA typical input bias current
- Down to 2.4V single supply voltage range
- Rail-to-rail input and output
- Enable pin (ISL28146 only)
- -40°C to +125°C operation
- Pb-free (RoHS compliant)

Applications

- Low-end audio
- 4mA to 20mA current loops
- Medical devices
- Sensor amplifiers
- ADC buffers
- DAC output amplifiers

Pinouts

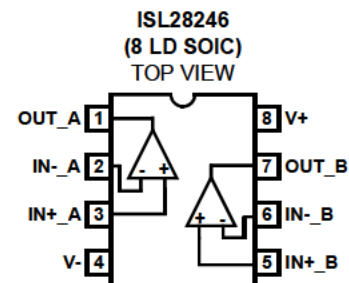
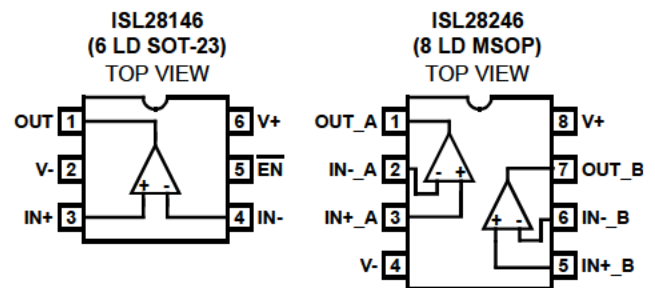

Absolute Maximum Ratings ($T_A = +25^\circ\text{C}$)

Supply Voltage	5.75V
Supply Turn On Voltage Slew Rate	1V/ μs
Differential Input Current	5mA
Differential Input Voltage	0.5V
Input Voltage	V ₋ - 0.5V to V ₊ + 0.5V
ESD Rating	
Human Body Model	3kV
Machine Model	300V

Thermal Information

Thermal Resistance	θ_{JA} ($^\circ\text{C}/\text{W}$)
6 Ld SOT-23 Package	230
8 Ld SOIC Package	110
8 Ld MSOP Package	115
Output Short-Circuit Duration	Indefinite
Ambient Operating Temperature Range	-40 $^\circ\text{C}$ to +125 $^\circ\text{C}$
Storage Temperature Range	-65 $^\circ\text{C}$ to +150 $^\circ\text{C}$
Operating Junction Temperature	+125 $^\circ\text{C}$
Pb-free reflow profile	see link below
	http://www.intersil.com/pbfree/Pb-FreeReflow.asp

CAUTION: Do not operate at or near the maximum ratings listed for extended periods of time. Exposure to such conditions may adversely impact product reliability and result in failures not covered by warranty.

IMPORTANT NOTE: All parameters having Min/Max specifications are guaranteed. Typical values are for information purposes only. Unless otherwise noted, all tests are at the specified temperature and are pulsed tests, therefore: $T_J = T_C = T_A$

Electrical Specifications $V_+ = 5\text{V}$, $V_- = 0\text{V}$, $V_{CM} = 2.5\text{V}$, $R_L = \text{Open}$, $T_A = +25^\circ\text{C}$ unless otherwise specified.
Boldface limits apply over the operating temperature range, -40 $^\circ\text{C}$ to +125 $^\circ\text{C}$.
 Temperature data established by characterization.

PARAMETER	DESCRIPTION	CONDITIONS	MIN (Note 1)	TYP	MAX (Note 1)	UNIT
DC SPECIFICATIONS						
V_{OS}	Input Offset Voltage	6 Ld SOT-23	-600 -650	-120	400 450	μV
$\frac{\Delta V_{OS}}{\Delta T}$	Input Offset Voltage vs Temperature			0.3		$\mu\text{V}/^\circ\text{C}$
I_{OS}	Input Offset Current		-10 -15	0	10 15	nA
I_B	Input Bias Current		-10 -15	16	35 40	nA
CMIR	Common-Mode Voltage Range	Guaranteed by CMRR	0		5	V
CMRR	Common-Mode Rejection Ratio	$V_{CM} = 0\text{V}$ to 5V	90 85	114		dB
PSRR	Power Supply Rejection Ratio	$V_+ = 2.4\text{V}$ to 5.5V	90 85	99		dB
A_{VOL}	Large Signal Voltage Gain	$V_O = 0.5\text{V}$ to 4V, $R_L = 100\text{k}\Omega$ to V_{CM}	600 500	1770		V/mV
		$V_O = 0.5\text{V}$ to 4V, $R_L = 1\text{k}\Omega$ to V_{CM}		140		V/mV
V_{OUT}	Maximum Output Voltage Swing	Output low, $R_L = 100\text{k}\Omega$ to V_{CM}		3	6 10	mV
		Output low, $R_L = 1\text{k}\Omega$ to V_{CM}		70	90 110	mV
		Output high, $R_L = 100\text{k}\Omega$ to V_{CM}	4.99 4.98	4.994		mV
		Output high, $R_L = 1\text{k}\Omega$ to V_{CM}	4.92 4.89	4.94		V
$I_{S,ON}$	Supply Current, Enabled		0.8 0.5	0.95	1.1 1.4	mA
$I_{S,OFF}$	Supply Current, Disabled			10	14 16	μA
I_{O+}	Short-Circuit Output Source Current	$R_L = 10\Omega$ to V_{CM}	48 45	56		mA

ISL28146, ISL28246

Electrical Specifications $V_+ = 5V$, $V_- = 0V$, $V_{CM} = 2.5V$, $R_L = \text{Open}$, $T_A = +25^\circ\text{C}$ unless otherwise specified.
Boldface limits apply over the operating temperature range, -40°C to $+125^\circ\text{C}$.
 Temperature data established by characterization. (Continued)

PARAMETER	DESCRIPTION	CONDITIONS	MIN (Note 1)	TYP	MAX (Note 1)	UNIT
I_{O-}	Short-Circuit Output Sink Current	$R_L = 10\Omega$ to V_{CM}	50 45	54		mA
V_{SUPPLY}	Supply Operating Range	V_+ to V_-	2.4		5.5	V
V_{ENH}	\overline{EN} Pin High Level		2			V
V_{ENL}	\overline{EN} Pin Low Level				0.8	V
I_{ENH}	\overline{EN} Pin Input High Current	$V_{\overline{EN}} = V_+$		1	1.5 1.6	μA
I_{ENL}	\overline{EN} Pin Input Low Current	$V_{\overline{EN}} = V_-$		16	25 30	nA
AC SPECIFICATIONS						
GBW	Gain Bandwidth Product	$A_V = 100$, $R_F = 100\text{k}\Omega$, $R_G = 1\text{k}\Omega$		5		MHz
Unity Gain Bandwidth	-3dB Bandwidth	$A_V = 1$, $R_F = 0\Omega$, $R_L = 10\text{k}\Omega$, $V_{OUT} = 10\text{mV}_{P-P}$		13		MHz
e_N	Input Noise Voltage Peak-to-Peak	$f = 0.1\text{Hz}$ to 10Hz		0.4		μV_{P-P}
	Input Noise Voltage Density	$f_O = 1\text{kHz}$		12		$\text{nV}/\sqrt{\text{Hz}}$
i_N	Input Noise Current Density	$f_O = 10\text{kHz}$		0.35		$\text{pA}/\sqrt{\text{Hz}}$
CMRR	Input Common Mode Rejection Ratio	$f_O = \text{to } 120\text{Hz}$, $V_{CM} = 1V_{P-P}$, $R_L = 1\text{k}\Omega$		-90		dB
PSRR- to 120Hz	Power Supply Rejection Ratio (V_-)	V_+ , $V_- = \pm 1.2V$ and $\pm 2.5V$, $V_{SOURCE} = 1V_{P-P}$, $R_L = 1\text{k}\Omega$		-88		dB
PSRR+ to 120Hz	Power Supply Rejection Ratio (V_+)	V_+ , $V_- = \pm 1.2V$ and $\pm 2.5V$, $V_{SOURCE} = 1V_{P-P}$, $R_L = 1\text{k}\Omega$		-105		dB
TRANSIENT RESPONSE						
SR	Slew Rate	$V_{OUT} = \pm 1.5V$, $R_f = 50\text{k}\Omega$, $R_G = 50\text{k}\Omega$ to V_{CM}		± 1.9		$\text{V}/\mu\text{s}$
t_r , t_f , Large Signal	Rise Time, 10% to 90%, V_{OUT}	$A_V = +2$, $V_{OUT} = 2V_{P-P}$, $R_g = R_f = R_L = 1\text{k}\Omega$ to V_{CM}		0.6		μs
	Fall Time, 90% to 10%, V_{OUT}	$A_V = +2$, $V_{OUT} = 2V_{P-P}$, $R_g = R_f = R_L = 1\text{k}\Omega$ to V_{CM}		0.5		μs
t_r , t_f , Small Signal	Rise Time, 10% to 90%, V_{OUT}	$A_V = +2$, $V_{OUT} = 10\text{mV}_{P-P}$, $R_g = R_f = R_L = 1\text{k}\Omega$ to V_{CM}		65		nS
	Fall Time, 90% to 10%, V_{OUT}	$A_V = +2$, $V_{OUT} = 10\text{mV}_{P-P}$, $R_g = R_f = R_L = 1\text{k}\Omega$ to V_{CM}		62		nS
$t_{\overline{EN}}$	Enable to Output Turn-on Delay Time, 10% \overline{EN} to 10% V_{OUT}	$V_{\overline{EN}} = 5V$ to $0V$, $A_V = +2$, $R_g = R_f = R_L = 1\text{k}\Omega$ to V_{CM}		5		μs
	Enable to Output Turn-off Delay Time, 10% \overline{EN} to 10% V_{OUT}	$V_{\overline{EN}} = 0V$ to $5V$, $A_V = +2$, $R_g = R_f = R_L = 1\text{k}\Omega$ to V_{CM}		0.3		μs

NOTE:

- Parts are 100% tested at $+25^\circ\text{C}$. Temperature limits established by characterization and are not production tested.

Typical Performance Curves $V_+ = 5V$, $V_- = 0V$, $V_{CM} = 2.5V$, $R_L = \text{Open}$

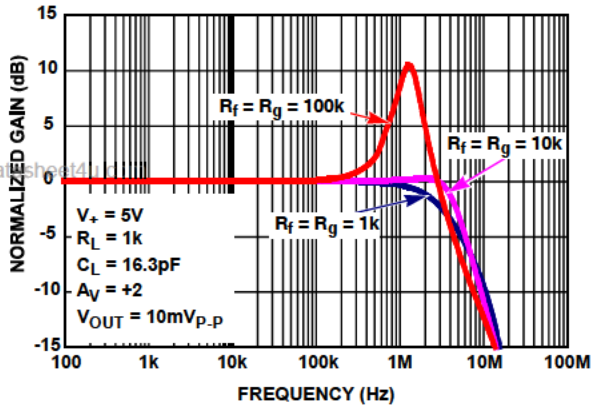

FIGURE 1. GAIN vs FREQUENCY vs FEEDBACK RESISTOR VALUES R_f/R_g

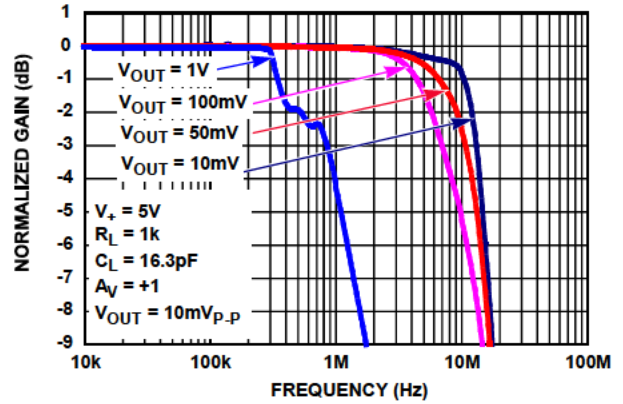

FIGURE 2. GAIN vs FREQUENCY vs V_{OUT} , $R_L = 1k$

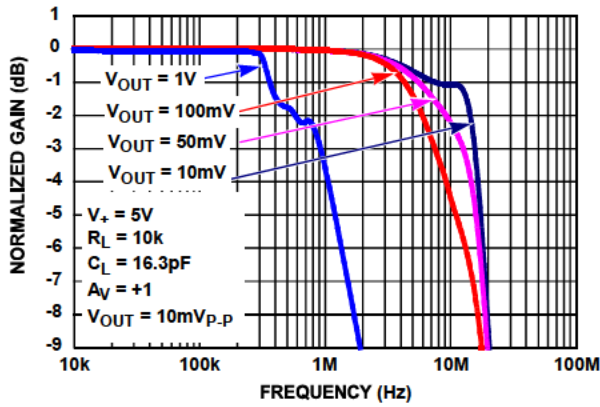

FIGURE 3. GAIN vs FREQUENCY vs V_{OUT} , $R_L = 10k$

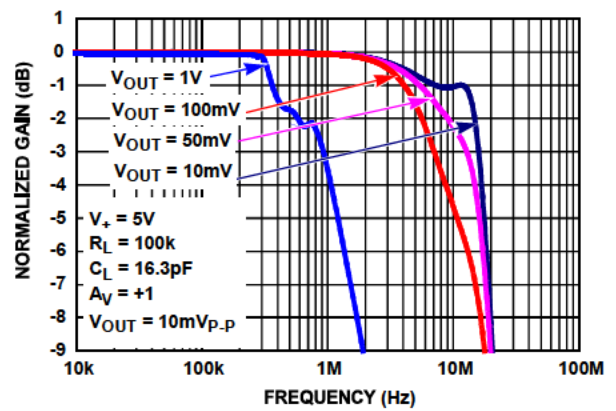

FIGURE 4. GAIN vs FREQUENCY vs V_{OUT} , $R_L = 100k$

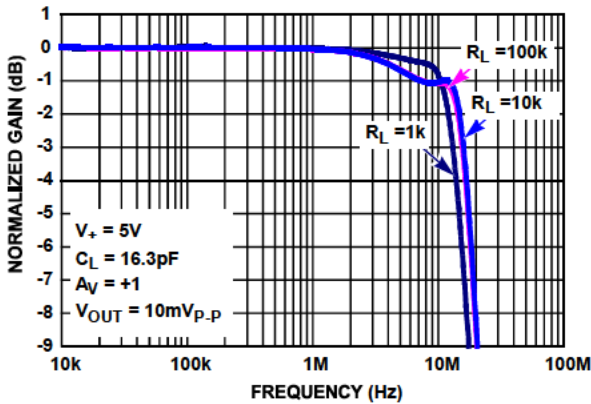

FIGURE 5. GAIN vs FREQUENCY vs R_L

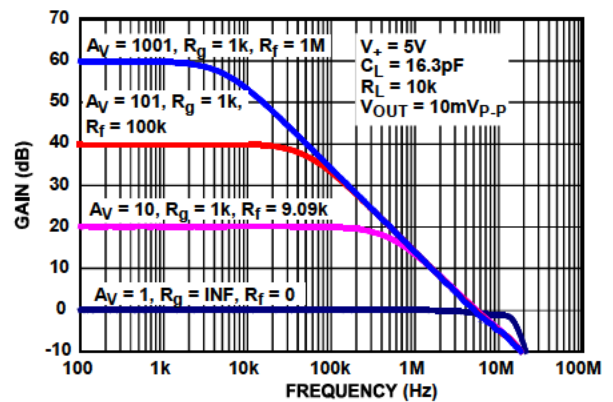

FIGURE 6. FREQUENCY RESPONSE vs CLOSED LOOP GAIN

Typical Performance Curves $V_+ = 5V, V_- = 0V, V_{CM} = 2.5V, R_L = \text{Open}$ (Continued)

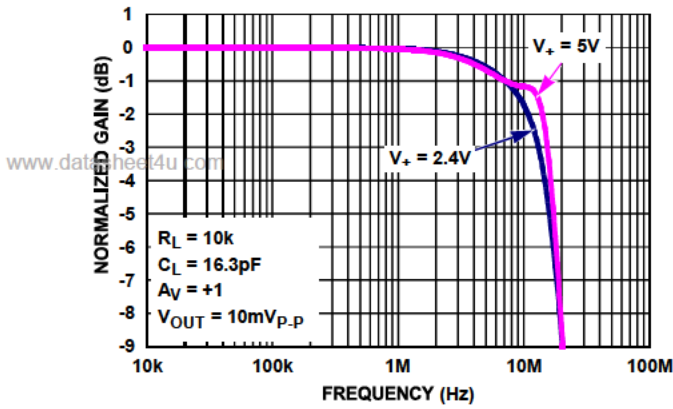

FIGURE 7. GAIN vs FREQUENCY vs SUPPLY VOLTAGE

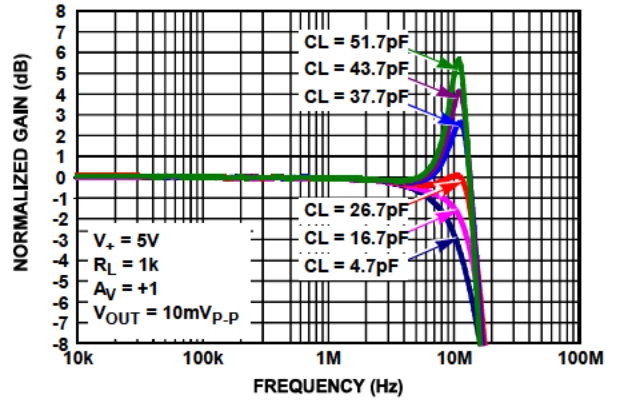

FIGURE 8. GAIN vs FREQUENCY vs C_L

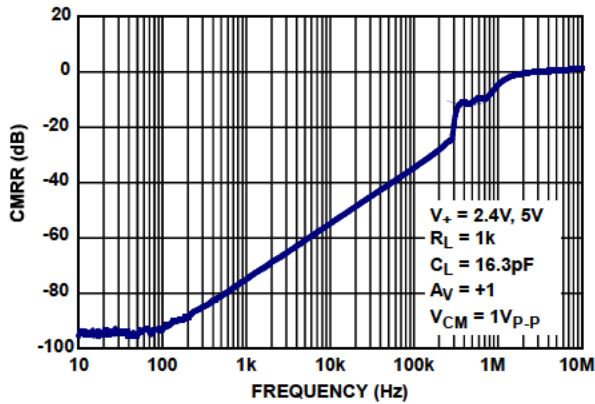

FIGURE 9. CMRR vs FREQUENCY, $V_+ = 2.4V$ and $5V$

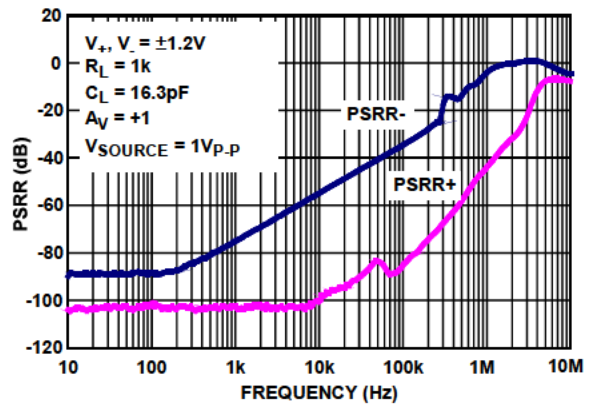

FIGURE 10. PSRR vs FREQUENCY, $V_+, V_- = \pm 1.2V$

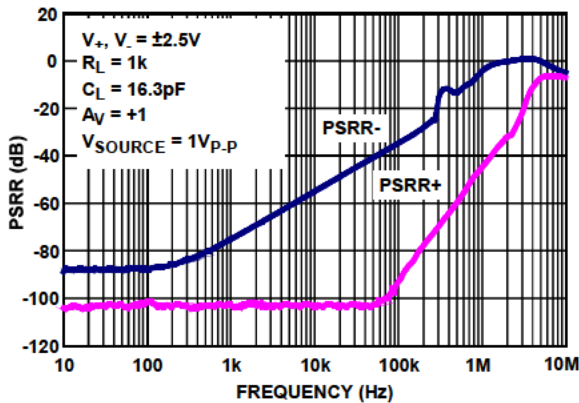

FIGURE 11. PSRR vs FREQUENCY, $V_+, V_- = \pm 2.5V$

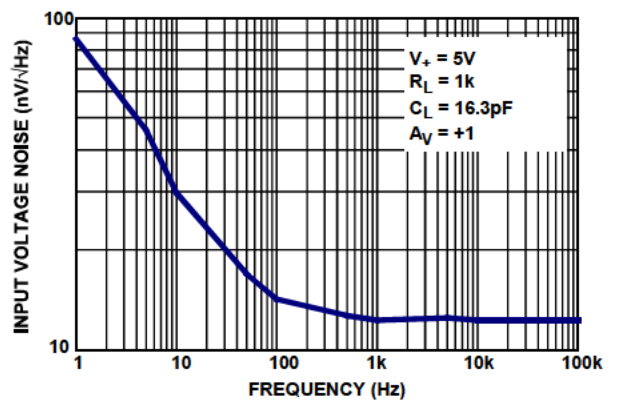

FIGURE 12. INPUT VOLTAGE NOISE DENSITY vs FREQUENCY

Typical Performance Curves $V_+ = 5V$, $V_- = 0V$, $V_{CM} = 2.5V$, $R_L = \text{Open}$ (Continued)

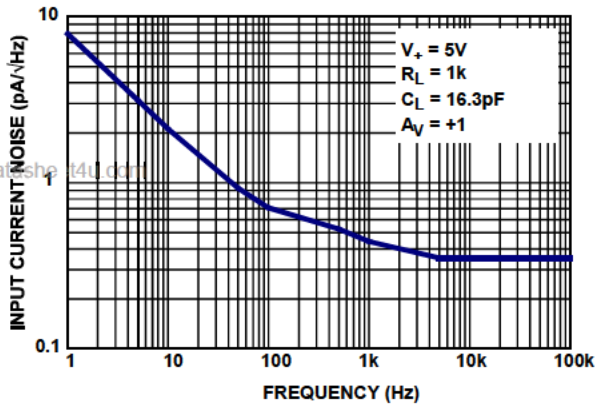

FIGURE 13. INPUT CURRENT NOISE DENSITY vs FREQUENCY

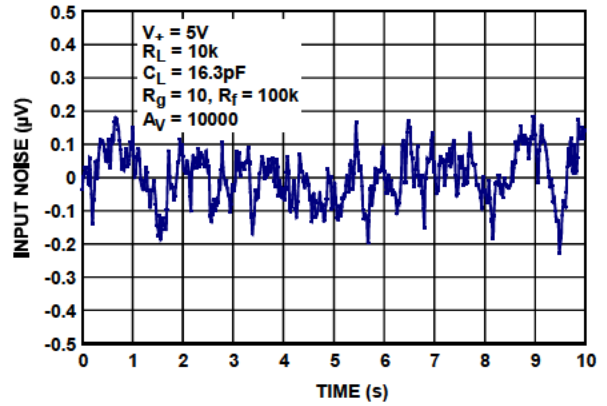

FIGURE 14. INPUT VOLTAGE NOISE 0.1Hz to 10Hz

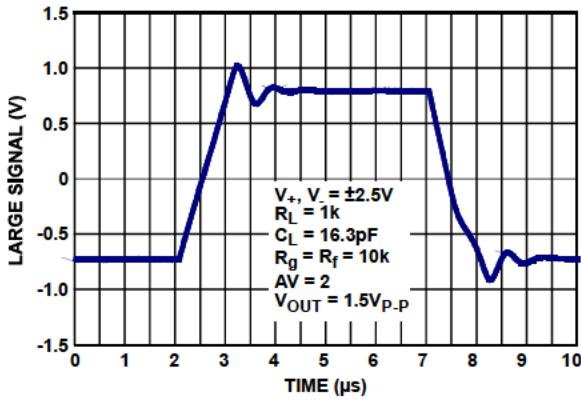

FIGURE 15. LARGE SIGNAL STEP RESPONSE

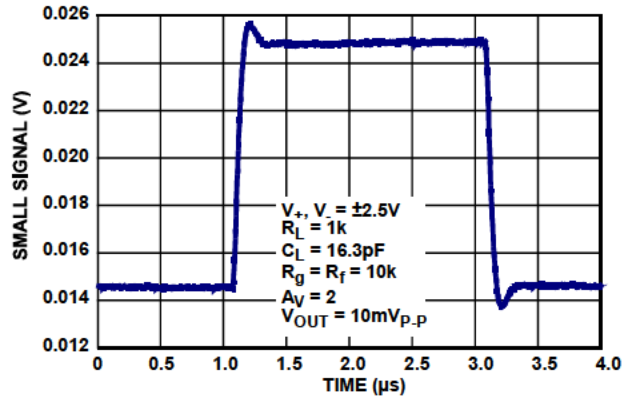

FIGURE 16. SMALL SIGNAL STEP RESPONSE

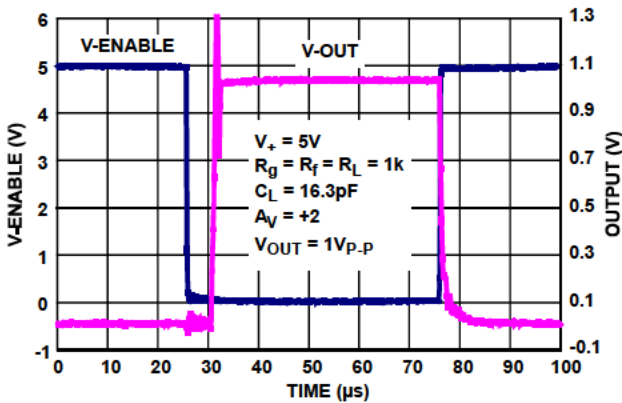

FIGURE 17. ENABLE TO OUTPUT RESPONSE

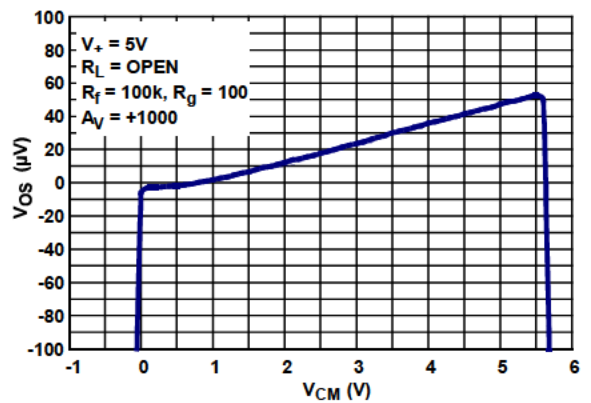

FIGURE 18. INPUT OFFSET VOLTAGE vs COMMON-MODE INPUT VOLTAGE

Typical Performance Curves $V_+ = 5V, V_- = 0V, V_{CM} = 2.5V, R_L = \text{Open}$ (Continued)

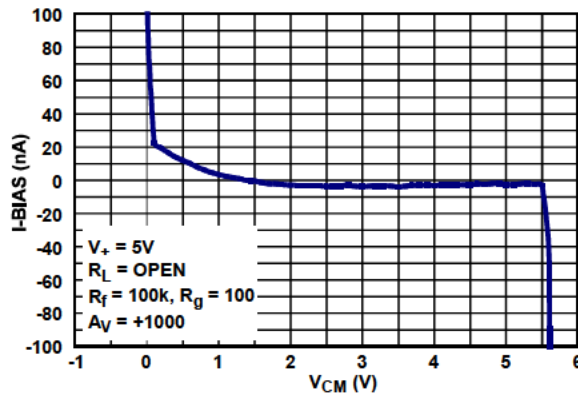

FIGURE 19. INPUT OFFSET CURRENT vs COMMON-MODE INPUT VOLTAGE

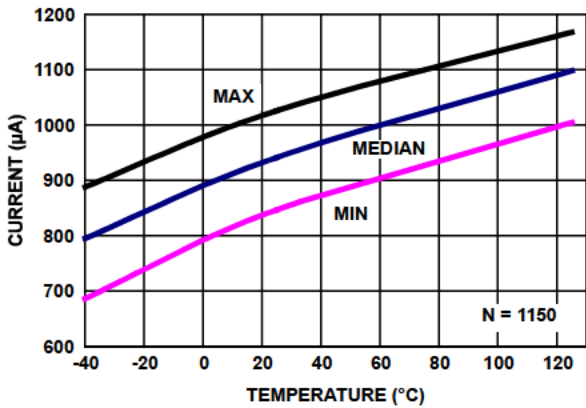

FIGURE 20. SUPPLY CURRENT ENABLED vs TEMPERATURE, $V_+, V_- = \pm 2.5V$

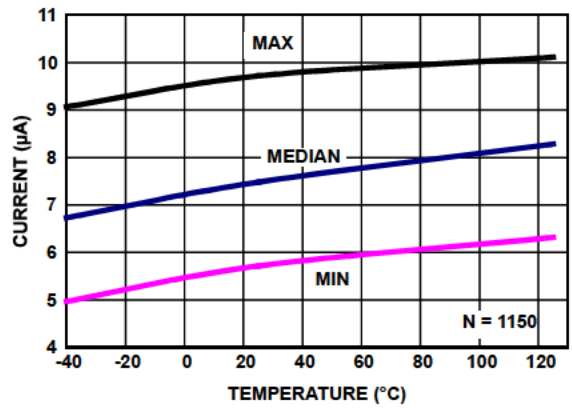

FIGURE 21. SUPPLY CURRENT DISABLED vs TEMPERATURE, $V_+, V_- = \pm 2.5V$

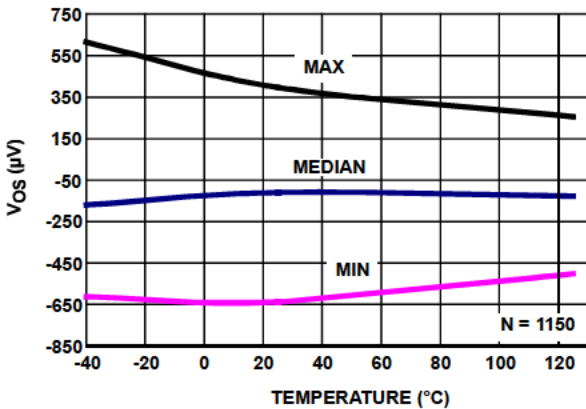

FIGURE 22. V_{OS} (SOT PKG) vs TEMPERATURE, $V_+, V_- = \pm 2.5V$

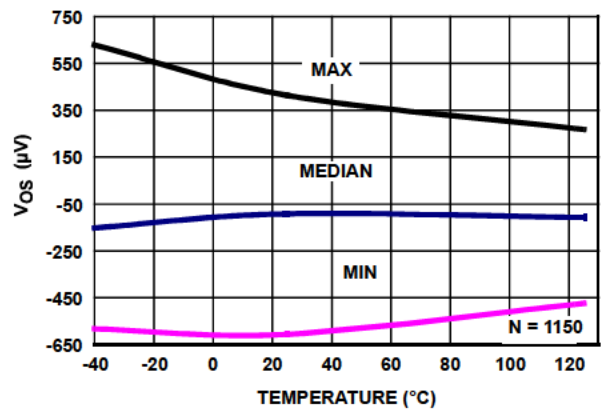

FIGURE 23. V_{OS} (SOT PKG) vs TEMPERATURE, $V_+, V_- = \pm 1.2V$

Typical Performance Curves $V_+ = 5V, V_- = 0V, V_{CM} = 2.5V, R_L = \text{Open}$ (Continued)

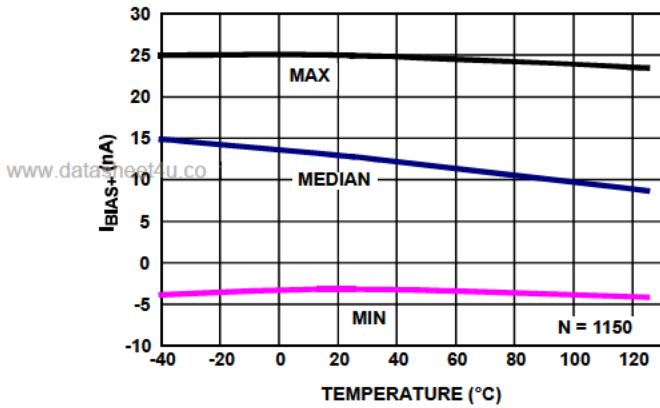

FIGURE 24. I_{BIAS+} vs TEMPERATURE, $V_+, V_- = \pm 2.5V$

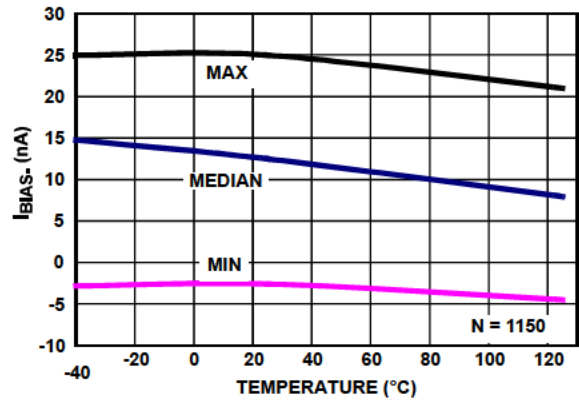

FIGURE 25. I_{BIAS-} vs TEMPERATURE, $V_+, V_- = \pm 2.5V$

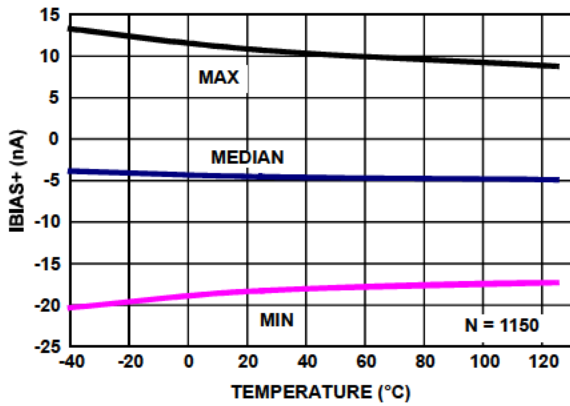

FIGURE 26. I_{BIAS+} vs TEMPERATURE, $V_+, V_- = \pm 1.2V$

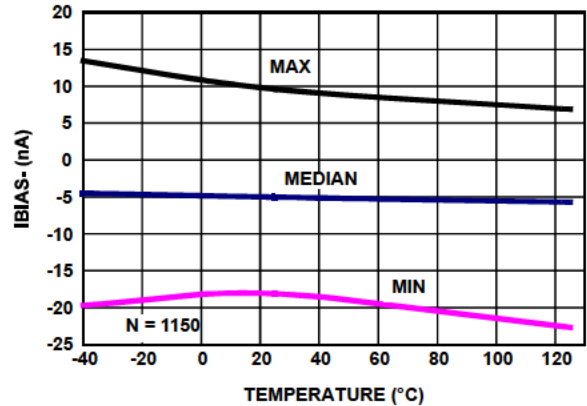

FIGURE 27. I_{BIAS-} vs TEMPERATURE, $V_+, V_- = \pm 1.2V$

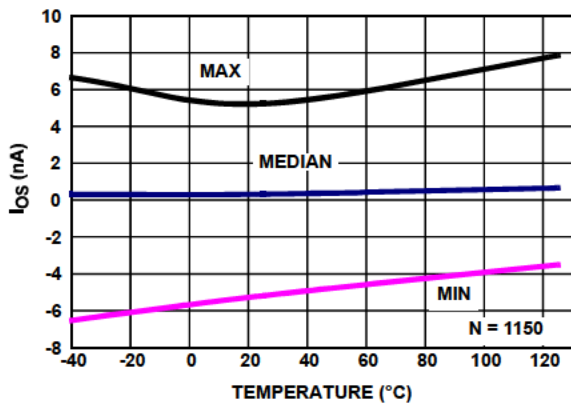

FIGURE 28. I_{OS} vs TEMPERATURE $V_+, V_- = \pm 2.5V$

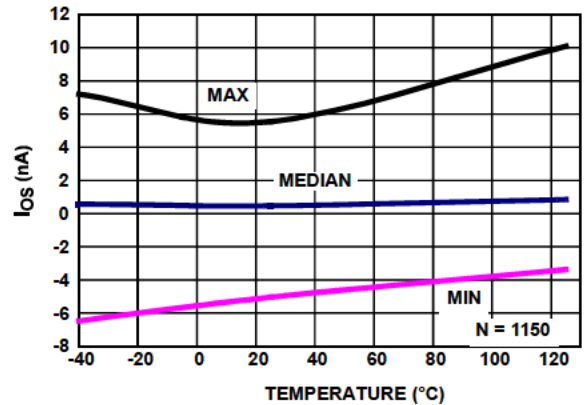

FIGURE 29. I_{OS} vs TEMPERATURE $V_+, V_- = \pm 1.2V$

Typical Performance Curves $V_+ = 5V, V_- = 0V, V_{CM} = 2.5V, R_L = \text{Open}$ (Continued)

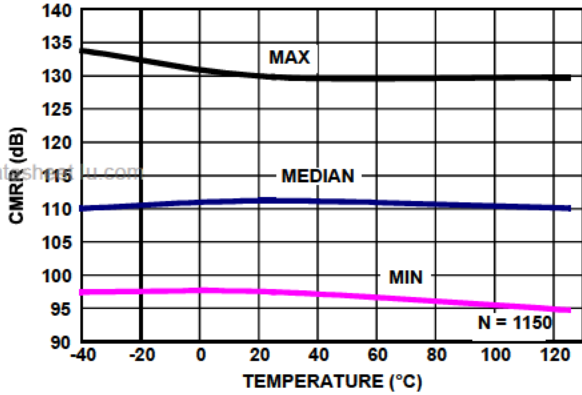

FIGURE 30. CMRR vs TEMPERATURE $V_{CM} = \bar{+}2.5V \text{ TO } -2.5V, V_+, V_- = \pm 2.5V$

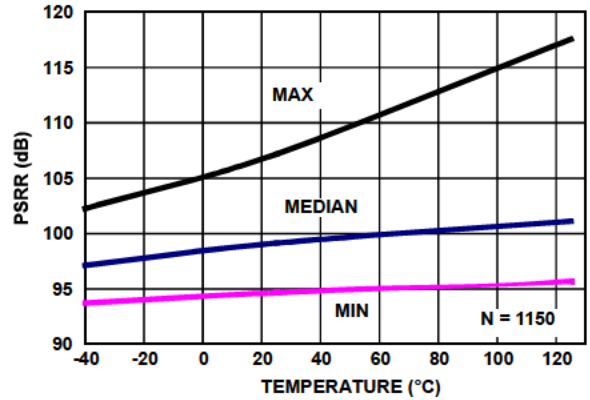

FIGURE 31. PSRR vs TEMPERATURE $V_+, V_- = \pm 1.2V \text{ TO } \pm 2.75V$

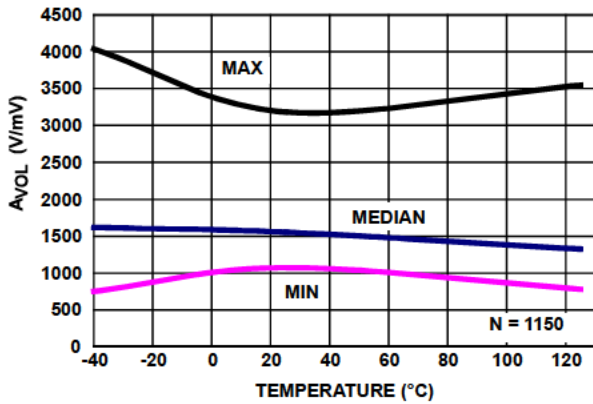

FIGURE 32. AVOL vs TEMPERATURE $V_+, V_- = \pm 2.5V, V_O = +2V, R_L = 100k$

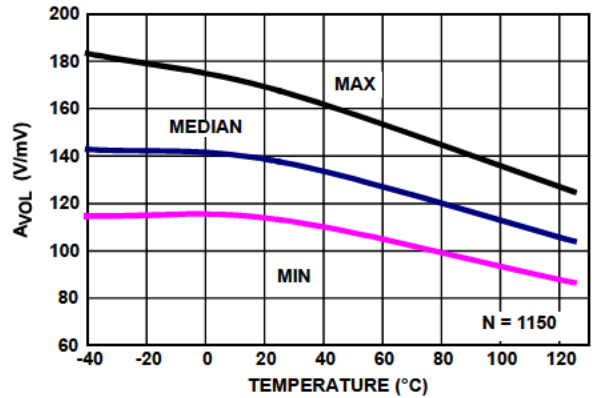

FIGURE 33. AVOL vs TEMPERATURE $V_+, V_- = \pm 2.5V, V_O = +2V, R_L = 1k$

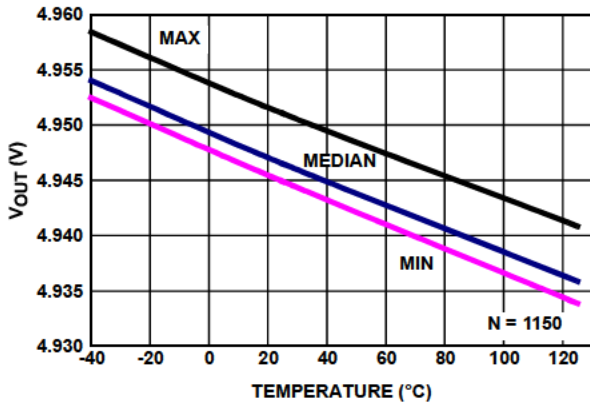

FIGURE 34. $V_{OUT \text{ HIGH}}$ vs TEMPERATURE $V_+, V_- = \pm 2.5V, R_L = 1k$

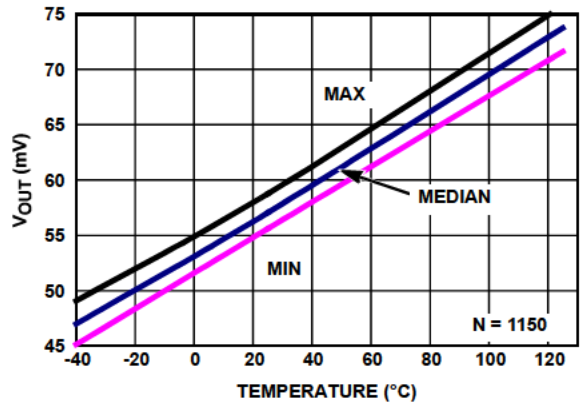
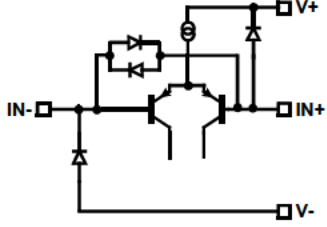
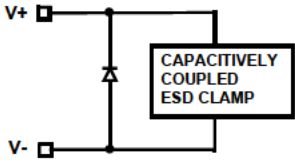
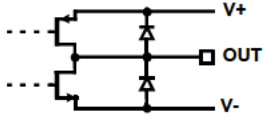
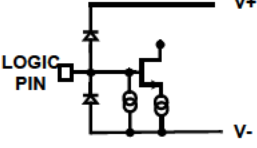

FIGURE 35. $V_{OUT \text{ LOW}}$ vs TEMPERATURE $V_+, V_- = \pm 2.5V, R_L = 1k$

Pin Descriptions

ISL28146 (6 Ld SOT-23)	ISL28246 (8 Ld SOIC) (8 Ld MSOP)	PIN NAME	FUNCTION	EQUIVALENT CIRCUIT
4	2 (A) 6 (B)	IN- IN-_A IN-_B	Inverting input	 <p>Circuit 1</p>
3	3 (A) 5 (B)	IN+ IN+_A IN+_B	Non-inverting input	See Circuit 1
2	4	V-	Negative supply	 <p>Circuit 2</p>
1	1 (A) 7 (B)	OUT OUT_A OUT_B	Output	 <p>Circuit 3</p>
6	8	V+	Positive supply	See Circuit 2
5		$\overline{\text{EN}}$	Chip enable	 <p>Circuit 3</p>

Applications Information

Introduction

The ISL28146 and ISL28246 are single and dual channel rail-to-rail input, output (RRIO) micropower precision operational amplifiers. The parts are designed to operate from single supply (2.4V to 5.0V) or dual supply ($\pm 1.2V$ to $\pm 2.75V$). The parts have an input common mode range that extends 0.25V above the positive rail and down to the negative supply rail. The output operation can swing within about 3mV of the supply rails with a 100k Ω load.

Rail-to-Rail Input

Many rail-to-rail input stages use two differential input pairs, a long-tail PNP (or PFET) and an NPN (or NFET). Severe penalties have to be paid for this circuit topology. As the input signal moves from one supply rail to another, the operational amplifier switches from one input pair to the other causing drastic changes in input offset voltage and an undesired change in magnitude and polarity of input offset current.

The ISL28146 and ISL28246 achieve input rail-to-rail operation without sacrificing important precision specifications and degrading distortion performance. The devices' input offset voltage exhibits a smooth behavior throughout the entire common-mode input range. The input bias current versus the common-mode voltage range gives an undistorted behavior from typically down to the negative rail and up to 0.25V higher than the V+ rail.

Rail-to-Rail Output

A pair of complementary MOS devices are used to achieve the rail-to-rail output swing. The NMOS sinks current to swing the output in the negative direction. The PMOS sources current to swing the output in the positive direction. The ISL28146 and ISL28246 with a 100k Ω load will swing to within 3mV of the positive supply rail and within 3mV of the negative supply rail.

Results of Over-Driving the Output

Caution should be used when over-driving the output for long periods of time. Over-driving the output can occur in two ways:

1. The input voltage times the gain of the amplifier exceeds the supply voltage by a large value or,
2. The output current required is higher than the output stage can deliver. These conditions can result in a shift in the Input Offset Voltage (V_{OS}) as much as 1 $\mu V/hr.$ of exposure under these conditions.

IN+ and IN- Input Protection

All input terminals have internal ESD protection diodes to both positive and negative supply rails, limiting the input voltage to within one diode beyond the supply rails. They also contain back-to-back diodes across the input terminals ("Pin Descriptions" on page 10 - Circuit 1). For applications where the input differential voltage is expected to exceed 0.5V, an

external series resistor must be used to ensure the input currents never exceed 5mA (Figure 36).

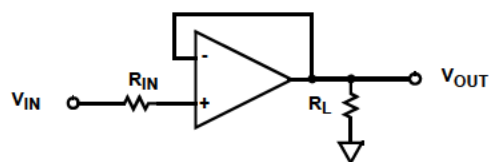

FIGURE 36. INPUT CURRENT LIMITING

Enable/Disable Feature

The ISL28146 offers an \overline{EN} pin that disables the device when pulled up to at least 2.0V. In the disabled state (output in a high impedance state), the part consumes typically 10 μA at room temperature. The \overline{EN} pin has an internal pull-down. If left open, the \overline{EN} pin will pull to the negative rail and the device will be enabled by default. When not used, the \overline{EN} pin should either be left floating or connected directly to the -V pin.

By disabling the part, multiple ISL28146 parts can be connected together as a MUX. In this configuration, the outputs are tied together in parallel and a channel can be selected by the \overline{EN} pin. The loading effects of the feedback resistors of the disabled amplifier must be considered when multiple amplifier outputs are connected together. Note that feed through from the IN+ to IN- pins occurs on any Mux Amp disabled channel where the input differential voltage exceeds 0.5V (e.g., active channel $V_{OUT} = 1V$, while disabled channel $V_{IN} = GND$), so the mux implementation is best suited for small signal applications. If large signals are required, use series IN+ resistors, or a large value R_F , to keep the feed through current low enough to minimize the impact on the active channel. See "Limitations of the Differential Input Protection" on page 11.

Limitations of the Differential Input Protection

If the input differential voltage is expected to exceed 0.5V, an external current limiting resistor must be used to ensure the input current never exceeds 5mA. For non-inverting unity gain applications, the current limiting can be via a series IN+ resistor, or via a feedback resistor of appropriate value. For other gain configurations, the series IN+ resistor is the best choice, unless the feedback (R_F) and gain setting (R_G) resistors are both sufficiently large to limit the input current to 5mA.

Large differential input voltages can arise from several sources:

1. During open loop (comparator) operation. Used this way, the IN+ and IN- voltages don't track, so differentials arise.
2. When the amplifier is disabled but an input signal is still present. An R_L or R_G to GND keeps the IN- at GND, while the varying IN+ signal creates a differential voltage. Mux Amp applications are similar, except that the active channel V_{OUT} determines the voltage on the IN- terminal.
3. When the slew rate of the input pulse is considerably faster than the op amp's slew rate. If the V_{OUT} can't keep

up with the IN+ signal, a differential voltage results, and visible distortion occurs on the input and output signals. To avoid this issue, keep the input slew rate below 1.9V/μs, or use appropriate current limiting resistors.

Large (>2V) differential input voltages can also cause an increase in disabled I_{CC}.

Using Only One Channel

The ISL28246 is a dual op amp. If the application only requires one channel, the user must configure the unused channel to prevent it from oscillating. The unused channel will oscillate if the input and output pins are floating. This will result in higher than expected supply currents and possible noise injection into the channel being used. The proper way to prevent this oscillation is to short the output to the negative input and ground the positive input (Figure 37).

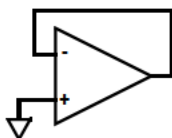

FIGURE 37. PREVENTING OSCILLATIONS IN UNUSED CHANNELS

Current Limiting

These devices have no internal current-limiting circuitry. If the output is shorted, it is possible to exceed the Absolute Maximum Rating for output current or power dissipation, potentially resulting in the destruction of the device.

Power Dissipation

It is possible to exceed the +125°C maximum junction temperatures under certain load and power-supply conditions. It is therefore important to calculate the maximum junction temperature (T_{JMAX}) for all applications to determine if power supply voltages, load conditions, or package type need to be modified to remain in the safe operating area. These parameters are related using Equation 1:

$$T_{JMAX} = T_{MAX} + (\theta_{JA} \times PD_{MAXTOTAL}) \quad (EQ. 1)$$

where:

- PD_{MAXTOTAL} is the sum of the maximum power dissipation of each amplifier in the package (PD_{MAX})
- PD_{MAX} for each amplifier can be calculated using Equation 2:

$$PD_{MAX} = 2 \times V_S \times I_{SMAX} + (V_S - V_{OUTMAX}) \times \frac{V_{OUTMAX}}{R_L} \quad (EQ. 2)$$

where:

- T_{MAX} = Maximum ambient temperature
- θ_{JA} = Thermal resistance of the package
- PD_{MAX} = Maximum power dissipation of 1 amplifier
- V_S = Supply voltage (Magnitude of V₊ and V₋)
- I_{SMAX} = Maximum supply current of 1 amplifier
- V_{OUTMAX} = Maximum output voltage swing of the application
- R_L = Load resistance

SOT-23 Package Family

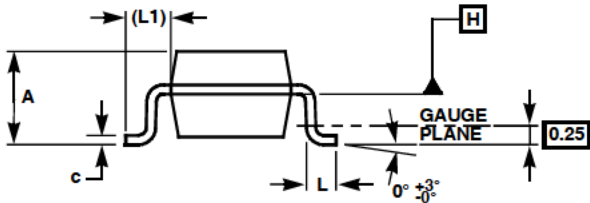
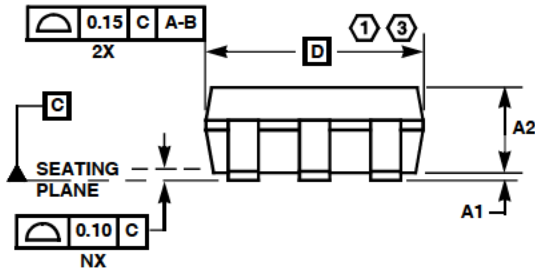
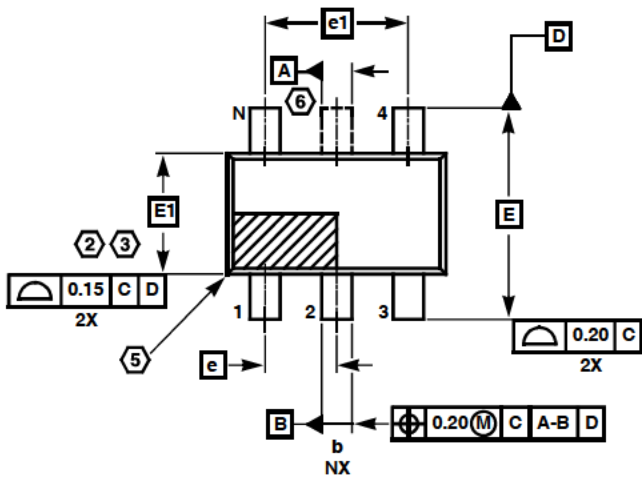

MDP0038

SOT-23 PACKAGE FAMILY

SYMBOL	MILLIMETERS		TOLERANCE
	SOT23-5	SOT23-6	
A	1.45	1.45	MAX
A1	0.10	0.10	±0.05
A2	1.14	1.14	±0.15
b	0.40	0.40	±0.05
c	0.14	0.14	±0.06
D	2.90	2.90	Basic
E	2.80	2.80	Basic
E1	1.60	1.60	Basic
e	0.95	0.95	Basic
e1	1.90	1.90	Basic
L	0.45	0.45	±0.10
L1	0.60	0.60	Reference
N	5	6	Reference

Rev. F 2/07

NOTES:

1. Plastic or metal protrusions of 0.25mm maximum per side are not included.
2. Plastic interlead protrusions of 0.25mm maximum per side are not included.
3. This dimension is measured at Datum Plane "H".
4. Dimensioning and tolerancing per ASME Y14.5M-1994.
5. Index area - Pin #1 I.D. will be located within the indicated zone (SOT23-6 only).
6. SOT23-5 version has no center lead (shown as a dashed line).

Small Outline Package Family (SO)

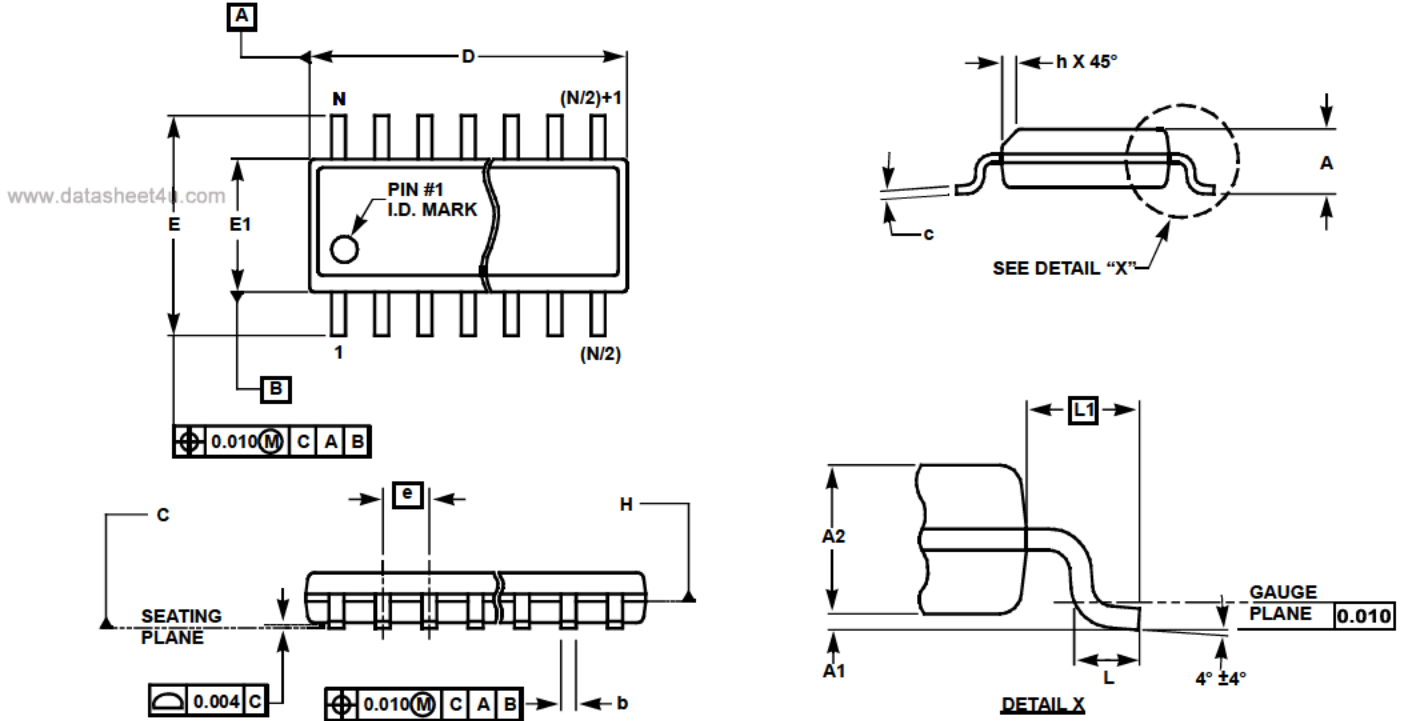

MDP0027

SMALL OUTLINE PACKAGE FAMILY (SO)

SYMBOL	INCHES							TOLERANCE	NOTES
	SO-8	SO-14	SO16 (0.150")	SO16 (0.300") (SOL-16)	SO20 (SOL-20)	SO24 (SOL-24)	SO28 (SOL-28)		
A	0.068	0.068	0.068	0.104	0.104	0.104	0.104	MAX	-
A1	0.006	0.006	0.006	0.007	0.007	0.007	0.007	± 0.003	-
A2	0.057	0.057	0.057	0.092	0.092	0.092	0.092	± 0.002	-
b	0.017	0.017	0.017	0.017	0.017	0.017	0.017	± 0.003	-
c	0.009	0.009	0.009	0.011	0.011	0.011	0.011	± 0.001	-
D	0.193	0.341	0.390	0.406	0.504	0.606	0.704	± 0.004	1, 3
E	0.236	0.236	0.236	0.406	0.406	0.406	0.406	± 0.008	-
E1	0.154	0.154	0.154	0.295	0.295	0.295	0.295	± 0.004	2, 3
e	0.050	0.050	0.050	0.050	0.050	0.050	0.050	Basic	-
L	0.025	0.025	0.025	0.030	0.030	0.030	0.030	± 0.009	-
L1	0.041	0.041	0.041	0.056	0.056	0.056	0.056	Basic	-
h	0.013	0.013	0.013	0.020	0.020	0.020	0.020	Reference	-
N	8	14	16	16	20	24	28	Reference	-

Rev. M 2/07

NOTES:

1. Plastic or metal protrusions of 0.006" maximum per side are not included.
2. Plastic interlead protrusions of 0.010" maximum per side are not included.
3. Dimensions "D" and "E1" are measured at Datum Plane "H".
4. Dimensioning and tolerancing per ASME Y14.5M-1994

Mini SO Package Family (MSOP)

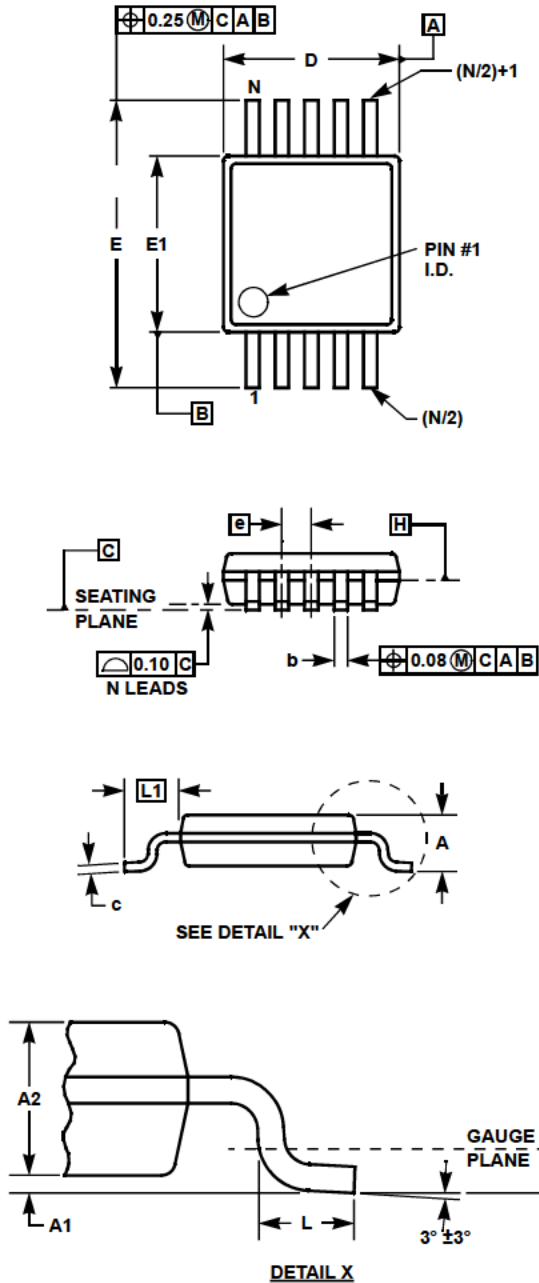

MDP0043
MINI SO PACKAGE FAMILY

SYMBOL	MILLIMETERS		TOLERANCE	NOTES
	MSOP8	MSOP10		
A	1.10	1.10	Max.	-
A1	0.10	0.10	±0.05	-
A2	0.86	0.86	±0.09	-
b	0.33	0.23	+0.07/-0.08	-
c	0.18	0.18	±0.05	-
D	3.00	3.00	±0.10	1, 3
E	4.90	4.90	±0.15	-
E1	3.00	3.00	±0.10	2, 3
e	0.65	0.50	Basic	-
L	0.55	0.55	±0.15	-
L1	0.95	0.95	Basic	-
N	8	10	Reference	-

Rev. D 2/07

NOTES:

1. Plastic or metal protrusions of 0.15mm maximum per side are not included.
2. Plastic interlead protrusions of 0.25mm maximum per side are not included.
3. Dimensions "D" and "E1" are measured at Datum Plane "H".
4. Dimensioning and tolerancing per ASME Y14.5M-1994.

All Intersil U.S. products are manufactured, assembled and tested utilizing ISO9000 quality systems.
Intersil Corporation's quality certifications can be viewed at www.intersil.com/design/quality

Intersil products are sold by description only. Intersil Corporation reserves the right to make changes in circuit design, software and/or specifications at any time without notice. Accordingly, the reader is cautioned to verify that data sheets are current before placing orders. Information furnished by Intersil is believed to be accurate and reliable. However, no responsibility is assumed by Intersil or its subsidiaries for its use; nor for any infringements of patents or other rights of third parties which may result from its use. No license is granted by implication or otherwise under any patent or patent rights of Intersil or its subsidiaries.

For information regarding Intersil Corporation and its products, see www.intersil.com

Looking for pricing, stock, or lifecycle information?

Click below to explore more details on WIN SOURCE:

-  [View ISL28246FBZ-T7 on WIN SOURCE](#)
-  [Renesas Electronics America](#) Information

Optimize Your Supply Chain with WIN SOURCE Solutions

-  Global Sourcing Solution
-  Obsolete Management
-  Cost Control Management
-  Shortage Management
-  Alternative Solution
-  Excess Inventory Management