



EV2660-C-01A

Evaluation Board of 500mA Linear Charger with PPM for SingleCell Li-ion Battery

The Future of Analog IC Technology®

DESCRIPTION

The EV2660-C-01A is an evaluation board for the MP2660, a highly-integrated single-cell Li-Ion/Li-Polymer battery charger with system power path management, targeted at space limited portable applications.

Through the I2C connector on EV2660-C-01A, the customer can program the charging parameters, such as: input current limit, input voltage regulation limit, charging current, battery regulation voltage, and battery UVLO.

ELECTRICAL SPECIFICATION

Parameter	Symbol	Value	Units
Input Voltage	V_{IN}	4.35 - 5.50	V
Battery Voltage	V_{BATT_REG}	3.60 - 4.545 (Default: 4.20)	V
Input Current Limit	I_{IN_LIMIT}	85 - 455 (Default: 455)	mA
V_{IN} Regulation Voltage ⁽¹⁾	V_{IN_REG}	3.88-5.08 (Default: 4.60)	V
Charge Current	I_{CHG}	8 - 535 (Default: 246)	mA
Discharge Current Limit	I_{BATT_MAX}	100 - 1600 (Default: 1000)	mA

Note: (1) suggest V_{IN_REG} is 400mV higher than V_{BATT} .

FEATURES

- Fully Autonomous Charging a Single-Cell Li-Ion/Polymer Batteries
- Current Limit for USB Port
- Complete Power Path Management for Simultaneously Powering the System and Charging the Battery
- 0.5% Charging Voltage Accuracy
- 13V Maximum Voltage for the Input Source
- I²C Interface for Setting charging Parameters and Status Reporting
- Robust Charging Protection Including Battery Temperature Monitor and Programmable Timer
- Battery Disconnection Function when battery UVLO or system short circuit

APPLICATIONS

- Wearable devices
- Smart Handheld Devices
- Fitness Accessories
- Smart Watches

All MPS parts are lead-free, halogen free, and adhere to the RoHS directive. For MPS green status, please visit MPS website under Quality Assurance.

"MPS" and "The Future of Analog IC Technology" are Registered Trademarks of Monolithic Power Systems, Inc.

EV2660-C-01A EVALUATION BOARD

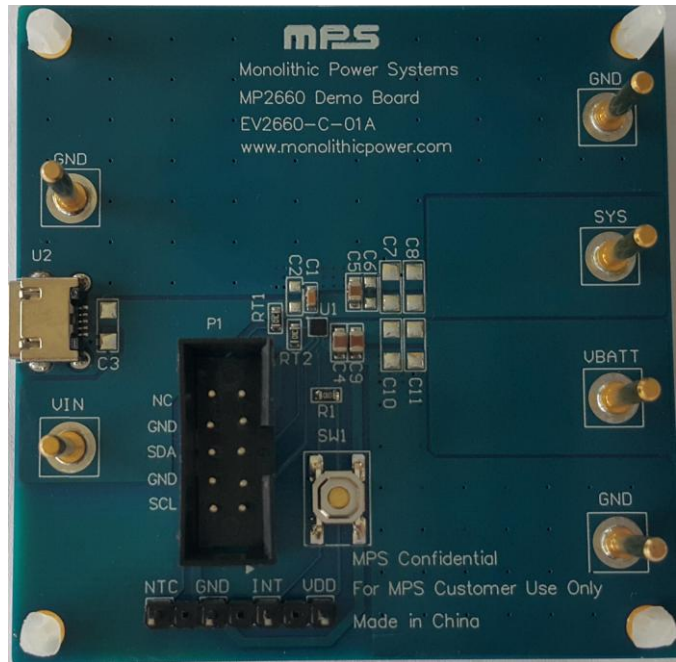

(L x W x H) 2.5" x 2.5" x 0.063"
(6.35cm x 6.35cm x 0.16cm)

Board Number	MPS IC Number
EV2660-C-01A	MP2660GC-xxxx*

*: "xxxx" is the register setting option. The factory default is "0000". This content can be viewed in I²C register map. For customer options, please contact an MPS FAE to obtain an "XXXX" value.

EVALUATION BOARD SCHEMATIC

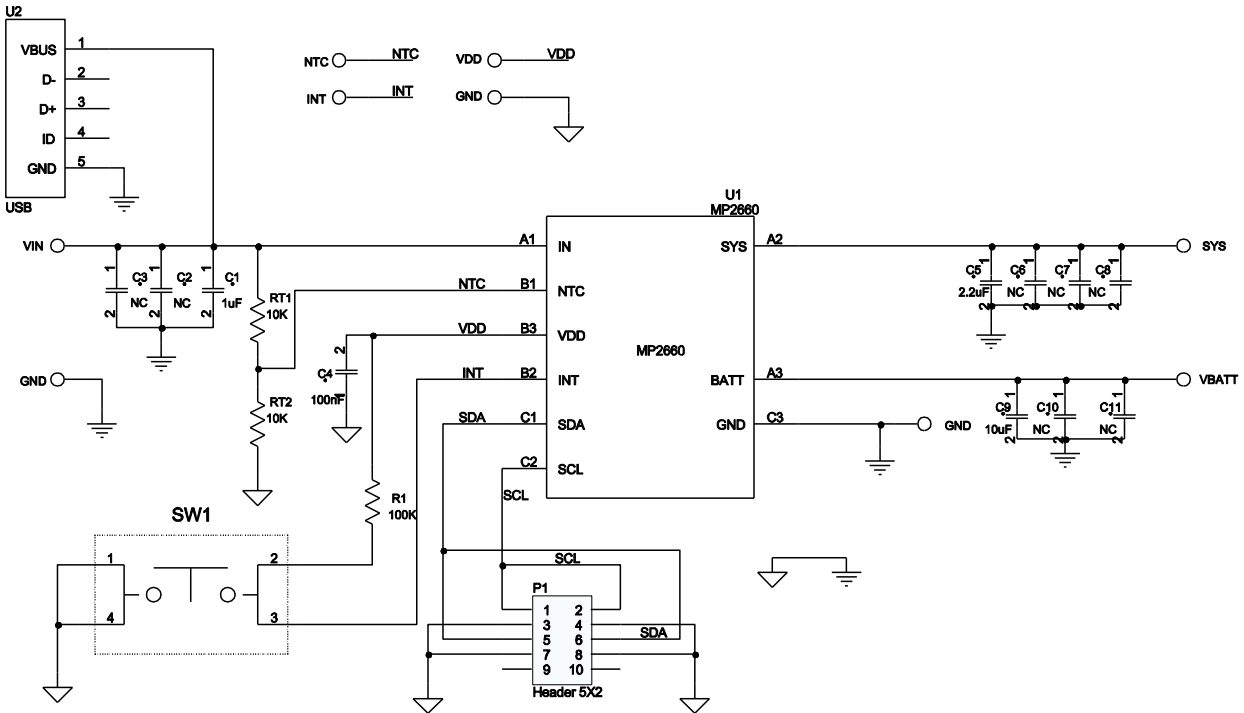

EV2660-C-01A BILL OF MATERIALS

Qty	Ref	Value	Description	Package	Manufacture	Manufacture_PN
1	C1	1 μ F	Ceramic Capacitor; 25V;X7R;0603;	0603	muRata	GRM188R71E105KA12D
1	C5	2.2 μ F	Ceramic Capacitor; 25V;X7R;0805;	0805	muRata	GRM21BR71E225KA73L
1	C9	10 μ F	Capacitor;10V;X7R	0805	TDK	C2012X7R1A106K
1	C4	100nF	Ceramic Capacitor; 100V;X7R;0805	0805	TDK	C2012X7R2A104K
2	C2, C6	NC	Ceramic Capacitor; 25V;X7R;0805;	0805	muRata	GRM21BR71E225KA73L
5	C3, C7, C8, C10, C11	NC	Ceramic Capacitor;25V;X7R;1206	1206	muRata	GRM31CR71E475KA88L
1	P1		Header, 5-Pin, Dual row			
1	R1	100k	Film Resistor;1%;	0603	Yageo	RC0603FR-07100KL
2	RT1, RT2	10k	Film Resistor;1%;	0603	Yageo	RC0603FR-0710KL
1	SW1	Push Switching button	Button;SM 4x10mm; 1.5mm Height			
1	U2		Micro-B USB connector;			
1	U1	IC	WCSP 1.55mm*1.55mm		MPS	MP2660GC-xxxx

PRINTED CIRCUIT BOARD LAYOUT

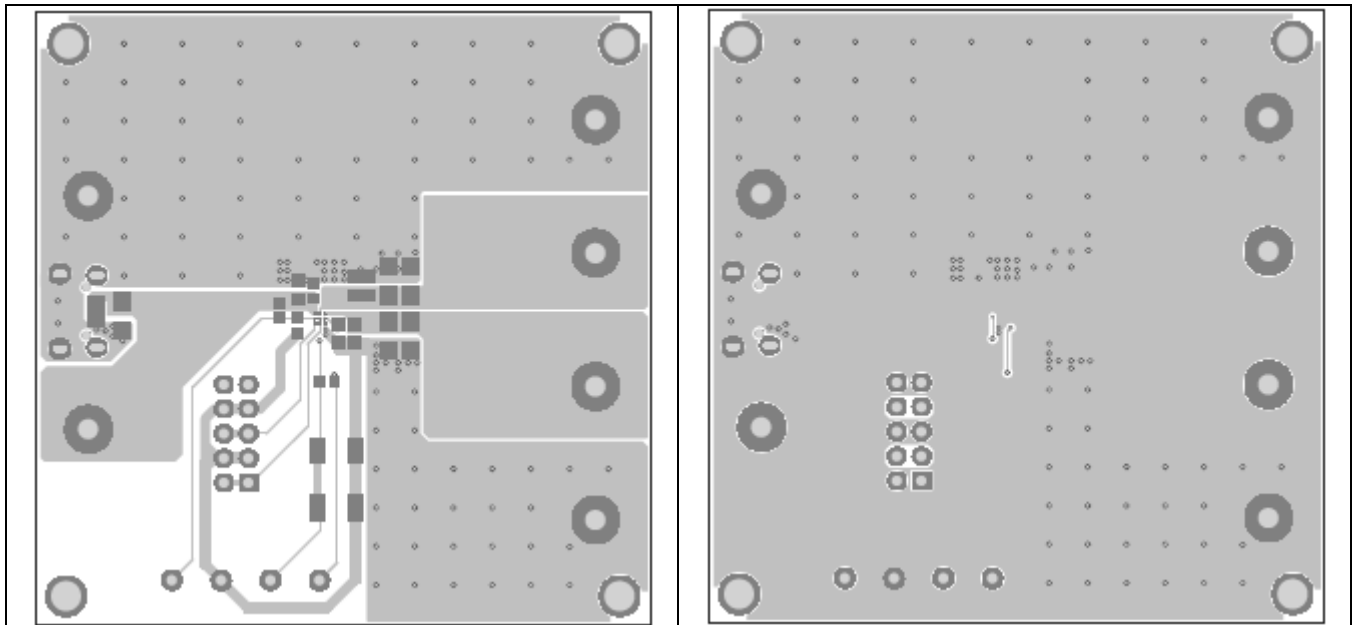

Figure1 Top Layer

Figure2 Bottom Layer

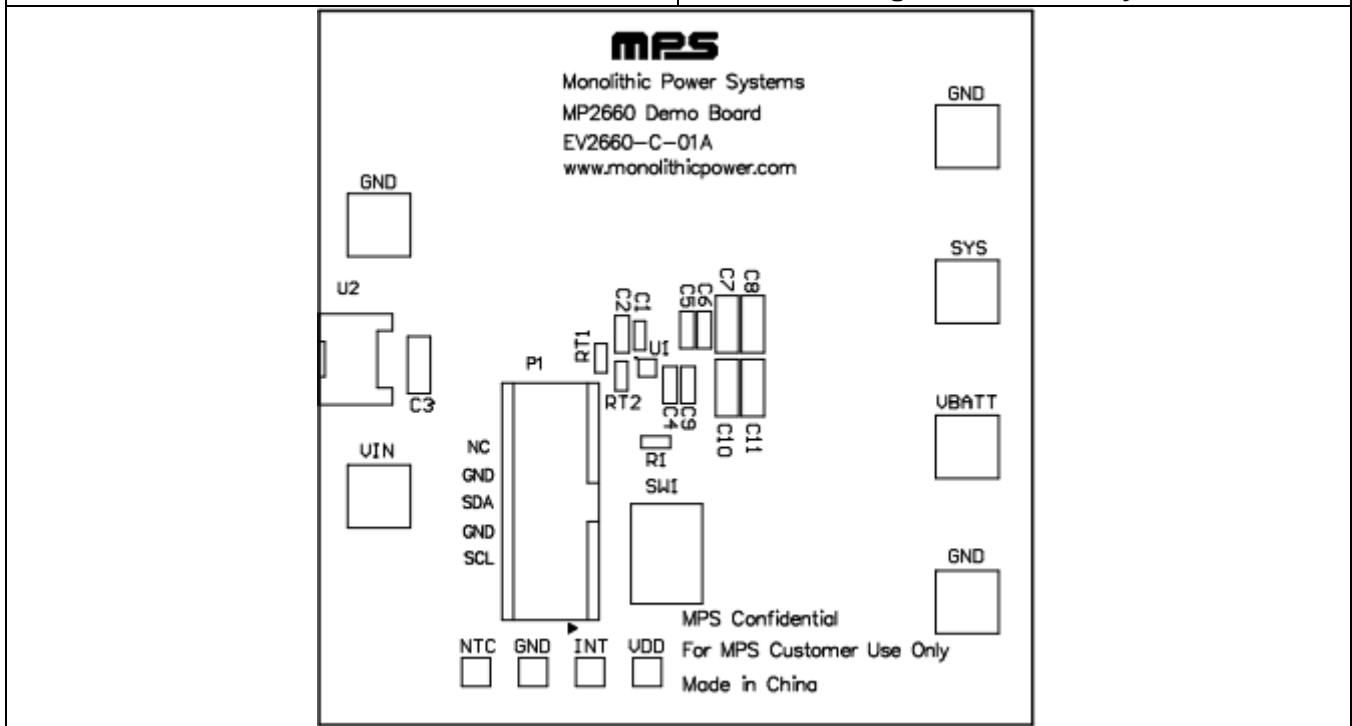

Figure3 Top Silk Layer

QUICK START GUIDE

This board is designed for MP2660 which is a highly-integrated single-cell Li-Ion/Li-Polymer battery charger with system power path management function. And layout accommodates most commonly used capacitors. The default function of this board is preset for charger mode and the charge full voltage is preset to 4.200V for 1 cell Li-Ion battery.

Evaluation Platform Preparation:

1) USB-to-I²C Communication Kit

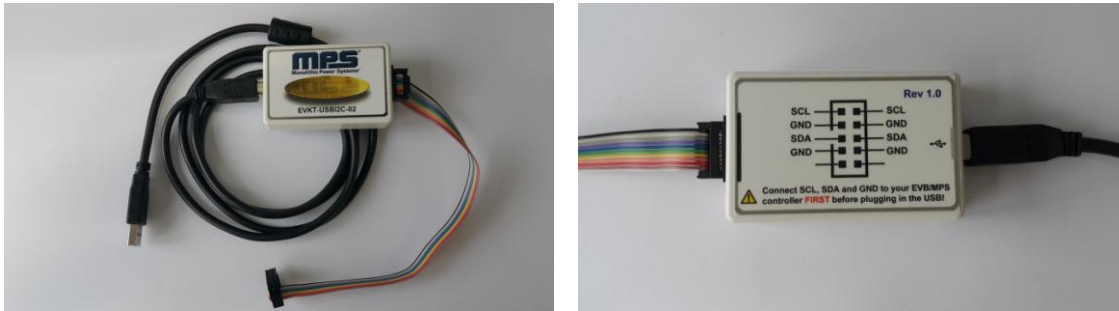

Figure4 USB-to-I²C Communication Kit

2) Software - Double-click on the MP2660_R1.6.EXE file and open the software. The software supports the Windows® XP operating systems.



3) A computer with at least one USB port and a USB cable. The MP2660 evaluation software must be properly installed.

4) Original Test Setup for MP2660 in Figure 5.

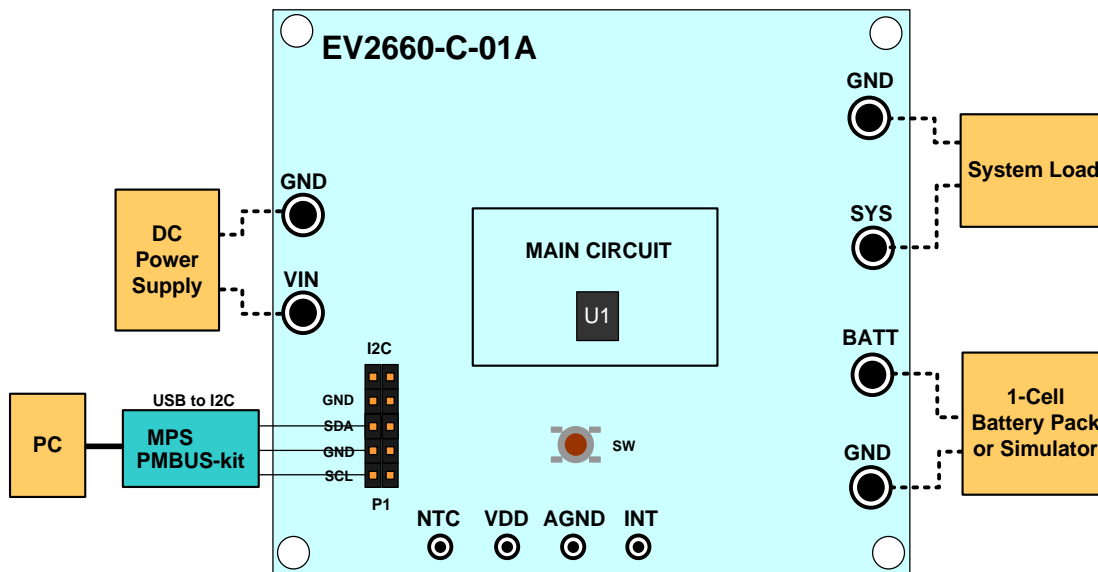

Figure5 Test Setup for MP2660

5) Turn on the computer. Launch the MP2660 evaluation software. The main window of the software is shown in Figure 6.

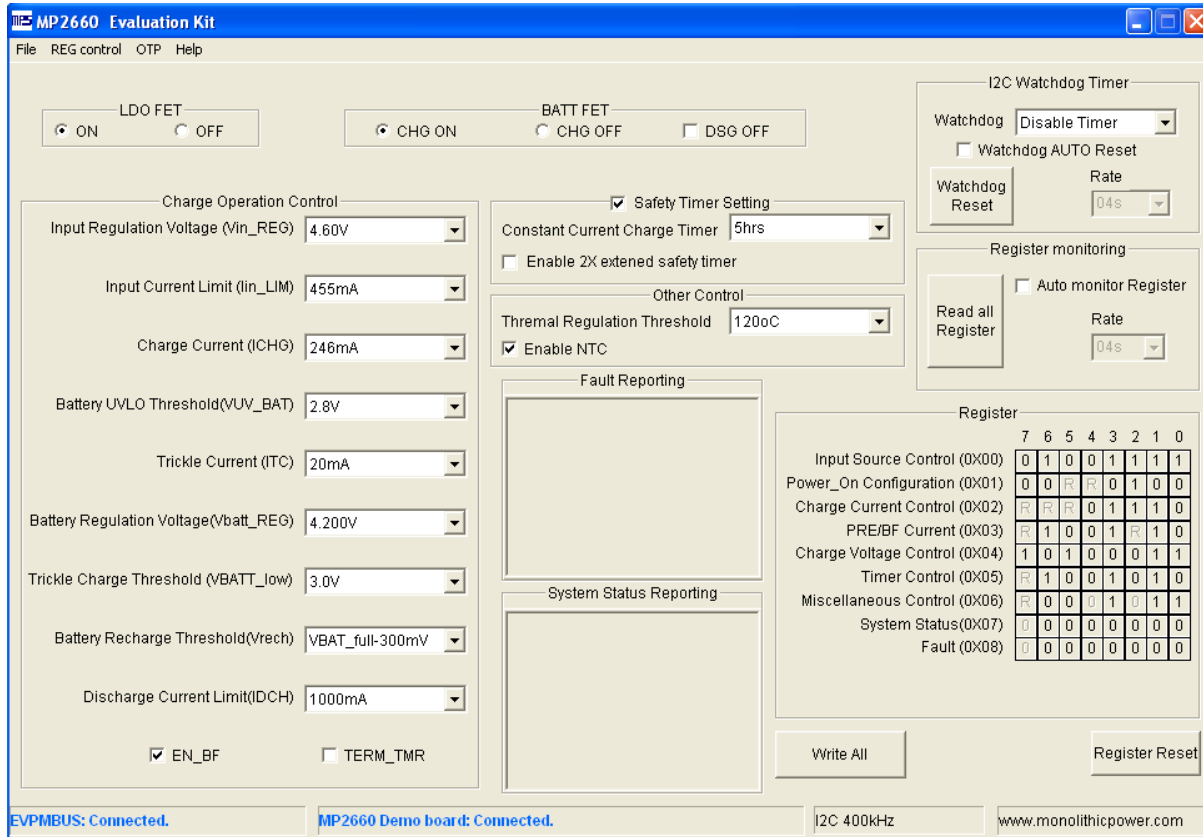

Figure6 MP2660evaluation software

Procedure

Make sure all the connections are normal -- the EVPMBUS connected and EV2660-C-01A connected. It is ready to run the program!

Charger Function

Charge Operation Control	
Input Regulation Voltage (Vin_REG)	4.60V
Input Current Limit (Iin_LIM)	455mA
Charge Current (ICHG)	246mA
Battery UVLO Threshold(VUV_BAT)	2.8V
Trickle Current (ITC)	20mA
Battery Regulation Voltage(Vbatt_REG)	4.200V
Trickle Charge Threshold (VBATT_low)	3.0V
Battery Recharge Threshold(Vrech)	VBAT_full-300mV
Discharge Current Limit(IDCH)	1000mA
<input checked="" type="checkbox"/> EN_BF	<input type="checkbox"/> TERM_TMR

1. Set Input Voltage Regulation at 4.60 V (the range is 3.88 - 5.08V, which is recommended 400mV higher than the Battery Regulation Voltage)

Input Regulation Voltage (Vin_REG)	4.60V
	4.60V
	4.68V
	4.76V
	4.84V
	4.92V
	5.00V
	5.08V

2. Set Input Current Limit to 455 mA (the range is 85 – 455mA)

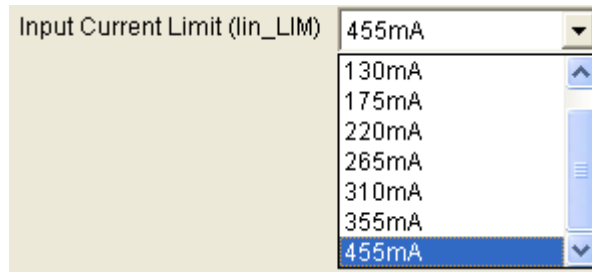

The input current limit can be set to be a little bit lower than the max current rating of the input source. When input current hits the limit the charge current will be decreased to keep the input current constant at this limit, in order to power the system firstly.

3. Set Constant Charge Current, ICHG to 246 mA (the range is 8 – 535mA)

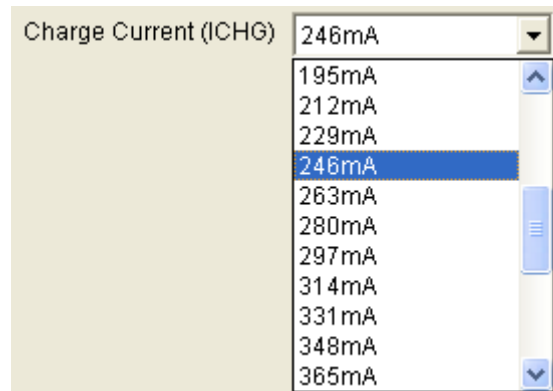

4. Set BATT UVLO threshold to 2.8V (the range is 2.4 – 3.1V)

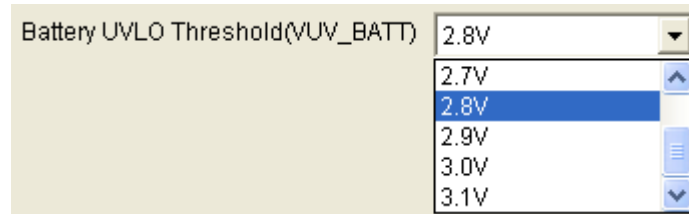

5. Set Trickle Current to 20 mA (the range is 6 – 27mA)

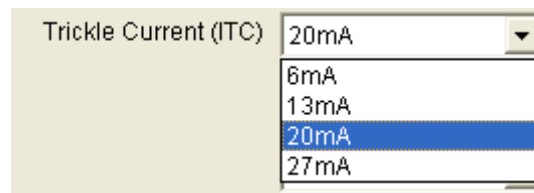

6. Set Charge Full Voltage to 4.200 V (the range is 3.600 - 4.545V)

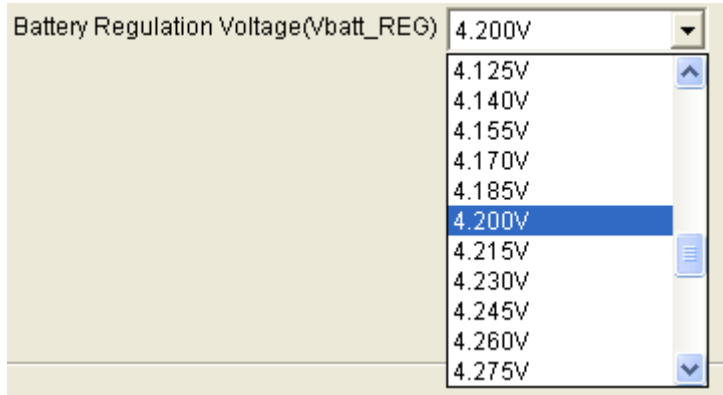

7. Set Trickle - Charge to CC Charge Threshold Voltage to 3.0 V (the range is 2.8 – 3.0V)

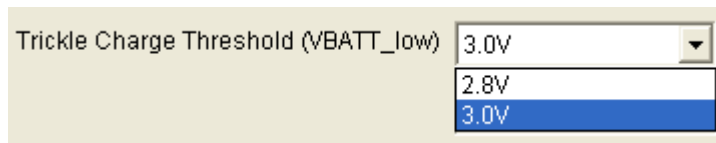

8. Set Battery auto recharge Voltage to VBATT_Full – 300mV (the range is 150mV or 300mV)

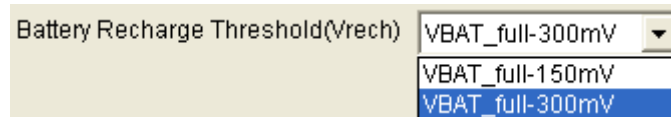

9. Set battery discharge current limit to 1000mA (the range is 100mA to 1600mA):

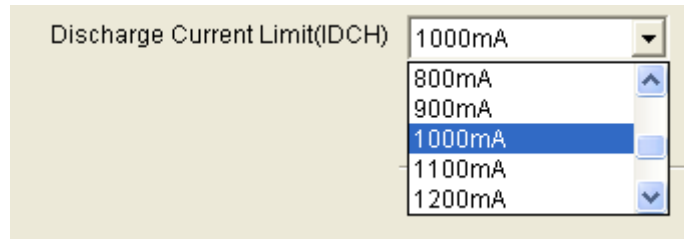

10. Termination Function Select

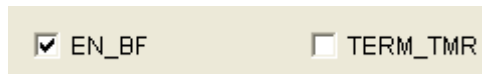
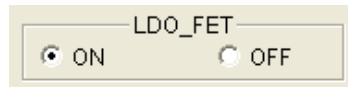

Table 1 Termination Function Selection Table

EN_BF	TERM_TMR	After I _{BATT} hit I _{BF} in CV mode	
		Operation	Charge Status
<input type="checkbox"/>	x	Keep CV Charge	Charge
<input checked="" type="checkbox"/>	<input type="checkbox"/>	Charge Done	Charge Done
<input checked="" type="checkbox"/>	<input checked="" type="checkbox"/>	Keep CV Charge	Charge Done

Others

1. LDO FET Control:



LDO_FET

ON OFF

This bit only controls the on/off of the LDO FET.

2. Battery FET Control:



BATT FET

CHG ON CHG OFF DSG OFF

CHG ON and CHG OFF only control the on/off of the Battery FET in charge mode.

DSG OFF selected could turn off the Battery FET at both charge and discharge mode.

DSG OFF unselected could not turn on Battery FET; pull INT to low by push button could turn on Battery FET when it's turned off by DSG OFF.

3. Other Control.

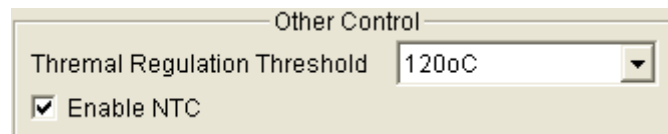

Other Control

Thermal Regulation Threshold 120oC

Enable NTC

4. Safety Timer Setting

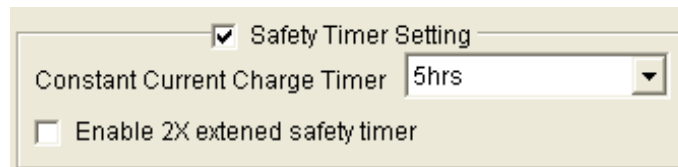

Safety Timer Setting

Constant Current Charge Timer 5hrs

Enable 2X extened safety timer

5. I²C Watchdog Timer



I2C Watchdog Timer

Watchdog Disable Timer

Watchdog AUTO Reset

Watchdog Reset

Rate 04s

6. Resistor Auto Monitor

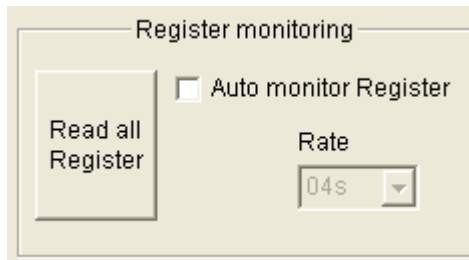

7. Content of the Registers:

Register	7	6	5	4	3	2	1	0
Input Source Control (0X00)	0	1	0	0	0	1	1	1
Power_On Configuration (0X01)	0	0	R	R	0	1	0	0
Charge Current Control (0X02)	R	R	R	0	1	1	1	0
PRE/BF Current (0X03)	R	1	0	0	1	R	1	0
Charge Voltage Control (0X04)	1	0	1	0	0	0	1	1
Timer Control (0X05)	R	1	0	0	1	0	1	0
Miscellaneous Control (0X06)	R	0	0	0	1	0	1	1
System Status(0X07)	0	0	0	0	0	0	0	0
Fault (0X08)	0	0	0	0	0	0	0	0

8. Monitor the MP2660 operation status and Fault report

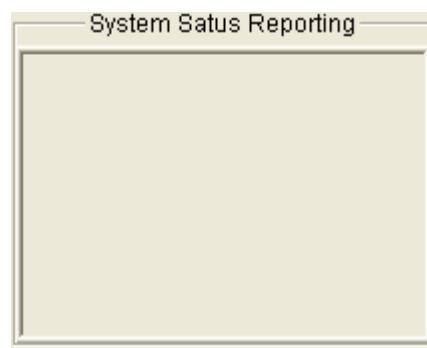
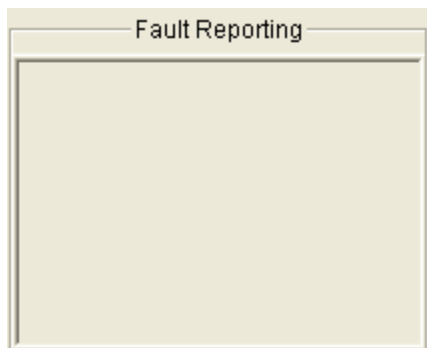



❖Notes❖

1. For the other detailed description on the operation of this part, please contact local FAE to apply the latest datasheet.

NOTICE: The information in this document is subject to change without notice. Users should warrant and guarantee that third party Intellectual Property rights are not infringed upon when integrating MPS products into any application. MPS will not assume any legal responsibility for any said applications.

Looking for pricing, stock, or lifecycle information?

Click below to explore more details on WIN SOURCE:

-  [View EV2660-C-01A on WIN SOURCE](#)
-  [Monolithic Power Systems Inc. Information](#)

Optimize Your Supply Chain with WIN SOURCE Solutions

-  Global Sourcing Solution
-  Obsolete Management
-  Cost Control Management
-  Shortage Management
-  Alternative Solution
-  Excess Inventory Management