



**THE DATASHEET OF
MAAM-011109-TR1000**



Wideband Amplifier

10 MHz - 40 GHz



MAAM-011109

Rev. V3

Features

- 13 dB Gain
- 50 Ω Input / Output Match
- +18 dBm Output Power
- +5 V DC, 190 mA
- Lead-Free 5 mm 9-lead LGA Package
- RoHS* Compliant

Description

The MAAM-011109 is an easy-to-use, wideband amplifier that operates from 10 MHz - 40 GHz. The device features 13 dB gain and +18 dBm of output power. Matching is 50 Ω with typical return loss better than 15 dB. This amplifier requires dual DC supplies: 5 V (190 mA) and a low current -5 V (<1 mA).

The MAAM-011109 integrates an ultra-broadband bias choke, DC blocking and bypass capacitors. Other features include a gate bias adjust pin to change current setting for power or temperature, a gain trim control pin that allows 15 dB of gain control (0 to -1V), and a temperature compensated detector pin that provides a DC voltage in relation to output power.

The MAAM-011109 is ideally suited for any application that requires 50 Ω gain from 10 MHz to 40 GHz. It is useful in applications where the incoming signal varies over a broad bandwidth such as laboratory, instrumentation, and defense applications.

This device is housed in a leadless 5 X 5 X 1.3 mm package that can be handled and placed with standard pick and place assembly equipment. The package base is a two layer laminate with overmold fully compatible with PCB environment and wash conditions. The module includes a GaAs MMIC that is fully passivated for performance and reliability.

Functional Schematic

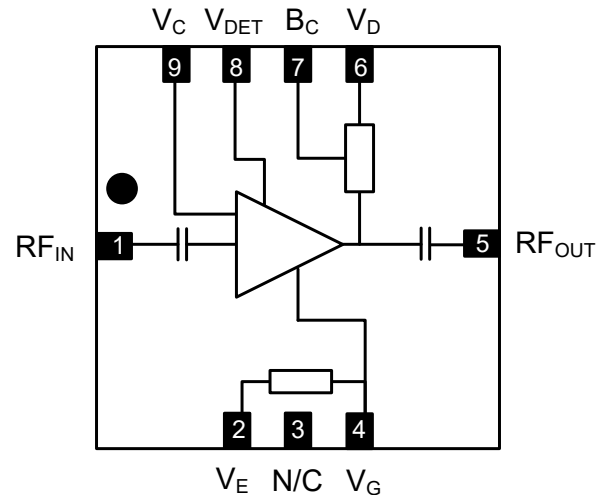

Pin Configuration

Pin #	Pin Name	Function
1	RF _{IN}	RF Input
2	V _E	-5 V Supply
3	N/C	No Connection
4	V _G	Gate Adjust (optional)
5	RF _{OUT}	RF Output
6	V _D	+5 V Supply
7	B _C	V _D Bypass (optional) No Connection
8	V _{DET}	Power Detector
9	V _C	Gain Control
10	Paddle ³	Ground

3. The exposed pad centered on the package bottom must be connected to RF and DC ground.

Ordering Information^{1,2}

Part Number	Package
MAAM-011109	bulk quantity
MAAM-011109-TR0100	100 piece reel
MAAM-011109-TR1000	1000 piece reel
MAAM-011109-001SMB	Sample board

1. Reference Application Note M513 for reel size information.
2. All sample boards include 3 loose parts.

* Restrictions on Hazardous Substances, compliant to current RoHS EU directive.

Electrical Specifications: $T_A = +25^\circ\text{C}$, $V_D = +5\text{ V}$, $V_E = -5\text{ V}$, $V_C = \text{Open}$, $Z_{IN} = Z_{OUT} = 50\ \Omega$

Parameter	Test Conditions	Units	Min.	Typ.	Max.
Gain	0.1 GHz	dB	—	12.0	—
	2 GHz		11.0	13.0	
	12 GHz		10.0	12.0	
	20 GHz		10.0	11.5	
	32 GHz		8.0	11.0	
	40 GHz		—	8.0	
Isolation	0.01 - 40 GHz	dB	—	22	—
Input Return Loss	0.01 - 40 GHz	dB	—	13	—
Output Return Loss	0.01 - 40 GHz	dB	—	9	—
Noise Figure	0.01 - 40 GHz	dB	—	3.5	—
P1dB	0.1 GHz	dBm	—	+18	—
	10 GHz			+17	
	40 GHz			+13	
Output IP3	0.1 GHz	dBm	—	+26	—
	10 GHz			+24	
	40 GHz			+16	
Bias Current	$V_D = +5\text{ V}$, $V_E = -5\text{ V}$	mA	—	170	—

Absolute Maximum Ratings^{4,5,6}

Parameter	Absolute Max.
Input Power	+17 dBm
Drain Supply Voltage	+8 Volts
Junction Temperature ⁷	+150°C
Operating Temperature	-40°C to +85°C
Storage Temperature	-65°C to +150°C

- Exceeding any one or combination of these limits may cause permanent damage to this device.
- MACOM does not recommend sustained operation near these survivability limits.
- Operating at nominal conditions with $T_J \leq 150^\circ\text{C}$ will ensure $\text{MTTF} > 1 \times 10^6$ hours.
- Junction Temperature (T_J) = $T_C + \Theta_{JC} * ((V * I) - (P_{OUT} - P_{IN}))$
 Typical thermal resistance (Θ_{JC}) = 21°C/W
 - For $T_C = 25^\circ\text{C}$,
 $T_J = 43^\circ\text{C}$ @ 5 V, 190 mA, $P_{OUT} = 20\text{ dBm}$, $P_{IN} = 7\text{ dBm}$
 - For $T_C = 85^\circ\text{C}$,
 $T_J = 103^\circ\text{C}$ @ 5 V, 190 mA, $P_{OUT} = 20\text{ dBm}$, $P_{IN} = 7\text{ dBm}$

Handling Procedures

Please observe the following precautions to avoid damage:

Static Sensitivity

These electronic devices are sensitive to electrostatic discharge (ESD) and can be damaged by static electricity. Proper ESD control techniques should be used when handling these Class 1B devices.

Application Schematic

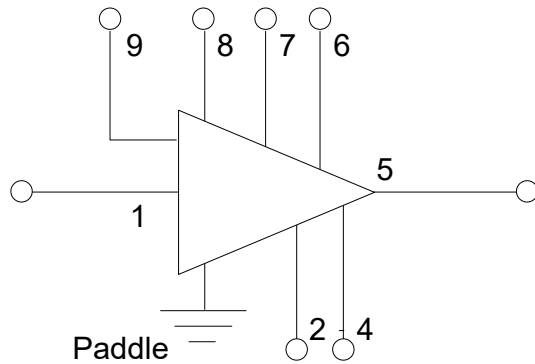

Recommended PCB Layout

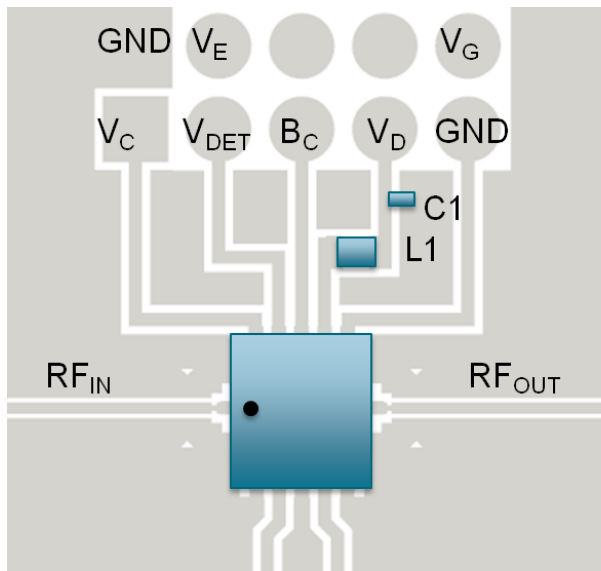

Parts List

Component	Value	Package
C1	0.22 μ F	0201
L1	470 Ω	0603

Application Information for DC & pins

For proper MAAM-011109 operation a DC voltage must be applied at the V_E (-5 V) and V_D (+5 V) pins *in that order*. The optional V_G pin maybe used to override the automatic V_E bias network to hard set the gate. Adjusting V_G from -0.2 V to -0.6 V will change the quiescent current. If V_G is used, V_E should be left unconnected.

The V_C pin is typically left unconnected unless gain control or output power limiting is desired. Please refer to the “Variable Gain/Limiting” section for detailed usage.

The V_D pin should be bypassed with at least 0.1 μ F for stability. For operation below 100 MHz a ferrite bead (Murata BLM18BB471) must be inserted between the V_D pin and bypass capacitor. The V_G and V_C pins must also be bypassed with a 0.1 μ F capacitor if operating below 100 MHz.

The V_{DET} pin is typically left unconnected unless a voltage reference is desired that is correlated to the output power. Please refer to the “Internal Detector” section for detailed usage.

The B_C pin is typically left unconnected unless gain bandwidth and shape change is desired. Please refer to an application note on this pin.

The input and output pins are internally DC blocked. No more than +/- 12 V should ever be present on these RF only pins.

The backside paddle of the MAAM-011109 should be connected to ground with as many vias as possible to maximize high frequency performance, thermal dissipation, and stability.

Typical Performance Curves over Temperature

Gain

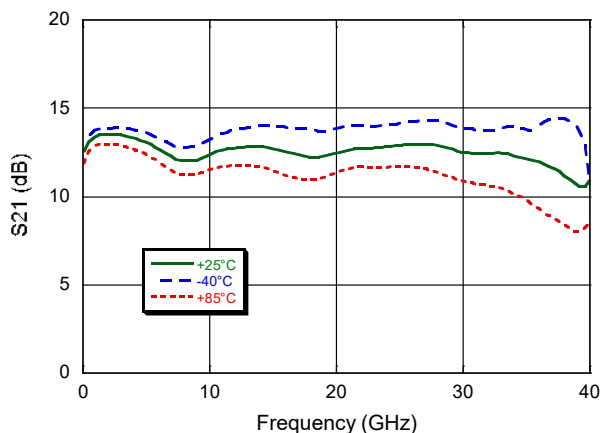

Noise Figure

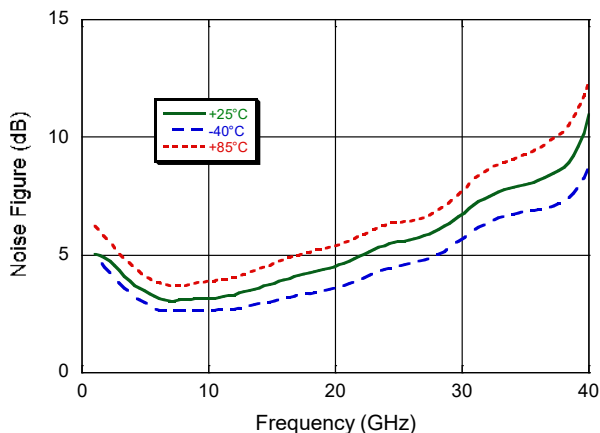

Input Return Loss

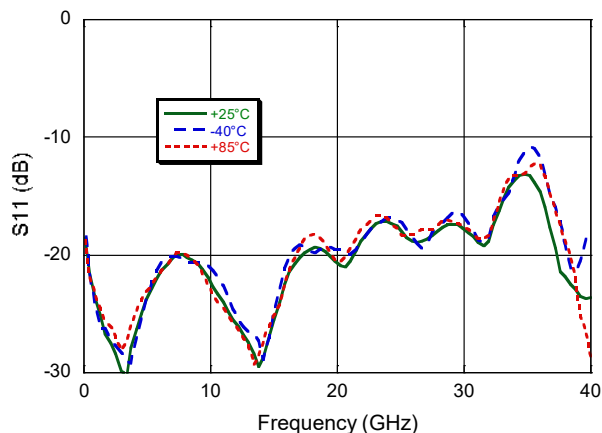

Output Return Loss

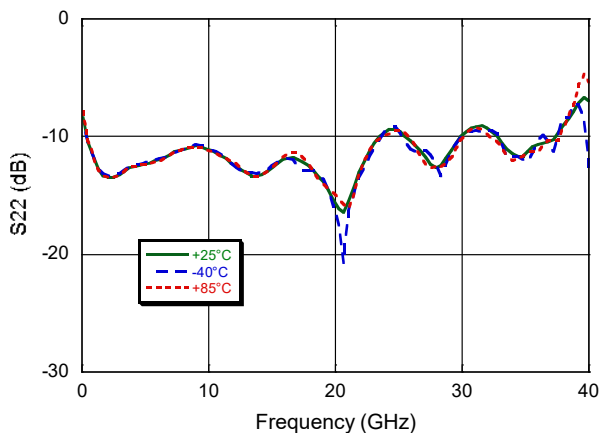

Output P1dB

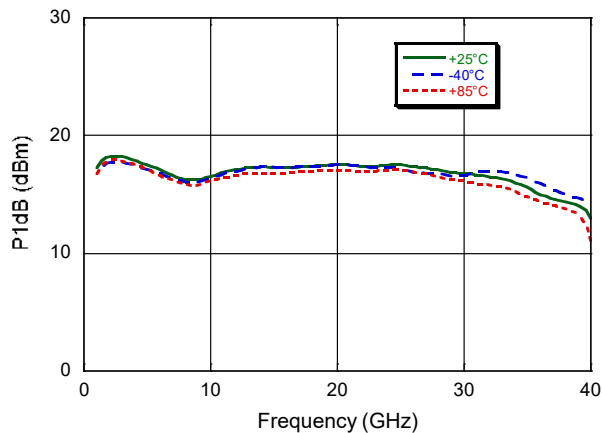

Output IP3

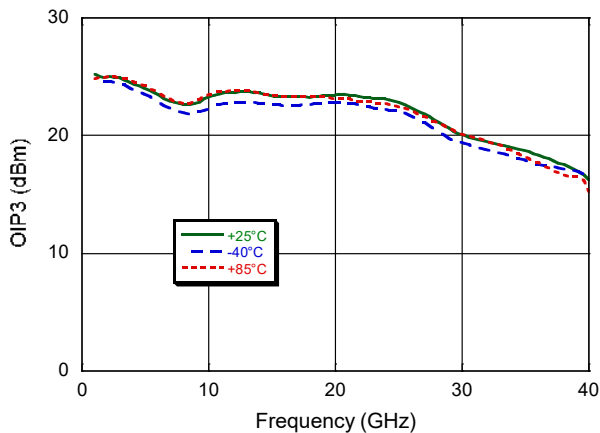

Typical Performance Curves vs. Voltage and Current

Gain

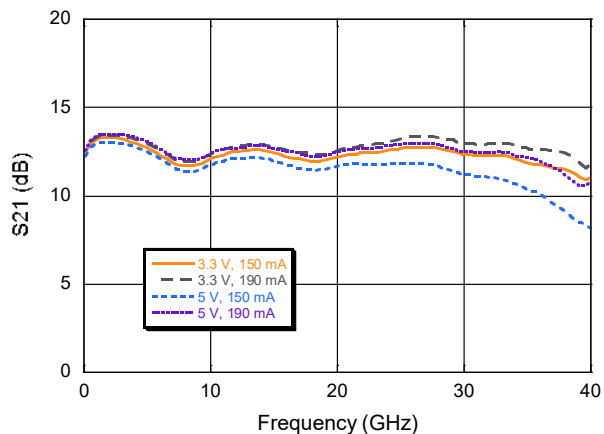

Noise Figure

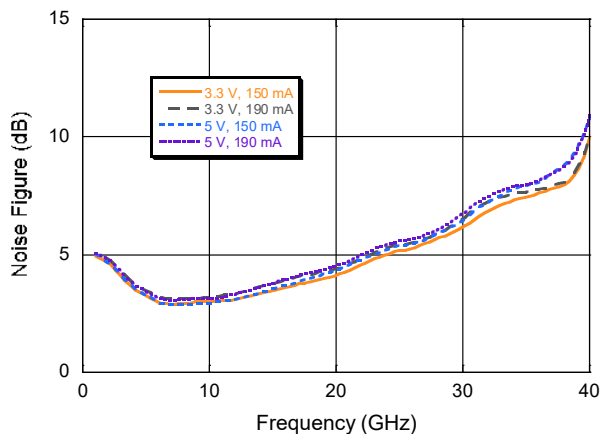

Input Return Loss

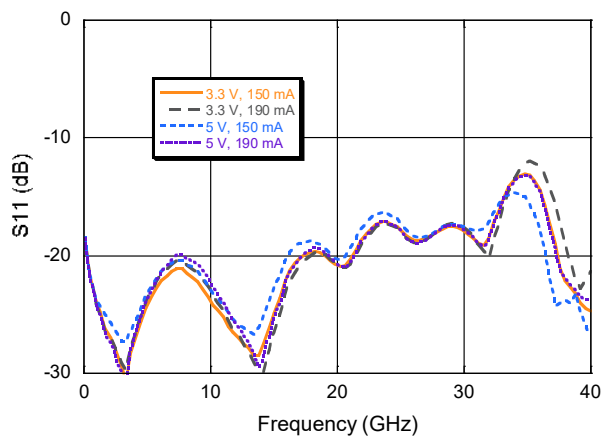

Output Return Loss

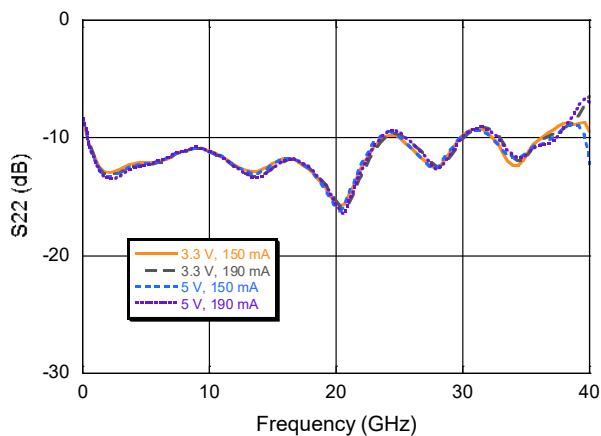

Output P1dB

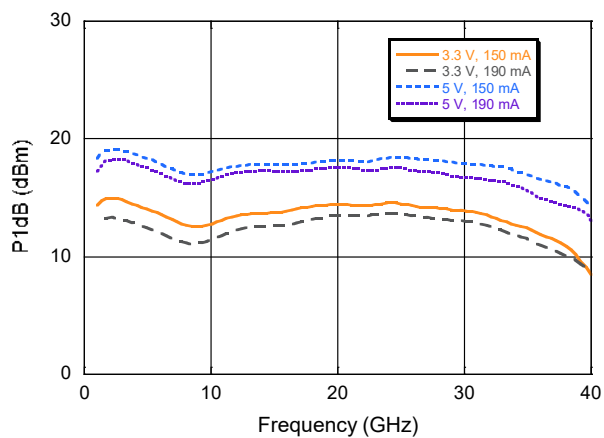

Output IP3

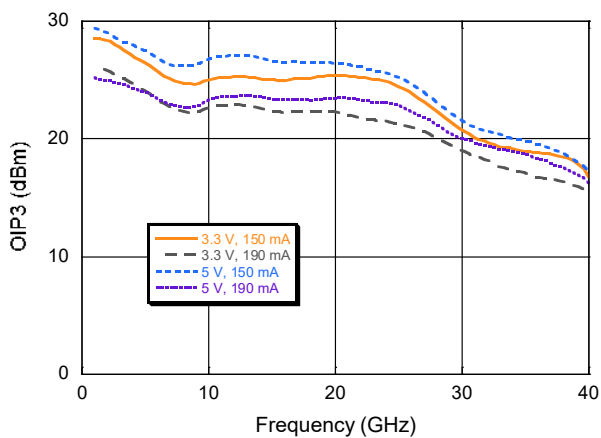

Typical Performance Curves

Isolation

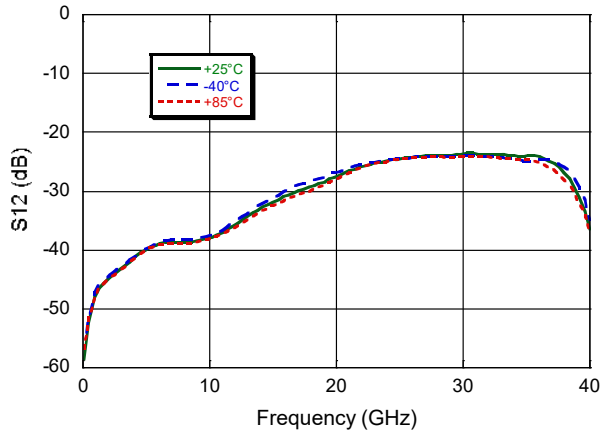

Gain vs. Frequency, $V_c = -0.9$ to 1.1 V

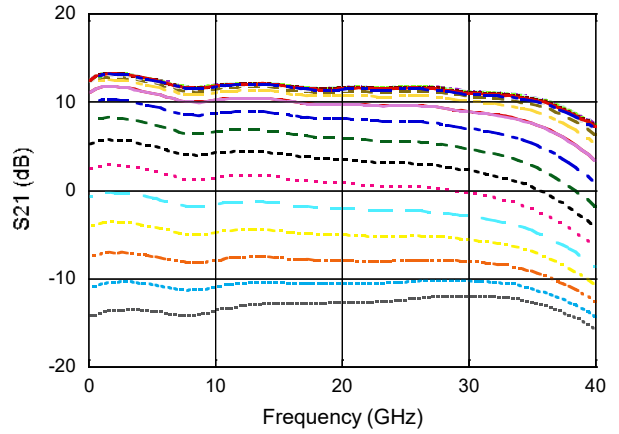

Stability Factor

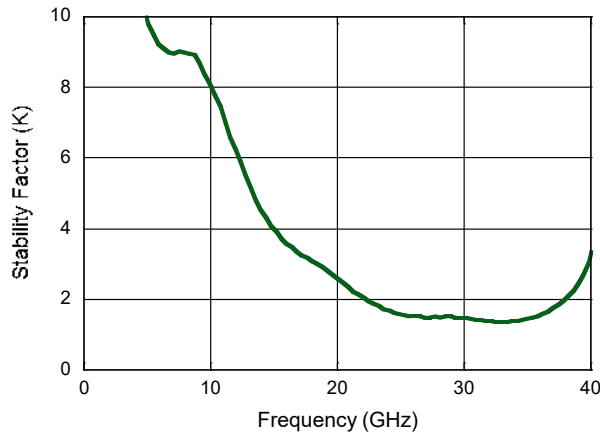

Output Saturated Power

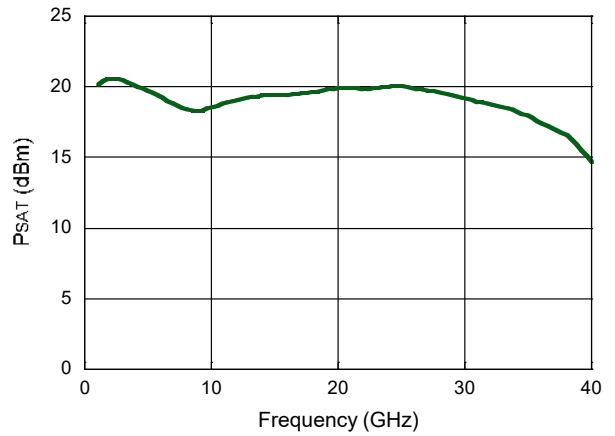

Gain @ 5 GHz vs. Control Voltage

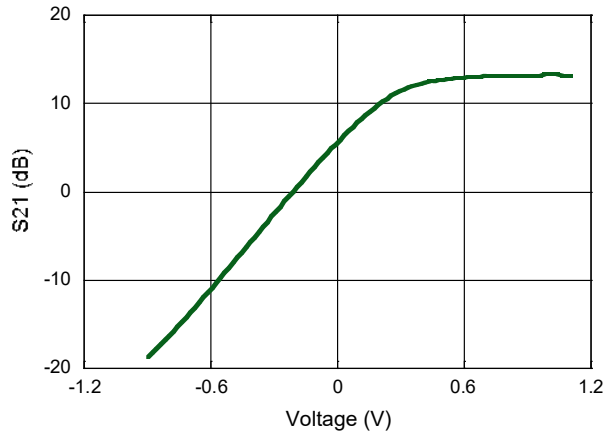

Low Frequency Response

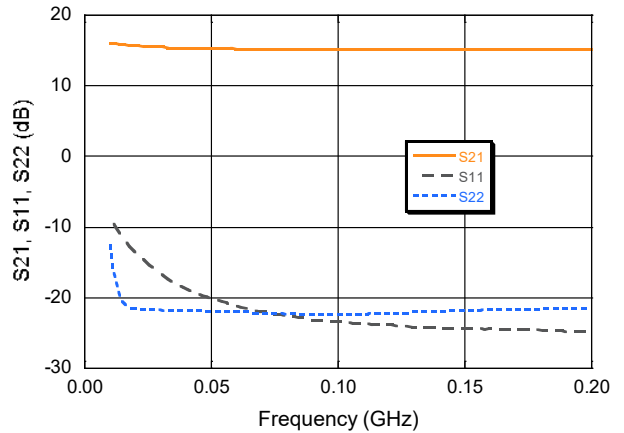

Typical Performance Curves

V_{DET} vs. Output Power

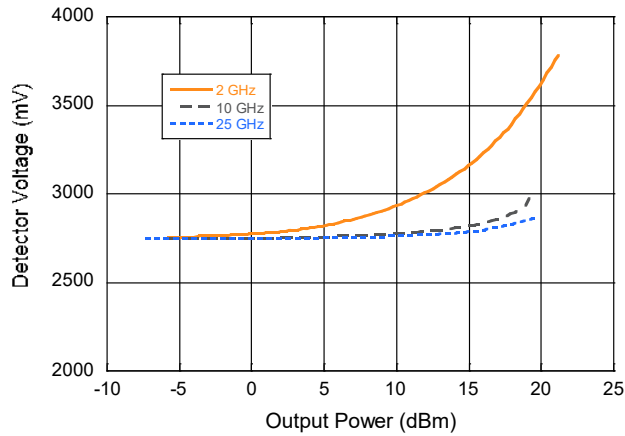

V_{DET} vs. Output Power @ 2 GHz

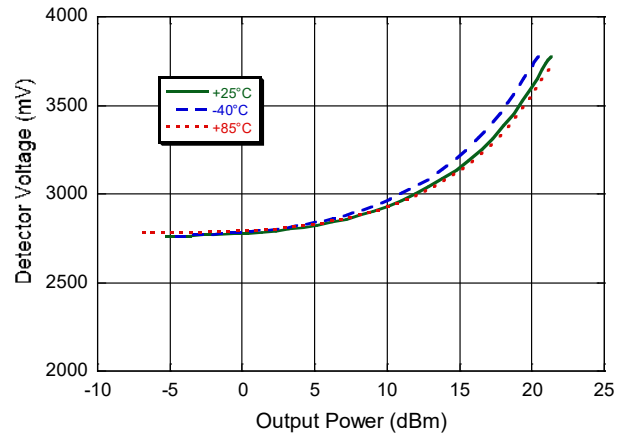

Current vs. Gate Voltage

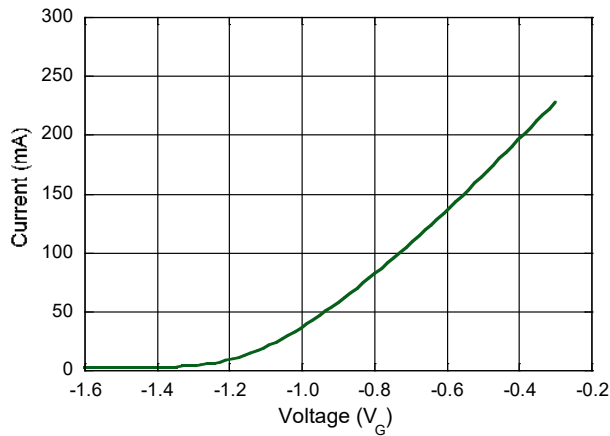

Current vs. Control Voltage

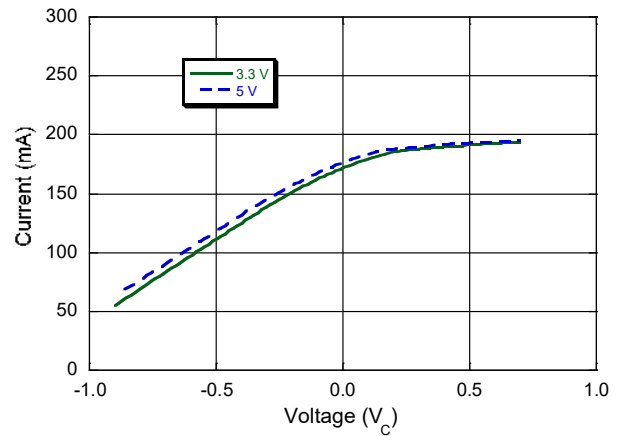

Application Details

Bandwidth, Power, Noise and Linearity

V_D and I_D affect both the bandwidth (response flatness), power available, noise figure, and linearity of the amplifier. Higher currents and lower V_D increase high frequency gain but reduce the P1dB and the OIP3 numbers. If the device is driven to P1dB and on into P_{SAT} the current, I_D , will naturally reduce. The device will return to the quiescent I_D value once the input power is reduced. Finally, higher I_D and V_D values increase the device noise figure. Temperature also affects the bandwidth, gain and noise figure of the device. Lower temperatures increase gain and bandwidth and reduce the noise figure. Temperature has little effect on power and linearity.

Broadband Amplifier Applications

The MAAM-011109 also has a low enough noise figure to be used in instrumentation front ends and buffer applications. It also has very flat response with low group delay distortion so it can be used in pulse applications. For higher gains multiple amplifiers may be cascaded. It also makes a very good low cost optical driver capable of delivering to 8 V p-p into 50 Ω .

Variable Gain/Limiting Applications

The gain of the MAAM-011109 can be easily controlled with the V_C pin. The gain reduction is almost linear with V_C between 0.1 V to -0.8 V. Below -0.7 V internal ESD protection diodes will draw increasing current (50 mA at -1.0 V). The V_C pin should not be driven below -1 V or above 1.2 V. The nominal open circuit voltage at the V_C pin is 0.8 V. Reducing V_C below 0.8 V will also reduce I_D . Gain, P1dB, and P_{SAT} will all be reduced as V_C is lowered. Limiting applications and zero crossing adjustment can be done by adjusting the V_G and V_C pins together.

Internal Detector

The V_{DET} pin is connected to an internal diode detector. This pin should be connected to a high impedance (>50 k Ω) or left unconnected. The detector is internally connected so that it responds predominately to the power generated by the amplifier. The detector has a low pass characteristic which rolls off gradually above 2 GHz. The detector is temperature compensated. Finally, even with zero output power the detector has a DC output voltage proportional to V_D (nominally 2.8 V for $V_D = 5$ V).

Lead-Free 5 mm 9-lead LGA

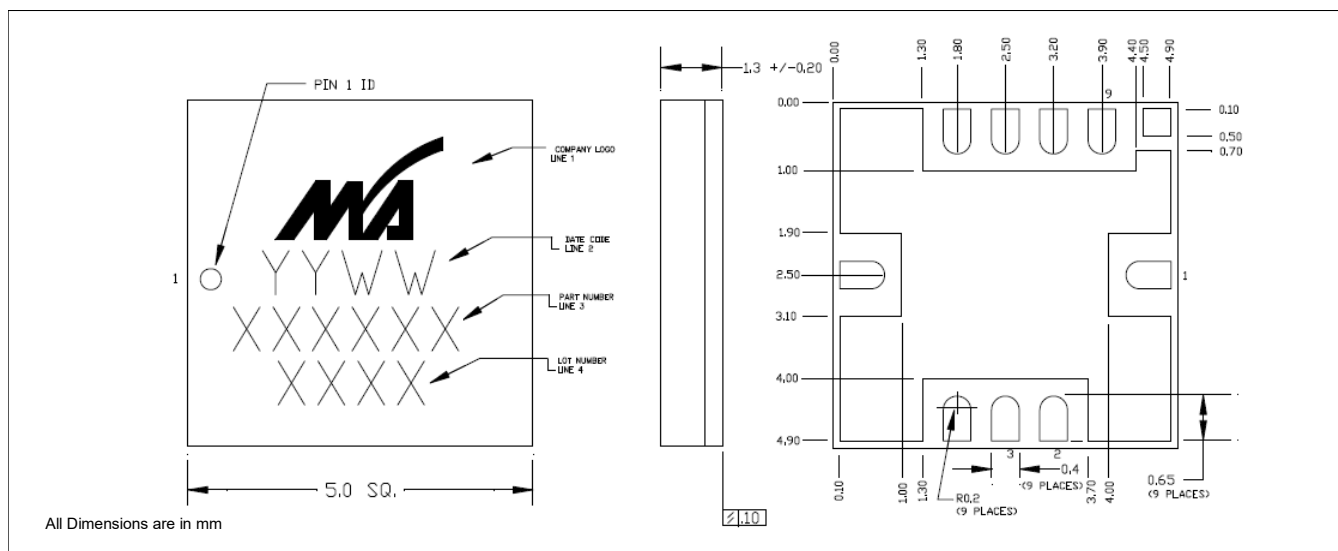

† Reference Application Note S2083 for lead-free solder reflow recommendations.
Meets JEDEC moisture sensitivity level 3 requirements.
Plating is gold over nickel.

MACOM Technology Solutions Inc. ("MACOM"). All rights reserved.

These materials are provided in connection with MACOM's products as a service to its customers and may be used for informational purposes only. Except as provided in its Terms and Conditions of Sale or any separate agreement, MACOM assumes no liability or responsibility whatsoever, including for (i) errors or omissions in these materials; (ii) failure to update these materials; or (iii) conflicts or incompatibilities arising from future changes to specifications and product descriptions, which MACOM may make at any time, without notice. These materials grant no license, express or implied, to any intellectual property rights.

THESE MATERIALS ARE PROVIDED "AS IS" WITH NO WARRANTY OR LIABILITY, EXPRESS OR IMPLIED, RELATING TO SALE AND/OR USE OF MACOM PRODUCTS INCLUDING FITNESS FOR A PARTICULAR PURPOSE, MERCHANTABILITY, INFRINGEMENT OF INTELLECTUAL PROPERTY RIGHT, ACCURACY OR COMPLETENESS, OR SPECIAL, INDIRECT, INCIDENTAL, OR CONSEQUENTIAL DAMAGES WHICH MAY RESULT FROM USE OF THESE MATERIALS.

MACOM products are not intended for use in medical, lifesaving or life sustaining applications. MACOM customers using or selling MACOM products for use in such applications do so at their own risk and agree to fully indemnify MACOM for any damages resulting from such improper use or sale.

Looking for pricing, stock, or lifecycle information?

Click below to explore more details on WIN SOURCE:

- ⊖ [View MAAM-011109-TR1000 on WIN SOURCE](#)
- ⊖ [M/A-Com Technology Solutions Information](#)

Optimize Your Supply Chain with WIN SOURCE Solutions

- ✓ Global Sourcing Solution
- ✓ Obsolete Management
- ✓ Cost Control Management
- ✓ Shortage Management
- ✓ Alternative Solution
- ✓ Excess Inventory Management