

DATA SHEET

SURFACE-MOUNT CERAMIC MULTILAYER CAPACITORS

General purpose & High capacitance

Class 2, Y5V

6.3 V TO 50 V

10 nF to 47 μ F

RoHS compliant & Halogen Free



SCOPE

This specification describes Y5V series chip capacitors with lead-free terminations.

APPLICATIONS

Consumer electronics, for example:

- Tuners
- Television receivers
- Video recorders
- All types of cameras
- Mobile telephones

FEATURES

Supplied in tape on reel
 Nickel-barrier end termination
 RoHS compliant
 Halogen Free compliant

ORDERING INFORMATION - GLOBAL PART NUMBER, PHYCOMP

CTC & I2NC

All part numbers are identified by the series, size, tolerance, TC material, packing style, voltage, process code, termination and capacitance value.

YAGEO BRAND ordering code

GLOBAL PART NUMBER (PREFERRED)

CC XXXX X X **Y5V** X **BB** XXX
 (1) (2) (3) (4) (5)

(1) SIZE – INCH BASED (METRIC)

- 0201 (0603)
- 0402 (1005)
- 0603 (1608)
- 0805 (2012)
- 1206 (3216)
- 1210 (3225)

(2) TOLERANCE

- M = ±20%
- Z = -20% to +80%

(3) PACKING STYLE

- R = Paper/PE taping reel; Reel 7 inch
- K = Blister taping reel; Reel 7 inch
- P = Paper/PE taping reel; Reel 13 inch
- F = Blister taping reel; Reel 13 inch

(4) RATED VOLTAGE

- 5 = 6.3 V
- 6 = 10 V
- 7 = 16 V
- 8 = 25 V
- 9 = 50 V

(5) CAPACITANCE VALUE

2 significant digits+number of zeros
 The 3rd digit signifies the multiplying factor, and letter R is decimal point
 Example: 103 = 10 × 10³ = 10,000 pF = 10 nF

CONSTRUCTION

The capacitor consists of a rectangular block of ceramic dielectric in which a number of interleaved metal electrodes are contained. This structure gives rise to a high capacitance per unit volume.

The inner electrodes are connected to the two end terminations and finally covered with a layer of plated tin (NiSn). The terminations are lead-free. A cross section of the structure is shown in Fig.1.

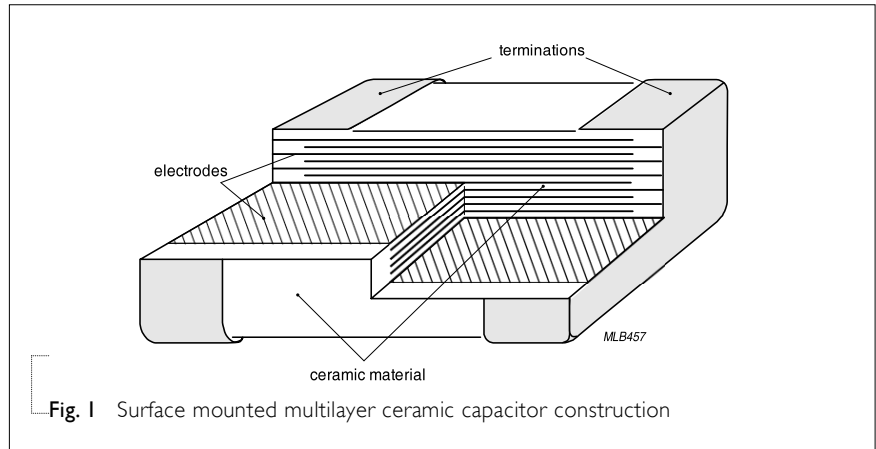

DIMENSION

Table I For outlines see fig. 2

TYPE	L ₁ (mm)	W (mm)	T (MM)	L ₂ / L ₃ (mm)		L ₄ (mm)
				min.	max.	min.
0201	0.6 ±0.03	0.3 ±0.03	Refer to table 2 to 4	0.10	0.20	0.20
0402	1.0 ±0.05	0.5 ±0.05		0.20	0.30	0.40
0603	1.6 ±0.10	0.8 ±0.10		0.20	0.60	0.40
0805	2.0 ±0.10 ⁽¹⁾	1.25 ±0.10 ⁽¹⁾		0.25	0.75	0.70
	2.0 ±0.20 ⁽²⁾	1.25 ±0.20 ⁽²⁾				
1206	3.2 ±0.15 ⁽¹⁾	1.6 ±0.15 ⁽¹⁾		0.25	0.75	1.40
	3.2 ±0.30 ⁽²⁾	1.6 ±0.20 ⁽²⁾				
1210	3.2 ±0.20 ⁽¹⁾	2.5 ±0.20 ⁽¹⁾		0.25	0.75	1.40
	3.2 ±0.40 ⁽²⁾	2.5 ±0.30 ⁽²⁾				
1812	4.5 ±0.20 ⁽¹⁾	3.2 ±0.20 ⁽¹⁾		0.25	0.75	2.20
	4.5 ±0.40 ⁽²⁾	3.2 ±0.40 ⁽²⁾				

NOTE

1. Dimension for size 0805 to 1812, C ≤ 100 nF
2. Dimension for size 0805 to 1812, C > 100 nF

OUTLINES

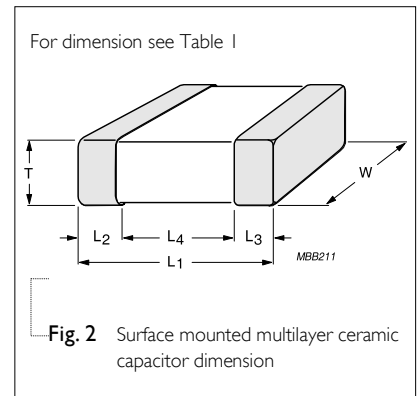

CAPACITANCE RANGE & THICKNESS FOR Y5V
Table 2 Sizes from 0201 to 0402

CAP.	0201		0402				
	6.3 V	25 V	6.3 V	10 V	16 V	25 V	50 V
10 nF		0.3±0.03		0.5±0.05	0.5±0.05	0.5±0.05	0.5±0.05
22 nF				0.5±0.05	0.5±0.05	0.5±0.05	
47 nF				0.5±0.05	0.5±0.05	0.5±0.05	
100 nF	0.3±0.03		0.5±0.05	0.5±0.05	0.5±0.05	0.5±0.05	
220 nF			0.5±0.05	0.5±0.05	0.5±0.05		
470 nF			0.5±0.05	0.5±0.05	0.5±0.05		
1.0 µF			0.5±0.05	0.5±0.05			
2.2 µF							
4.7 µF							
10 µF							
22 µF							
47 µF							

Table 3 Sizes from 0603 to 0805

CAP.	0603					0805				
	6.3 V	10 V	16 V	25 V	50 V	6.3 V	10 V	16 V	25 V	50 V
10 nF				0.8±0.1	0.8±0.1				0.6±0.1	0.6±0.1
22 nF				0.8±0.1	0.8±0.1				0.6±0.1	0.6±0.1
47 nF				0.8±0.1	0.8±0.1				0.6±0.1	0.6±0.1
100 nF			0.8±0.1	0.8±0.1	0.8±0.1				0.6±0.1	0.6±0.1
220 nF			0.8±0.1	0.8±0.1				0.6±0.1	0.85±0.1	0.85±0.1
470 nF			0.8±0.1	0.8±0.1				0.85±0.1	0.85±0.1	0.85±0.1
1.0 µF	0.8±0.1	0.8±0.1	0.8±0.1					0.85±0.1	0.85±0.1	1.25±0.2
2.2 µF	0.8±0.1	0.8±0.1	0.8±0.1			0.85±0.1	0.85±0.1	0.85±0.1	1.25±0.2	
4.7 µF	0.8±0.1					0.85±0.1	0.85±0.1	1.25±0.2		
10 µF						1.25±0.2	1.25±0.2			
22 µF						1.25±0.2	1.25±0.2			
47 µF										

NOTE

1. Values in shaded cells indicate thickness class in mm
2. Capacitance value of non E-3 series is on request

CAPACITANCE RANGE & THICKNESS FOR Y5V

Table 4 Sizes from 1206 to 1210

CAP.	1206					1210				
	6.3 V	10 V	16 V	25 V	50 V	6.3 V	10 V	16 V	25 V	50V
10 nF				0.6±0.1	0.6±0.1					
22 nF				0.6±0.1	0.6±0.1					
47 nF				0.6±0.1	0.6±0.1					
100 nF				0.6±0.1	0.6±0.1					
220 nF				0.6±0.1	0.6±0.1					
470 nF				0.85±0.1	0.85±0.1					
1.0 µF				0.85±0.1						
2.2 µF		0.85±0.1	0.85±0.1	0.85±0.1						
4.7 µF		0.85±0.1	0.85±0.1							
10 µF	0.85±0.1	0.85±0.1	1.15±0.1	1.6±0.2		1.5±0.1	1.5±0.1	1.5±0.1	1.5±0.1	1.5±0.1
22 µF	1.6±0.2	1.6±0.2	1.6±0.2			1.6±0.2	1.6±0.2	1.6±0.2		
47 µF										

NOTE

1. Values in shaded cells indicate thickness class in mm
2. Capacitance value of non E-3 series is on request

THICKNESS CLASSES AND PACKING QUANTITY

Table 5

SIZE CODE	THICKNESS CLASSIFICATION	TAPE WIDTH QUANTITY PER REEL	Ø180 MM / 7 INCH		Ø330 MM / 13 INCH		QUANTITY PER BULK CASE
			Paper	Blister	Paper	Blister	
0201	0.3 ±0.03 mm	8 mm	15,000	---	50,000	---	---
0402	0.5 ±0.05 mm	8 mm	10,000	---	50,000	---	50,000
0603	0.8 ±0.1 mm	8 mm	4,000	---	15,000	---	15,000
0805	0.6 ±0.1 mm	8 mm	4,000	---	20,000	---	10,000
	0.85 ±0.1 mm	8 mm	4,000	---	15,000	---	8,000
	1.25 ±0.2 mm	8 mm	---	3,000	---	10,000	5,000
1206	0.6 ±0.1 mm	8 mm	4,000	---	20,000	---	---
	0.85 ±0.1 mm	8 mm	4,000	---	15,000	---	---
	1.00 / 1.15 ±0.1 mm	8 mm	---	3,000	---	10,000	---
	1.25 ±0.2 mm	8 mm	---	3,000	---	10,000	---
	1.6 ±0.15 mm	8 mm	---	2,500	---	10,000	---
1210	1.6 ±0.2 mm	8 mm	---	2,000	---	10,000	---
	0.6 / 0.7 ±0.1 mm	8 mm	---	4,000	---	15,000	---
	0.85 ±0.1 mm	8 mm	---	4,000	---	10,000	---
	1.15 ±0.1 mm	8 mm	---	3,000	---	10,000	---
	1.15 ±0.15 mm	8 mm	---	3,000	---	10,000	---
	1.25 ±0.2 mm	8 mm	---	3,000	---	---	---
	1.5 ±0.1 mm	8 mm	---	2,000	---	---	---
	1.6 / 1.9 ±0.2 mm	8 mm	---	2,000	---	---	---
2.0 ±0.2 mm	8 mm	---	2,000	---	---	---	---
	8 mm	---	1,000	---	---	---	---
2.5 ±0.2 mm	8 mm	---	1,000	---	---	---	---
	8 mm	---	500	---	---	---	---

ELECTRICAL CHARACTERISTICS

Y5V DIELECTRIC CAPACITORS; NISN TERMINATIONS

Unless otherwise specified, all test and measurements shall be made under standard atmospheric conditions for testing as given in 5.3 of IEC 60068-1:

- Temperature: 15 °C to 35 °C
- Relative humidity: 25% to 75%
- Air pressure: 86 kPa to 106 kPa

Before the measurements are made, the capacitor shall be stored at the measuring temperature for a time sufficient to allow the entire capacitor to reach this temperature.

The period as prescribed for recovery at the end of a test is normally sufficient for this purpose.

Table 6

DESCRIPTION	VALUE
Capacitance range	10 nF to 22 µF
Capacitance tolerance	±20% -20% to +80%
Dissipation factor (D.F.)	
≤ 6.3 V	≤ 15%
Exception: 0805 ≥ 22 µF	≤ 20%
10 V	≤ 12.5%
Exception: 0402 ≥ 680 nF; 0603 ≥ 2.2 µF;	≤ 15%
0805 ≥ 10 µF; 1206 ≥ 10 µF	≤ 20%
16 V	≤ 12.5%
Exception: 0603 ≥ 4.7 µF	≤ 15%
≥ 25 V	≤ 9%
Exception: 0201 ≥ 10 nF	≤ 12.5%
Insulation resistance after 1 minute at U_r (DC)	$R_{ins} \geq 10 \text{ G}\Omega$ or $R_{ins} \times C_r \geq 500$ seconds whichever is less
Maximum capacitance change as a function of temperature (temperature characteristic/coefficient):	+22% to -82%
Operating temperature range:	-30 °C to +85 °C

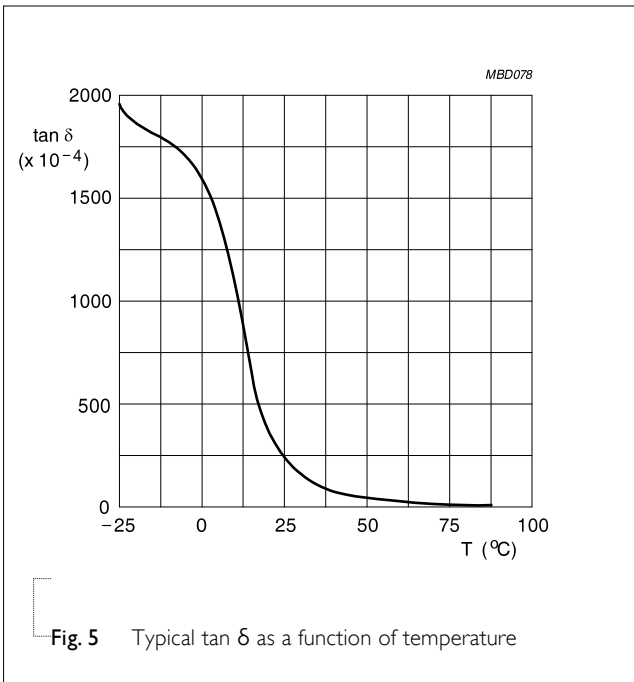
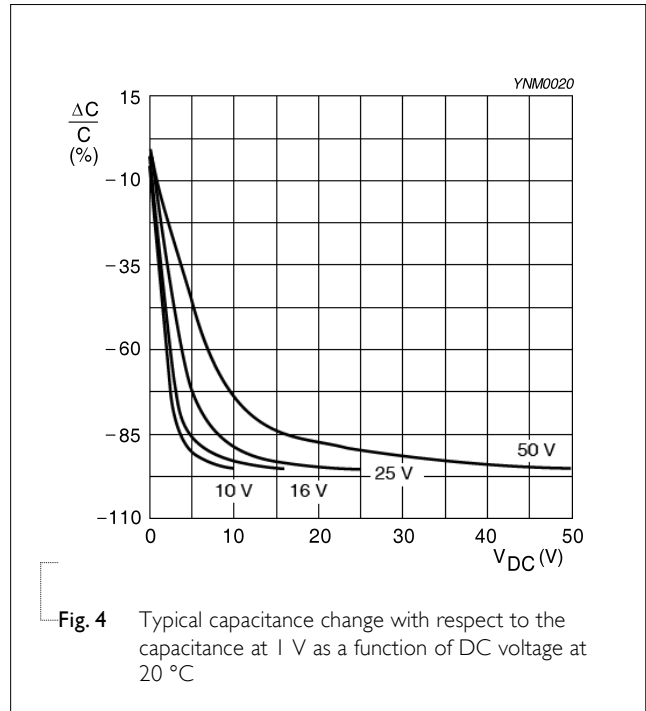
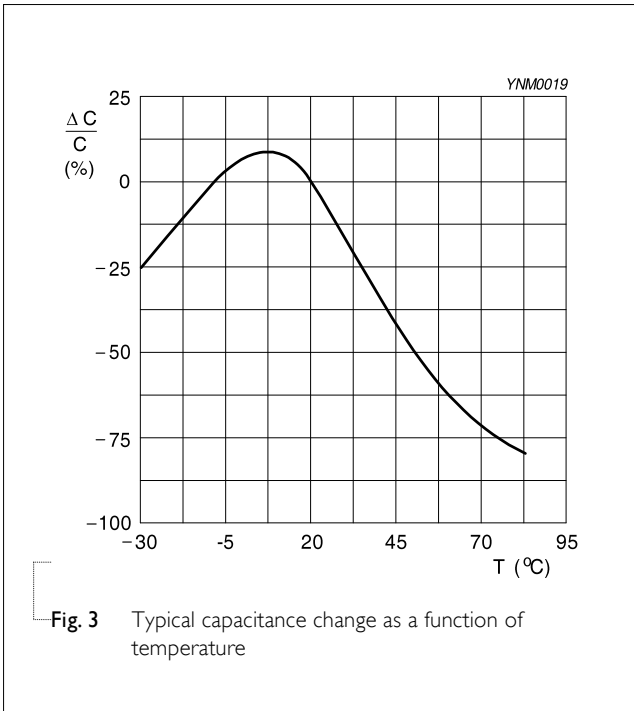

SOLDERING RECOMMENDATION

Table 7

SOLDERING METHOD	SIZE					
	0201	0402	0603	0805	1206	≥ 1210
Reflow	Reflow only	> 100 nF	> 1.0 μF	> 2.2 μF	> 2.2 μF	Reflow only
Reflow/Wave		≤ 100 nF	≤ 1.0 μF	≤ 2.2 μF	≤ 2.2 μF	---

TESTS AND REQUIREMENTS

Table 8 Test procedures and requirements

TEST	TEST METHOD	PROCEDURE	REQUIREMENTS
Mounting	IEC 60384-21/22 4.3	The capacitors may be mounted on printed-circuit boards or ceramic substrates	No visible damage
Visual inspection and dimension check	4.4	Any applicable method using × 10 magnification	In accordance with specification
Capacitance ⁽¹⁾	4.5.1	Class 2: At 20 °C, 24 hrs after annealing f = 1 KHz for C ≤ 10 μF, rated voltage > 6.3 V, measuring at voltage 1 V _{rms} at 20 °C f = 1 KHz, for C ≤ 10 μF, rated voltage ≤ 6.3 V, measuring at voltage 0.5 V _{rms} at 20 °C f = 120 Hz for C > 10 μF, measuring at voltage 0.5 V _{rms} at 20 °C	Within specified tolerance
Dissipation factor (D.F.) ⁽¹⁾	4.5.2	Class 2: At 20 °C, 24 hrs after annealing f = 1 KHz for C ≤ 10 μF, rated voltage > 6.3 V, measuring at voltage 1 V _{rms} at 20 °C f = 1 KHz, for C ≤ 10 μF, rated voltage ≤ 6.3 V, measuring at voltage 0.5 V _{rms} at 20 °C f = 120 Hz for C > 10 μF, measuring at voltage 0.5 V _{rms} at 20 °C	In accordance with specification
Insulation resistance	4.5.3	At U _r (DC) for 1 minute	In accordance with specification
Temperature characteristic	4.6	Class 2: Between minimum and maximum temperature Y5V: -30 °C to +85 °C Normal Temperature: 20 °C	<General purpose series> ΔC/C Class 2: Y5V: 22% to -82% <High Capacitance series> ΔC/C Class 2: Y5V: 22% to -82%
Adhesion	4.7	A force applied for 10 seconds to the line joining the terminations and in a plane parallel to the substrate	Force size ≥ 0603: 5N size = 0402: 2.5N size = 0201: 1N

NOTE:

1. For individual product specification, please contact local sales.

TEST	TEST METHOD	PROCEDURE	REQUIREMENTS
Bending strength	IEC 60384-21/22	4.8 Mounting in accordance with IEC 60384-22 paragraph 4.3	No visible damage
		Conditions: bending 1 mm at a rate of 1 mm/s, radius jig 5 mm	<p><General purpose series></p> <p>$\Delta C/C$</p> <p>Class2:</p> <p>Y5V: $\pm 10\%$</p> <p><High Capacitance series></p> <p>$\Delta C/C$</p> <p>Class2:</p> <p>Y5V: $\pm 10\%$</p>
Resistance to soldering heat	4.9	Precondition: 150 ± 10 °C for 1 hour, then keep for 24 ± 1 hours at room temperature	Dissolution of the end face plating shall not exceed 25% of the length of the edge concerned
		Preheating: for size ≤ 1206 : 120 °C to 150 °C for 1 minute Preheating: for size > 1206 : 100 °C to 120 °C for 1 minute and 170 °C to 200 °C for 1 minute Solder bath temperature: 260 ± 5 °C Dipping time: 10 ± 0.5 seconds Recovery time: 24 ± 2 hours	
			<p><General purpose series></p> <p>$\Delta C/C$</p> <p>Class2:</p> <p>Y5V: $\pm 20\%$</p> <p><High Capacitance series></p> <p>$\Delta C/C$</p> <p>Class2:</p> <p>Y5V: $\pm 20\%$</p>
			<p>D.F. within initial specified value</p> <p>R_{ins} within initial specified value</p>
Solderability	4.10	Preheated the temperature of 80 °C to 140 °C and maintained for 30 seconds to 60 seconds. 1. Temperature: 235 ± 5 °C / Dipping time: 2 ± 0.5 s 2. Temperature: 245 ± 5 °C / Dipping time: 3 ± 0.5 s (lead free) Depth of immersion: 10mm	The solder should cover over 95% of the critical area of each termination

TEST	TEST METHOD	PROCEDURE	REQUIREMENTS
Rapid change of temperature	IEC 60384-21/22 4.11	<p>Preconditioning; 150 +0/-10 °C for 1 hour, then keep for 24 ±1 hours at room temperature</p> <p>5 cycles with following detail: 30 minutes at lower category temperature 30 minutes at upper category temperature</p> <p>Recovery time 24 ±2 hours</p>	<p>No visual damage</p> <hr/> <p><General purpose series> $\Delta C/C$ Class2: Y5V: ±20%</p> <p><High Capacitance series> $\Delta C/C$ Class2: Y5V: ±20%</p> <hr/> <p>D.F. meet initial specified value R_{ins} meet initial specified value</p>
Damp heat with U_r load	4.13	<ol style="list-style-type: none"> Preconditioning, class 2 only: 150 +0/-10 °C /1 hour, then keep for 24 ±1 hour at room temp Initial measure: Spec: refer initial spec C, D, IR Damp heat test: 500 ±12 hours at 40 ±2 °C; 90 to 95% R.H. 1.0 U_r applied Recovery: Class 2: 24 ±2 hours Final measure: C, D, IR <p>P.S. If the capacitance value is less than the minimum value permitted, then after the other measurements have been made the capacitor shall be precondition according to "IEC 60384 4.1" and then the requirement shall be met.</p>	<p>No visual damage after recovery</p> <hr/> <p><General purpose series> $\Delta C/C$ Class2: Y5V: ±30% D.F. Class2: Y5V: ≤ 15% R_{ins} Class2: Y5V: ≥ 500 MΩ or $R_{ins} \times C_r \geq 25s$ whichever is less</p> <p><High Capacitance series> $\Delta C/C$ Class2: Y5V: ±30% D.F. Class2: Y5V: 2 x initial value max R_{ins} Class2: Y5V: 500 MΩ or $R_{ins} \times C_r \geq 25s$ whichever is less</p>



TEST	TEST METHOD	PROCEDURE	REQUIREMENTS
Endurance	IEC 60384-21/22 4.14	1. Preconditioning, class 2 only: 150 +/-10 °C /1 hour, then keep for 24 ±1 hour at room temp 2. Initial measure: Spec: refer initial spec C, D, IR 3. Endurance test: Temperature: Y5V: 85 °C Specified stress voltage applied for 1,000 hours: Applied 2.0 × U _r for general product. Applied 1.5 × U _r for high cap. product. 4. Recovery time: 24 ±2 hours 5. Final measure: C, D, IR P.S. If the capacitance value is less than the minimum value permitted, then after the other measurements have been made the capacitor shall be precondition according to "IEC 60384 4.1" and then the requirement shall be met.	No visual damage <hr/> <General purpose series> ΔC/C Class2: Y5V: ±30% D.F. Class2: Y5V: ≤ 15% R _{ins} Class2: Y5V: ≥ 1,000 MΩ or R _{ins} × C _r ≥ 80s whichever is less <High Capacitance series> ΔC/C Class 2: Y5V: ±30% D.F. Class 2: Y5V: 2 × initial value max R _{ins} Class 2: Y5V: 1,000 MΩ or R _{ins} × C _r ≥ 50s whichever is less
		Specified stress voltage applied for 1~5 seconds U _r ≤ 100 V: series applied 2.5 U _r Charge/Discharge current is less than 50 mA	No breakdown or flashover

REVISION HISTORY

REVISION	DATE	CHANGE NOTIFICATION	DESCRIPTION
Version 8	Mar. 7, 2017	-	- 0805 L4 spec updated
Version 7	Dec. 9, 2016	-	- Soldering recommendation update
Version 6	Jan. 12, 2016	-	- Update capacitance range & thickness
Version 5	Jul 29, 2010	-	- Modify the last 2-digit of I2NC
Version 4	Jun 24, 2010	-	- Dimension on I206 case size updated
Version 3	Apr 22, 2010	-	- Dimension updated
Version 2	Feb 04, 2010	-	- The statement of "Halogen Free" on the cover added
Version 1	Nov 04, 2009	-	- Ordering code updated - Dimension updated
Version 0	Apr 15, 2009	-	- New datasheet for general purpose and high capacitance Y5V series with RoHS compliant - Replace the "6.3V to 50V" part of pdf files: Y5V_6.3V_10V_9_Preliminary, Y5V_10V-to-50V_10_Preliminary, Y5V_16V_25V_50V_11 - Combine 0201 from pdf files: UP-NPOX5RX7RY5V_0201_6.3-to-50V_2 and UY-NPOX5RX7RY5V_0201_6.3-to-50V_2 - Define global part number - Description of "Halogen Free compliant" added - Test method and procedure updated

Looking for pricing, stock, or lifecycle information?

Click below to explore more details on WIN SOURCE:

-  [View C0603ZRY5V8BB683 on WIN SOURCE](#)
-  [Yageo Information](#)

Optimize Your Supply Chain with WIN SOURCE Solutions

-  Global Sourcing Solution
-  Obsolete Management
-  Cost Control Management
-  Shortage Management
-  Alternative Solution
-  Excess Inventory Management