



**THE DATASHEET OF
ECASD41A476M025K00**



ROHS-Y

SPECIFICATION

For Reference

Date : 6/October /2020

Product Description : Polymer Aluminum Electrolytic Capacitor

Customer Part Number :

Murata Part Number : ECAS*****K00 Series

Murata Manufacturing Co.,Ltd.
Chemical Device Dept.
Sales Promotion Sec.

(Company name/Dept.)

All specifications may be changed without notice.
Please check with our sales representatives or product engineers before ordering.

1. Scope

These specifications are applied to Polymer Aluminum Electrolytic Capacitor for electronic equipment use.

Please contact us beforehand when you use it besides this use.

2. Part Number Description

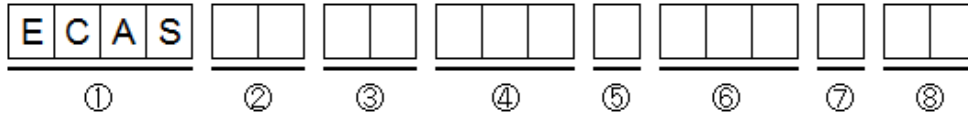

- ① Series : ECAS
- ② Dimensions : See 3.1
- ③ Rated Voltage : See 3.2
- ④ Capacitance : See 3.3
- ⑤ Capacitance Tolerance : See 3.4
- ⑥ ESR : See 3.5
- ⑦ Packing : See 3.6
- ⑧ Individual Specification Code : Murata management Code

3. Descriptions

3.1 Dimensions (mm)

Case Code	L	W	T	W1	S
D3	7.3±0.3	4.3±0.2	1.4±0.1	2.4±0.2	1.3±0.2
D4	7.3±0.3	4.3±0.2	1.9±0.1	2.4±0.2	1.3±0.2
D6	7.3±0.3	4.3±0.2	2.8±0.3	2.4±0.2	1.3±0.2
D9	7.3±0.3	4.3±0.3	4.2±0.3	2.4±0.2	1.3±0.2

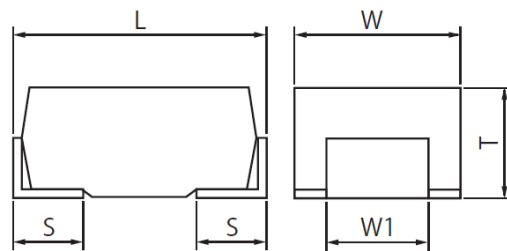

3.2 Rated Voltage

Code	Voltage
0D	2V
0E	2.5V
0G	4V
0J	6.3V
0K	8V
1A	10V
1B	12.5V
1C	16V
1E	25V

3.3 Capacitance

These code are shown by three-digit numeric. The unit is pico-farad (pF). The first and the second figures show the significant digits of the nominal capacitance, and the third figure shows the number of "0" following the significant digit.

Ex.)

Code	Capacitance
476	47 μ F
107	100 μ F
227	220 μ F
477	470 μ F

3.4 Capacitance Tolerance

Code	Tolerance
M	$\pm 20\%$
Y	+10, -35%

3.5 ESR

These code are shown by three-digit alphanumeric. The unit is milli-ohm (m Ω). If there is a decimal point, it is expressed by the capital letter "R".

Ex.)

Code	ESR
4R5	4.5m Ω
009	9m Ω
010	10m Ω

3.6 Packing

Code	Specification
K	$\Phi 330$ mm plastic taping packing

3.7 Individual Specification Code

Expressed by two figures.

4. Part Number and Minimum Packaging Quantity

4.1 Part Numbers and Standards

Murata Part Number	Rated Voltage (V.DC)	Cap. (μ F)	Cap Tol. (%)	Case Size	ESR (m Ω) 100kHz/ +25°C	Leakage Current (μ A)	Ripple Current (Arms) 100kHz
ECASD40D107M016K00	2	100	\pm 20	D4	16	20.0	2.0
ECASD40D157M009K00	2	150	\pm 20	D4	9	30.0	3.0
ECASD40D227M009K00	2	220	\pm 20	D4	9	44.0	3.0
ECASD60D337M007K00	2	330	\pm 20	D6	7	66.0	3.5
ECASD60D477M4R5K00	2	470	\pm 20	D6	4.5	94.0	4.0
ECASD60D477M006K00	2	470	\pm 20	D6	6	94.0	3.5
ECASD60E477M4R5K00	2.5	470	\pm 20	D6	4.5	117.5	4.0
ECASD60E477M006K00	2.5	470	\pm 20	D6	6	117.5	3.5
ECASD60E477M009K00	2.5	470	\pm 20	D6	9	117.5	3.0
ECASD40G686M020K00	4	68	\pm 20	D4	20	27.2	1.9
ECASD40G107M016K00	4	100	\pm 20	D4	16	40.0	2.1
ECASD40G157M016K00	4	150	\pm 20	D4	16	60.0	2.1
ECASD40G227M009K00	4	220	\pm 20	D4	9	88.0	3.0
ECASD60G227M010K00	4	220	\pm 20	D6	10	88.0	3.0
ECASD40J106M055K00	6.3	10	\pm 20	D4	55	6.3	1.0
ECASD40J226M045K00	6.3	22	\pm 20	D4	45	13.9	1.0
ECASD40J336M025K00	6.3	33	\pm 20	D4	25	20.8	1.8
ECASD40J476M025K00	6.3	47	\pm 20	D4	25	29.7	1.8
ECASD40J686M015K00	6.3	68	\pm 20	D4	15	42.9	2.0
ECASD40J107M015K00	6.3	100	\pm 20	D4	15	63.0	2.0
ECASD40J157M015K00	6.3	150	\pm 20	D4	15	94.5	2.0
ECASD60J157M010K00	6.3	150	\pm 20	D6	10	94.5	3.0
ECASD60J227M010K00	6.3	220	\pm 20	D6	10	138.6	3.0
ECASD41A106M055K00	10	10	\pm 20	D4	55	10.0	1.0
ECASD41A226M028K00	10	22	\pm 20	D4	28	22.0	1.6
ECASD41A336M025K00	10	33	\pm 20	D4	25	33.0	1.8
ECASD41A476M025K00	10	47	\pm 20	D4	25	47.0	1.8
ECASD61A686M015K00	10	68	\pm 20	D6	15	68.0	2.0
ECASD41C685M070K00	16	6.8	\pm 20	D4	70	10.9	1.0
ECASD41C106M060K00	16	10	\pm 20	D4	60	16.0	1.0
ECASD41C156M040K00	16	15	\pm 20	D4	40	24.0	1.0
ECASD61C226M030K00	16	22	\pm 20	D6	30	35.2	1.6

4.2 Minimum Packaging Quantity

Case Size	Minimum Packaging Quantity(pcs)
D3	3,000
D4	3,000
D6	2,500
D9	2,000

5. Markings

The diagram shows a capacitor with a polarity indicator bar (+) at the top and a minus sign (-) at the bottom. The rated voltage is indicated by two digits in a box, and the capacitance code is indicated by three digits in a box. Arrows point from the text labels to the corresponding parts of the capacitor diagram.

Polarity indicator bar (+)

Rated Voltage (2 digits)

Code	Voltage
0D	2V
0E	2.5V
0G	4V
0J	6.3V
0K	8V
1A	10V
1B	12.5V
1C	16V
1E	25V

Capacitance Code (3 digits)

Code	Capacitance
476	47μF
107	100μF
227	220μF
477	470μF

6. Characteristics

No	Item	Characteristics	Test Conditions
1	Operating temperature range	-40°C ~ +105°C	-
2	Leakage Current	≤ The value of No.4.1	Series resistor: 1000 ohm Applied voltage: Rated Voltage Measuring after 2 minutes of application Please conduct pre-conditioning below, if you have a doubt. Pre-conditioning: • Temperature: 105°C. • Applied voltage :Rated Voltage • Series resistor:1000 ohm • Charge time:1 hour. Then discharge and keep in the room temperature for 4h to 24h.
3	Capacitance tolerance	(See No.4.1)	Measuring frequency: 120Hz ±10% Measuring circuit: Equivalent series circuit Measuring voltage: +1Vr.m.s. Measuring temperature: 25 °C
4	Dissipation Factor	≤ 0.06	
5	ESR	≤ The value of No.4.1	Measuring frequency: 100kHz ±10% Measuring voltage: no more than +1Vr.m.s. Measuring temperature: 25 °C
6	Allowable Ripple Current	(See No.4.1)	Measuring frequency: 100kHz ±10% Part temperature: +20 to +105 °C
7	Solderability	More than 75% of each terminal face is covered by new solder	Lead Free Solder : Sn/3.0Ag/0.5Cu Flux : Rosin 25%, IPA 75% Solder Temperature : 245±3°C Immersing Duration : 3±0.3sec

No.	Item	Characteristics	Test Conditions	
8	Moisture resistance under no bias	Leakage Current	Test temperature: 60±2°C Relative humidity: 90~95%RH Test time: 500+24, -0h	
		Capacitance Change		$\leq 300\%$ of initial specified value $\leq 750\%$ of initial specified value(ECAS D40J157M015K00)
		Dissipation Factor		-20% and +50% of initial measured value
		Appearance		≤ 0.12 No defects or abnormalities
9	Moisture resistance under load	Leakage Current	Test temperature: 60±2°C Relative humidity: 90~95%RH Test time: 500+24, -0h Applied voltage: Rated Voltage	
		Capacitance Change		\leq The value of No.4.1
		Dissipation Factor		-20% and +50% of initial measured value
		Appearance		≤ 0.12 No defects or abnormalities
10	Shelf life	Leakage Current	Test temperature: 105±2°C Test time: 1000+48, -0h	
		Capacitance Change		\leq The value of No.4.1
		Dissipation Factor		±10% of initial measured value
		Appearance		≤ 0.06 No defects or abnormalities
11	Endurance	Leakage Current	Test temperature: 105±2°C Test time: 2000+48, -0h Applied voltage: Rated Voltage	
		Capacitance Change		\leq The value of No.4.1
		Dissipation Factor		±20% of initial measured value
		Appearance		≤ 0.06 No defects or abnormalities
12	Surge	Leakage Current	Temperature: +85°C for W.V. 2V~10V Room temp. for W.V. 12.5V~16V Applied voltage: Rated voltage x1.25 for W.V.2V~10V Rated voltage x1.15 for W.V.12.5V~16V Current Limiting resistance: 33 ohm(in series) for W.V. 2V~10V 1k ohm(in series) for W.V. 12.5V~16V Discharge resistance: 33 ohm(in series) for W.V. 2V~10V 1k ohm(in series) for W.V. 12.5V~16V Charge on/off: 30 sec. each, 1000 times	
		Capacitance Change		\leq The value of No.4.1
		Dissipation Factor		±10% of initial measured value
		Appearance		≤ 0.06 No defects or abnormalities

The measurement condition in No.2 to 4 applies to No.8 to 12.

- 7. Packaging
- 7.1 Carrier Tape Configuration and Dimension

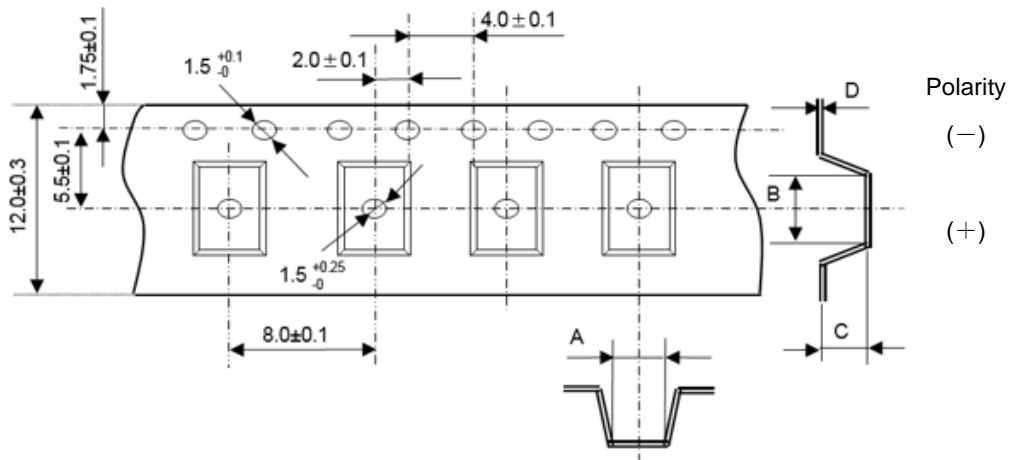

Type	Cavity Size (mm)				Minimum Qty. (pcs)
	A*	B*	C*	D*	
D3, D4	4.60	7.65	2.16	0.23	3,000
D6	4.60	7.65	3.20	0.27	2,500
D9	4.45	7.65	4.55	0.28	2,000

* Nominal values

7.2 Tape Packaging

Capacitors will be inserted in embossed carrier tape that will be sealed with cover tape as described below. No more than half of a sprocket hole will be covered by cover tape.

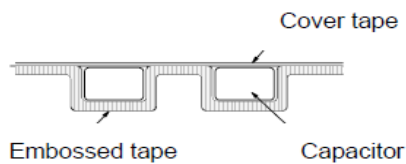

7.3 Taping Leader

Tape has a leader and a trailer as described below.

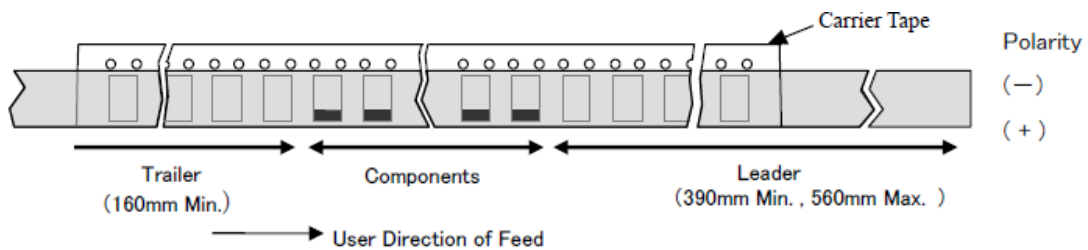

7.4 Cover Tape Peel Strength

Cover tape peel strength required to be within the range of 0.1-0.8N when tested as below .

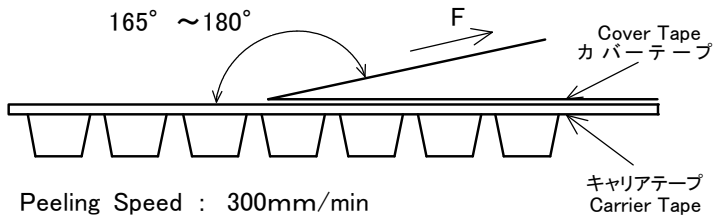

7.5 Empty Cavities of Carrier Tape Section

Empty cavities of filled section must be lower than 0.1% or 1pc of the total of reel quantity and sequential empty cavities are not allowed. Devices placed in one reel must satisfy the specified reel quantity.

7.6 Reel Configuration and Dimension

Tape with capacitors is wound in a reel as described below.

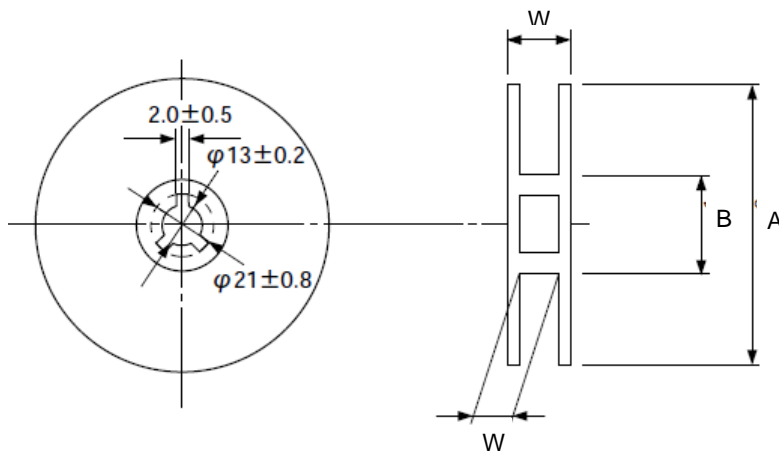

Reel Size	Tape Width	A	B	W	W1
Φ330	12	330.0 ±2.0	100.0 ±1.0	17.4 ±1.5	13.4 ±1.5

(mm)

7.7 Labels on Reel

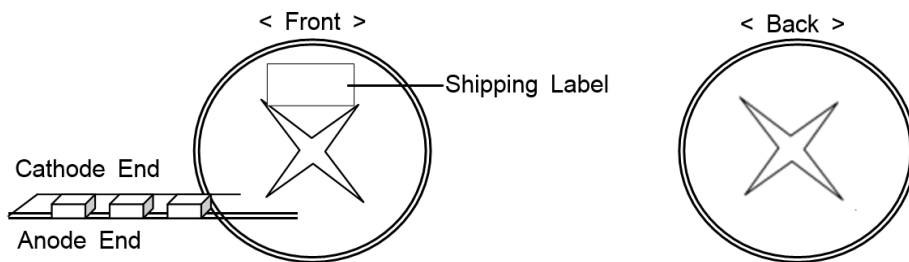

Shipping Label that show the customer parts number, our parts number, our company name, inspection number and quantity, will be put in outside of reel.

Please note the position of sipping label when feeding a tape.

7.8 Moisture Proof Aluminum Laminated Bag Packaging

A reel of the products is packaged in a moisture proof aluminum laminated bag and labels are put on the bag as shown below. One desiccant and a humidity indicator are put on the backside of the reel before slightly drawing the vacuum and sealing the bag.

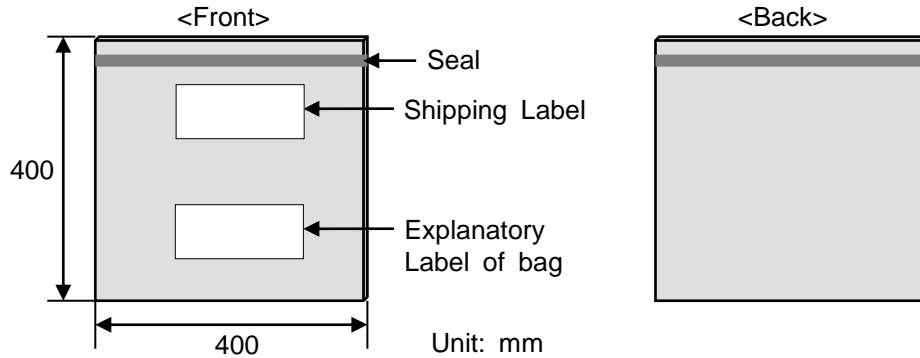

Note) The size of the Moisture Proof Aluminum Laminated Bag is a rough value.

7.9 Cardboard Box Packaging

Moisture proof aluminum laminated bags of products are packaged in a cardboard box.

8. Quality Assurance

<1> Murata's responsibility for the quality of this product shall be limited to those specified in this document.

<2> It is a customer's responsibility to judge fitness of this product for assembly process, end use and operating environment.

9. Caution for Use



Caution

9.1 Limitation of the use

Please contact us before using our products for the applications listed below which require especially high reliability for the prevention of defects which might directly cause damage to the third party's life, body or property.

① Aircraft equipment ② Aerospace equipment ③ Undersea equipment ④ Power plant control equipment
⑤ Medical equipment ⑥ Transportation equipment (vehicles, trains, ships, etc.) ⑦ Traffic signal equipment
⑧ Disaster prevention/crime prevention equipment ⑨ Data-processing equipment ⑩ Application of similar complexity and/or reliability requirements to the applications listed in the above.



Caution

9.2 Storage Condition

<1> Term of warranty for this product is two years after packaging in a moisture-proof bag, under the conditions below with sealed packaging.

Recommended storage environment Room temperature: 5-30 degree

Humidity: no more than 60%RH

<2> Polymer aluminum electrolytic capacitors should not be stored in an atmosphere consisting of corrosive gas (e.g. hydrogen sulfide, sulfur dioxide, chlorine, ammonia gas, etc.).

<3> Polymer aluminum electrolytic capacitors should be stored in a dry atmosphere, avoiding direct sunlight and condensation. If capacitors are kept at a higher humidity, the following problems may occur:

① Leakage current will increase at the beginning of use and damage the circuit.

② Moisture absorbed in a resin will evaporate and expand with heat of mounting and damage the mold resin.

<4> Please confirm a dry state with a humidity indicator card after open immediately. If 20% indication was in a pink state after opened, it is recommended to bake under the conditions below.

<5> The capacitors should be kept dry using desiccators or any other methods after unsealing the moisture-proof packaging. If more than one week has passed under the recommended storage environment specified above after unsealing the packaging, it is recommended to bake under the conditions below.

Recommended baking conditions Temperature: 60(+0, -5) degree C

Time: 168 hours

<6> This product meets MSL-3.



Caution

9.3 Cautions for Use

<1> Prohibited Circuits for use

Do not use the capacitor with the following circuit.

- ① Time-constant circuit
- ② Coupling circuits
- ③ 2 or more capacitors connected serially
- ④ Circuit which are greatly affected by leakage current

<2> Polarity

Polymer aluminum electrolytic capacitor is polarized. Please not to reverse the polarity when using. If reverse voltage is applied even momentary, it may damage the oxide film and the capacitor itself. Please verify the orientation of the capacitor before use in accordance with the drawing of "Markings" in Item 5.

<3> Operating Voltage

When DC-rated capacitors are to be used in AC or ripple current circuits, be sure to maintain the Vo-p value of the applied voltage or the Vo-p which contains DC bias within the rated voltage range. When the voltage is applied to the circuit, starting or stopping may generate irregular voltage for a transit period because of resonance or switching. Be sure to use a capacitor with a rated voltage range that includes these irregular voltages.

<4> Inrush Current

Extreme inrush current may cause short circuit or leakage current increase. If the inrush current exceeds 20A, adding protection circuit is recommended.

<5> Allowable Ripple Current

Please not to apply ripple current exceeding the allowable value specified in the standards in Item 4.1. If excessive current is applied, it may generate heat and the heat may damage the capacitor. The sum of DC voltage and the peak AC voltage shall not exceed the rated voltage. The sum of the DC voltage and the peak AC voltage shall not allow a voltage reversal.

<6> Operating Temperature

The operating temperature limit depends on the capacitor.

- ① Do not apply temperature exceeding the upper operating temperature. It is necessary to select a capacitor with a suitable rated temperature that will cover the operating temperature range. Also it is necessary to consider the temperature distribution in equipment and the seasonal temperature variable factor.
- ② Consider the self-heating of the capacitor. The surface temperature of the capacitor shall be the upper operating temperature or less when including the self-heating factors.

< 7 > Reflow Soldering

- ① Please not to apply excessive force to the capacitor during insertion as well as after soldering.
The excessive force may result in damage to electrode terminals and/or degradation of electrical performance.
- ② Resistance testing to reflow soldering was conducted in accordance with the reflow profile described in Figure 1. If this profile is adopted, reflow soldering can be repeated no more than two times.

< Figure 1. > Our Recommended Reflow Profile

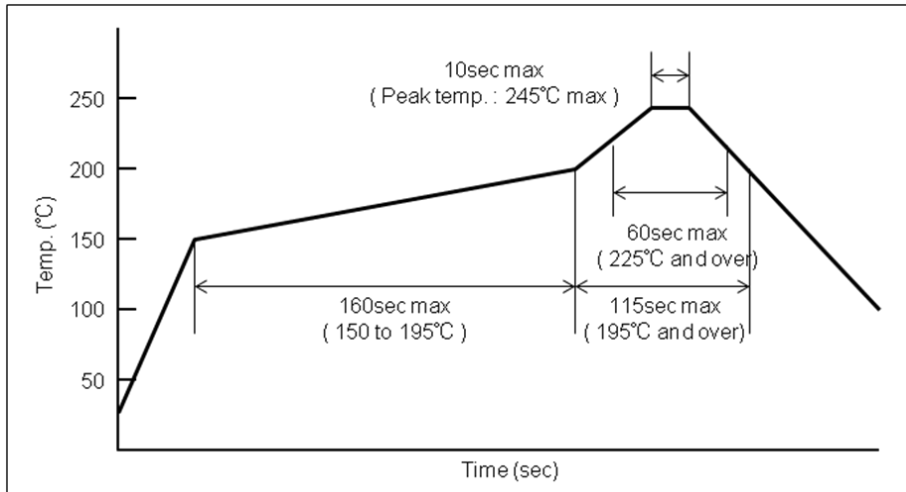

- ③ Please refer to figure below for designing land pattern.

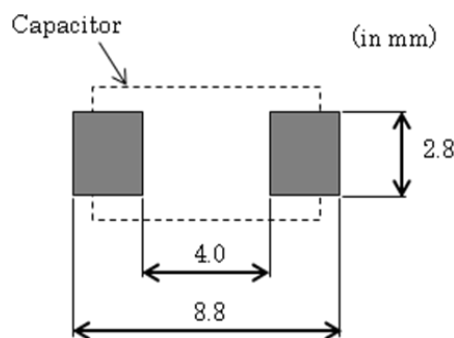

< 8 > Operating environment

Confirm the environment in which the equipment will operate is under the specified conditions. Do not use the equipment under the following environments.

- ① Being spattered with water or oil.
- ② Being exposed to direct sunlight.
- ③ Being exposed to Ozone, ultraviolet rays or radiation.
- ④ Being exposed to toxic gas (e.g. hydrogen sulfide, sulfur dioxide, chlorine, ammoniagas, etc.)
- ⑤ Being exposed to excessive vibrations or mechanical shocks.
- ⑥ Being exposed to condensable environments.

< 9 > Disposal

Polymer aluminum electrolytic capacitors should be disposed of as industrial waste in accordance with laws.

9.4 Manufacturing factory

Murata Electronics (Thailand), Ltd.



10. Proposal

- ① When you use, please evaluate in a state mounted by your product.
- ② Please do not use this product other than the mention contents of this specification.
- ③ We think that it is not appropriate to mention a contract matter about the business in specifications, a drawing, other technical documentations.

Therefore, we invalidate it when there is a mention about the range of the responsibility of us such as a guarantee of quality, PL, industrial property, the export control in these technical documentations that your company was made.

Please offer these matters separately in the basic contract document etc.

Looking for pricing, stock, or lifecycle information?

Click below to explore more details on WIN SOURCE:

-  [View ECASD41A476M025K00 on WIN SOURCE](#)
-  [Murata Electronics North America Information](#)

Optimize Your Supply Chain with WIN SOURCE Solutions

-  Global Sourcing Solution
-  Obsolete Management
-  Cost Control Management
-  Shortage Management
-  Alternative Solution
-  Excess Inventory Management