

EVALUATION BOARD OVERVIEW

This data sheet describes the design and setup of the EVAL-ADAU1701MINIZ, the ADAU1701 SigmaDSP® mini evaluation board. The EVAL-ADAU1701MINIBZ provides stereo line-level analog audio input as well as a digital audio interface. Two of the ADAU1701 DAC channels are routed to an SSM2306 filterless Class-D amplifier, while the other two channels are routed to line-level outputs.

The ADAU1701 can be controlled via the USBi interface control board connected to the I²C communications interface. On-board self-boot EEPROM is included for operating the board independently of the Analog Devices, Inc., SigmaStudio™ software. Push-buttons, LEDs, and a potentiometer are connected directly to the ADAU1701 GPIO pins for user control.

This evaluation board can also be used to evaluate the Analog Devices ADAU1702 and ADAU1401 audio processors. Visit www.analog.com for details about the differences between these integrated circuits.

PACKAGE CONTENTS

The EVAL-ADAU1701MINIZ package contents include

- The ADAU1701 mini evaluation board
- A USBi control interface board
- A USB cable
- SigmaStudio software
- Evaluation board documentation

OTHER SUPPORTING DOCUMENTATION

When using this evaluation board, refer to the following documentation available at www.analog.com:

- [ADAU1701](#), [ADAU1702](#), and [ADAU1401](#) data sheets
- [SSM2306](#) data sheet
- AN-923 Application Note, *Designing a System Using the ADAU1701/ADAU1702 in Self-Boot Mode*
- AN-951 Application Note, *Using Hardware Controls with SigmaDSP GPIO Pins*
- SigmaStudio Help software (included in the package)

FUNCTIONAL BLOCK DIAGRAM

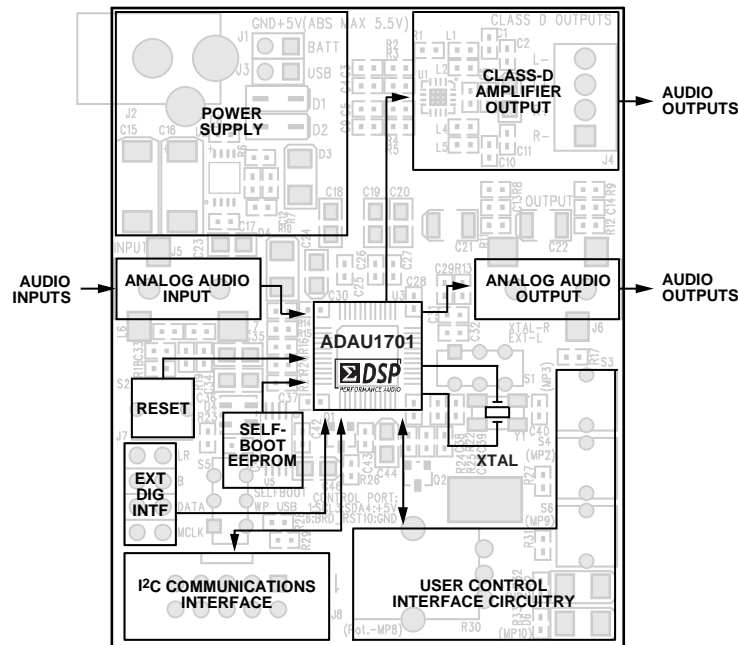

Figure 1.

Rev. 0

Evaluation boards are only intended for device evaluation and not for production purposes. Evaluation boards are supplied "as is" and without warranties of any kind, express, implied, or statutory including, but not limited to, any implied warranty of merchantability or fitness for a particular purpose. No license is granted by implication or otherwise under any patents or other intellectual property by application or use of evaluation boards. Information furnished by Analog Devices is believed to be accurate and reliable. However, no responsibility is assumed by Analog Devices for its use, nor for any infringements of patents or other rights of third parties that may result from its use. Analog Devices reserves the right to change devices or specifications at any time without notice. Trademarks and registered trademarks are the property of their respective owners. Evaluation boards are not authorized to be used in life support devices or systems.

TABLE OF CONTENTS

Evaluation Board Overview	1	Analog Audio Input	5
Package Contents.....	1	Analog Audio Line Output	5
Other Supporting Documentation.....	1	Class-D Amplifier Output.....	5
Functional Block Diagram	1	Clocking the Evaluation Board	5
Revision History	2	External Digital Audio Input	5
Setting Up the Evaluation Board	3	I ² C Communications Header	6
Quick Start.....	3	Self-Boot EEPROM.....	6
Installing SigmaStudio Software.....	3	GPIO Interface.....	6
Setting up the Hardware	3	Writeback Trigger Transistor	7
Powering Up the Board	3	Reset	7
Connecting the Audio Cables.....	3	Schematics	8
Setting Switches and Jumpers	3	Board Silkscreen and Parts Placement	9
The First SigmaStudio Project—EQ Filter and Aux Volume Control.....	3	Ordering Information.....	10
Using the Evaluation Board.....	5	Bill of Materials.....	10
ADAU1701 SigmaDSP.....	5	Ordering Guide	12
Power Supply.....	5	ESD Caution.....	12

REVISION HISTORY

5/09—Revision 0: Initial Version

SETTING UP THE EVALUATION BOARD

QUICK START

To quickly get started with the evaluation board, install the SigmaStudio software, plug in the USBi, power up the board, connect the audio cables, and set the switches and jumpers.

INSTALLING SIGMASTUDIO SOFTWARE

1. Open the provided zip file and extract the files to your PC. Alternately, insert the SigmaStudio CD into the PC optical drive and select the SigmaStudio folder.
2. Install Microsoft .NET Framework version 2.0, if it has not been previously installed. To do so, double-click **dotnetfx.exe**.
3. Double-click **setup.exe** and following the prompts. A computer restart is not required.

SETTING UP THE HARDWARE

1. Plug in the USBi into the control port on the evaluation board (see Figure 2).
2. Connect the USB cable to your computer and to the USBi.
3. When prompted for a driver, select **Install from a list or a specific location**.
4. Select **Search for the best driver in these locations**.
5. Check the box for **Include this location in the search**. The USBi driver is located in **C:\Program Files\Analog Devices Inc\Sigma Studio\USB drivers**.
6. Click **Next**.
 - If prompted to choose a driver, select **CyUSB.sys**.
 - If a message appears in XP stating that the software has not passed Windows Logo testing, click **Continue Anyway**.

POWERING UP THE BOARD

The evaluation board can be powered either by the USBi or by the power supply provided with the board. For the board to run independently from the computer, disconnect Jumper J3 and connect the power supply at J2 (see Figure 2). The power indicator LED, D3 (see Figure 2), should be lit.

CONNECTING THE AUDIO CABLES

Set up the evaluation board by connecting the stereo analog inputs and stereo analog outputs, using 1/8" cables. To do so:

1. Connect the audio source to the input J5 jack (see Figure 2).
2. Connect the output J6 jack to your speakers or headphones (see Figure 2).

SETTING SWITCHES AND JUMPERS

To configure the evaluation board for stereo analog input and output, set the switches and jumpers as shown in Figure 2.

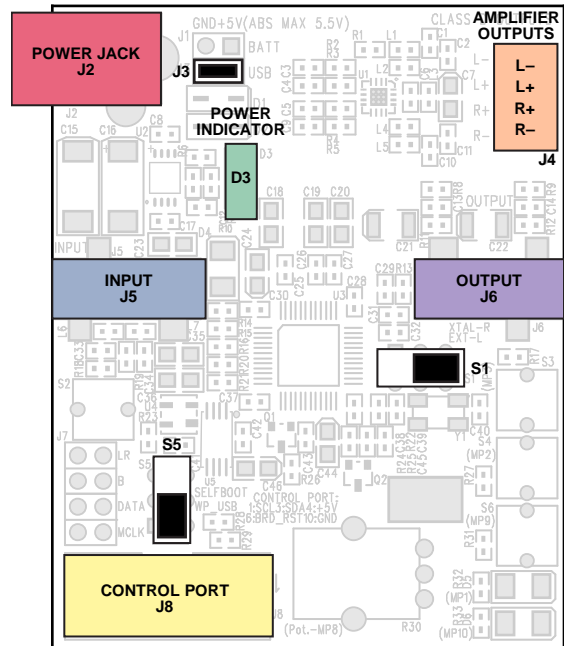

Figure 2. Evaluation Board Setup and Configuration

THE FIRST SIGMASTUDIO PROJECT—EQ FILTER AND AUX VOLUME CONTROL

To create a new SigmaStudio project, follow the steps outlined below. To complete the steps, you will be working with the **Hardware Configuration** tab of the software shown in Figure 3.

1. Drag an ADAU1701 and a USBi cell from the **Tree Toolbox** into the blank white space of the **Hardware Configuration** tab. If you are using a processor other than the ADAU1701 (for example, the ADAU1401 or the ADAU1702), then drag that processor.
2. Connect the USBi cell to the ADAU1701 cell by clicking and dragging from the top blue output pin to the green input pin. Your screen should now appear as shown in Figure 3.

EVAL-ADAU1701MINIZ

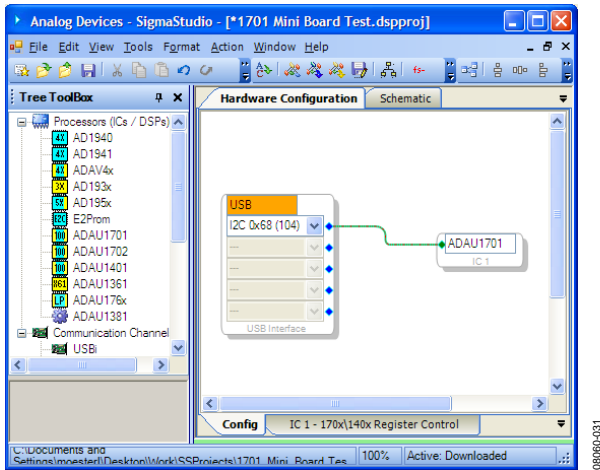

Figure 3. Hardware Configuration Tab

To complete the following steps, you will be working with the **Schematic** tab.

1. Click on the **Schematic** tab.
2. In the **Tree Toolbox**, expand the **IO** folder, then select **Input**. Click and drag an **Input** cell to the work area.
3. In the **IO** folder, select **GPIO**, then select **Input**. Click and drag an **Auxiliary ADC Input** to the work area.
4. On the **Auxiliary ADC Input** cell, labeled **ADC In1**, select **AUX_ADC_3** from the pull-down menu.
5. Expand **Filters**, select **Second Order**, then select **Single Precision**, then select **2 Ch**, and click and drag **Medium Size Eq**.
6. Right-click the **General (2nd Order)** cell labeled **Gen Filter1**, click **Grow Algorithm**, then select **1. 2 Channel-Single Precision**, and then select **4**. This creates a five band EQ. Each band's general filter settings can be modified by clicking the blue boxes on the cell.
7. Expand **Volume Controls**, then select the following: **Adjustable Gain**, then **Ext Control**, then **Clickless SW Slew**, and then click and drag **Single slew ext vol**.
8. Expand **Muxes/Demuxes** and then select **Switch**, then select **2 Ch** and then click and drag **Stereo Switch 2xN**.
9. Expand **IO** and select **Output**. Click and drag four **Output** cells to the work area.
10. For each of the outputs select a DAC output from the pull-down menu. **DAC0** and **DAC1** are amplifier left and right outputs (J4 on the board marked in Figure 2, respectively). **DAC2** and **DAC3** are left and right channel outputs, respectively, for the stereo lineout output (J6 on is shown in Figure 2).
11. Connect all the cells as depicted in Figure 4.

To complete the steps, you will be working with the **Hardware Configuration** tab.

1. In the **Hardware Configuration** tab under the **GPIO** box (see Figure 5), select the pull-down menu next to **MP8** and set for **ADC3**. This allows the rotary potentiometer on the board to be used as a volume control in conjunction with the **Auxiliary ADC Input** cell in the schematic window (see Figure 5).
2. Make sure your project board is powered and connected to the PC.
3. Select the **Link-Compile-Download** button in SigmaStudio. If the project compiled without error, you will be in **Ready-Download** mode.

Your screen should now appears as shown in Figure 4.

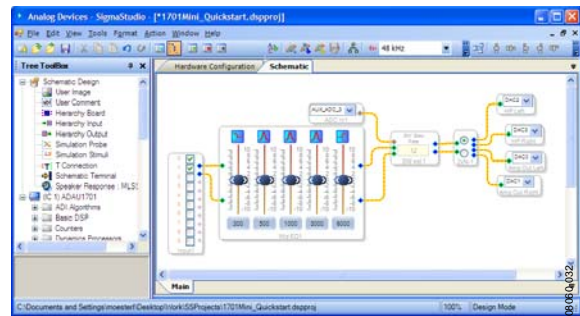

Figure 4. Schematic Tab, Full Design

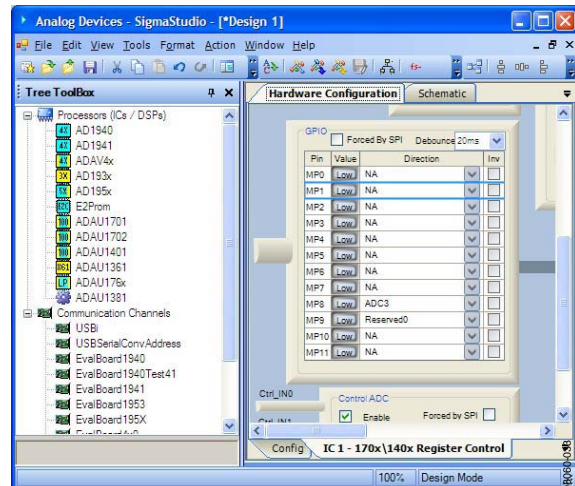

Figure 5. Hardware Configuration, GPIO Setting

Once you start the audio source and hear the audio playing, you can rotate the potentiometer on the board to control the volume in real time and affect the audio output.

USING THE EVALUATION BOARD

ADAU1701 SIGMADSP

The ADAU1701 is a complete, single-chip, audio system with a 28-bit/56-bit audio DSP, ADCs, DACs, and microcontroller-like control interfaces. Signal processing, which includes equalization, crossover, bass enhancement, multiband dynamics processing, delay compensation, speaker compensation, and stereo image widening, can be used to compensate for real-world limitations of speakers, amplifiers, and listening environments, providing dramatic improvements of perceived audio quality.

This signal processing is comparable to that found in high-end studio equipment. Most processing is done in full 56-bit, double-precision mode, resulting in very good low level signal performance. The ADAU1701 is a fully programmable DSP. The easy-to-use SigmaStudio software allows the user to graphically configure a custom signal processing flow using blocks, such as biquad filters, dynamics processors, level controls, and GPIO interface controls.

ADAU1701 programs can be loaded on power-up either from a serial EEPROM through its own self-boot mechanism or from an external microcontroller. On power-down, the current state of the parameters can be written back to the EEPROM from the ADAU1701 to be recalled the next time the program is run.

Two Σ - Δ ADCs and four Σ - Δ DACs provide a 98.5 dB analog input to analog output dynamic range. Each ADC has a THD + N of -83 dB, and each DAC has a THD + N of -90 dB. Digital input and output ports allow a glueless connection to additional ADCs and DACs. The ADAU1701 communicates through an I²C® bus or a 4-wire SPI® port.

POWER SUPPLY

The power supply circuit consists of a 5 V to 3.3 V ADP3336 dc regulator, filtering, and an LED indicator. The resistors and capacitor connected to the FB pin of the ADP3336 set the output voltage. Power can be supplied from the USBi board, on power connector J2, or through a battery wired to J1.

When the USBi is used to power the EVAL-ADAU1701MINIZ from the 5 V dc of the USB port (default setting), a jumper should be connected to J3. When an external 5 V dc supply is used on either J1 or J2, the jumper on J3 should be disconnected. On J1, Pin 1 is power and Pin 2 is ground, as labeled on the board's silkscreen.

When the EVAL-ADAU1701MINIZ is powered, LED D3 illuminates green. The ADAU1701 digital circuitry operates off of a 1.8 V supply generated from the IC's on-board regulator and pass transistor, Q1.

ANALOG AUDIO INPUT

Each of the stereo analog input signals connects to an anti-aliasing filter and ac coupling capacitor before connecting to one of the ADAU1701 ADCs. The resistor in series with the ADC input is used in conjunction with the ADC_RES resistor

on the ADAU1701 to set the full-scale rms input voltage of the ADC. In this case, it has been set to 1.0 V rms.

ANALOG AUDIO LINE OUTPUT

The ADAU1701 includes four Σ - Δ DACs. The SNR of the DAC is 104 dB and the THD + N is -90 dB. A full-scale output on the DACs is 0.9 V rms (2.5 V p-p).

The DACs are in an inverting configuration. If a signal inversion from input to output is undesired, it can be reversed. Simply invert the signal in the ADAU1701 DSP program flow.

DAC 2 and DAC 3 are connected to a single-pole, passive low-pass filter with a 50 kHz corner frequency, which is sufficient to filter the DAC out-of-band noise.

CLASS-D AMPLIFIER OUTPUT

DAC 0 and DAC 1 of the ADAU1701 are connected to the SSM2306, a 2 W filterless, Class-D amplifier with a built-in output stage. It drives 2 W into 4 Ω and 1.4 W into 8 Ω . Connect speakers to J4 according to Table 1.

Table 1. J4 Pinout

Pin	SSM2306 Output
1 (bottom)	Right -
2	Right +
3	Left +
4 (top)	Left -

CLOCKING THE EVALUATION BOARD

The ADAU1701 on-chip clock oscillator can drive an external crystal to create a master clock. Switch S1 allows the crystal to be disconnected; an external MCLK signal, input on J7, is used instead (see Table 2). Crystal Y1 is 12.288 MHz, thus, the ADAU1701 runs at a sample rate of 48 kHz (12.288 MHz/256).

Table 2. Master Clock Source Settings

Clock Source	S5 Setting
12.288 MHz Crystal	Right
MCLK from Header J7	Left

EXTERNAL DIGITAL AUDIO INPUT

To use the digital audio input port of the ADAU1701, the serial data, BCLK, and LRCLK signals must be connected to an external source using Header J7. The source needs to be synchronous to the ADAU1701, thus, the MCLK should be input to this header as well. On J7, the row of pins along the edge of the board are ground and the inner row of pins are the signals.

Within the SigmaStudio software, the digital input Channel 0 through Channel 7 are accessed in the input cell in Position 2 through Position 9, as shown in Figure 6. Position 0 and Position 1 are inputs from the ADCs.

EVAL-ADAU1701MINIZ

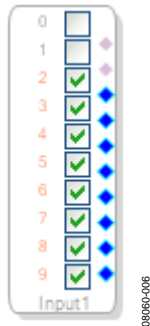

Figure 6. Digital Audio Input 0 through Input 7 in SigmaStudio Input Cell

Configure the corresponding multipurpose pins of the ADAU1701 in SigmaStudio, as shown in Figure 7. Note that these are different pins than those used for serial data input, thus ensuring that there will be no conflict.

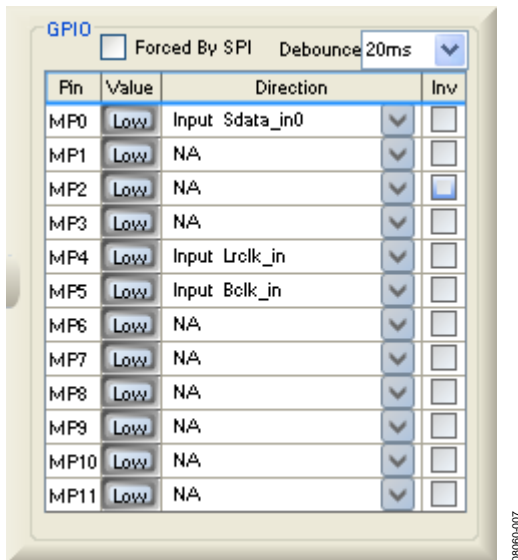

Figure 7. Multipurpose Pin Configuration in SigmaStudio for Digital Audio Input

Table 3. Analog and Digital Audio Connectors

Jack	Function
J4	Amplifier output speaker terminals
J5	Stereo analog line input
J6	Stereo analog line output
J7	Serial data input

I²C COMMUNICATIONS HEADER

The I²C communications Header J8 connects to the ADAU1701 communications port. Along with the I²C signals, a DSP reset signal and USB bus power are included on J8. Typically, the USBi (EVAL-ADUSB2) is connected to this header to enable communications with SigmaStudio. The SigmaStudio hardware configuration for this setup is shown in Figure 8.

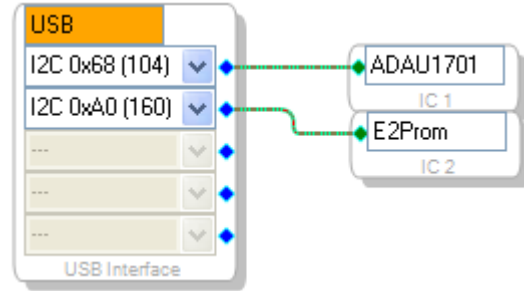

Figure 8. Using the EVAL-ADAU1701MINIZ and the USBi with SigmaStudio

SELF-BOOT EEPROM

SigmaStudio can download a single set of program RAM, parameter RAM, and register settings to the EVAL-ADAU1701MINIZ self-boot EEPROM. To do this, disable the write-protect Switch S5 (set the switch in the down position).

To download from SigmaStudio to the EEPROM, compile the project, then right-click the ADAU1701 in the **Hardware Configuration** tab and select **Write Latest Compilation to E2PROM**, as shown in Figure 9.

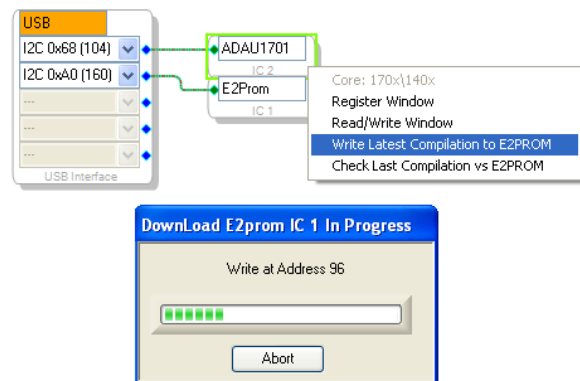

Figure 9. SigmaStudio Downloading to Self-Boot EEPROM

The ADAU1701 automatically self-boots any time the board is powered and the EEPROM contents are valid. Press the reset switch (S2) to ensure that the ADAU1701 self-boots while the board power remains on.

GPIO INTERFACE

The ADAU1701 has 12 multipurpose pins that can be used as digital GPIO or auxiliary ADC inputs. On the EVAL-ADAU1701MINIZ, Pin MP1, Pin MP10, and Pin MP11 are connected to LEDs and used as outputs. Pin MP2, Pin MP3, and Pin MP9 are connected to push-buttons and pull-up resistors and are used as inputs. Pin MP8 is connected to a linear potentiometer and used as an input to the auxiliary ADC. Pin MP7 is connected to the SD pin of the SSM2306 amplifier. This allows the ADAU1701 SigmaDSP to control the power-up/power-down of the SSM2306.

Table 4 shows the ADAU1701 pins connected to the different GPIO functions and the associated settings.

Table 4. GPIO Setup

ADAU1701 Pin	Device	Settings	SigmaStudio Setting
MP1	Yellow LED D5	Active high	Output GPIO
MP2	Push-button S4	Push to ground	Input GPIO debounce, invert
MP3	Push-button S3	Push to ground	Input GPIO debounce, invert
MP7	SSM2306 SD	Active low	Output GPIO
MP8	10 kΩ potentiometer	Clockwise turn lowers resistance	ADC3
MP9	Push-button S6	Push to ground	Input GPIO debounce, invert
MP10	Yellow LED D6	Active high	Output GPIO
MP11	Red LED D4	Active high	Output GPIO

When used in SigmaStudio, the input push-buttons appear as shown in Figure 10.

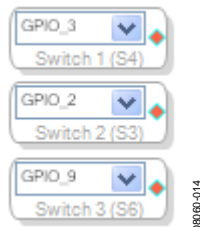

Figure 10. Push-Button Inputs in SigmaStudio

When used in SigmaStudio, the output LEDs appear as shown in Figure 11.

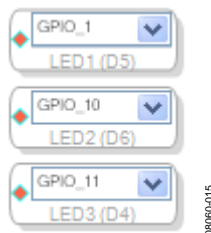

Figure 11. LED Outputs in SigmaStudio

When used in SigmaStudio, the potentiometer input to the auxiliary ADC appears as shown in Figure 12.

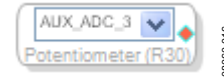

Figure 12. Potentiometer Input in SigmaStudio

The settings in the SigmaStudio register control window appear as shown in Figure 13 when used with the EVAL-ADAU1701MINIZ.

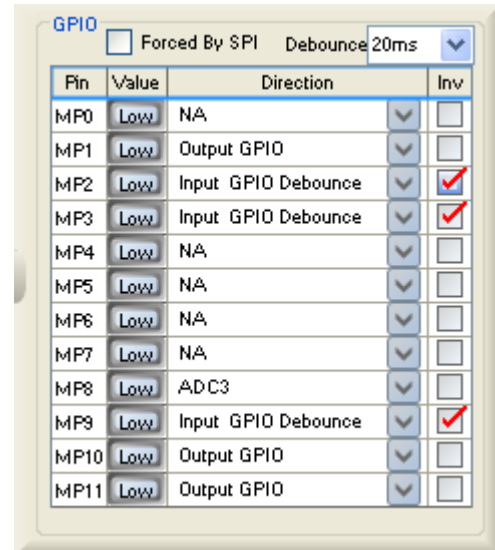

Figure 13. SigmaStudio Multipurpose Pin Configuration for the EVAL-ADAU1701MINIZ

WRITEBACK TRIGGER TRANSISTOR

The writeback trigger transistor circuit is intended to send a high pulse to the ADAU1701 WB pin when the power supply (DVDD) is interrupted. During normal operation, DVDD is high (+5 V), so Transistor Q2 is always turned on, and the WB signal is held low.

When the power supply (DVDD) is removed, the transistor turns off, sending a high pulse on the WB signal line to the ADAU1701. The two large 220 μF capacitors on the regulator hold DVDD high until the data writeback transfer is complete, thus providing adequate supply voltages to the ADAU1701 and the self-boot EEPROM.

RESET

The [ADM811](#) provides a clean active-low reset signal to the ADAU1701 when Switch S2 is pressed.

EVAL-ADAU1701MINIZ

SCHEMATICS

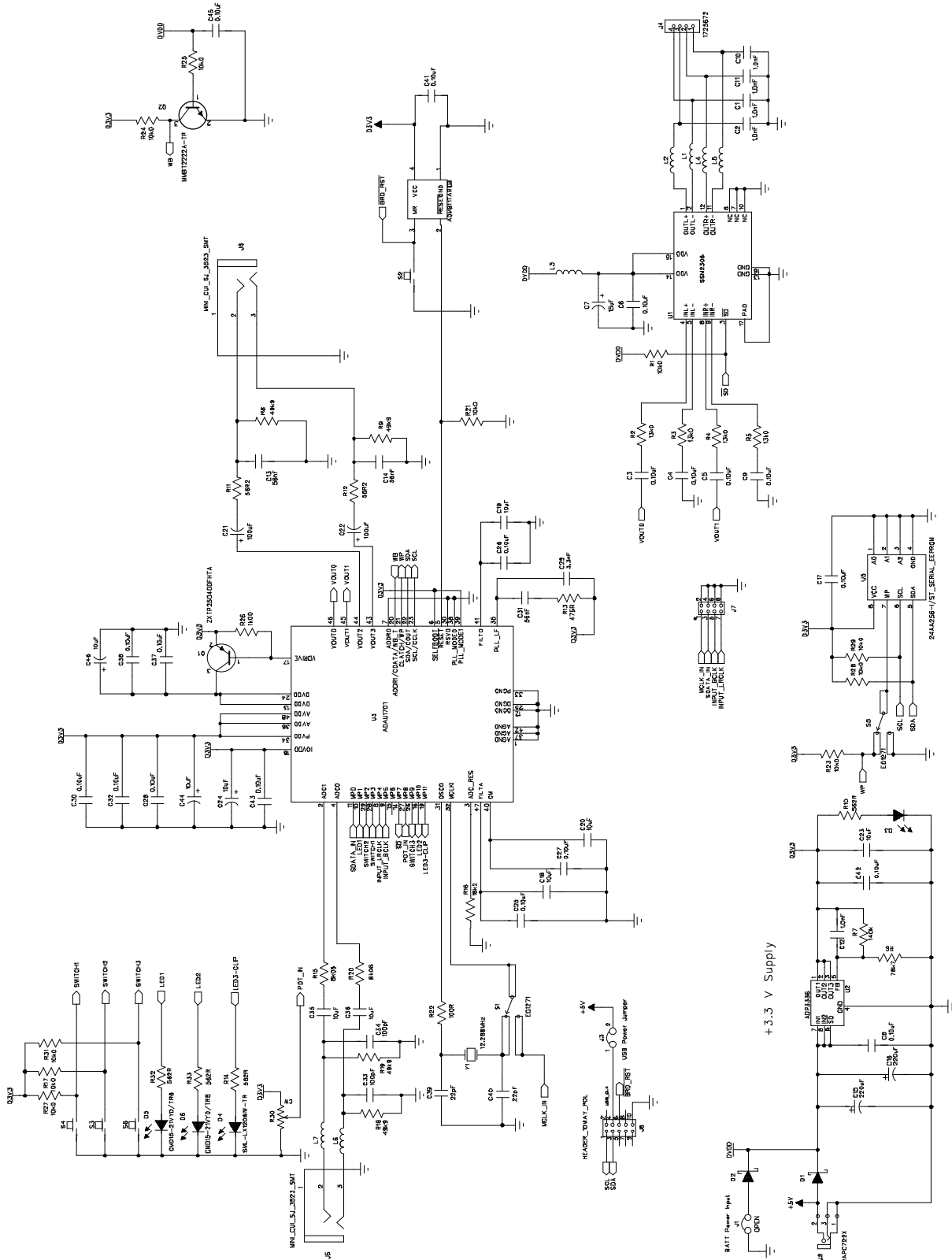

Figure 14. Board Schematics

BOARD SILKSCREEN AND PARTS PLACEMENT

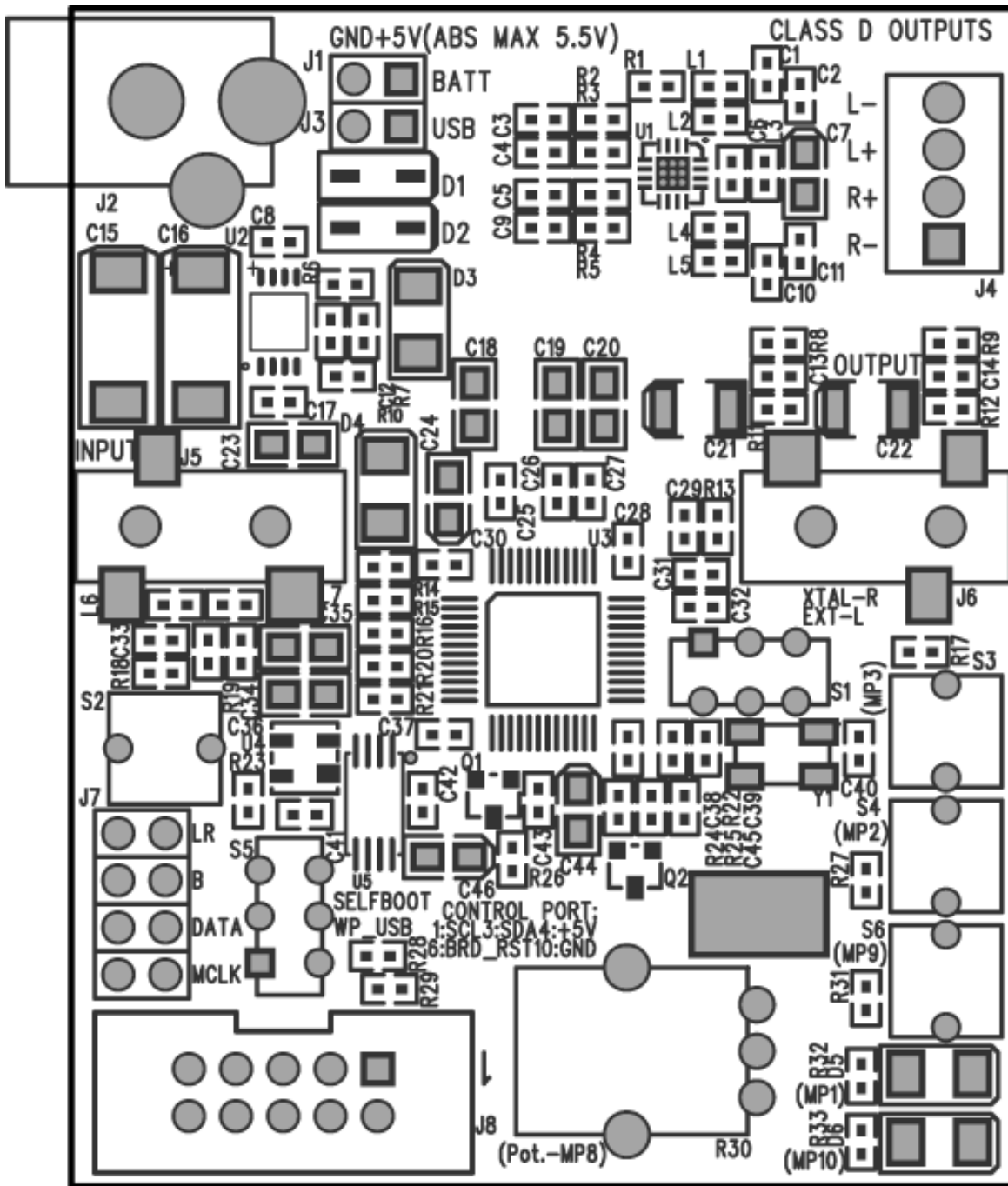

Figure 15. Board Layout

0806-028

EVAL-ADAU1701MINIZ

ORDERING INFORMATION

BILL OF MATERIALS

Table 5.

Item	Qty	Reference Designator	Description	Manufacturer	Part Number
1	5	C1, C2, C10, C11, C12	Multilayer ceramic 50 V, NP0 (0402), 1.0 nF	Murata ENA	GRM1555C1H102JA01D
2	3	C13, C14, C31	Multilayer ceramic 16 V, X7R (0402), 56 nF	Kemet	C0402C563K4RACTU
3	2	C15, C16	SMD tantalum capacitor SMD, N 6.3 V, 220 μ F	Nichicon	F930J227MNC
4	6	C18, C19, C20, C23, C35, C36	Multilayer ceramic 10 V, X7R (0805), 10 μ F	Murata ENA	GRM21BR71A106KE51L
5	2	C21, C22	Tantalum capacitor 105° SMD, 100 μ F	Kemet	T520B107M004ATE035
6	3	C24, C44, C46	SMD tantalum capacitor 6.3 V, (0805), 10 μ F	Rohm	TCP0J106M8R
7	1	C29	Multilayer ceramic 50 V, X7R (0402), 3.3 nF	Panasonic EC	ECJ-0EB1H332K
8	2	C33, C34	Multilayer ceramic 50 V, NP0 (0402), 100 pF	Murata ENA	GCM1555C1H101JZ13D
9	19	C3, C4, C5, C6, C8, C9, C17, C25, C26, C27, C28, C30, C32, C37, C38, C41, C42, C43, C45	Multilayer ceramic 16 V, X7R (0402), 0.10 μ F	Panasonic EC	ECJ-0EX1C104K
10	2	C39, C40	Multilayer ceramic 50 V, NP0 (0402), 22 pF	Murata ENC	GRM1555C1H220JZ01D
11	1	C7	SMD tantalum capacitor 6.3 V, (0805), 15 μ F	Rohm	TCP0J156M8R
12	2	D1, D2	Schottky 30 V, 0.5 A, SOD123 diode	On Semiconductor	MBR0530T1G
13	1	D3	Green diffused 10 mcd, 565 nm (1206)	Lumex Opto	SML-LX1206GW-TR
14	1	D4	Red diffused 6.0 mcd, 635 nm (1206)	Lumex Opto	SML-LX1206IW-TR
15	2	D5, D6	Yellow diffused 4.0 mcd, 585 nm 1206	CML Innovative Tech	CMD15-21VYD/TR8
16	1	J1	Not populated (open)		
17	1	J2	Mini power jack 0.08" R/A TH	Switchcraft, Inc.	RAPC722X
18	1	J3	2-pin header unshrouded jumper 0.10"; use shunt Tyco 881545-2	Sullins Electronics Corp.	PBC02SAAN
19	1	J4	Connector terminal block, 2.54 mm, 4 position, 20 - 26 awg screw clamp	Phoenix Contact	1725672
20	2	J5, J6	Stereo mini jack, SMT	CUI, Inc.	SJ-3523-SMT
21	1	J7	8-way, unshrouded header, dual row, 2 x 4	Sullins Electronics Corp	PBC04DAAN
22	1	J8	10-way, shroud polarized header, 2 x 5	3M	N2510-6002RB
23	7	L1 to L7	Chip ferrite bead 600 Ω @ 100 MHz	TDK Corp.	MMZ1005S601C
24	1	Q1	PNP transistor, 40 V, 3 A, SOT-23	Zetex, Inc.	ZXTP25040DFHTA
25	1	Q2	NPN transistor, GP, 40 V, SOT-23	Micro Commercial Co.	MMBT2222A-TP

Item	Qty	Reference Designator	Description	Manufacturer	Part Number
26	10	R1, R17, R21, R23, R24, 25, R27, R28, R29, R31	Chip resistor 1%, 63 mW, thick film (0402), 10.0 kΩ	Rohm	MCR01MZPF1002
27	4	R10, R14, R32, R33	Chip resistor 1%, 63 mW, thick film (0402), 562 Ω	Vishay/Dale	CRCW0402562RFKED
28	2	R11, R12	Chip resistor 1%, 63 mW, thick film (0402), 56.2 Ω	Vishay/Dale	CRCW040256R2FKED
29	1	R13	Chip resistor 1%, 63 mW, thick film (0402), 475 Ω	Vishay/Dale	CRCW0402475RFKED
30	2	R15, R20	Chip resistor 1%, 63 mW, thick film (0402), 8.06 Ω	Rohm	CRCW04028K06FKED
31	1	R16	Chip resistor 1%, 63 mW, thick film (0402), 18.2 kΩ	Vishay/Dale	CRCW040218K2FKED
32	1	R22	Chip resistor 1%, 63 mW, thick film (0402), 100 Ω	Rohm	MCR01MZPF1000
33	4	R2, R3, R4, R5	Chip resistor 1%, 63mW, thick film (0402), 13.0 kΩ	Rohm	MCR01MZPF1302
34	1	R26	Chip resistor 1%, 63mW, thick film (0402), 1.00 kΩ	Panasonic ECG	ERJ-2RKF1001X
35	1	R30	20.0 kΩ potentiometer, 9 mm vertical	Panasonic ECG	EVU-F2MFL3B24
36	1	R6	Chip resistor 1%, 63 mW, thick film (0402), 78.7 kΩ	Vishay/Dale	CRCW040278R7FKED
37	1	R7	Chip resistor 1%, 63 mW, thick film (0402), 140 kΩ	Panasonic ECG	ERJ-2RKF1403X
38	4	R8, R9, R18, R19	Chip resistor 1%, 63 mW, thick film (0402), 49.9 kΩ	Vishay/Dale	CRCW040249K9FKED
39	2	S1, S5	SPDT slide switch PC mount	E-Switch	EG1271
40	4	S2, S3, S4, S6	Tact switch long stroke (normally open)	Omron Electronics	B3M-6009
41	1	U1	2 W, filterless Class-D, stereo audio amplifier	Analog Devices	SSM2306CPZ
42	1	U2	Adjustable low dropout voltage regulator	Analog Devices	ADP3336ARMZ-REEL7
43	1	U3	SigmaDSP 28-/56-bit, audio processor with 2 ADC/4 DAC	Analog Devices	ADAU1701JSTZ
44	1	U4	μP voltage supervisor, logic low reset output	Analog Devices	ADM811TARTZ-REEL7
45	1	U5	256 K I ² C™ CMOS serial EEPROM	Microchip	24AA256-I/ST
46	1	Y1	Crystal 12.288 MHz SMT, 18 pF	Abracon Corp	ABM3B-12.288MHZ-10-1-U-T

EVAL-ADAU1701MINIZ

ORDERING GUIDE

Model	Description
EVAL-ADAU1701MINIZ ¹	Evaluation Board

¹ Z = RoHS Compliant Part.

ESD CAUTION



ESD (electrostatic discharge) sensitive device. Charged devices and circuit boards can discharge without detection. Although this product features patented or proprietary protection circuitry, damage may occur on devices subjected to high energy ESD. Therefore, proper ESD precautions should be taken to avoid performance degradation or loss of functionality.

Purchase of licensed I²C components of Analog Devices or one of its sublicensed Associated Companies conveys a license for the purchaser under the Philips I²C Patent Rights to use these components in an I²C system, provided that the system conforms to the I²C Standard Specification as defined by Philips.

Looking for pricing, stock, or lifecycle information?

Click below to explore more details on WIN SOURCE:

- ⊖ [View EVAL-ADAU1701MINIZ on WIN SOURCE](#)
- ⊖ [Analog Devices Inc. Information](#)

Optimize Your Supply Chain with WIN SOURCE Solutions

- ✓ Global Sourcing Solution
- ✓ Obsolete Management
- ✓ Cost Control Management
- ✓ Shortage Management
- ✓ Alternative Solution
- ✓ Excess Inventory Management