



**THE DATASHEET OF  
LTM4613IY**



# EN55022B Compliant 36V<sub>IN</sub>, 15V<sub>OUT</sub>, 8A, DC/DC $\mu$ Module Regulator

## FEATURES

- Complete Low EMI Switch Mode Power Supply
- EN55022 Class B Compliant
- Wide Input Voltage Range: 5V to 36V
- 8A Output Current
- 3.3V to 15V Output Voltage Range
- Low Input and Output Referred Noise
- Output Voltage Tracking and Margining
- PLL Frequency Synchronization
- 2% Maximum Total DC Error
- Power Good Tracks with Margining
- Current Foldback Protection
- Parallel/Current Sharing
- Ultrafast Transient Response
- Current Mode Control
- Programmable Soft-Start
- Output Overvoltage Protection
- -55°C to 125°C Operating Temperature Range (LTM4613MPV, LTM4613MPY)
- 15mm × 15mm × 4.32mm LGA and 15mm × 15mm × 4.92mm BGA Packages
- SnPb (BGA) or RoHS Compliant (LGA and BGA) Finish

## APPLICATIONS

- Telecom and Networking Equipment
- Industrial and Avionic Equipment
- RF Systems

## DESCRIPTION

The **LTM<sup>®</sup>4613** is a complete, ultralow noise, 8A switch mode DC/DC power supply. Included in the package are the switching controller, power FETs, inductor and all support components. Operating over an input voltage range of 5V to 36V, the LTM4613 supports an output voltage range of 3.3V to 15V, set by a single external resistor. Only bulk input and output capacitors are needed to finish the design.

High switching frequency and an adaptive on-time current mode architecture enables a very fast transient response to line and load changes without sacrificing stability.

The onboard input filter and noise cancellation circuits achieve low noise coupling, thus effectively reducing the electromagnetic interference (EMI)—see Figure 7. Furthermore, the DC/DC  $\mu$ Module<sup>®</sup> regulator can be synchronized with an external clock to reduce undesirable frequency harmonics and allow PolyPhase<sup>®</sup> operation for high load currents.

The LTM4613 is offered in 15mm × 15mm × 4.32mm LGA and 15mm × 15mm × 4.92mm BGA packages. The LTM4613 is available with SnPb (BGA) or RoHS compliant terminal finish.

LT, LT, LTC, LTM,  $\mu$ Module, PolyPhase, Linear Technology, and the Linear logo are registered trademarks and LTpowerCAD is a trademark of Linear Technology Corporation. All other trademarks are the property of their respective owners.

## TYPICAL APPLICATION

12V/8A Ultralow Noise  $\mu$ Module with 24V to 36V Input

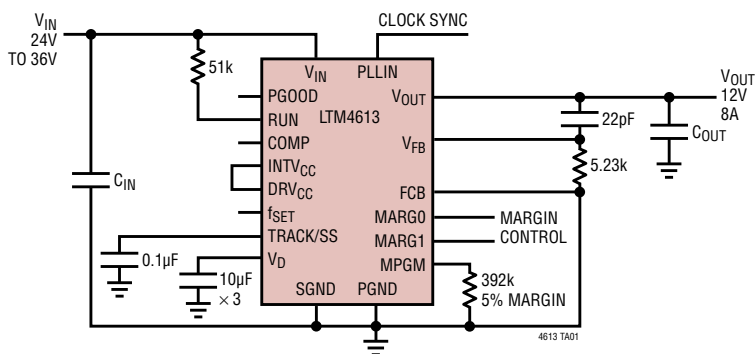

Radiated Emission Scan with 24V<sub>IN</sub> to 12V<sub>OUT</sub> at 8A

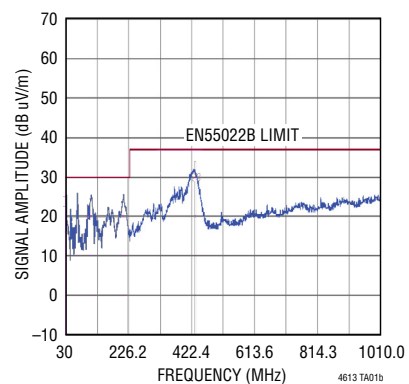

# LTM4613

## ABSOLUTE MAXIMUM RATINGS

(Note 1)

INTV<sub>CC</sub>, DRV<sub>CC</sub> ..... -0.3V to 6V  
 V<sub>OUT</sub> ..... -0.3V to 16V  
 PLLIN, FCB, TRACK/SS, MPGM, MARG0,  
 MARG1, PGOOD ..... -0.3V to INTV<sub>CC</sub> + 0.3V  
 RUN ..... -0.3V to 5V  
 V<sub>FB</sub>, COMP ..... -0.3V to 2.7V

V<sub>IN</sub>, V<sub>D</sub> ..... -0.3V to 36V  
 Internal Operating Temperature Range (Note 2)  
 E- and I-Grades ..... -40°C to 125°C  
 MP-Grade ..... -55°C to 125°C  
 Storage Temperature Range ..... -55°C to 125°C  
 Peak Solder Reflow Package Body Temperature ..... 245°C

## PIN CONFIGURATION

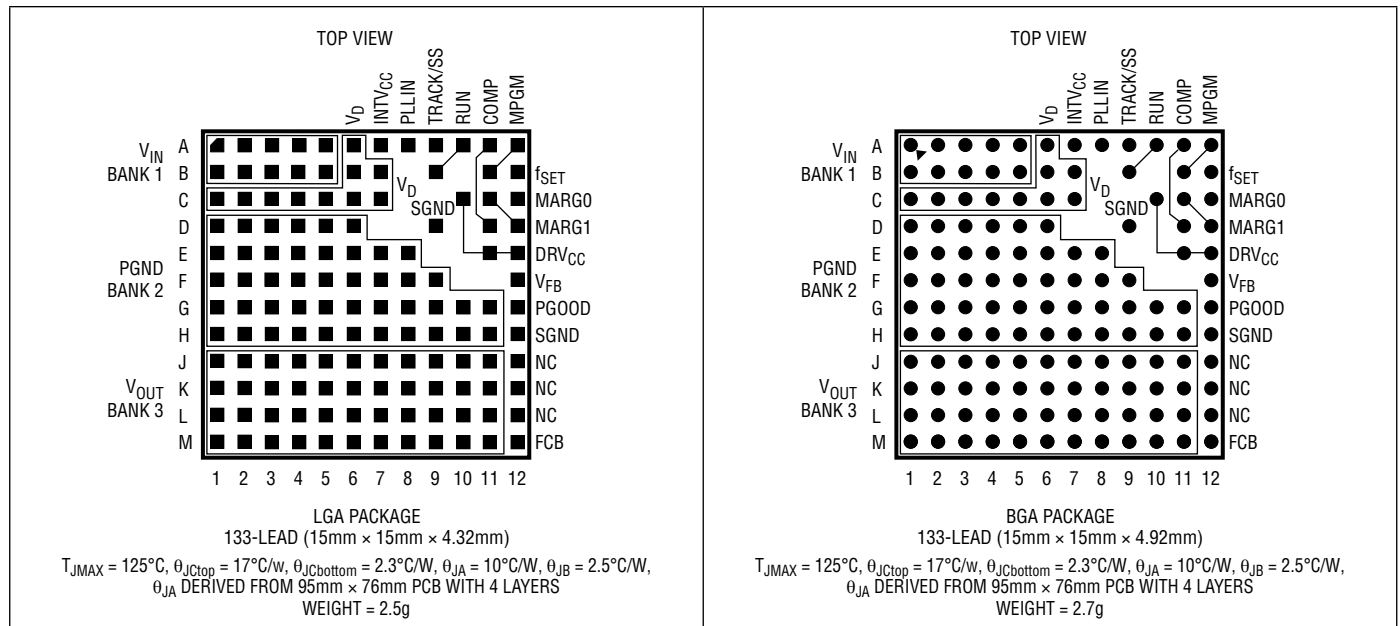

## ORDER INFORMATION <http://www.linear.com/product/LTM4613#orderinfo>

PART NUMBER	PAD OR BALL FINISH	PART MARKING*		PACKAGE TYPE	MSL RATING	TEMPERATURE RANGE (Note 2)
		DEVICE	FINISH CODE			
LTM4613EV#PBF	Au (RoHS)	LTM4613V	e4	LGA	3	-40°C to 125°C
LTM4613IV#PBF	Au (RoHS)	LTM4613V	e4	LGA	3	-40°C to 125°C
LTM4613MPV#PBF	Au (RoHS)	LTM4613V	e4	LGA	3	-55°C to 125°C
LTM4613EY#PBF	SAC305 (RoHS)	LTM4613Y	e1	BGA	3	-40°C to 125°C
LTM4613IY#PBF	SAC305 (RoHS)	LTM4613Y	e1	BGA	3	-40°C to 125°C
LTM4613IY	SnPb (63/37)	LTM4613Y	e0	BGA	3	-40°C to 125°C
LTM4613MPY#PBF	SAC305 (RoHS)	LTM4613Y	e1	BGA	3	-55°C to 125°C
LTM4613MPY	SnPb (63/37)	LTM4613Y	e0	BGA	3	-55°C to 125°C

- Consult Marketing for parts specified with wider operating temperature ranges. \*Device temperature grade is indicated by a label on the shipping container. Pad or ball finish code is per IPC/JEDEC J-STD-609.
- Terminal Finish Part Marking: [www.linear.com/leadfree](http://www.linear.com/leadfree)
- Recommended LGA and BGA PCB Assembly and Manufacturing Procedures: [www.linear.com/umodule/pcbassembly](http://www.linear.com/umodule/pcbassembly)
- LGA and BGA Package and Tray Drawings: [www.linear.com/packaging](http://www.linear.com/packaging)

**ELECTRICAL CHARACTERISTICS** The ● denotes the specifications which apply over the full internal operating temperature range, otherwise specifications are at  $T_A = 25^\circ\text{C}$  (Note 2),  $V_{IN} = 24\text{V}$ , unless otherwise noted. Per Typical Application (front page) configuration.

SYMBOL	PARAMETER	CONDITIONS	MIN	TYP	MAX	UNITS	
$V_{IN(DC)}$	Input DC Voltage		●	5	36	V	
$V_{OUT(DC)}$	Output Voltage, Total Variation with Line and Load	$C_{IN} = 10\mu\text{F} \times 3$ , $C_{OUT} = 47\mu\text{F} \times 4$ ; $\text{FCB} = 0$ , $V_{IN} = 24\text{V}$ to $36\text{V}$ , $V_{OUT} = 12\text{V}$	●	11.83	12.07	12.31	V
<b>Input Specifications</b>							
$V_{IN(UVLO)}$	Undervoltage Lockout Threshold	$I_{OUT} = 0\text{A}$		3.2	4.8	V	
$I_{INRUSH(VIN)}$	Input Inrush Current at Start-Up	$I_{OUT} = 0\text{A}$ ; $C_{IN} = 10\mu\text{F} \times 3$ , $C_{OUT} = 47\mu\text{F} \times 4$ ; $C_{SS} = 22\text{nF}$ $V_{OUT} = 12\text{V}$ $V_{IN} = 24\text{V}$ $V_{IN} = 36\text{V}$		150 120		mA mA	
$I_{Q(VIN)}$	Input Supply Bias Current	$V_{IN} = 36\text{V}$ , $V_{OUT} = 12\text{V}$ , Switching Continuous, $I_{OUT} = 0\text{A}$ $V_{IN} = 24\text{V}$ , $V_{OUT} = 12\text{V}$ , Switching Continuous, $I_{OUT} = 0\text{A}$ Shutdown, $\text{RUN} = 0$ , $V_{IN} = 36\text{V}$		78 60 50		mA mA $\mu\text{A}$	
$I_S(VIN)$	Input Supply Current	$V_{IN} = 36\text{V}$ , $V_{OUT} = 12\text{V}$ , $I_{OUT} = 8\text{A}$ $V_{IN} = 24\text{V}$ , $V_{OUT} = 12\text{V}$ , $I_{OUT} = 8\text{A}$		2.90 4.26		A A	
$V_{INTVCC}$	Internal $V_{CC}$ Voltage	$V_{IN} = 36\text{V}$ , $\text{RUN} > 2\text{V}$ , $I_{OUT} = 0\text{A}$		4.7	5	5.5	V
<b>Output Specifications</b>							
$I_{OUT(DC)}$	Output Continuous Current Range	$V_{IN} = 24\text{V}$ , $V_{OUT} = 12\text{V}$ (Note 4)		0	8	A	
$\frac{\Delta V_{OUT(LINE)}}{V_{OUT}}$	Line Regulation Accuracy	$V_{OUT} = 12\text{V}$ , $\text{FCB} = 0\text{V}$ , $V_{IN} = 24\text{V}$ to $36\text{V}$ , $I_{OUT} = 0\text{A}$	●	0.05	0.3	%	
$\frac{\Delta V_{OUT(LOAD)}}{V_{OUT}}$	Load Regulation Accuracy	$V_{OUT} = 12\text{V}$ , $\text{FCB} = 0\text{V}$ , $I_{OUT} = 0\text{A}$ to $8\text{A}$ (Note 4) $V_{IN} = 36\text{V}$ $V_{IN} = 24\text{V}$	● ●	0.5 0.5	0.75 0.75	% %	
$V_{IN(AC)}$	Input Ripple Voltage	$I_{OUT} = 0\text{A}$ , $C_{IN} = 1 \times 10\mu\text{F}$ X5R Ceramic and $1 \times 100\mu\text{F}$ Electrolytic, $3 \times 10\mu\text{F}$ X5R Ceramic on $V_D$ Pins $V_{IN} = 24\text{V}$ , $V_{OUT} = 12\text{V}$ (Note 5)		10		mV <sub>P-P</sub>	
$V_{OUT(AC)}$	Output Ripple Voltage	$I_{OUT} = 0\text{A}$ , $C_{OUT} = 1 \times 10\mu\text{F}$ , $4 \times 47\mu\text{F}$ X5R Ceramic $V_{IN} = 24\text{V}$ , $V_{OUT} = 12\text{V}$		19		mV <sub>P-P</sub>	
$f_S$	Output Ripple Voltage Frequency	$V_{IN} = 24\text{V}$ , $V_{OUT} = 12\text{V}$ , $I_{OUT} = 0\text{A}$		600		kHz	
$\Delta V_{OUT(START)}$	Turn-On Overshoot	$C_{OUT} = 47\mu\text{F} \times 4$ , $V_{OUT} = 12\text{V}$ , $I_{OUT} = 0\text{A}$ , $C_{SS} = 22\text{nF}$ $V_{IN} = 36\text{V}$ $V_{IN} = 24\text{V}$		20 20		mV mV	
$t_{START}$	Turn-On Time	$C_{OUT} = 47\mu\text{F} \times 4$ , $V_{OUT} = 12\text{V}$ , $I_{OUT} = 0\text{A}$ , $C_{SS} = \text{Open}$ $V_{IN} = 36\text{V}$ $V_{IN} = 24\text{V}$		0.3 0.3		ms ms	
$\Delta V_{OUT(LS)}$	Peak Deviation for Dynamic Load	Load: 0% to 50% to 0% of Full Load $C_{OUT} = 1 \times 10\mu\text{F}$ , $3 \times 47\mu\text{F}$ X5R Ceramic, $1 \times 47\mu\text{F}$ POSCAP $V_{IN} = 24\text{V}$ , $V_{OUT} = 12\text{V}$		250		mV	
$t_{SETTLE}$	Settling Time for Dynamic Load Step	Load: 0% to 50% to 0% of Full Load $C_{OUT} = 1 \times 10\mu\text{F}$ , $3 \times 47\mu\text{F}$ X5R Ceramic, $1 \times 47\mu\text{F}$ POSCAP $V_{IN} = 24\text{V}$ , $V_{OUT} = 12\text{V}$		100		$\mu\text{s}$	
$I_{OUT(PK)}$	Output Current Limit	$C_{OUT} = 47\mu\text{F} \times 4$ $V_{IN} = 36\text{V}$ , $V_{OUT} = 12\text{V}$ $V_{IN} = 24\text{V}$ , $V_{OUT} = 12\text{V}$		12 12		A A	

## ELECTRICAL CHARACTERISTICS

The ● denotes the specifications which apply over the full internal operating temperature range, otherwise specifications are at  $T_A = 25^\circ\text{C}$  (Note 2),  $V_{IN} = 24\text{V}$ , unless otherwise noted. Per Typical Application (front page) configuration.

SYMBOL	PARAMETER	CONDITIONS	MIN	TYP	MAX	UNITS
<b>Control Section</b>						
$V_{FB}$	Voltage at $V_{FB}$ Pin	$I_{OUT} = 0\text{A}$ , $V_{OUT} = 12\text{V}$	● 0.591	0.6	0.609	V
$V_{RUN}$	RUN Pin On/Off Threshold		1	1.5	1.9	V
$I_{TRACK/SS}$	Soft-Start Charging Current	$V_{TRACK/SS} = 0\text{V}$	-1	-1.5	-2	$\mu\text{A}$
$V_{FCB}$	Forced Continuous Threshold		0.57	0.6	0.63	V
$I_{FCB}$	Forced Continuous Pin Current	$V_{FCB} = 0\text{V}$		-1	-2	$\mu\text{A}$
$t_{ON(MIN)}$	Minimum On-Time	(Note 3)		50	100	ns
$t_{OFF(MIN)}$	Minimum Off-Time	(Note 3)		250	400	ns
$R_{PLLIN}$	PLLIN Input Resistor			50		$\text{k}\Omega$
$I_{DRVCC}$	Current into $DRV_{CC}$ Pin	$V_{OUT} = 12\text{V}$ , $I_{OUT} = 0\text{A}$ , $DRV_{CC} = 5\text{V}$		22	30	mA
$R_{FBHI}$	Resistor Between $V_{OUT}$ and $V_{FB}$ Pins		99.5	100	100.5	$\text{k}\Omega$
$V_{MPGM}$	Margin Reference Voltage			1.18		V
$V_{MARG0}$ , $V_{MARG1}$	MARG0, MARG1 Voltage Thresholds			1.4		V
<b>PGOOD</b>						
$\Delta V_{FBH}$	PGOOD Upper Threshold	$V_{FB}$ Rising	7	10	13	%
$\Delta V_{FBL}$	PGOOD Lower Threshold	$V_{FB}$ Falling	-7	-10	-13	%
$\Delta V_{FB(HYS)}$	PGOOD Hysteresis	$V_{FB}$ Returning		1.5		%
$V_{PGL}$	PGOOD Low Voltage	$I_{PGOOD} = 5\text{mA}$		0.2	0.4	V

**Note 1:** Stresses beyond those listed under Absolute Maximum Ratings may cause permanent damage to the device. Exposure to any Absolute Maximum Rating condition for extended periods may affect device reliability and lifetime.

**Note 2:** The LTM4613 is tested under pulsed load conditions such that  $T_J \approx T_A$ . The LTM4613E is guaranteed to meet performance specifications over the  $0^\circ\text{C}$  to  $125^\circ\text{C}$  internal operating temperature range. Specifications over the  $-40^\circ\text{C}$  to  $125^\circ\text{C}$  internal operating temperature range are assured by design, characterization and correlation with statistical process controls. The LTM4613I is guaranteed to meet specifications over the  $-40^\circ\text{C}$  to  $125^\circ\text{C}$  internal operating temperature range. The LTM4613MP

is guaranteed and tested over the full  $-55^\circ\text{C}$  to  $125^\circ\text{C}$  internal operating temperature range. Note that the maximum ambient temperature consistent with these specifications is determined by specific operating conditions in conjunction with board layout, the rated package thermal resistance and other environmental factors.

**Note 3:** 100% tested at die level only.

**Note 4:** See the Output Current Derating curves for different  $V_{IN}$ ,  $V_{OUT}$  and  $T_A$ .

**Note 5:** Guaranteed by design.

**TYPICAL PERFORMANCE CHARACTERISTICS** (Refer to Figure 18)

**Efficiency vs Load Current with 3.3V<sub>OUT</sub> (FCB = 0)**

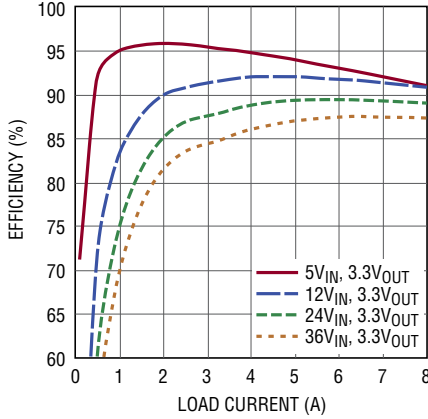

4613 G01

**Efficiency vs Load Current with 5V<sub>OUT</sub> (FCB = 0)**

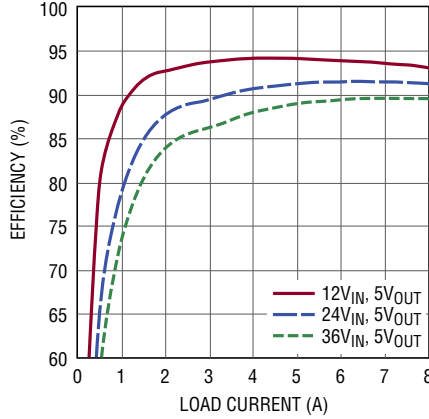

4613 G02

**Efficiency vs Load Current with 12V<sub>OUT</sub> (FCB = 0)**

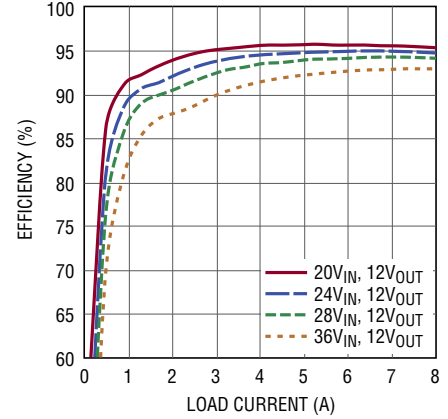

4613 G03

**Efficiency vs Load Current with 15V<sub>OUT</sub> (FCB = 0)**

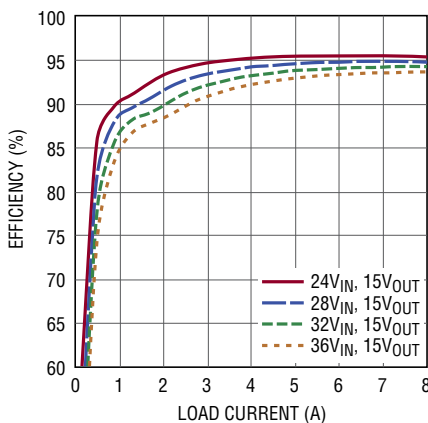

4613 G04

**Transient Response from 12V<sub>IN</sub> to 3.3V<sub>OUT</sub>**

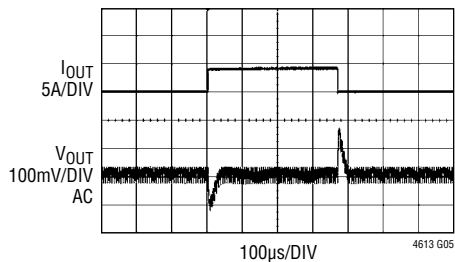

4613 G05

LOAD STEP: 0A TO 4A  
C<sub>OUT</sub> = 1 × 47μF POSCAP  
1 × 10μF CERAMIC CAPACITOR AND  
3 × 47μF CERAMIC CAPACITORS

**Transient Response from 12V<sub>IN</sub> to 5V<sub>OUT</sub>**

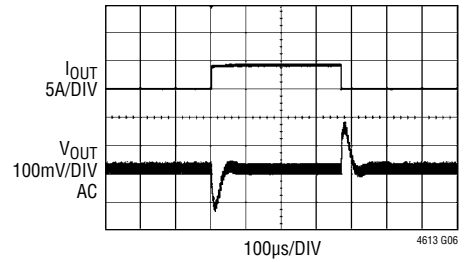

4613 G06

LOAD STEP: 0A TO 4A  
C<sub>OUT</sub> = 1 × 47μF POSCAP  
1 × 10μF CERAMIC CAPACITOR AND  
3 × 47μF CERAMIC CAPACITORS

**Transient Response from 24V<sub>IN</sub> to 12V<sub>OUT</sub>**

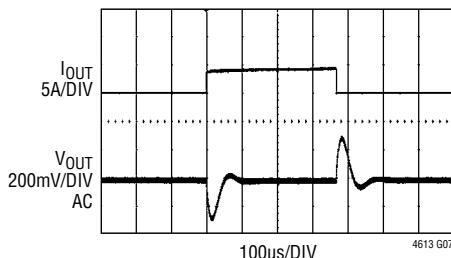

4613 G07

LOAD STEP: 0A TO 4A  
C<sub>OUT</sub> = 1 × 47μF POSCAP  
1 × 10μF CERAMIC CAPACITOR AND  
3 × 47μF CERAMIC CAPACITORS

**Start-Up with 24V<sub>IN</sub> to 12V<sub>OUT</sub> at I<sub>OUT</sub> = 0A**

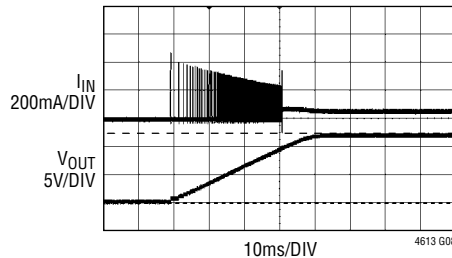

4613 G08

SOFT-START CAPACITOR: 0.1μF  
C<sub>IN</sub> = 2 × 10μF CERAMIC CAPACITORS AND  
1 × 100μF OS-CON CAPACITOR

**Start-Up with 24V<sub>IN</sub> to 12V<sub>OUT</sub> at I<sub>OUT</sub> = 8A**

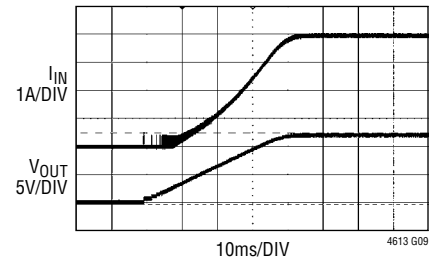

4613 G09

SOFT-START CAPACITOR: 0.1μF  
C<sub>IN</sub> = 2 × 10μF CERAMIC CAPACITORS AND  
1 × 100μF OS-CON CAPACITOR

## TYPICAL PERFORMANCE CHARACTERISTICS

**Start-Up with 24V<sub>IN</sub> to 12V<sub>OUT</sub> at I<sub>OUT</sub> = 8A, T<sub>A</sub> = -55°C**

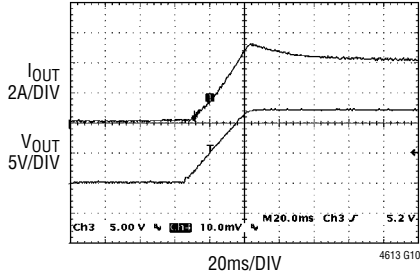

SOFT-START CAPACITOR: 0.1μF  
 C<sub>IN</sub> = 2 × 10μF CERAMIC CAPACITORS AND  
 1 × 100μF OS-CON CAPACITOR

**Short-Circuit with 24V<sub>IN</sub> to 12V<sub>OUT</sub> at I<sub>OUT</sub> = 0A**

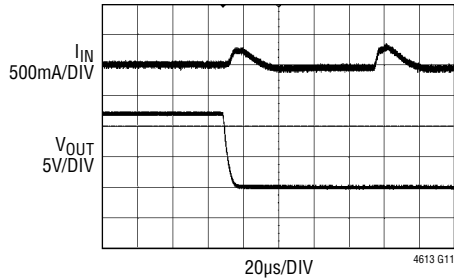

C<sub>OUT</sub> = 1 × 47μF POSCAP,  
 1 × 10μF CERAMIC CAPACITORS  
 AND 3 × 47μF CERAMIC CAPACITORS

**Short-Circuit with 24V<sub>IN</sub> to 12V<sub>OUT</sub> at I<sub>OUT</sub> = 8A**

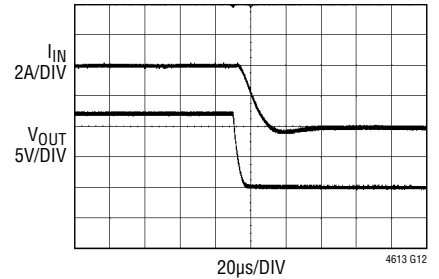

C<sub>OUT</sub> = 1 × 47μF POSCAP,  
 1 × 10μF CERAMIC CAPACITORS  
 AND 3 × 47μF CERAMIC CAPACITORS

**V<sub>IN</sub> to V<sub>OUT</sub> Step-Down Ratio**

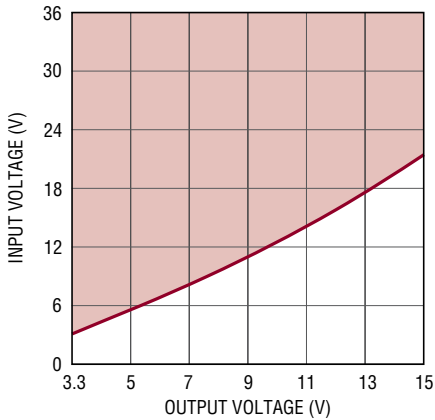

**Input Ripple**

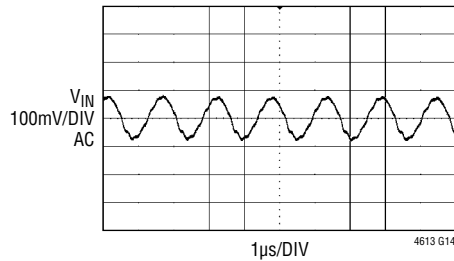

V<sub>IN</sub> = 24V  
 V<sub>OUT</sub> = 12V AT 8A RESISTIVE LOAD  
 C<sub>IN</sub> = 2 × 10μF CERAMIC CAPACITORS AND  
 1 × 100μF OS-CON CAPACITOR

**Output Ripple**

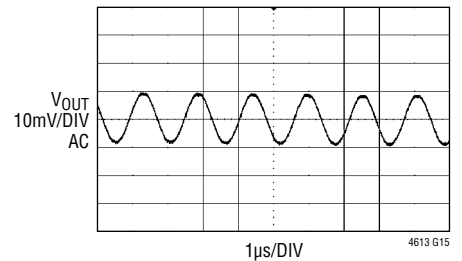

V<sub>IN</sub> = 24V  
 V<sub>OUT</sub> = 12V AT 8A RESISTIVE LOAD  
 C<sub>OUT</sub> = 1 × 47μF POSCAP  
 1 × 10μF CERAMIC CAPACITOR AND  
 3 × 47μF CERAMIC CAPACITORS

## PIN FUNCTIONS (See Package Description for Pin Assignments)

**$V_{IN}$  (Bank 1):** Power Input Pins. Apply input voltage between these pins and PGND pins. Recommend placing input decoupling capacitance directly between  $V_{IN}$  pins and PGND pins.

**PGND (Bank 2):** Power Ground Pins for Both Input and Output Returns.

**$V_{OUT}$  (Bank 3):** Power Output Pins. Apply output load between these pins and PGND pins. Recommend placing output decoupling capacitance directly between these pins and PGND pins (see the LTM4613 Pin Configuration below).

**$V_D$  (Pins C1 to C7, B6 to B7, A6):** Top FET Drain Pins. Add more high frequency ceramic decoupling capacitors between  $V_D$  and PGND to handle the input RMS current and reduce the input ripple further.

**DRV<sub>CC</sub> (Pins C10, E11, E12):** These pins normally connect to INTV<sub>CC</sub> for powering the internal MOSFET drivers. They can be biased up to 6V from an external supply with about 50mA capability. This improves efficiency at the higher input voltages by reducing power dissipation in the module. See the Applications Information section.

**INTV<sub>CC</sub> (Pin A7):** This pin is for additional decoupling of the 5V internal regulator.

**PLLIN (Pin A8):** External Clock Synchronization Input to the Phase Detector. This pin is internally terminated to SGND with a 50k resistor. Apply a clock above 2V and below INTV<sub>CC</sub> subject to minimum on-time and minimum off-time requirements. See the Applications Information section.

**FCB (Pin M12):** Forced Continuous Input. Connect this pin to SGND to force continuous synchronization operation at light load or to INTV<sub>CC</sub> to enable discontinuous mode operation at light load.

**TRACK/SS (Pin A9):** Output Voltage Tracking and Soft-Start Pin. When the module is configured as a master output, then a soft-start capacitor is placed on this pin to ground to control the master ramp rate. A soft-start capacitor can be used for soft-start turn-on as a standalone regulator. Slave operation is performed by putting a resistor divider from the master output to the ground, and connecting the center point of the divider to this pin. See the Applications Information section.

**MPGM (Pins A12, B11):** Programmable Margining Input. A resistor from these pins to ground sets a current that is equal to  $1.18V/R$ . This current multiplied by 10k will equal a value in millivolts that is a percentage of the 0.6V reference voltage. Leave floating if margining is not used. See the Applications Information section. To parallel LTM4613s, each requires an individual MPGM resistor. Do not tie MPGM pins together.

**f<sub>SET</sub> (Pin B12):** Frequency Set Internally to 600kHz at 12V Output. An external resistor can be placed from this pin to ground to increase frequency or from this pin to  $V_{IN}$  to reduce frequency. See the Applications Information section for frequency adjustment.

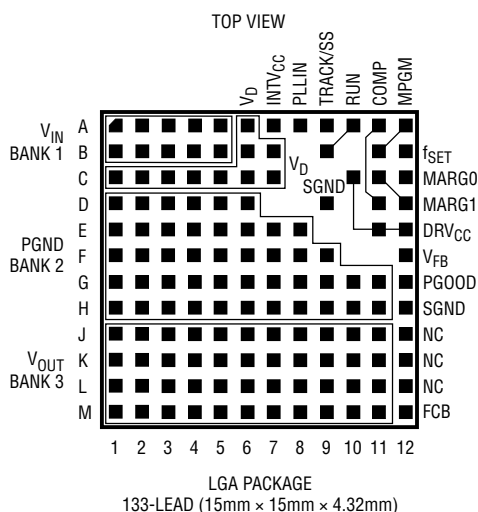

LTM4613 Pin Configuration

## PIN FUNCTIONS

**V<sub>FB</sub> (Pin F12):** The Negative Input of the Error Amplifier. Internally, this pin is connected to V<sub>OUT</sub> with a 100k 0.5% precision resistor. Different output voltages can be programmed with an additional resistor between the V<sub>FB</sub> and SGND pins. See the Applications Information section.

**MARG0 (Pin C12):** LSB Logic Input for the Margining Function. Together with the MARG1 pin, the MARG0 pin will determine if a margin high, margin low, or no margin state is applied. The pin has an internal pull-down resistor of 50k. See the Applications Information section.

**MARG1 (Pins C11, D12):** MSB Logic Input for the Margining Function. Together with the MARG0 pin, the MARG1 pin will determine if a margin high, margin low, or no margin state is applied. The pins have an internal pull-down resistor of 50k. See the Applications Information section.

**SGND (Pins D9, H12):** Signal Ground Pins. These pins connect to PGND at output capacitor point.

**COMP (Pins A11, D11):** Current Control Threshold and Error Amplifier Compensation Point. The current comparator threshold increases with this control voltage. The voltage ranges from 0V to 2.4V with 0.7V corresponding to zero sense voltage (zero current).

**PGOOD (Pin G12):** Output Voltage Power Good Indicator. Open-drain logic output that is pulled to ground when the output voltage is not within  $\pm 10\%$  of the regulation point, after a 25 $\mu$ s power bad mask timer expires.

**RUN (Pins A10, B9):** Run Control Pins. A voltage above 1.9V will turn on the module, and below 1V will turn off the module. A programmable UVLO function can be accomplished with a resistor from V<sub>IN</sub> to this pin that has a 5.1V Zener to ground. Maximum pin voltage is 5V.

**MTP (Pins J12, K12, L12):** No Connect Pins. Leave floating. Used for mounting to PCB.

# BLOCK DIAGRAM

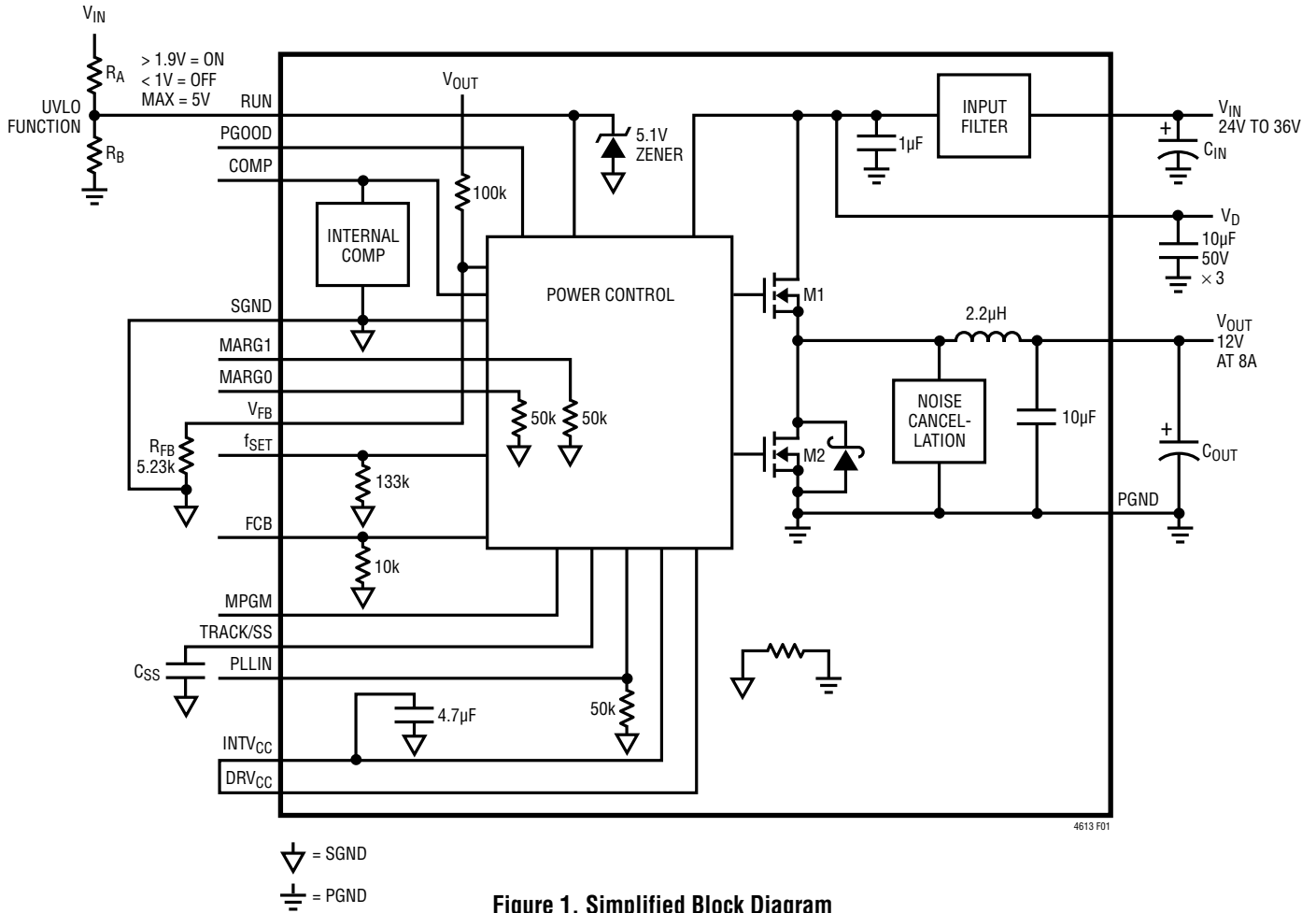

Figure 1. Simplified Block Diagram

## DECOUPLING REQUIREMENTS Specifications are at $T_A = 25^\circ\text{C}$ . Use Figure 1 configuration.

SYMBOL	PARAMETER	CONDITIONS	MIN	TYP	MAX	UNITS
$C_{IN}$	External Input Capacitor Requirement ( $V_{IN} = 24\text{V to } 36\text{V}$ , $V_{OUT} = 12\text{V}$ )	$I_{OUT} = 8\text{A}$	30	100		$\mu\text{F}$
$C_{OUT}$	External Output Capacitor Requirement ( $V_{IN} = 24\text{V to } 36\text{V}$ , $V_{OUT} = 12\text{V}$ )	$I_{OUT} = 8\text{A}$	100	220		$\mu\text{F}$

## OPERATION

### Power Module Description

The LTM4613 is a standalone nonisolated switch mode DC/DC power supply. It can deliver 8A of DC output current with minimal external input and output capacitors. This module provides a precisely regulated output voltage programmable via one external resistor from  $3.3V_{DC}$  to  $15V_{DC}$  over a wide 5V to 36V input voltage. The typical application schematic is shown in Figure 18.

The LTM4613 has an integrated constant on-time current mode regulator, ultralow  $R_{DS(ON)}$  FETs with fast switching speed and integrated Schottky diodes. The typical switching frequency is 600kHz at full load at 12V output. With current mode control and internal feedback loop compensation, the LTM4613 module has sufficient stability margins and good transient performance under a wide range of operating conditions and with a wide range of output capacitors, even all ceramic output capacitors.

Current mode control provides cycle-by-cycle fast current limiting. Moreover, foldback current limiting is provided in an overcurrent condition when  $V_{FB}$  drops. Internal overvoltage and undervoltage comparators pull the open-drain PGOOD output low if the output feedback voltage exits a  $\pm 10\%$  window around the regulation point. Furthermore, in an overvoltage condition, internal top FET M1 is turned

off and bottom FET M2 is turned on and held on until the overvoltage condition clears.

Input filter and noise cancellation circuitry reduce the noise coupling to inputs and outputs, and ensure the electromagnetic interference (EMI) meets the limits of EN55022 Class B (see Figure 7).

Pulling the RUN pin below 1V forces the controller into its shutdown state, turning off both M1 and M2. At light load currents, discontinuous mode (DCM) operation can be enabled to achieve higher efficiency compared to continuous mode (CCM) by setting FCB pin higher than 0.6V.

When the  $DRV_{CC}$  pin is connected to  $INTV_{CC}$ , an integrated 5V linear regulator powers the internal gate drivers. If a 5V external bias supply is applied on  $DRV_{CC}$  pin, then an efficiency improvement will occur due to the reduced power loss in the internal linear regulator. This is especially true at the higher input voltage range.

The MPGM, MARG0, and MARG1 pins are used to support voltage margining, where the percentage of margin is programmed by the MPGM pin, while the MARG0 and MARG1 select positive or negative margining. The PLLIN pin provides frequency synchronization of the device to an external clock. The TRACK/SS pin is used for power supply tracking and soft-start programming.

## APPLICATIONS INFORMATION

The typical LTM4613 application circuit is shown in Figure 18. External component selection is primarily determined by the input voltage, the maximum load current and the output voltage. Refer to Table 2 for specific external capacitor requirements for a particular application.

### $V_{IN}$ to $V_{OUT}$ Step-Down Ratios

There are restrictions in the maximum  $V_{IN}$  and  $V_{OUT}$  step down ratio that can be achieved for a given input voltage. These constraints are shown in the Typical Performance Characteristic curve labeled " $V_{IN}$  to  $V_{OUT}$  Step-Down Ratio." Note that additional thermal derating may be applied. See the Thermal Considerations and Output Current Derating section in this data sheet.

### Output Voltage Programming and Margining

The PWM controller has an internal 0.6V reference voltage. As shown in the Block Diagram, a 100k 0.5% internal feedback resistor connects the  $V_{OUT}$  and  $V_{FB}$  pins together. Adding a resistor,  $R_{FB}$ , from the  $V_{FB}$  pin to the SGND pin programs the output voltage.

$$V_{OUT} = 0.6V \cdot \frac{100k + R_{FB}}{R_{FB}}$$

or equivalently,

$$R_{FB} = \frac{100k}{\frac{V_{OUT}}{0.6V} - 1}$$

## APPLICATIONS INFORMATION

**Table 1. R<sub>FB</sub> Standard 1% Resistor Values vs V<sub>OUT</sub>**

V <sub>OUT</sub> (V)	3.3	5	6	8	10	12	14	15
R <sub>FB</sub> (kΩ)	22.1	13.7	11.0	8.06	6.34	5.23	4.42	4.12

The MPGM pin programs a current that when multiplied by an internal 10k resistor sets up the 0.6V reference ± offset for margining. A 1.18V reference divided by the R<sub>PGM</sub> resistor on the MPGM pin programs the current. Calculate V<sub>OUT(MARGIN)</sub>:

$$V_{OUT(MARGIN)} = \frac{\%V_{OUT}}{100} \cdot V_{OUT}$$

Where %V<sub>OUT</sub> is the percentage of V<sub>OUT</sub> to be margined, and V<sub>OUT(MARGIN)</sub> is the margin quantity in volts:

$$R_{PGM} = \frac{V_{OUT}}{0.6V} \cdot \frac{1.18V}{V_{OUT(MARGIN)}} \cdot 10k$$

Where R<sub>PGM</sub> is the resistor value to place on the MPGM pin to ground.

The margining voltage, V<sub>OUT(MARGIN)</sub>, will be added or subtracted from the nominal output voltage as determined by the state of the MARG0 and MARG1 pins. See the truth table below:

MARG1	MARG0	MODE
LOW	LOW	NO MARGIN
LOW	HIGH	MARGIN UP
HIGH	LOW	MARGIN DOWN
HIGH	HIGH	NO MARGIN

### Parallel Operation

The LTM4613 device is an inherently current mode controlled device. This allows the paralleled modules to have very good current sharing and balanced thermals on the design. Figure 21 shows a schematic of the parallel design. The voltage feedback equation changes with the variable N as modules are paralleled:

$$R_{FB} = \frac{100k}{\frac{N}{\frac{V_{OUT}}{0.6V}} - 1}$$

where N is the number of paralleled modules.

### Operating Frequency

The operating frequency of the LTM4613 is optimized to achieve the compact package size and the minimum output ripple voltage while still keeping high efficiency. As shown in Figure 2, the frequency is linearly increased with larger output voltages to keep the low output current ripple. Figure 3 shows the inductor current ripple ΔI with different output voltages. In most applications, no additional frequency adjusting is required.

If lower output ripple is required, the operating frequency f can be increased by adding a resistor R<sub>fSET</sub> between f<sub>SET</sub> pin and SGND, as shown in Figure 19.

$$f = \frac{V_{OUT}}{1.5 \cdot 10^{-10} (R_{fSET} || 133k)} \text{ [Hz]}$$

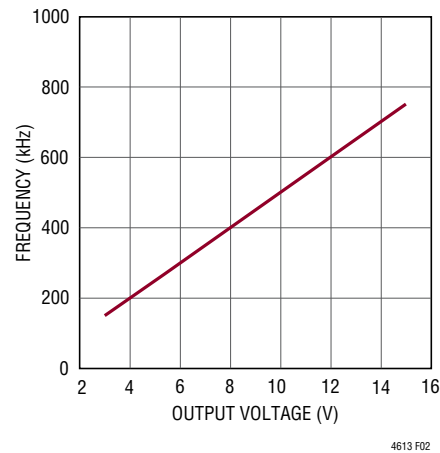

**Figure 2. Operating Frequency vs Output Voltage**

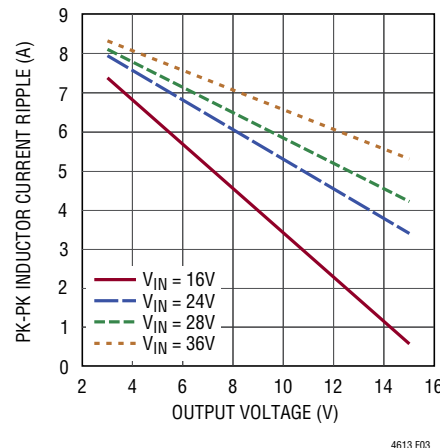

**Figure 3. Pk-Pk Inductor Current Ripple vs Output Voltage**

## APPLICATIONS INFORMATION

For output voltages more than 12V, the frequency can be higher than 600kHz, thus reducing the efficiency significantly. Additionally, the minimum off-time of 400ns normally limits the operation when the input voltage is close to the output voltage. Therefore, it is recommended to lower the frequency in these conditions by connecting a resistor ( $R_{fSET}$ ) from the  $f_{SET}$  pin to  $V_{IN}$  as shown in Figure 20, where:

$$f = \frac{V_{OUT}}{5 \cdot 10^{-11} \left( \frac{3 \cdot R_{fSET} \cdot 133k}{R_{fSET} - 2 \cdot 133k} \right)} \text{ [Hz]}$$

The load current can affect the frequency due to its constant on-time control. If constant frequency is a necessity, the PLLIN pin can be used to synchronize the frequency of the LTM4613 to an external clock subject to minimum on-time and off-time limits, as shown in Figures 21 to 23.

### Input Capacitors

LTM4613 is designed to achieve low input conducted EMI noise due to the fast switching of turn-on and turn-off. Additionally, a high-frequency inductor is integrated into the input line for noise attenuation.  $V_D$  and  $V_{IN}$  pins are available for external input capacitors to form a high frequency  $\pi$  filter. As shown in Figure 18, the ceramic capacitors, C1-C3, on the  $V_D$  pins are used to handle most of the RMS current into the converter, so careful attention is needed for capacitors C1-C3 selection.

For a buck converter, the switching duty cycle can be estimated as:

$$D = \frac{V_{OUT}}{V_{IN}}$$

Without considering the inductor current ripple, the RMS current of the input capacitor can be estimated as:

$$I_{CIN(RMS)} = \frac{I_{OUT(MAX)}}{\eta} \cdot \sqrt{D \cdot (1-D)}$$

In this equation,  $\eta$  is the estimated efficiency of the power module. Note the capacitor ripple current ratings are often based on temperature and hours of life. This makes it advisable to properly derate the input capacitor,

or choose a capacitor rated at a higher temperature than required. Always contact the capacitor manufacturer for derating requirements.

In a typical 8A output application, three very low ESR, X5R or X7R, 10 $\mu$ F ceramic capacitors are recommended for C1-C3. This decoupling capacitance should be placed directly adjacent to the module  $V_D$  pins in the PCB layout to minimize the trace inductance and high frequency AC noise. Each 10 $\mu$ F ceramic is typically good for 2A of RMS ripple current. Refer to your ceramics capacitor catalog for the RMS current ratings.

To attenuate the high frequency noise, extra input capacitors should be connected to the  $V_{IN}$  pads and placed before the high frequency inductor to form the  $\pi$  filter. One of these low ESR ceramic input capacitors is recommended to be close to the connection into the system board. A large bulk 100 $\mu$ F capacitor is only needed if the input source impedance is compromised by long inductive leads or traces.

### Output Capacitors

The LTM4613 is designed for low output voltage ripple. The bulk output capacitors defined as  $C_{OUT}$  are chosen with low enough effective series resistance (ESR) to meet the output voltage ripple and transient requirements.  $C_{OUT}$  can be low ESR tantalum capacitor, low ESR polymer capacitor or ceramic capacitor. The typical capacitance is 4  $\times$  47 $\mu$ F if all ceramic output capacitors are used. Additional output filtering may be required by the system designer if further reduction of output ripple or dynamic transient spikes is required. Table 2 shows a matrix of different output voltages and output capacitors to minimize the voltage droop and overshoot during a 4A load transient. The table optimizes total equivalent ESR and total bulk capacitance to maximize transient performance.

Multiphase operation with multiple LTM4613 devices in parallel will also lower the effective output ripple current due to the phase interleaving operation. Refer to Figure 4 for the normalized output ripple current versus the duty cycle. Figure 4 provides a ratio of peak-to-peak output ripple current to the inductor ripple current as functions of duty cycle and the number of paralleled phases. Pick the corresponding duty cycle and the number of phases to get the correct output ripple current value. For example, each

## APPLICATIONS INFORMATION

Table 2. Output Voltage Response Versus Component Matrix (Refer to Figure 19)

### TYPICAL MEASURED VALUES

VENDORS	PART NUMBER	VENDORS	PART NUMBER
Murata	GRM32ER61C476KE15L (47 $\mu$ F, 16V)	Murata	GRM32ER71H106K (10 $\mu$ F, 50V)
Murata	GRM32ER61C226KE20L (22 $\mu$ F, 16V)	TDK	C3225X5RIC226M (22 $\mu$ F, 16V)

V <sub>OUT</sub> (V)	C <sub>IN</sub> (CERAMIC)	C <sub>IN</sub> (BULK)	C <sub>OUT1</sub> (CERAMIC)	C <sub>OUT2</sub> (BULK)	V <sub>IN</sub> (V)	DROOP (mV)	PK-TO-PK (mV)	RECOVERY TIME ( $\mu$ s)	LOAD STEP (A)	LOAD STEP SLEW RATE (A/ $\mu$ S)	R <sub>FB</sub> (k $\Omega$ )
3.3	2 $\times$ 10 $\mu$ F 50V	100 $\mu$ F 50V	2 $\times$ 22 $\mu$ F 16V	150 $\mu$ F 16V	5	84	175	50	4	10	22.1
3.3	2 $\times$ 10 $\mu$ F 50V	100 $\mu$ F 50V	4 $\times$ 47 $\mu$ F 16V	None	5	91	181	40	4	10	22.1
3.3	2 $\times$ 10 $\mu$ F 50V	100 $\mu$ F 50V	2 $\times$ 22 $\mu$ F 16V	150 $\mu$ F 16V	12	100	188	50	4	10	22.1
3.3	2 $\times$ 10 $\mu$ F 50V	100 $\mu$ F 50V	4 $\times$ 47 $\mu$ F 16V	None	12	100	191	40	4	10	22.1
3.3	2 $\times$ 10 $\mu$ F 50V	100 $\mu$ F 50V	2 $\times$ 22 $\mu$ F 16V	150 $\mu$ F 16V	24	113	200	50	4	10	22.1
3.3	2 $\times$ 10 $\mu$ F 50V	100 $\mu$ F 50V	4 $\times$ 47 $\mu$ F 16V	None	24	103	197	40	4	10	22.1
5	2 $\times$ 10 $\mu$ F 50V	100 $\mu$ F 50V	2 $\times$ 22 $\mu$ F 16V	150 $\mu$ F 16V	12	109	222	60	4	10	13.7
5	2 $\times$ 10 $\mu$ F 50V	100 $\mu$ F 50V	4 $\times$ 47 $\mu$ F 16V	None	12	122	238	50	4	10	13.7
5	2 $\times$ 10 $\mu$ F 50V	100 $\mu$ F 50V	2 $\times$ 22 $\mu$ F 16V	150 $\mu$ F 16V	24	119	228	60	4	10	13.7
5	2 $\times$ 10 $\mu$ F 50V	100 $\mu$ F 50V	4 $\times$ 47 $\mu$ F 16V	None	24	122	238	50	4	10	13.7
5	2 $\times$ 10 $\mu$ F 50V	100 $\mu$ F 50V	2 $\times$ 22 $\mu$ F 16V	150 $\mu$ F 16V	36	125	231	60	4	10	13.7
5	2 $\times$ 10 $\mu$ F 50V	100 $\mu$ F 50V	4 $\times$ 47 $\mu$ F 16V	None	36	128	247	50	4	10	13.7
12	2 $\times$ 10 $\mu$ F 50V	100 $\mu$ F 50V	2 $\times$ 22 $\mu$ F 16V	150 $\mu$ F 16V	24	178	363	150	4	10	5.23
12	2 $\times$ 10 $\mu$ F 50V	100 $\mu$ F 50V	4 $\times$ 47 $\mu$ F 16V	None	24	238	488	90	4	10	5.23
12	2 $\times$ 10 $\mu$ F 50V	100 $\mu$ F 50V	2 $\times$ 22 $\mu$ F 16V	150 $\mu$ F 16V	36	181	369	150	4	10	5.23
12	2 $\times$ 10 $\mu$ F 50V	100 $\mu$ F 50V	4 $\times$ 47 $\mu$ F 16V	None	36	244	500	90	4	10	5.23

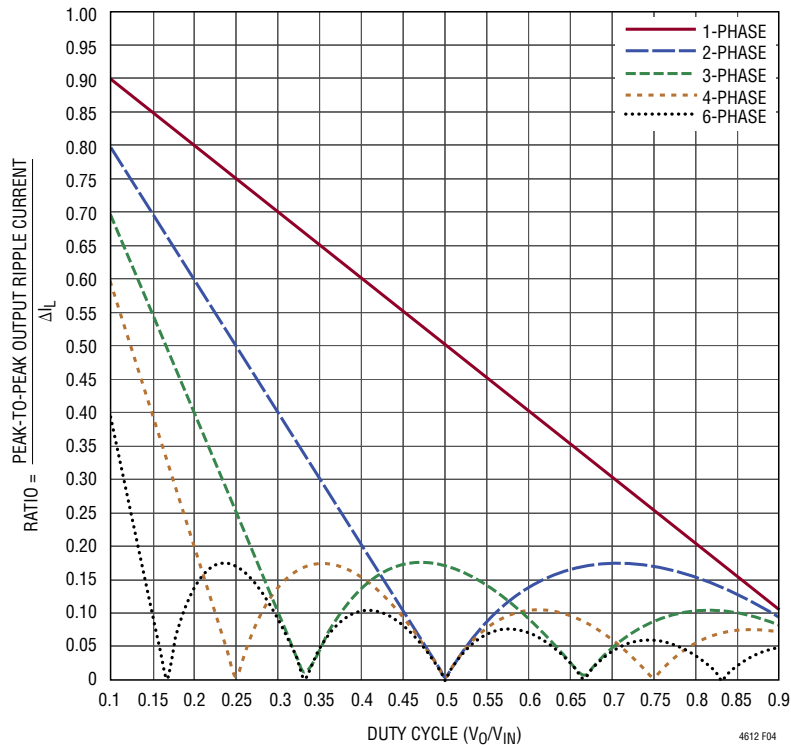

Figure 4. Normalized Output Ripple Current vs Duty Cycle,  $\Delta I_L = V_O T / L_I$

4613fd

## APPLICATIONS INFORMATION

phase's inductor ripple current  $\Delta I_L$  is  $\sim 5.0A$  for a 36V to 12V design. The duty cycle is about 0.33. The 2-phase curve shows a ratio of  $\sim 0.33$  for a duty cycle of 0.33. This 0.33 ratio of output ripple current to the inductor ripple current  $\Delta I_L$  at 5.0A equals 1.65A of output ripple current ( $\Delta I_O$ ).

The output voltage ripple has two components that are related to the amount of bulk capacitance and effective series resistance (ESR) of the output bulk capacitance. The equation is:

$$\Delta V_{OUT(P-P)} \approx \left( \frac{\Delta I_O}{8 \cdot f \cdot N \cdot C_{OUT}} \right) + \frac{ESR \cdot \Delta I_O}{N}$$

where  $f$  is the frequency and  $N$  is the number of paralleled phases. This calculation process can be easily accomplished by using LTpowerCAD™.

### Fault Conditions: Current Limit and Overcurrent Foldback

LTM4613 has a current mode controller, which inherently limits the cycle-by-cycle inductor current not only in steady state operation, but also in response to transients.

To further limit current in the event of an overload condition, the LTM4613 provides foldback current limiting. If the output voltage falls by more than 50%, then the maximum output current is progressively lowered to about one sixth of its full current limit value.

### Soft-Start and Tracking

The TRACK/SS pin provides a means to either soft-start the regulator or track it to a different power supply. A capacitor on this pin will program the ramp rate of the output voltage. A 1.5 $\mu A$  current source will charge up the external soft-start capacitor to 80% of the 0.6V internal voltage reference plus or minus any margin delta. This will control the ramp of the internal reference and the output voltage. The total soft-start time can be calculated as:

$$t_{SOFTSTART} \approx 0.8 \cdot (0.6V \pm V_{OUT(MARGIN)}) \cdot \frac{C_{SS}}{1.5\mu A}$$

If the RUN pin falls below 1.5V, then the TRACK/SS pin is reset to allow for proper soft-start control when the regulator is enabled again. Current foldback and forced continuous mode are disabled during the soft-start pro-

cess. The soft-start function can also be used to control the output ramp rise time, so that another regulator can be easily tracked to it.

### Output Voltage Tracking

Output voltage tracking can be programmed externally using the TRACK/SS pin. The output can be tracked up and down with another regulator. Figure 5 shows an example of coincident tracking where the master regulator's output is divided down with an external resistor divider that is the same as the slave regulator's feedback divider. Ratiometric modes of tracking can be achieved by selecting different resistor values to change the output tracking ratio. The master output must be greater than the slave output for coincident tracking to work. Figure 6 shows the coincident output tracking characteristics.

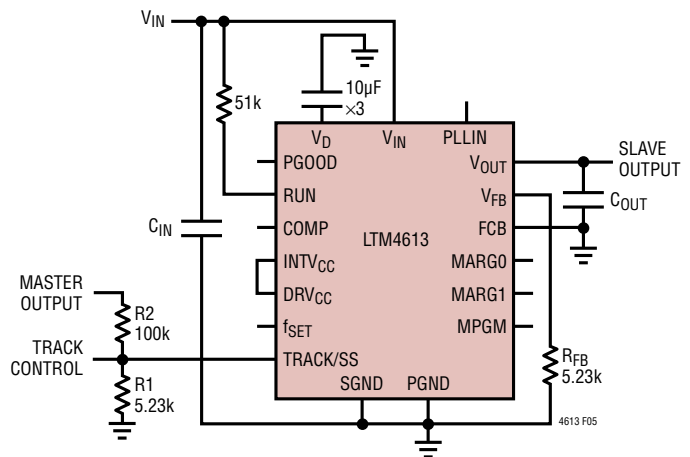

Figure 5. Coincident Tracking Schematic

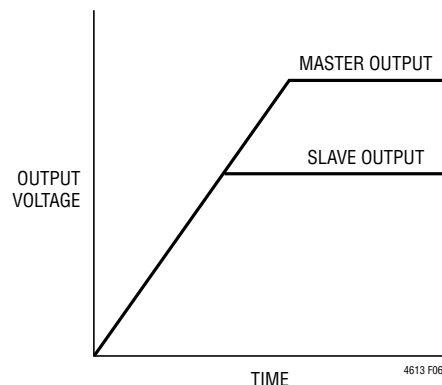

Figure 6. Coincident Output Tracking Characteristics

4613fd

## APPLICATIONS INFORMATION

Ratiometric tracking can be achieved by a few simple calculations and the slew rate value applied to the master's TRACK/SS pin. The TRACK/SS pin has a control range from 0 to 0.6V. The master's TRACK/SS pin slew rate is directly equal to the master's output slew rate in Volts/Time. The equation:

$$\frac{MR}{SR} \cdot 100k = R2$$

where MR is the master's output slew rate and SR is the slave's output slew rate in Volts/Time. When coincident tracking is desired, then MR and SR are equal, thus R2 is equal to 100k. R1 is derived from equation:

$$R1 = \frac{0.6V}{\frac{V_{FB}}{100k} + \frac{V_{FB}}{R_{FB}} - \frac{V_{TRACK}}{R2}}$$

where  $V_{FB}$  is the feedback voltage reference of the regulator, and  $V_{TRACK}$  is 0.6V. Since R2 is equal to the 100k top feedback resistor of the slave regulator in equal slew rate or coincident tracking, then R1 is equal to  $R_{FB}$  with  $V_{FB} = V_{TRACK}$ . Therefore  $R2 = 100k$ , and  $R1 = 5.23k$  in Figure 5.

In ratiometric tracking, a different slew rate maybe desired for the slave regulator. R2 can be solved for when SR is slower than MR. Make sure that the slave supply slew rate is chosen to be fast enough so that the slave output voltage will reach its final value before the master output.

For example,  $MR = 1.5V/1ms$ , and  $SR = 1.2V/1ms$ . Then  $R2 = 125k$ . Solve for R1 to equal 5.18k.

Each of the TRACK/SS pins will have the 1.5 $\mu$ A current source on when a resistive divider is used to implement tracking on that specific channel. This will impose an offset on the TRACK/SS pin input. Smaller values resistors with the same ratios as the resistor values calculated from the above equation can be used. For example, where the 100k is used then a 10k value can be used to reduce the TRACK/SS pin offset to a negligible value.

### RUN Enable

The RUN pin is used to enable the power module. The pin has an internal 5.1V Zener to ground. The pin can be driven with 5V logic levels.

The RUN pin can also be used as an undervoltage lockout (UVLO) function by connecting a resistor divider from the input supply to the RUN pin. The equation for UVLO threshold:

$$V_{UVLO} = \frac{R_A + R_B}{R_B} \cdot 1.5V$$

where  $R_A$  is the top resistor, and  $R_B$  is the bottom resistor. Refer to Figure 1, Simplified Block Diagram.

### Power Good

The PGOOD pin is an open-drain pin that can be used to monitor valid output voltage regulation. This pin monitors a  $\pm 10\%$  window around the regulation point and tracks with margining.

### COMP Pin

This pin is the external compensation pin. The module has already been internally compensated for most output voltages. LTpowerCAD is available for other control loop optimization.

### FCB Pin

The FCB pin determines whether the bottom MOSFET remains on when current reverses in the inductor. Tying this pin above its 0.6V threshold enables discontinuous operation where the bottom MOSFET turns off when inductor current reverses. FCB pin below the 0.6V threshold forces continuous synchronous operation, allowing current to reverse at light loads and maintaining high frequency operation.

### PLLIN Pin

The power module has a phase-locked loop comprised of an internal voltage controlled oscillator and a phase detector. This allows the internal top MOSFET turn-on to be locked to the rising edge of an external clock. The external clock frequency range must be within  $\pm 30\%$  around the set operating frequency. A pulse detection circuit is used to detect a clock on the PLLIN pin to turn on the phase-locked loop. The pulse width of the clock has to be at least 400ns. The clock high level must be above 2V and clock low level below 0.3V. The PLLIN pin

## APPLICATIONS INFORMATION

must be driven from a low impedance source such as a logic gate located close to the pin. During the start-up of the regulator, the phase-locked loop function is disabled.

### INTV<sub>CC</sub> and DRV<sub>CC</sub> Connection

An internal low dropout regulator produces an internal 5V supply that powers the control circuitry and DRV<sub>CC</sub> for driving the internal power MOSFETs. Therefore, if the system does not have a 5V power rail, the LTM4613 can be directly powered by V<sub>IN</sub>. The gate driver current through the LDO is about 20mA. The internal LDO power dissipation can be calculated as:

$$P_{LDO\_LOSS} = 20\text{mA} \cdot (V_{IN} - 5\text{V})$$

The LTM4613 also provides the external gate driver voltage pin DRV<sub>CC</sub>. If there is a 5V rail in the system, it is recommended to connect the DRV<sub>CC</sub> pin to the external 5V rail. This is especially true for higher input voltages. Do not apply more than 6V to the DRV<sub>CC</sub> pin.

### Radiated EMI Noise

High radiated EMI noise is a disadvantage for switching regulators by nature. Fast switching turn-on and turn-off make the large di/dt change in the converters, which act as the radiation sources in most systems. LTM4613 integrates the feature to minimize the radiated EMI noise for applications with low noise requirements. An optimized gate driver for the MOSFET and a noise cancellation

network are installed inside the LTM4613 to achieve the low radiated EMI noise. Figure 7 shows a typical example for the LTM4613 to meet the EN55022 Class B radiated emission limit.

### Thermal Considerations and Output Current Derating

In different applications, LTM4613 operates in a variety of thermal environments. The maximum output current is limited by the environment thermal condition. Sufficient cooling should be provided to help ensure reliable operation. When the cooling is limited, proper output current derating is necessary, considering ambient temperature, airflow, input/output condition, and the need for increased reliability.

The thermal resistances reported in the Pin Configuration section of the data sheet are consistent with those parameters defined by JESD51-12. They are intended for use with finite element analysis (FEA) software modeling tools that leverage the outcome of thermal modeling, simulation and correlation to hardware evaluation performed on a  $\mu$ Module package mounted to a hardware test board. The motivation for providing these thermal coefficients is found in JESD51-12, "Guidelines for Reporting and Using Electronic Package Thermal Information."

Many designers may opt to use laboratory equipment and a test vehicle, such as the demo board, to predict the  $\mu$ Module regulator's thermal performance in their

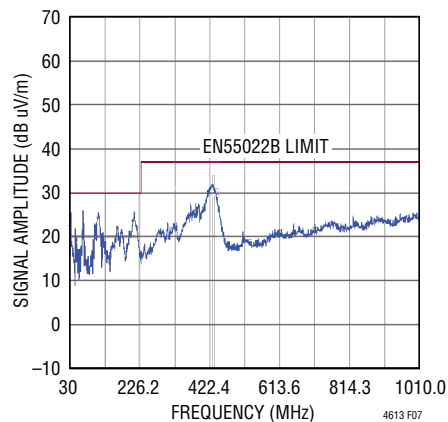

Figure 7. Radiated Emission Scan with 24V<sub>IN</sub> to 12V<sub>OUT</sub> at 8A Measured in 10 Meter Chamber

## APPLICATIONS INFORMATION

application at various electrical and environmental operating conditions to compliment any FEA activities. Without FEA software, the thermal resistances reported in the Pin Configuration section are, in and of themselves, not relevant to providing guidance of thermal performance. Instead, the derating curves provided in the data sheet can be used in a manner that yields insight and guidance pertaining to one's application-usage, and can be adapted to correlate thermal performance to one's own application.

The Pin Configuration section gives four thermal coefficients, explicitly defined in JESD51-12. These coefficients are quoted or paraphrased below:

- $\theta_{JA}$ , the thermal resistance from junction to ambient, is the natural convection junction-to-ambient air thermal resistance measured in a one cubic foot sealed enclosure. This environment is sometimes referred to as “still air” although natural convection causes the air to move. This value is determined with the part mounted to a 95mm × 76mm PCB with 4 layers.
- $\theta_{JCbottom}$ , the thermal resistance from the junction to the bottom of the product case, is determined with all of the component power dissipation flowing through the bottom of the package. In the typical  $\mu$ Module regulator, the bulk of the heat flows out of the bottom of the package, but there is always heat flow out into the ambient environment. As a result, this

thermal resistance value may be useful for comparing packages, but the test conditions do not generally match the user's application.

- $\theta_{JCtop}$ , the thermal resistance from the junction to the top of the product case, is determined with nearly all of the component power dissipation flowing through the top of the package. As the electrical connections of the  $\mu$ Module regulator are on the bottom of the package, it is rare for an application to operate such that most of the heat flows from the junction to the top of the part. As in the case of  $\theta_{JCbottom}$ , this value may be useful for comparing packages, but the test conditions do not generally match the user's application.
- $\theta_{JB}$ , the thermal resistance from the junction to the printed circuit board, is the junction-to-board thermal resistance where almost all of the heat flows through the bottom of the  $\mu$ Module regulator and into the board. It is really the sum of the  $\theta_{JCbottom}$  and the thermal resistance of the bottom of the part through the solder joints and through a portion of the board. The board temperature is measured a specified distance from the package.

A graphical representation of the aforementioned thermal resistances is given in Figure 8. Blue resistances are contained within the  $\mu$ Module package, whereas green resistances are external to the  $\mu$ Module package.

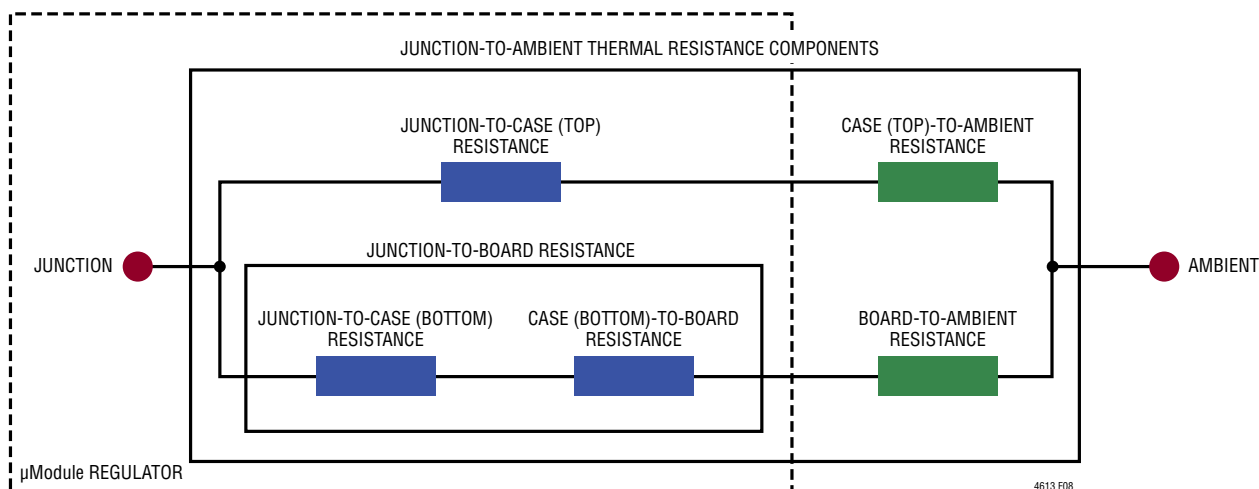

Figure 8. Graphical Representation of JESD51-12 Thermal Coefficients

## APPLICATIONS INFORMATION

As a practical matter, it should be clear to the reader that no individual or subgroup of the four thermal resistance parameters defined by JEDEC51-12, or provided in the Pin Configuration section, replicates or conveys normal operating conditions of a  $\mu$ Module regulator. For example, in normal board-mounted applications, never does 100% of the device's total power loss (heat) thermally conduct exclusively through the top or exclusively through bottom of the package—as the standard defines for  $\theta_{JCtop}$  and  $\theta_{JCbottom}$ , respectively. In practice, power loss is thermally dissipated in both directions away from the package. Granted, in the absence of a heat sink and airflow, the majority of the heat flow is into the board.

Within the LTM4613, be aware that there are multiple power devices and components dissipating power, with a consequence that the thermal resistances relative to different junctions of components or die are not exactly linear with respect to total package power loss. To reconcile this complication without sacrificing modeling simplicity—but also, not ignoring practical realities—an approach has been taken using FEA software modeling along with laboratory testing in a controlled-environment chamber to reasonably define and correlate the thermal resistance values supplied in this data sheet:

1. Initially, FEA software is used to accurately build the mechanical geometry of the LTM4613 and the specified PCB with all of the correct material coefficients, along with accurate power loss source definitions.
2. This model simulates a software-defined JEDEC environment consistent with JEDEC51-12 to predict power loss heat flow and temperature readings at different interfaces that enable the calculation of the JEDEC-defined thermal resistance values.
3. The model and FEA software is used to evaluate the LTM4613 with heat sink and airflow.
4. Having solved for, and analyzed these thermal resistance values and simulated various operating conditions in the software model, a thorough laboratory evaluation replicates the simulated conditions with thermocouples within a controlled-environment chamber while operating the device at the same power loss as that which was simulated. The outcome of this process and due diligence yields the set of derating curves provided in this data sheet.

The power loss curves in Figures 9 and 10 can be used in coordination with the load current derating curves in Figures 11 to 16 for calculating an approximate  $\theta_{JA}$  for the LTM4613. Each figure has three curves that are taken at three different airflow conditions. Graph designation delineates between no heat sink, and a BGA heat sink. Each of the load current derating curves will lower the maximum load current as a function of the increased ambient temperature to keep the maximum junction temperature of the power module at 120°C maximum. This will maintain the maximum operating temperature below 125°C. Table 3 provides the approximate  $\theta_{JA}$  for Figures 11 to 16. A complete explanation of the thermal characteristics is provided in the thermal application note, AN110.

### Safety Considerations

The LTM4613 does not provide galvanic isolation from  $V_{IN}$  to  $V_{OUT}$ . There is no internal fuse. If required, a slow blow fuse with a rating twice the maximum input current needs to be provided to protect each unit from catastrophic failure.

# APPLICATIONS INFORMATION

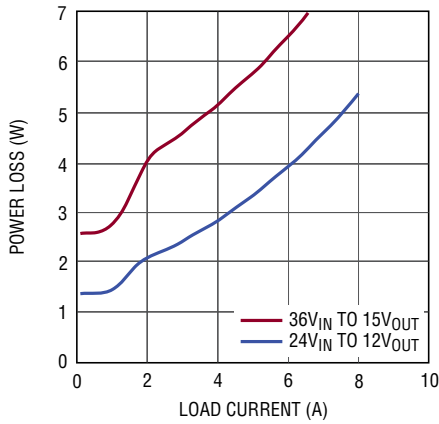

4613 F09

Figure 9. Power Loss at 12V<sub>OUT</sub> and 15V<sub>OUT</sub>

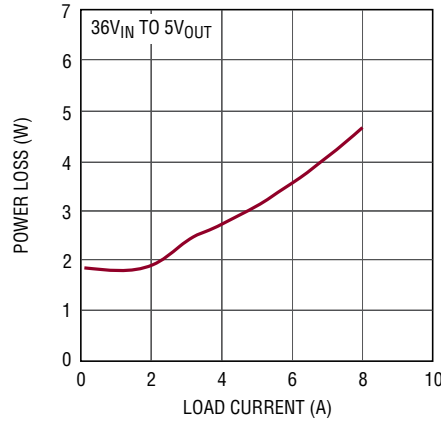

4613 F10

Figure 10. Power Loss at 5V<sub>OUT</sub>

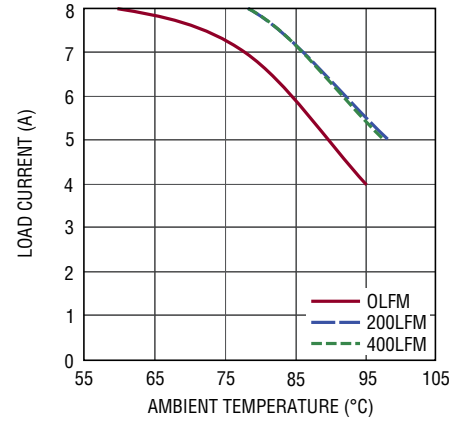

4613 F11

Figure 11. No Heat Sink with 36V<sub>IN</sub> to 5V<sub>OUT</sub>

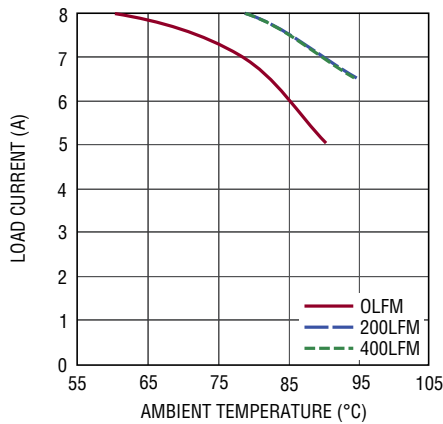

4613 F12

Figure 12. BGA Heat Sink with 36V<sub>IN</sub> to 5V<sub>OUT</sub>

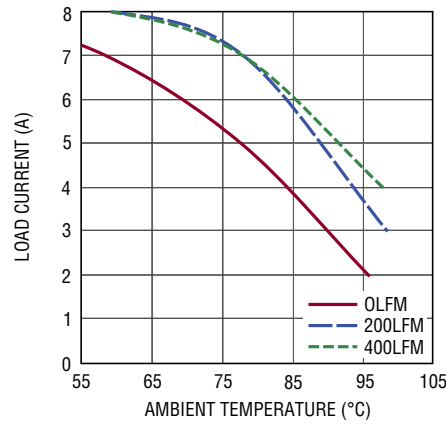

4613 F13

Figure 13. No Heat Sink with 24V<sub>IN</sub> to 12V<sub>OUT</sub>

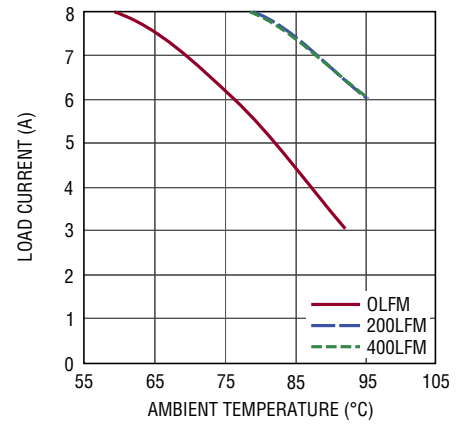

4613 F14

Figure 14. BGA Heat Sink with 24V<sub>IN</sub> to 12V<sub>OUT</sub>

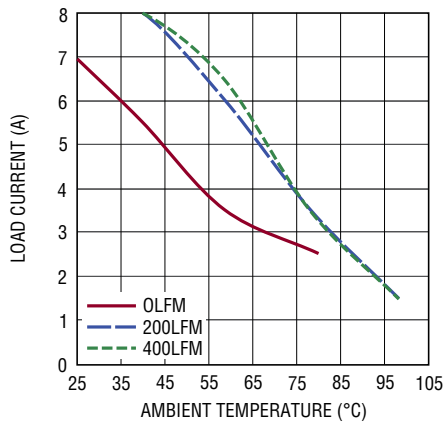

4613 F15

Figure 15. No Heat Sink with 36V<sub>IN</sub> to 15V<sub>OUT</sub>

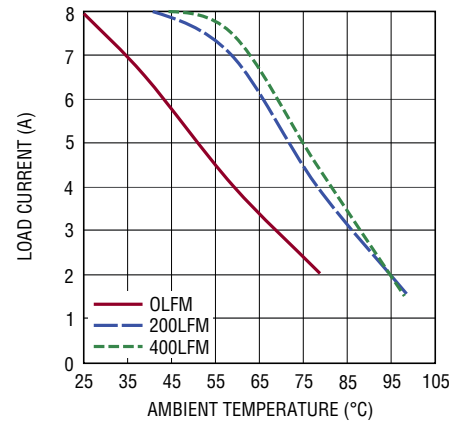

4613 F16

Figure 16. BGA Heat Sink with 36V<sub>IN</sub> to 15V<sub>OUT</sub>

## APPLICATIONS INFORMATION

**Table 3. 12V and 15V Outputs**

DERATING CURVE	V <sub>IN</sub> (V)	POWER LOSS CURVE	AIRFLOW (LFM)	HEAT SINK	θ <sub>JA</sub> (°C/W)
Figures 13, 15	24, 36	Figure 9	0	None	10
Figures 13, 15	24, 36	Figure 9	200	None	8
Figures 13, 15	24, 36	Figure 9	400	None	7
Figures 14, 16	24, 36	Figure 9	0	BGA Heat Sink	9.5
Figures 14, 16	24, 36	Figure 9	200	BGA Heat Sink	6.5
Figures 14, 16	24, 36	Figure 9	400	BGA Heat Sink	6.5

**Table 4. 5V Output**

DERATING CURVE	V <sub>IN</sub> (V)	POWER LOSS CURVE	AIRFLOW (LFM)	HEAT SINK	θ <sub>JA</sub> (°C/W)
Figure 11	36	Figure 10	0	None	8.5
Figure 11	36	Figure 10	200	None	6.5
Figure 11	36	Figure 10	400	None	6.5
Figure 12	36	Figure 10	0	BGA Heat Sink	8
Figure 12	36	Figure 10	200	BGA Heat Sink	6
Figure 12	36	Figure 10	400	BGA Heat Sink	6

**Table 5. Heat Sink Manufacturers**

HEAT SINK MANUFACTURER	PART NUMBER	WEBSITE
AAVID Thermalloy	375424B00034G	www.aavidthermalloy.com
Cool Innovations	4-050503P to 4-050508P	www.coolinnovations.com

### Layout Checklist/Example

The high integration of LTM4613 makes the PCB board layout very simple and easy. However, to optimize its electrical and thermal performance, some layout considerations are still necessary.

- Use large PCB copper areas for high current path, including V<sub>IN</sub>, PGND and V<sub>OUT</sub>. It helps to minimize the PCB conduction loss and thermal stress.
- Place high frequency ceramic input and output capacitors next to the V<sub>D</sub>, PGND and V<sub>OUT</sub> pins to minimize high frequency noise.
- Place a dedicated power ground layer underneath the unit.
- Use round corners for the PCB copper layer to minimize the radiated noise.
- To minimize the EMI noise and reduce module thermal stress, use multiple vias for interconnection between top layer and other power layers.
- Do not put vias directly on pads.
- If vias are placed onto the pads, the the vias must be capped.
- Interstitial via placement can also be used if necessary.
- Use a separated SGND ground copper area for components connected to signal pins. Connect the SGND to PGND underneath the unit.
- Place one or more high frequency ceramic capacitors close to the connection into the system board.

Figure 17 gives a good example of the recommended layout.



## APPLICATIONS INFORMATION

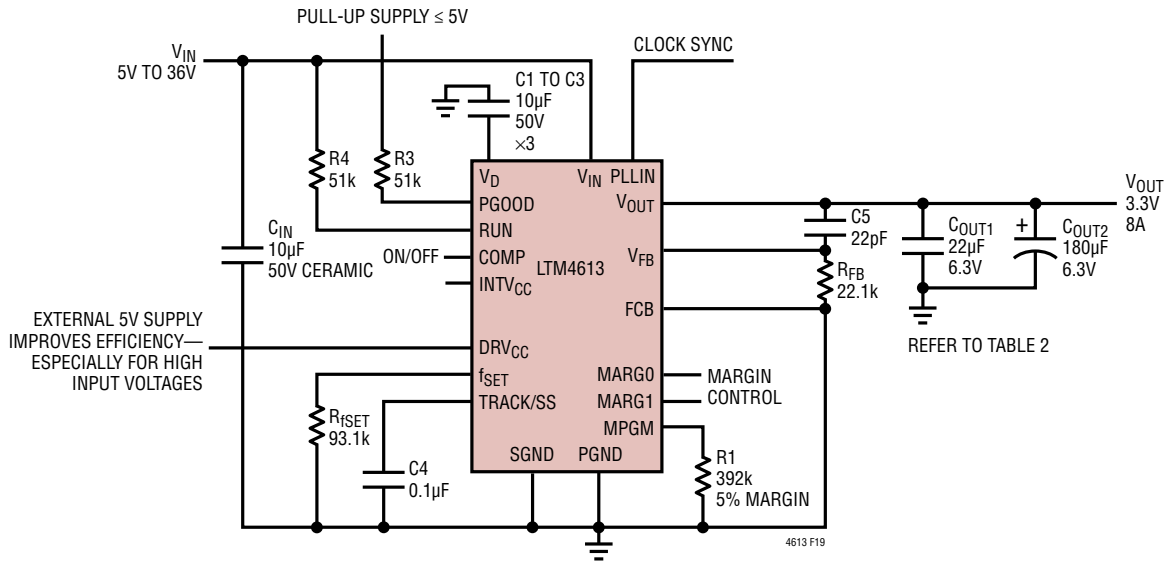

Figure 19. Typical 5V to 36V<sub>IN</sub>, 3.3V at 8A Design with 400kHz Frequency

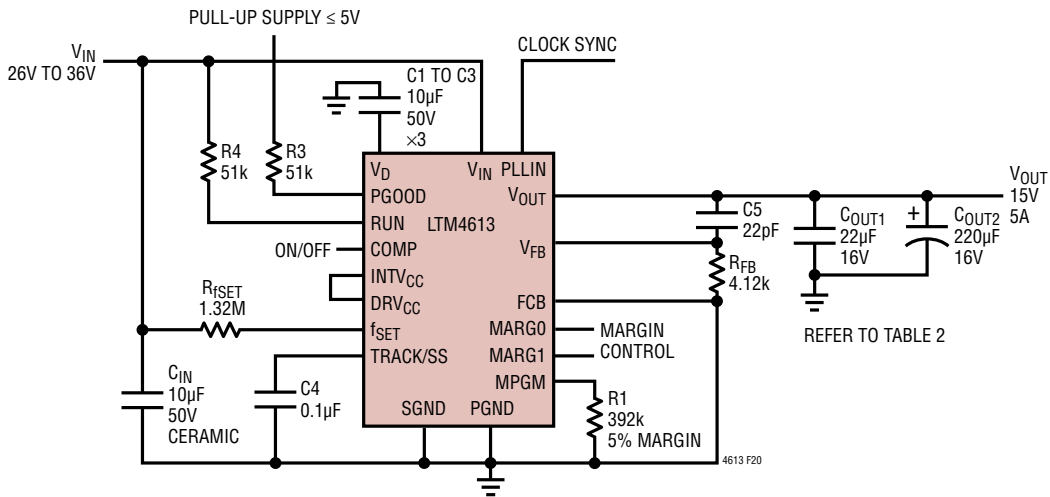

Figure 20. 26V to 36V<sub>IN</sub>, 15V at 5A Design with 600kHz Frequency

APPLICATIONS INFORMATION

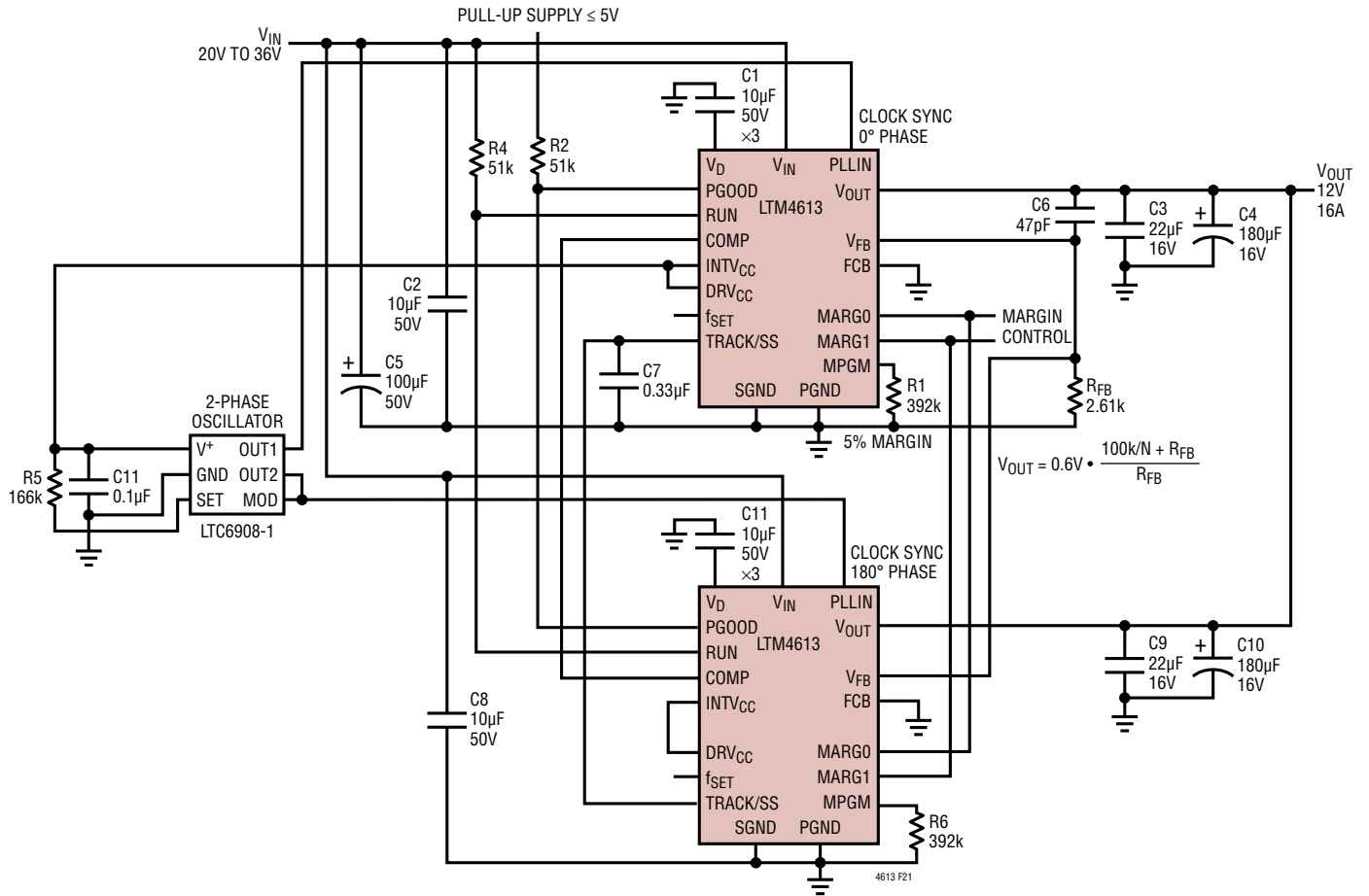

Figure 21. 2-Phase, Parallel 12V at 16A Design with 600kHz Frequency



APPLICATIONS INFORMATION

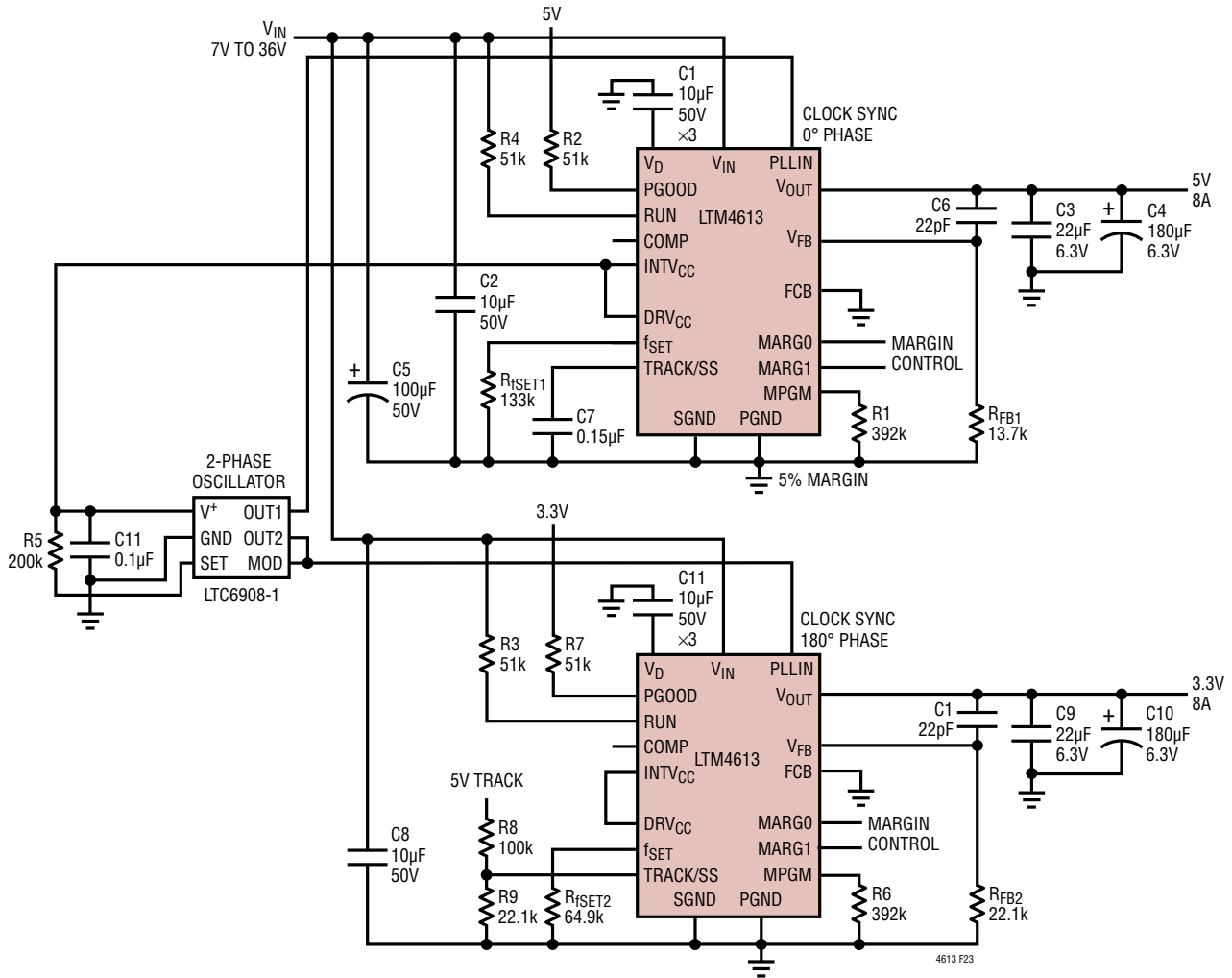

Figure 23. 2-Phase, 5V and 3.3V at 8A Design with 500kHz Frequency and Output Voltage Tracking

## PACKAGE DESCRIPTION

Pin Assignment Tables  
(Arranged by Pin Function)

PIN NAME		PIN NAME		PIN NAME		PIN NAME	
A1	V <sub>IN</sub>	D1	PGND	J1	V <sub>OUT</sub>	A6	V <sub>D</sub>
A2	V <sub>IN</sub>	D2	PGND	J2	V <sub>OUT</sub>	A7	INTV <sub>CC</sub>
A3	V <sub>IN</sub>	D3	PGND	J3	V <sub>OUT</sub>	A8	PLLIN
A4	V <sub>IN</sub>	D4	PGND	J4	V <sub>OUT</sub>	A9	TRACK/SS
A5	V <sub>IN</sub>	D5	PGND	J5	V <sub>OUT</sub>	A10	RUN
B1	V <sub>IN</sub>	D6	PGND	J6	V <sub>OUT</sub>	A11	COMP
B2	V <sub>IN</sub>	E1	PGND	J7	V <sub>OUT</sub>	A12	MPGM
B3	V <sub>IN</sub>	E2	PGND	J8	V <sub>OUT</sub>	B6	V <sub>D</sub>
B4	V <sub>IN</sub>	E3	PGND	J9	V <sub>OUT</sub>	B7	V <sub>D</sub>
B5	V <sub>IN</sub>	E4	PGND	J10	V <sub>OUT</sub>	B8	–
		E5	PGND	J11	V <sub>OUT</sub>	B9	RUN
		E6	PGND	K1	V <sub>OUT</sub>	B10	–
		E7	PGND	K2	V <sub>OUT</sub>	B11	MPGM
		E8	PGND	K3	V <sub>OUT</sub>	B12	f <sub>SET</sub>
		F1	PGND	K4	V <sub>OUT</sub>	C1	V <sub>D</sub>
		F2	PGND	K5	V <sub>OUT</sub>	C2	V <sub>D</sub>
		F3	PGND	K6	V <sub>OUT</sub>	C3	V <sub>D</sub>
		F4	PGND	K7	V <sub>OUT</sub>	C4	V <sub>D</sub>
		F5	PGND	K8	V <sub>OUT</sub>	C5	V <sub>D</sub>
		F6	PGND	K9	V <sub>OUT</sub>	C6	V <sub>D</sub>
		F7	PGND	K10	V <sub>OUT</sub>	C7	V <sub>D</sub>
		F8	PGND	K11	V <sub>OUT</sub>	C8	–
		F9	PGND	L1	V <sub>OUT</sub>	C9	–
		G1	PGND	L2	V <sub>OUT</sub>	C10	DRV <sub>CC</sub>
		G2	PGND	L3	V <sub>OUT</sub>	C11	MARG1
		G3	PGND	L4	V <sub>OUT</sub>	C12	MARG0
		G4	PGND	L5	V <sub>OUT</sub>	D7	–
		G5	PGND	L6	V <sub>OUT</sub>	D8	–
		G6	PGND	L7	V <sub>OUT</sub>	D9	SGND
		G7	PGND	L8	V <sub>OUT</sub>	D10	–
		G8	PGND	L9	V <sub>OUT</sub>	D11	COMP
		G9	PGND	L10	V <sub>OUT</sub>	D12	MARG1
		G10	PGND	L11	V <sub>OUT</sub>	E9	–
		G11	PGND	M1	V <sub>OUT</sub>	E10	–
		H1	PGND	M2	V <sub>OUT</sub>	E11	DRV <sub>CC</sub>
		H2	PGND	M3	V <sub>OUT</sub>	E12	DRV <sub>CC</sub>
		H3	PGND	M4	V <sub>OUT</sub>	F10	–
		H4	PGND	M5	V <sub>OUT</sub>	F11	–
		H5	PGND	M6	V <sub>OUT</sub>	F12	V <sub>FB</sub>
		H6	PGND	M7	V <sub>OUT</sub>	G12	PGOOD
		H7	PGND	M8	V <sub>OUT</sub>	H12	SGND
		H8	PGND	M9	V <sub>OUT</sub>	J12	NC
		H9	PGND	M10	V <sub>OUT</sub>	K12	NC
		H10	PGND	M11	V <sub>OUT</sub>	L12	NC
		H11	PGND			M12	FCB

# PACKAGE DESCRIPTION

Please refer to <http://www.linear.com/product/LTM4613#packaging> for the most recent package drawings.

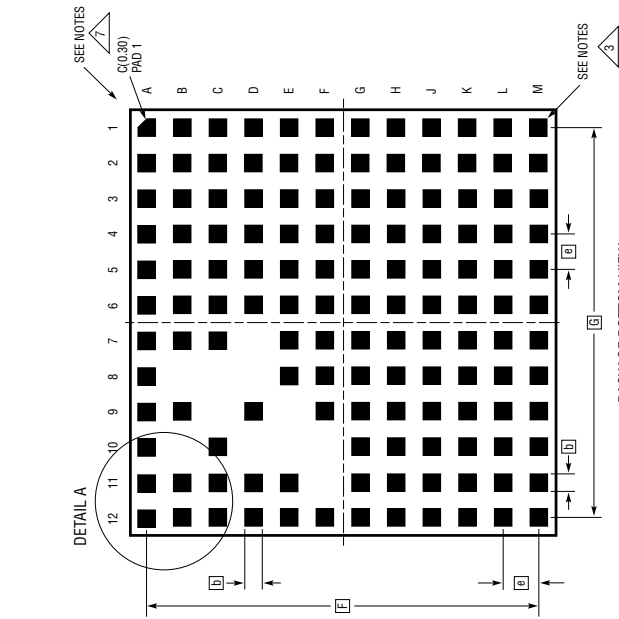

- NOTES:
1. DIMENSIONING AND TOLERANCING PER ASME Y14.5M-1994
  2. ALL DIMENSIONS ARE IN MILLIMETERS
  3. LAND DESIGNATION PER JEDEC MO-222, SPP-010
  4. DETAILS OF PAD #1 IDENTIFIER ARE OPTIONAL, BUT MUST BE LOCATED WITHIN THE ZONE INDICATED. THE PAD #1 IDENTIFIER MAY BE EITHER A MOLD OR MARKED FEATURE
  5. PRIMARY DATUM -Z- IS SEATING PLANE
  6. THE TOTAL NUMBER OF PADS: 133
  7. PACKAGE ROW AND COLUMN LABELING MAY VARY AMONG  $\mu$ Module PRODUCTS. REVIEW EACH PACKAGE LAYOUT CAREFULLY

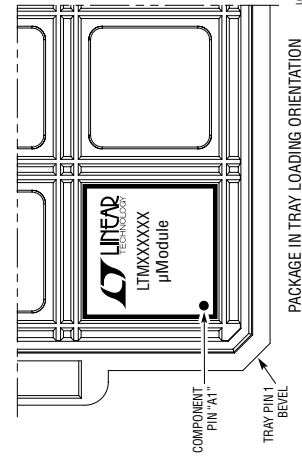

**LGA Package**  
**133-Lead (15mm × 15mm × 4.32mm)**  
 (Reference LTC DWG # 05-08-1884 Rev A)

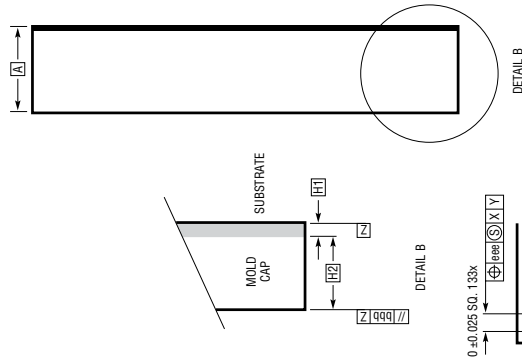

SYMBOL	DIMENSIONS		NOTES
	MIN	NOM	
A	4.22	4.32	4.42
b	0.60	0.63	0.66
D	15.0		
E	15.0		
e	1.27		
F	13.97		
G	13.97		
H1	0.27	0.32	0.37
H2	3.95	4.00	4.05
aaa	0.15		
bbb	0.10		
eee	0.05		
TOTAL NUMBER OF LGA PADS: 133			

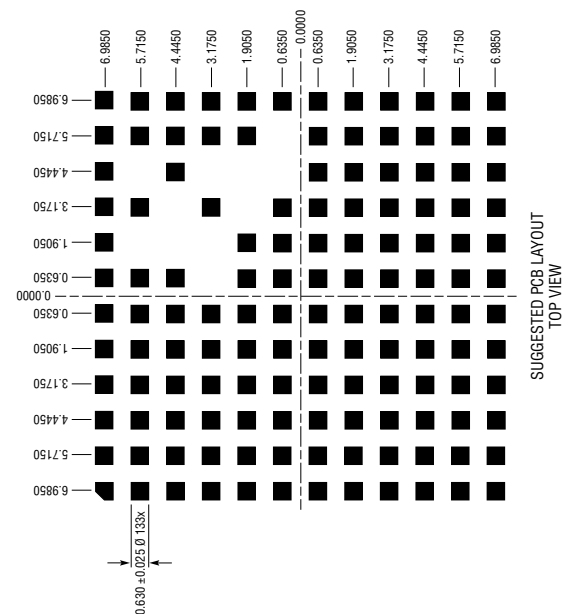

## PACKAGE DESCRIPTION

Please refer to <http://www.linear.com/product/LTM4613#packaging> for the most recent package drawings.

**BGA Package**  
**133-Lead (15mm × 15mm × 4.92mm)**  
 (Reference LTC DWG # 05-08-1992 Rev 0)

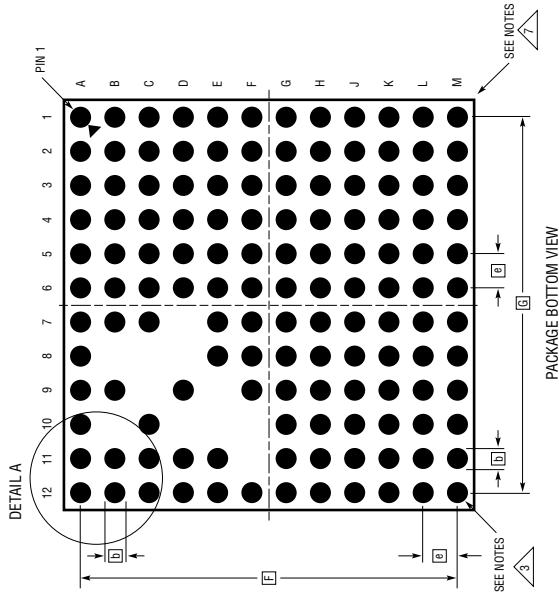

- NOTES:
1. DIMENSIONING AND TOLERANCING PER ASME Y14.5M-1994
  2. ALL DIMENSIONS ARE IN MILLIMETERS
  3. BALL DESIGNATION PER JEDEC MS-028 AND JEP95
  4. DETAILS OF PIN #1 IDENTIFIER ARE OPTIONAL, BUT MUST BE LOCATED WITHIN THE ZONE INDICATED. THE PIN #1 IDENTIFIER MAY BE EITHER A MOLD OR MARKED FEATURE
  5. PRIMARY DATUM - Z - IS SEATING PLANE
  6. SOLDER BALL COMPOSITION IS 96.5% Sn/3.0% Ag/0.5% Cu
  7. PACKAGE ROW AND COLUMN LABELING MAY VARY AMONG  $\mu$ Module PRODUCTS. REVIEW EACH PACKAGE LAYOUT CAREFULLY

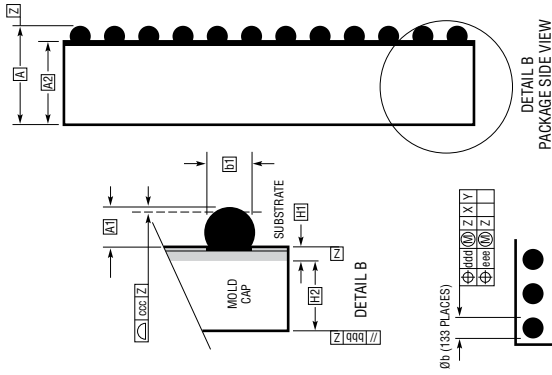
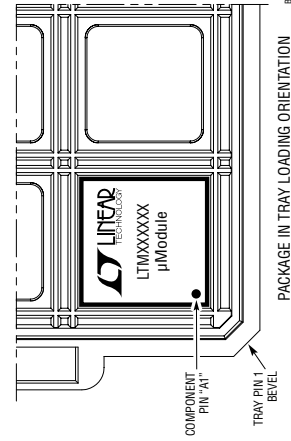

SYMBOL	DIMENSIONS			NOTES
	MIN	NOM	MAX	
A	4.72	4.92	5.12	
A1	0.50	0.60	0.70	
A2	4.22	4.32	4.42	
b	0.60	0.75	0.90	
b1	0.60	0.63	0.66	
D	15.0			
E	15.0			
e	1.27			
F	13.97			
G	13.97			
H1	0.27	0.32	0.37	
H2	3.95	4.00	4.05	
aaa	0.15			
bbb	0.10			
ccc	0.20			
ddd	0.30			
eee	0.15			
TOTAL NUMBER OF BALLS: 133				

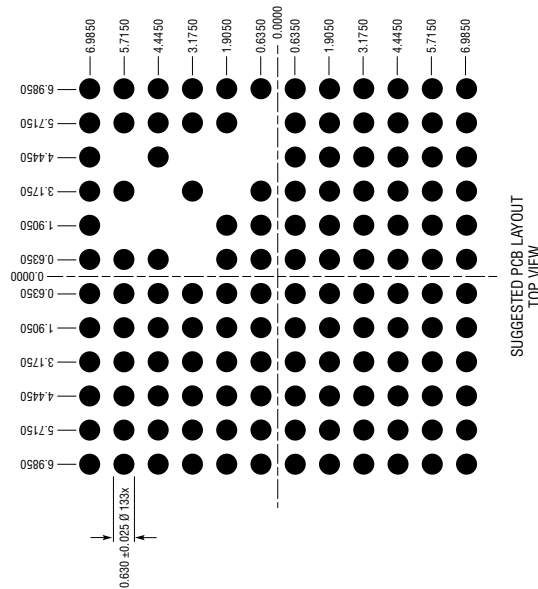
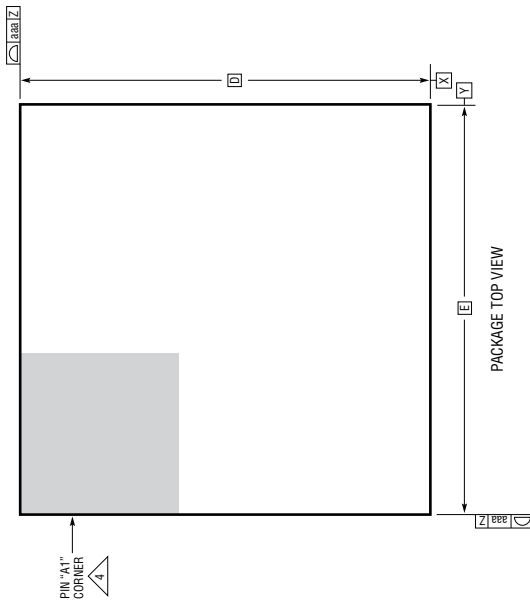

## REVISION HISTORY

REV	DATE	DESCRIPTION	PAGE NUMBER
A	06/15	Added BGA Package	2, 28
B	09/15	Added LTM4613IY (SnPb)	2
C	07/16	Added MP-Grade	2
D	09/16	Changed Max value of $V_{INTVCC}$ of 5.3 to 5.5	3

# LTM4613

## PACKAGE PHOTOGRAPH



## DESIGN RESOURCES

SUBJECT	DESCRIPTION
<a href="#">μModule Design and Manufacturing Resources</a>	<p>Design:</p> <ul style="list-style-type: none"> <li>• Selector Guides</li> <li>• Demo Boards and Gerber Files</li> <li>• Free Simulation Tools</li> </ul> <p>Manufacturing:</p> <ul style="list-style-type: none"> <li>• Quick Start Guide</li> <li>• PCB Design, Assembly and Manufacturing Guidelines</li> <li>• Package and Board Level Reliability</li> </ul>
<a href="#">μModule Regulator Products Search</a>	<ol style="list-style-type: none"> <li>1. Sort table of products by parameters and download the result as a spreadsheet.</li> <li>2. Search using the <a href="#">Quick Power Search</a> parametric table.</li> </ol> <div style="border: 1px solid #ccc; padding: 5px; margin-top: 10px;"> <p>Quick Power Search</p> <p>Input <math>V_{in}</math> (Min) <input type="text"/> V <math>V_{in}</math> (Max) <input type="text"/> V</p> <p>Output <math>V_{out}</math> <input type="text"/> V <math>I_{out}</math> <input type="text"/> A</p> <p style="text-align: right;"><input type="button" value="Search"/></p> </div>
<a href="#">TechClip Videos</a>	Quick videos detailing how to bench test electrical and thermal performance of μModule products.
<a href="#">Digital Power System Management</a>	Linear Technology's family of digital power supply management ICs are highly integrated solutions that offer essential functions, including power supply monitoring, supervision, margining and sequencing, and feature EEPROM for storing user configurations and fault logging.

## RELATED PARTS

PART NUMBER	DESCRIPTION	COMMENTS
<a href="#">LTM4612</a>	Lower $I_{OUT}$ Than LTM4613, EN55022B Compliant, 36V <sub>IN</sub> , 5A μModule Regulator	$5V \leq V_{IN} \leq 36V$ , $3.3V \leq V_{OUT} \leq 15V$ , 15mm × 15mm × 2.82mm (LGA)
<a href="#">LTM4606</a>	EN55022B Compliant, 28V <sub>IN</sub> , 6A μModule Regulator	$4.5V \leq V_{IN} \leq 28V$ , $0.5V \leq V_{OUT} \leq 5V$ , 15mm × 15mm × 2.82mm (LGA), 15mm × 15mm × 3.42mm (BGA)
<a href="#">LTM8031</a>	EN55022B Compliant, 36V <sub>IN</sub> , 1A μModule Regulator	$3.6V \leq V_{IN} \leq 36V$ , $0.8V \leq V_{OUT} \leq 10V$ , 9mm × 15mm × 2.82mm (LGA), 9mm × 15mm × 3.42mm (BGA)
<a href="#">LTM8032</a>	EN55022B Compliant, 36V <sub>IN</sub> , 2A μModule Regulator	$3.6V \leq V_{IN} \leq 36V$ , $0.8V \leq V_{OUT} \leq 10V$ , 9mm × 15mm × 2.82mm (LGA), 9mm × 15mm × 3.42mm (BGA)
<a href="#">LTM8033</a>	EN55022B Compliant, 36V <sub>IN</sub> , 3A μModule Regulator	$3.6V \leq V_{IN} \leq 36V$ , $0.8V \leq V_{OUT} \leq 24V$ , 11.25mm × 15mm × 4.32mm (LGA), 11.25mm × 15mm × 4.92mm (BGA)
<a href="#">LTM8028</a>	Low Output Noise, 36V <sub>IN</sub> , 5A μModule Regulator	$6V \leq V_{IN} \leq 36V$ , $0.8V \leq V_{OUT} \leq 1.8V$ , 15mm × 15mm × 4.92mm (BGA)
<a href="#">LTM4601AHV</a>	28V <sub>IN</sub> , 12A μModule Regulator with PLL, Tracking and Margining	$4.5V \leq V_{IN} \leq 28V$ , $0.6V \leq V_{OUT} \leq 5V$ , 15mm × 15mm × 2.82mm (LGA), 15mm × 15mm × 3.42mm (BGA)
<a href="#">LTM4641</a>	38V <sub>IN</sub> , 10A μModule Regulator with Input and Load Protection	$4.5V \leq V_{IN} \leq 38V$ , $0.6V \leq V_{OUT} \leq 6V$ , 15mm × 15mm × 5.01mm (BGA)
<a href="#">LTM8003</a>	FMEA Compliant Pinout, 150°C Operation, 40V <sub>IN</sub> , 3.5A μModule Regulator	$3.4V \leq V_{IN} \leq 40V$ , $0.97V \leq V_{OUT} \leq 18V$ , 6.25mm × 9mm × 3.32mm (BGA)
<a href="#">LTM8053</a>	40V <sub>IN</sub> , 3.5A μModule Regulator in 6.25mm × 9mm BGA Package	$3.4V \leq V_{IN} \leq 40V$ , $0.97V \leq V_{OUT} \leq 15V$ , 6.25mm × 9mm × 3.32mm (BGA)

4613fd

## Looking for pricing, stock, or lifecycle information?

Click below to explore more details on WIN SOURCE:

 [View LTM4613IY on WIN SOURCE](#)

 [Analog Devices Inc. Information](#)

## Optimize Your Supply Chain with WIN SOURCE Solutions

-  Global Sourcing Solution
-  Obsolete Management
-  Cost Control Management
-  Shortage Management
-  Alternative Solution
-  Excess Inventory Management