

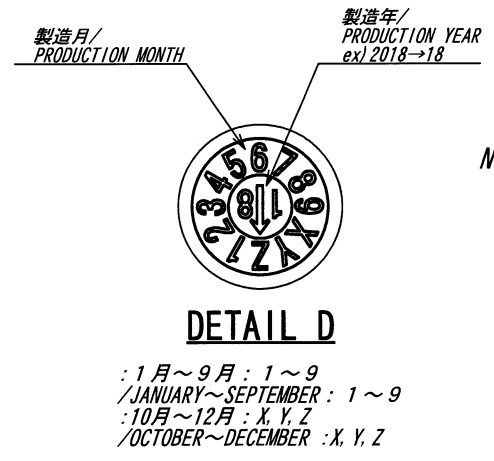

**THE DATASHEET OF
IMSA-13103S-02Y500**

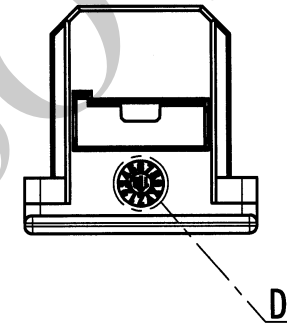

極数 POS.	品番 No.	A	B	C
2	13103S-02*-NP	11.4	6	2
4	13103S-04*-NP	15.4	10	6
8	13103S-08*-NP	23.4	18	14
10	13103S-10*-NP	27.4	22	18
12	13103S-12*-NP	31.4	26	22
16	13103S-16*-NP	39.4	34	30
20	13103S-20*-NP	47.4	42	38

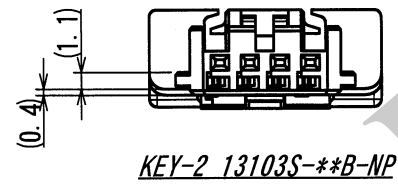
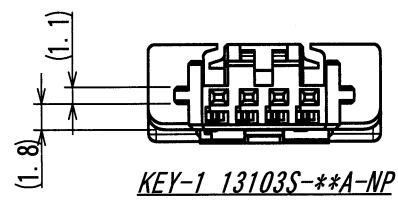
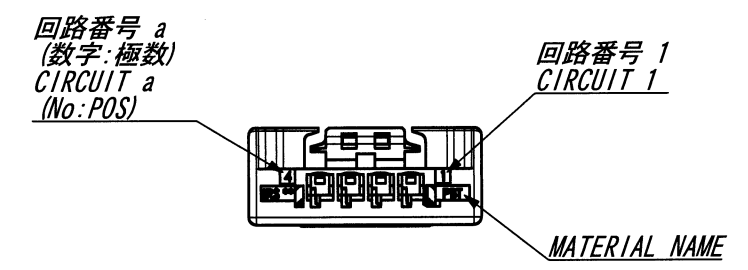
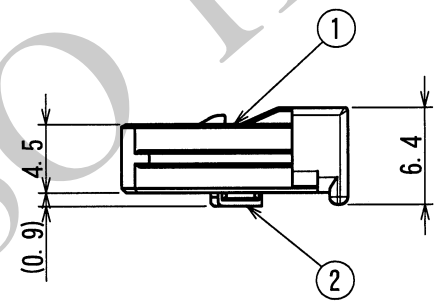
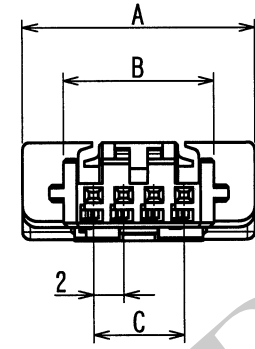
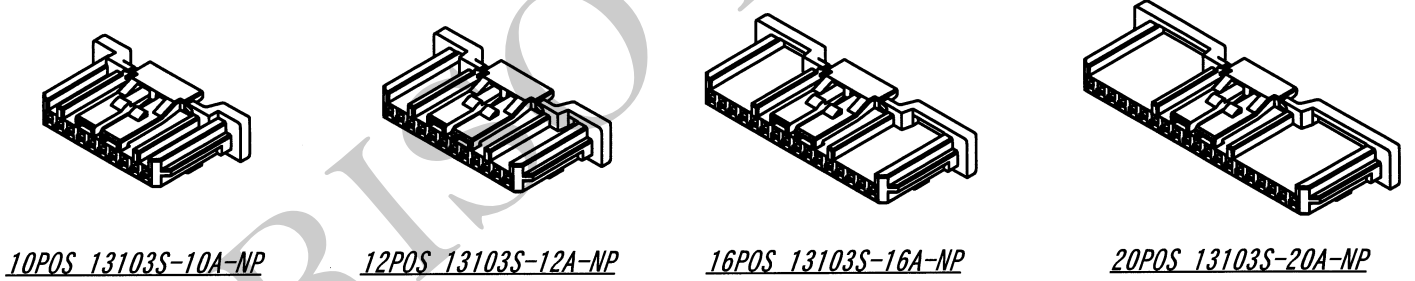
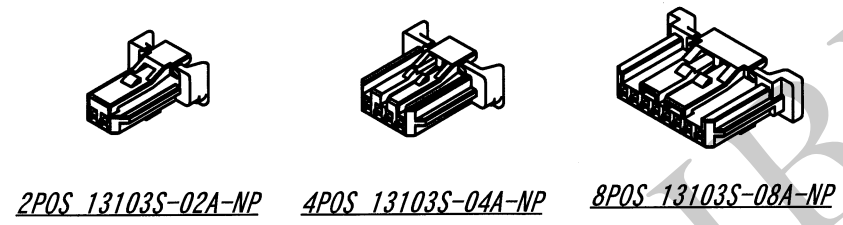
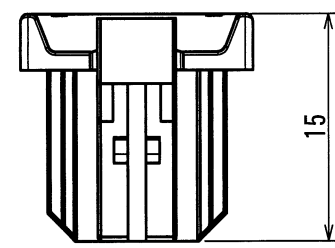

NOTE:

1. 仮係止時リテーナ突起がハウジングの外側に出ていること。
(リテーナが仮係止状態。)
納品時、本係止状態になっている場合は、仮係止状態にして下さい。

1. THE RETENTION LATCH OF THE RETAINER MUST BE OUT SIDE OF SOCKET HOUSING WHEN PRE-ASSEMBLY. (RETAINER IS IN PRE-ASSEMBLED CONDITION) WHEN THE RETAINER IS IN FINAL LOCK CONDITION AT THE SHIPPED TO CUSTOMER, IT MUST BE UNLOCKED TO PRE-ASSEMBLED CONDITION.

MATERIAL 材質						GENERAL TOLERANCES 一般公差		SCALE 尺度		UNIT 単位		TITLE 名称	
①SOCKET HOUSING : PBT樹脂,UL94 V0、黒色/ PBT ,UL94 V0,COLOR:BLACK						DIM 寸法 ± 0.3		2:1		mm		13103シリーズ ソケット SERIES 13103 SOCKET	
②RETAINER : PBT樹脂,UL94 V0、ナチュラル/ PBT,UL94 V0,COLOR:NATURAL						ANGLE 角度 ± 3°		DR 2019.12.24 D.Kitazawa		DSN 2018.10.16 D.Kitazawa			
FINISH 仕上げ						3RD.ANG.PROJ. 三角法		CHK 2019.12.25 T. Sakamoto		APP 12/19 H. Koguchi		PARTS No. 部番 IMSA-13103S-***-NP	
192658 RELEASED D.K T.S '19 12/25								IRISO ELECTRONICS CO.,LTD イリス電子工業株式会社		DWG No. 図番 110-413103-415		SHEET No. 1 OF 1	
0 SCHETCHED D.K T.S '18 10/29												REV. 1	
LTR 記号 ECN No REVISION RECORD 記 事 DR CHK DATE 年月日													

Looking for pricing, stock, or lifecycle information?

Click below to explore more details on WIN SOURCE:

 [View IMSA-13103S-02Y500 on WIN SOURCE](#)

 [IRISO Information](#)

Optimize Your Supply Chain with WIN SOURCE Solutions

-  Global Sourcing Solution
-  Obsolete Management
-  Cost Control Management
-  Shortage Management
-  Alternative Solution
-  Excess Inventory Management