



**THE DATASHEET OF
BZX84C36LT1G**



BZX84BxxxLT1G, BZX84CxxxLT1G Series, SZBZX84BxxxLT1G, SZBZX84CxxxLT1G Series



ON Semiconductor®

www.onsemi.com

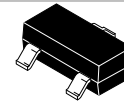

SOT-23
CASE 318
STYLE 8



Zener Voltage Regulators

250 mW SOT-23 Surface Mount

This series of Zener diodes is offered in the convenient, surface mount plastic SOT-23 package. These devices are designed to provide voltage regulation with minimum space requirement. They are well suited for applications such as cellular phones, hand held portables, and high density PC boards.

Features

- 250 mW Rating on FR-4 or FR-5 Board
- Zener Breakdown Voltage Range – 2.4 V to 75 V
- Package Designed for Optimal Automated Board Assembly
- Small Package Size for High Density Applications
- ESD Rating of Class 3 (> 16 kV) per Human Body Model
- Tight Tolerance Series Available (See Page 4)
- SZ Prefix for Automotive and Other Applications Requiring Unique Site and Control Change Requirements; AEC-Q101 Qualified and PPAP Capable
- These Devices are Pb-Free and are RoHS Compliant

Mechanical Characteristics

CASE: Void-free, transfer-molded, thermosetting plastic case

FINISH: Corrosion resistant finish, easily Solderable

MAXIMUM CASE TEMPERATURE FOR SOLDERING PURPOSES:

260°C for 10 Seconds

POLARITY: Cathode indicated by polarity band

FLAMMABILITY RATING: UL 94 V-0

MARKING DIAGRAM

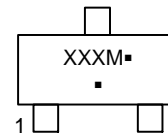

XXX = Device Code
M = Date Code*
▪ = Pb-Free Package

(Note: Microdot may be in either location)

*Date Code orientation may vary depending upon manufacturing location.

ORDERING INFORMATION

Device	Package	Shipping†
BZX84CxxxLT1G	SOT-23 (Pb-Free)	3,000 / Tape & Reel
SZBZX84CxxxLT1G	SOT-23 (Pb-Free)	3,000 / Tape & Reel
BZX84CxxxLT3G	SOT-23 (Pb-Free)	10,000 / Tape & Reel
SZBZX84CxxxLT3G	SOT-23 (Pb-Free)	10,000 / Tape & Reel
BZX84BxxxLT1G	SOT-23 (Pb-Free)	3,000 / Tape & Reel
SZBZX84BxxxLT1G	SOT-23 (Pb-Free)	3,000 / Tape & Reel
BZX84BxxxLT3G	SOT-23 (Pb-Free)	10,000 / Tape & Reel
SZBZX84BxxxLT3G	SOT-23 (Pb-Free)	10,000 / Tape & Reel

†For information on tape and reel specifications, including part orientation and tape sizes, please refer to our Tape and Reel Packaging Specification Brochure, BRD8011/D.

DEVICE MARKING INFORMATION

See specific marking information in the device marking column of the Electrical Characteristics table on page 3 of this data sheet.

*For additional information on our Pb-Free strategy and soldering details, please download the ON Semiconductor Soldering and Mounting Techniques Reference Manual, SOLDERRM/D.

BZX84BxxxLT1G, BZX84CxxxLT1G Series, SZBZX84BxxxLT1G, SZBZX84CxxxLT1G Series

MAXIMUM RATINGS

Rating	Symbol	Max	Unit
Total Power Dissipation on FR-5 Board, (Note 1) @ $T_A = 25^\circ\text{C}$ Derated above 25°C	P_D	250	mW
Thermal Resistance, Junction-to-Ambient	$R_{\theta JA}$	2.0	$\text{mW}/^\circ\text{C}$
		500	$^\circ\text{C}/\text{W}$
Total Power Dissipation on Alumina Substrate, (Note 2) @ $T_A = 25^\circ\text{C}$ Derated above 25°C	P_D	300	mW
Thermal Resistance, Junction-to-Ambient	$R_{\theta JA}$	2.4	$\text{mW}/^\circ\text{C}$
		417	$^\circ\text{C}/\text{W}$
Junction and Storage Temperature Range	T_J, T_{stg}	-65 to +150	$^\circ\text{C}$

Stresses exceeding those listed in the Maximum Ratings table may damage the device. If any of these limits are exceeded, device functionality should not be assumed, damage may occur and reliability may be affected.

- FR-5 = 1.0 X 0.75 X 0.62 in.
- Alumina = 0.4 X 0.3 X 0.024 in., 99.5% alumina.

ELECTRICAL CHARACTERISTICS

(Pinout: 1-Anode, 2-No Connection, 3-Cathode) ($T_A = 25^\circ\text{C}$ unless otherwise noted, $V_F = 0.90\text{ V Max.}$ @ $I_F = 10\text{ mA}$)

Symbol	Parameter
V_Z	Reverse Zener Voltage @ I_{ZT}
I_{ZT}	Reverse Current
Z_{ZT}	Maximum Zener Impedance @ I_{ZT}
I_R	Reverse Leakage Current @ V_R
V_R	Reverse Voltage
I_F	Forward Current
V_F	Forward Voltage @ I_F
ΘV_Z	Maximum Temperature Coefficient of V_Z
C	Max. Capacitance @ $V_R = 0$ and $f = 1\text{ MHz}$



BZX84BxxxLT1G, BZX84CxxxLT1G Series, SZBZX84BxxxLT1G, SZBZX84CxxxLT1G Series

ELECTRICAL CHARACTERISTICS – BZX84CxxxLT1 SERIES (STANDARD TOLERANCE)

(Pinout: 1-Anode, 2-No Connection, 3-Cathode) (T_A = 25°C unless otherwise noted, V_F = 0.90 V Max. @ I_F = 10 mA)
 (Devices listed in **bold, italic** are ON Semiconductor Preferred devices.)

Device*	Device Marking	V _{Z1} (Volts) @ I _{ZT1} = 5 mA (Note 3)			Z _{ZT1} (Ω) @ I _{ZT1} = 5 mA	V _{Z2} (V) @ I _{ZT2} = 1 mA (Note 3)		Z _{ZT2} (Ω) @ I _{ZT2} = 1 mA	V _{Z3} (V) @ I _{ZT3} = 20 mA (Note 3)		Z _{ZT3} (Ω) @ I _{ZT3} = 20 mA	Max Reverse Leakage Current		θ _{VZ} (mV/k) @ I _{ZT1} = 5 mA		C (pF) @ V _R = 0 f = 1 MHz
		Min	Nom	Max		Min	Max		Min	Max		I _R (μA)	V _R (Volts)	Min	Max	
BZX84C2V4LT1G	Z11	2.2	2.4	2.6	100	1.7	2.1	600	2.6	3.2	50	50	1	-3.5	0	450
BZX84C2V7LT1G	Z12	2.5	2.7	2.9	100	1.9	2.4	600	3	3.6	50	20	1	-3.5	0	450
BZX84C3V0LT1G	Z13	2.8	3	3.2	95	2.1	2.7	600	3.3	3.9	50	10	1	-3.5	0	450
BZX84C3V3LT1G	Z14	3.1	3.3	3.5	95	2.3	2.9	600	3.6	4.2	40	5	1	-3.5	0	450
BZX84C3V6LT1G	Z15	3.4	3.6	3.8	90	2.7	3.3	600	3.9	4.5	40	5	1	-3.5	0	450
BZX84C3V9LT1G	Z16	3.7	3.9	4.1	90	2.9	3.5	600	4.1	4.7	30	3	1	-3.5	-2.5	450
BZX84C4V3LT1G	W9	4	4.3	4.6	90	3.3	4	600	4.4	5.1	30	3	1	-3.5	0	450
BZX84C4V7LT1/T3G	Z1	4.4	4.7	5	80	3.7	4.7	500	4.5	5.4	15	3	2	-3.5	0.2	260
BZX84C5V1LT1/T3G	Z2	4.8	5.1	5.4	60	4.2	5.3	480	5	5.9	15	2	2	-2.7	1.2	225
BZX84C5V6LT1/T3G	Z3	5.2	5.6	6	40	4.8	6	400	5.2	6.3	10	1	2	-2.0	2.5	200
BZX84C6V2LT1/T3G	Z4	5.8	6.2	6.6	10	5.6	6.6	150	5.8	6.8	6	3	4	0.4	3.7	185
BZX84C6V8LT1/T3G	Z5	6.4	6.8	7.2	15	6.3	7.2	80	6.4	7.4	6	2	4	1.2	4.5	155
BZX84C7V5LT1G	Z6	7	7.5	7.9	15	6.9	7.9	80	7	8	6	1	5	2.5	5.3	140
BZX84C8V2LT1G	Z7	7.7	8.2	8.7	15	7.6	8.7	80	7.7	8.8	6	0.7	5	3.2	6.2	135
BZX84C9V1LT1/T3G	Z8	8.5	9.1	9.6	15	8.4	9.6	100	8.5	9.7	8	0.5	6	3.8	7.0	130
BZX84C10LT1G	Z9	9.4	10	10.6	20	9.3	10.6	150	9.4	10.7	10	0.2	7	4.5	8.0	130
BZX84C11LT1G	Y1	10.4	11	11.6	20	10.2	11.6	150	10.4	11.8	10	0.1	8	5.4	9.0	130
BZX84C12LT1G	Y2	11.4	12	12.7	25	11.2	12.7	150	11.4	12.9	10	0.1	8	6.0	10.0	130
BZX84C13LT1G	Y3	12.4	13	14.1	30	12.3	14	170	12.5	14.2	15	0.1	8	7.0	11.0	120
BZX84C15LT1/T3G	Y4	13.8	15	15.6	30	13.7	15.5	200	13.9	15.7	20	0.05	10.5	9.2	13.0	110
BZX84C16LT1G	Y5	15.3	16	17.1	40	15.2	17	200	15.4	17.2	20	0.05	11.2	10.4	14.0	105
BZX84C18LT1/T3G	Y6	16.8	18	19.1	45	16.7	19	225	16.9	19.2	20	0.05	12.6	12.4	16.0	100
BZX84C20LT1G	Y7	18.8	20	21.2	55	18.7	21.1	225	18.9	21.4	20	0.05	14	14.4	18.0	85
BZX84C22LT1G	Y8	20.8	22	23.3	55	20.7	23.2	250	20.9	23.4	25	0.05	15.4	16.4	20.0	85
BZX84C24LT1G	Y9	22.8	24	25.6	70	22.7	25.5	250	22.9	25.7	25	0.05	16.8	18.4	22.0	80
Device*	Device Marking	V _{Z1} Below @ I _{ZT1} = 2 mA			Z _{ZT1} Below @ I _{ZT1} = 2 mA	V _{Z2} Below @ I _{ZT2} = 0.1 mA		Z _{ZT2} Below @ I _{ZT2} = 0.5 mA	V _{Z3} Below @ I _{ZT3} = 10 mA		Z _{ZT3} Below @ I _{ZT3} = 10 mA	Max Reverse Leakage Current		θ _{VZ} (mV/k) Below @ I _{ZT1} = 2 mA		C (pF) @ V _R = 0 f = 1 MHz
		Min	Nom	Max		Min	Max		Min	Max		I _R (μA)	V _R (V)	Min	Max	
BZX84C27LT1G	Y10	25.1	27	28.9	80	25	28.9	300	25.2	29.3	45	0.05	18.9	21.4	25.3	70
BZX84C30LT1G	Y11	28	30	32	80	27.8	32	300	28.1	32.4	50	0.05	21	24.4	29.4	70
BZX84C33LT1/T3G	Y12	31	33	35	80	30.8	35	325	31.1	35.4	55	0.05	23.1	27.4	33.4	70
BZX84C36LT1G	Y13	34	36	38	90	33.8	38	350	34.1	38.4	60	0.05	25.2	30.4	37.4	70
BZX84C39LT1G	Y14	37	39	41	130	36.7	41	350	37.1	41.5	70	0.05	27.3	33.4	41.2	45
BZX84C43LT1G	Y15	40	43	46	150	39.7	46	375	40.1	46.5	80	0.05	30.1	37.6	46.6	40
BZX84C47LT1G	Y16	44	47	50	170	43.7	50	375	44.1	50.5	90	0.05	32.9	42.0	51.8	40
BZX84C51LT1G	Y17	48	51	54	180	47.6	54	400	48.1	54.6	100	0.05	35.7	46.6	57.2	40
BZX84C56LT1G	Y18	52	56	60	200	51.5	60	425	52.1	60.8	110	0.05	39.2	52.2	63.8	40
BZX84C62LT1G	Y19	58	62	66	215	57.4	66	450	58.2	67	120	0.05	43.4	58.8	71.6	35
BZX84C68LT1G	Y20	64	68	72	240	63.4	72	475	64.2	73.2	130	0.05	47.6	65.6	79.8	35
BZX84C75LT1G	Y21	70	75	79	255	69.4	79	500	70.3	80.2	140	0.05	52.5	73.4	88.6	35

3. Zener voltage is measured with a pulse test current I_Z at an ambient temperature of 25°C.

*Includes SZ-prefix devices where applicable.

BZX84BxxxLT1G, BZX84CxxxLT1G Series, SZBZX84BxxxLT1G, SZBZX84CxxxLT1G Series

ELECTRICAL CHARACTERISTICS – BZX84BxxxL (Tight Tolerance Series)

(Pinout: 1-Anode, 2-No Connection, 3-Cathode) ($T_A = 25^\circ\text{C}$ unless otherwise noted, $V_F = 0.90\text{ V Max.}$ @ $I_F = 10\text{ mA}$)

Device	Device Marking	V_Z (Volts) @ $I_{ZT} = 5\text{ mA}$ (Note 4)			$Z_{ZT} (\Omega)$ @ $I_{ZT} = 5\text{ mA}$ (Note 4)	Max Reverse Leakage Current		θ_{VZ} (mV/k) @ $I_{ZT} = 5\text{ mA}$		C (pF) @ $V_R = 0$, f = 1 MHz
						I_R	V_R			
		Min	Nom	Max	Max	μA	@ Volts	Min	Max	
BZX84B3V3LT1G	T2A	3.23	3.3	3.37	95	5	1	-3.5	0	450
BZX84B4V7LT1G	T10	4.61	4.7	4.79	80	3	2	-3.5	0.2	260
BZX84B5V1LT1G	T11	5.00	5.1	5.20	60	2	2	-2.7	1.2	225
BZX84B5V6LT1G	T12	5.49	5.6	5.71	40	1	2	-2	2.5	200
BZX84B6V2LT1G	T13	6.08	6.2	6.32	10	3	4	0.4	3.7	185
BZX84B6V8LT1G	T14	6.66	6.8	6.94	15	2	4	1.2	4.5	155
BZX84B7V5LT1G	T15	7.35	7.5	7.65	15	1	5	2.5	5.3	140
BZX84B8V2LT1G	T16	8.04	8.2	8.36	15	0.7	5	3.2	6.2	135
BZX84B9V1LT1G, T3G	T17	8.92	9.1	9.28	15	0.5	6	3.8	7	130
BZX84B10LT1G	T2E	9.8	10	10.2	20	0.2	7	4.5	8	130
BZX84B12LT1G	T18	11.8	12	12.2	25	0.1	8	6	10	130
BZX84B15LT1G	T22	14.7	15	15.3	30	0.05	10.5	9.2	13	110
BZX84B16LT1G	T19	15.7	16	16.3	40	0.05	11.2	10.4	14	105
BZX84B18LT1G	T20	17.6	18	18.4	45	0.05	12.6	12.4	16	100
BZX84B22LT1G	T24	21.6	22	22.4	55	0.05	15.4	16.4	20	85
BZX84B24LT1G	T25	23.5	24	24.5	70	0.05	16.8	18.4	22	80

4. Zener voltage is measured with a pulse test current I_Z at an ambient temperature of 25°C .

ELECTRICAL CHARACTERISTICS – BZX84BxxxL (Tight Tolerance Series)

(Pinout: 1-Anode, 2-No Connection, 3-Cathode) ($T_A = 25^\circ\text{C}$ unless otherwise noted, $V_F = 0.90\text{ V Max.}$ @ $I_F = 10\text{ mA}$)

Device*	Device Marking	V_Z (Volts) @ $I_{ZT} = 2\text{ mA}$ (Note 4)			$Z_{ZT} (\Omega)$ @ $I_{ZT} = 2\text{ mA}$ (Note 4)	Max Reverse Leakage Current		θ_{VZ} (mV/k) @ $I_{ZT} = 2\text{ mA}$		C (pF) @ $V_R = 0$, f = 1 MHz
						I_R	V_R			
		Min	Nom	Max	Max	μA	@ Volts	Min	Max	
BZX84B27LT1G	T27	26.5	27	27.5	80	0.05	18.9	21.4	25.3	70

*Includes SZ-prefix devices where applicable.

BZX84BxxxLT1G, BZX84CxxxLT1G Series, SZBZX84BxxxLT1G, SZBZX84CxxxLT1G Series

TYPICAL CHARACTERISTICS



Figure 1. Temperature Coefficients (Temperature Range -55°C to +150°C)



Figure 2. Temperature Coefficients (Temperature Range -55°C to +150°C)



Figure 3. Effect of Zener Voltage on Zener Impedance



Figure 4. Typical Forward Voltage

BZX84BxxxLT1G, BZX84CxxxLT1G Series, SZBZX84BxxxLT1G, SZBZX84CxxxLT1G Series

TYPICAL CHARACTERISTICS



Figure 5. Typical Capacitance



Figure 6. Typical Leakage Current



Figure 7. Zener Voltage versus Zener Current (V_Z Up to 12 V)



Figure 8. Zener Voltage versus Zener Current (12 V to 91 V)

BZX84BxxxLT1G, BZX84CxxxLT1G Series, SZBZX84BxxxLT1G, SZBZX84CxxxLT1G Series

PACKAGE DIMENSIONS

SOT-23 (TO-236)

CASE 318-08

ISSUE AR

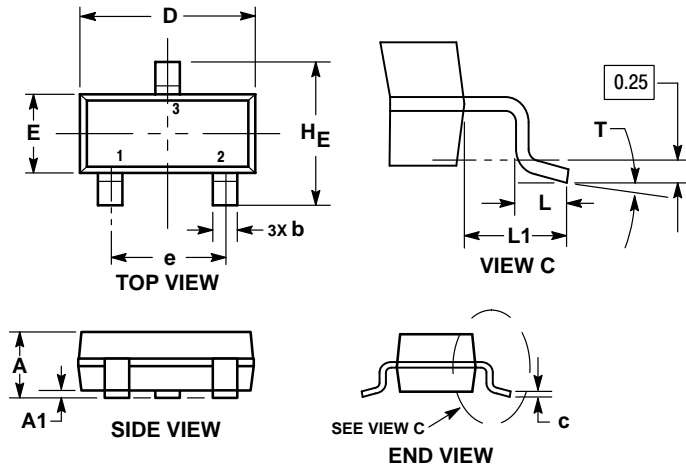

NOTES:

1. DIMENSIONING AND TOLERANCING PER ASME Y14.5M, 1994.
2. CONTROLLING DIMENSION: MILLIMETERS.
3. MAXIMUM LEAD THICKNESS INCLUDES LEAD FINISH. MINIMUM LEAD THICKNESS IS THE MINIMUM THICKNESS OF THE BASE MATERIAL.
4. DIMENSIONS D AND E DO NOT INCLUDE MOLD FLASH, PROTRUSIONS, OR GATE BURRS.

DIM	MILLIMETERS			INCHES		
	MIN	NOM	MAX	MIN	NOM	MAX
A	0.89	1.00	1.11	0.035	0.039	0.044
A1	0.01	0.06	0.10	0.000	0.002	0.004
b	0.37	0.44	0.50	0.015	0.017	0.020
c	0.08	0.14	0.20	0.003	0.006	0.008
D	2.80	2.90	3.04	0.110	0.114	0.120
E	1.20	1.30	1.40	0.047	0.051	0.055
e	1.78	1.90	2.04	0.070	0.075	0.080
L	0.30	0.43	0.55	0.012	0.017	0.022
L1	0.35	0.54	0.69	0.014	0.021	0.027
HE	2.10	2.40	2.64	0.083	0.094	0.104
T	0°	---	10°	0°	---	10°

STYLE 8:

1. ANODE
2. NO CONNECTION
3. CATHODE

RECOMMENDED SOLDERING FOOTPRINT



ON Semiconductor and are trademarks of Semiconductor Components Industries, LLC dba ON Semiconductor or its subsidiaries in the United States and/or other countries. ON Semiconductor owns the rights to a number of patents, trademarks, copyrights, trade secrets, and other intellectual property. A listing of ON Semiconductor's product/patent coverage may be accessed at www.onsemi.com/site/pdf/Patent-Marking.pdf. ON Semiconductor reserves the right to make changes without further notice to any products herein. ON Semiconductor makes no warranty, representation or guarantee regarding the suitability of its products for any particular purpose, nor does ON Semiconductor assume any liability arising out of the application or use of any product or circuit, and specifically disclaims any and all liability, including without limitation special, consequential or incidental damages. Buyer is responsible for its products and applications using ON Semiconductor products, including compliance with all laws, regulations and safety requirements or standards, regardless of any support or applications information provided by ON Semiconductor. "Typical" parameters which may be provided in ON Semiconductor data sheets and/or specifications can and do vary in different applications and actual performance may vary over time. All operating parameters, including "Typicals" must be validated for each customer application by customer's technical experts. ON Semiconductor does not convey any license under its patent rights nor the rights of others. ON Semiconductor products are not designed, intended, or authorized for use as a critical component in life support systems or any FDA Class 3 medical devices or medical devices with a same or similar classification in a foreign jurisdiction or any devices intended for implantation in the human body. Should Buyer purchase or use ON Semiconductor products for any such unintended or unauthorized application, Buyer shall indemnify and hold ON Semiconductor and its officers, employees, subsidiaries, affiliates, and distributors harmless against all claims, costs, damages, and expenses, and reasonable attorney fees arising out of, directly or indirectly, any claim of personal injury or death associated with such unintended or unauthorized use, even if such claim alleges that ON Semiconductor was negligent regarding the design or manufacture of the part. ON Semiconductor is an Equal Opportunity/Affirmative Action Employer. This literature is subject to all applicable copyright laws and is not for resale in any manner.

PUBLICATION ORDERING INFORMATION

LITERATURE FULFILLMENT:

Literature Distribution Center for ON Semiconductor
 P.O. Box 5163, Denver, Colorado 80217 USA
Phone: 303-675-2175 or 800-344-3860 Toll Free USA/Canada
Fax: 303-675-2176 or 800-344-3867 Toll Free USA/Canada
Email: orderlit@onsemi.com

N. American Technical Support: 800-282-9855 Toll Free
 USA/Canada
Europe, Middle East and Africa Technical Support:
 Phone: 421 33 790 2910
Japan Customer Focus Center
 Phone: 81-3-5817-1050

ON Semiconductor Website: www.onsemi.com

Order Literature: <http://www.onsemi.com/orderlit>

For additional information, please contact your local Sales Representative

Looking for pricing, stock, or lifecycle information?

Click below to explore more details on WIN SOURCE:

 [View BZX84C36LT1G on WIN SOURCE](#)

 [ON Semiconductor](#) Information

Optimize Your Supply Chain with WIN SOURCE Solutions

-  Global Sourcing Solution
-  Obsolete Management
-  Cost Control Management
-  Shortage Management
-  Alternative Solution
-  Excess Inventory Management