



**THE DATASHEET OF
LTM8026IY**



36V_{IN}, 5A CVCC Step-Down μModule Regulator

FEATURES

- Complete Step-Down Switch Mode Power Supply
- Constant-Voltage Constant-Current Operation
- Selectable Output Current Up to 5A
- Parallelable for Increased Output Current, Even from Different Voltage Sources
- Wide Input Voltage Range: 6V to 36V
- 1.2V to 24V Output Voltage
- Selectable Switching Frequency: 100kHz to 1MHz
- SnPb or RoHS Compliant Finish
- Programmable Soft-Start
- (11.25mm × 15mm × 2.82mm) LGA and (11.25mm × 15mm × 3.42mm) BGA Packages

APPLICATIONS

- SuperCap Charging
- General Purpose Industrial
- Extreme Short-Circuit Protection or Accurate Output Current Limit
- μController-Based Battery Charging
- High Power LED Drive
- Multiple Input, Single Output Voltage Conversion

DESCRIPTION

The LTM[®]8026 is a 36V_{IN}, 5A constant-voltage, constant-current (CVCC) step-down μModule[®] regulator. Included in the package are the switching controller, power switches, inductor and support components. Operating over an input voltage range of 6V to 36V, the LTM8026 supports an output voltage range of 1.2V to 24V. CVCC operation allows the LTM8026 to accurately regulate its output current up to 5A over the entire output range. The output current can be set by a control voltage, a single resistor or a thermistor. Only resistors to set the output voltage and frequency and the bulk input and output filter capacitors are needed to finish the design.

The LTM8026 is packaged in a thermally-enhanced, compact (11.25mm × 15mm) overmolded land grid array (LGA) and ball grid array (BGA) packages suitable for automated assembly by standard surface mount equipment. The LTM8026 is available in SnPb (BGA) or RoHS compliant terminal finish.

LT, LT, LTC, LTM, μModule, Linear Technology and the Linear logo are registered trademarks of Analog Devices Inc. All other trademarks are the property of their respective owners. Protected by U.S. Patents including 7199560, 7321203 and others pending.

TYPICAL APPLICATION

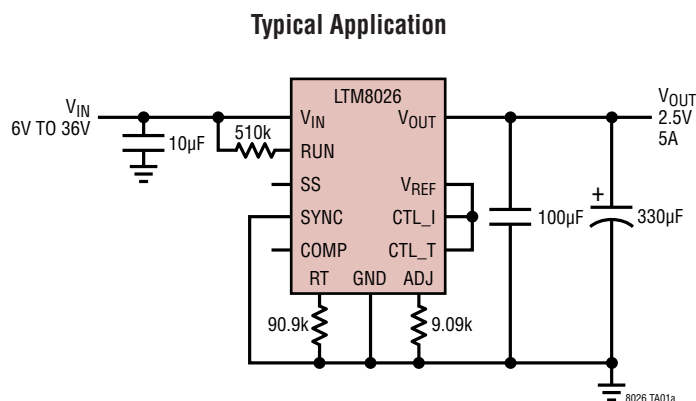

V_{OUT} vs I_{OUT}, 12V_{IN}

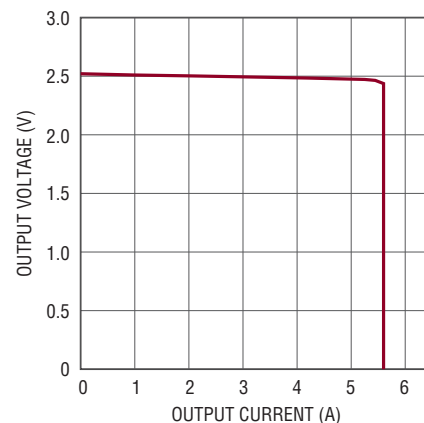

8026 TA01b

LTM8026

ABSOLUTE MAXIMUM RATINGS

(Note 1)

V_{IN}	40V	Current Into RUN Pin	100 μ A
ADJ, RT, COMP, CTL_I, CTL_T, V_{REF}	3V	Internal Operating Temperature Range ..	-40°C to 125°C
V_{OUT}	25V	Peak Solder Reflow Body Temperature	245°C
RUN, SYNC, SS.....	6V	Storage Temperature.....	-55°C to 125°C

PIN CONFIGURATION <http://www.linear.com/product/LTM8026#orderinfo>

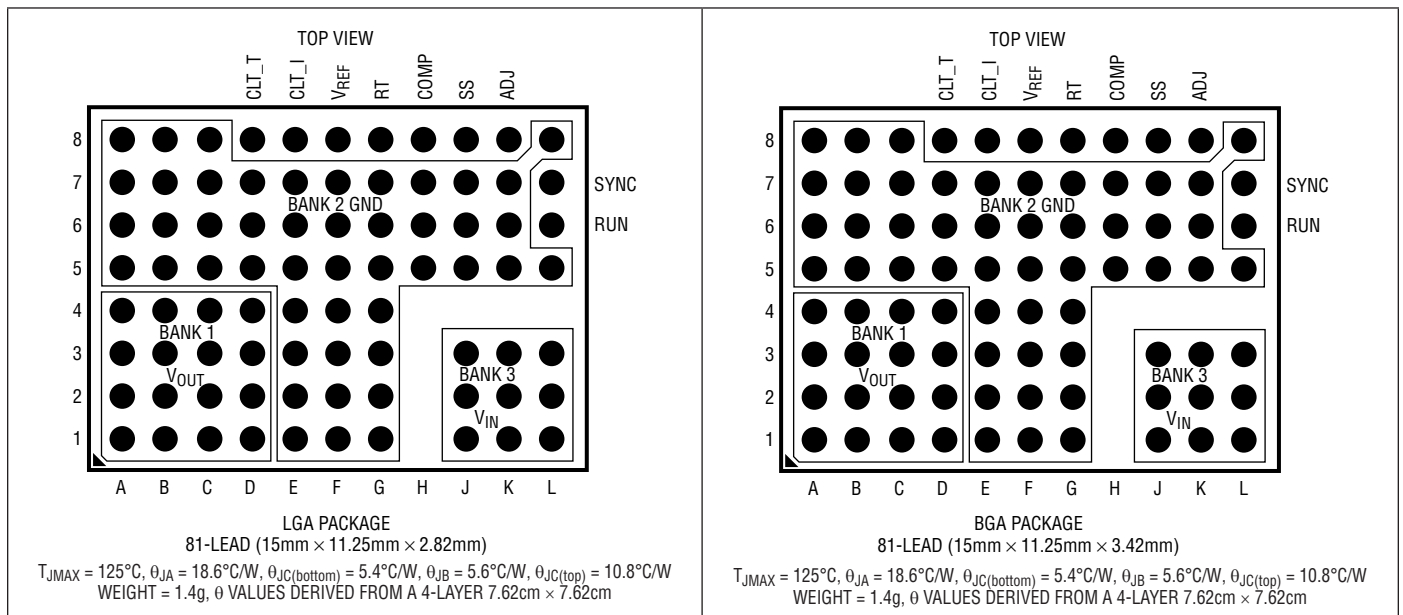

ORDER INFORMATION

PART NUMBER	PAD OR BALL FINISH	PART MARKING*		PACKAGE TYPE	MSL RATING	TEMPERATURE RANGE (Note 2)
		DEVICE	FINISH CODE			
LTM8026EV#PBF	Au (RoHS)	LTM8026V	e4	LGA	3	-40°C to 125°C
LTM8026IV#PBF	Au (RoHS)	LTM8026V	e4	LGA	3	-40°C to 125°C
LTM8026MPV#PBF	Au (RoHS)	LTM8026V	e4	LGA	3	-55°C to 125°C
LTM8026EY#PBF	SAC305 (RoHS)	LTM8026Y	e1	BGA	3	-40°C to 125°C
LTM8026IY#PBF	SAC305 (RoHS)	LTM8026Y	e1	BGA	3	-40°C to 125°C
LTM8026IY	SnPb (63/37)	LTM8026Y	e0	BGA	3	-40°C to 125°C
LTM8026MPY#PBF	SAC305 (RoHS)	LTM8026Y	e1	BGA	3	-55°C to 125°C
LTM8026MPY	SnPb (63/37)	LTM8026Y	e0	BGA	3	-55°C to 125°C

Consult Marketing for parts specified with wider operating temperature ranges. *Device temperature grade is indicated by a label on the shipping container. Pad or ball finish code is per IPC/JEDEC J-STD-609.

• Terminal Finish Part Marking:
www.linear.com/leadfree

• Recommended LGA and BGA PCB Assembly and Manufacturing Procedures:

www.linear.com/umodule/pcbassembly

• LGA and BGA Package and Tray Drawings:

www.linear.com/packaging

ELECTRICAL CHARACTERISTICS

The ● denotes the specifications which apply over the full internal operating temperature range, otherwise specifications are at $T_A = 25^\circ\text{C}$. $R_{UN} = 3\text{V}$, unless otherwise noted. (Note 3)

PARAMETER	CONDITIONS		MIN	TYP	MAX	UNITS
Minimum Input Voltage		●			6	V
Output DC Voltage	$I_{OUT} = 1\text{A}$, R_{ADJ} Open			1.2		V
	$I_{OUT} = 1\text{A}$, $R_{ADJ} = 499\Omega$			24		V
Output DC Current	$6\text{V} < V_{IN} < 36\text{V}$, $V_{OUT} = 3.3\text{V}$		0		5	A
Quiescent Current Into V_{IN}	$R_{UN} = 0\text{V}$ No Load			0.1 2	3 4	μA mA
Line Regulation	$6\text{V} < V_{IN} < 36\text{V}$, $I_{OUT} = 1\text{A}$			0.1		%
Load Regulation	$V_{IN} = 12\text{V}$, $0\text{A} < I_{OUT} < 5\text{A}$			0.7		%
Output RMS Voltage Ripple	$V_{IN} = 12\text{V}$, $I_{OUT} = 4.5\text{A}$			10		mV
Switching Frequency	$R_T = 40.2\text{k}$ $R_T = 453\text{k}$			1000 100		kHz kHz
Voltage at ADJ Pin		●	1.16	1.19	1.22	V
Current Out of ADJ Pin	$ADJ = 0\text{V}$, $V_{OUT} = 1\text{V}$			100		μA
RUN Pin Current	$R_{UN} = 1.45\text{V}$			5.5		μA
RUN Threshold Voltage (Falling)			1.47	1.55	1.63	V
RUN Input Hysteresis				130		mV
CTL_I Control Range			0		1.5	V
CTL_I Pin Current					1.5	μA
CTL_I Current Limit Accuracy	$CTL_I = 1.5\text{V}$ $CTL_I = 0.75\text{V}$		5.1 2.24	5.6 2.8	6.1 3.36	A A
CTL_T Control Range			0		1.5	V
CTL_T Pin Current					1.5	μA
CTL_T Current Limit Accuracy	$CTL_T = 1.5\text{V}$ $CTL_T = 0.75\text{V}$		5.1 2.24	5.6 2.8	6.1 3.36	A A
V_{REF} Voltage	0.5mA Load		1.89		2.04	V
SS Pin Current	(Note 4)			-11		μA
SYNC Input Low Threshold	$f_{SYNC} = 400\text{kHz}$				0.6	V
SYNC Input High Threshold	$f_{SYNC} = 400\text{kHz}$		1.2			V
SYNC Bias Current	$SYNC = 0\text{V}$				1	μA

Note 1: Stresses beyond those listed under Absolute Maximum Ratings may cause permanent damage to the device. Exposure to any Absolute Maximum Rating condition for extended periods may affect device reliability and lifetime.

Note 2: This μModule regulator includes overtemperature protection that is intended to protect the device during momentary overload conditions. Internal temperature will exceed 125°C when overtemperature protection is active. Continuous operation above the specified maximum internal operating junction temperature may impair device reliability.

Note 3: The LTM8026E is guaranteed to meet performance specifications from 0°C to 125°C internal operating temperature. Specifications over the full -40°C to 125°C internal operating temperature range are assured by design, characterization and correlation with statistical process controls. The LTM8026I is guaranteed to meet specifications over the full -40°C to 125°C internal operating temperature range. The LTM8026MP is guaranteed to meet specifications over the full -55°C to 125°C internal operating temperature range. Note that the maximum internal temperature is determined by specific operating conditions in conjunction with board layout, the rated package thermal resistance and other environmental factors.

Note 4: Current flows out of pin.

TYPICAL PERFORMANCE CHARACTERISTICS

$T_A = 25^\circ\text{C}$, unless otherwise noted. Configured per Table 1, where applicable.

1.2V_{OUT} Efficiency vs Output Current

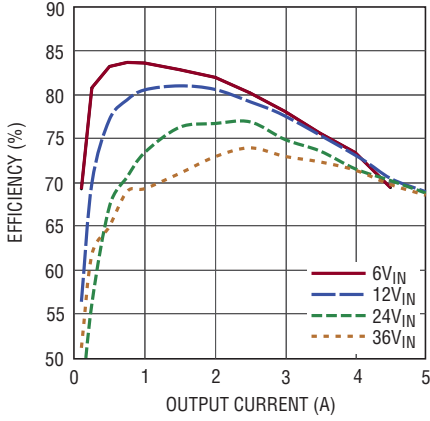

8026 G01

1.5V_{OUT} Efficiency vs Output Current

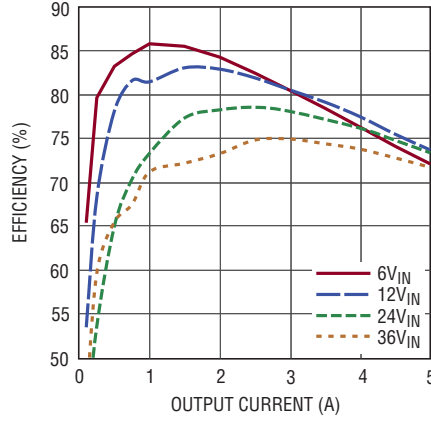

8026 G02

1.8V_{OUT} Efficiency vs Output Current

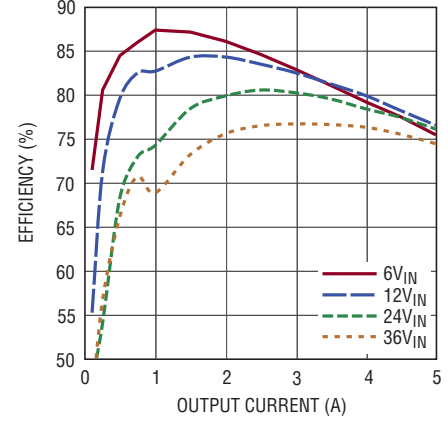

8026 G03

2.5V_{OUT} Efficiency vs Output Current

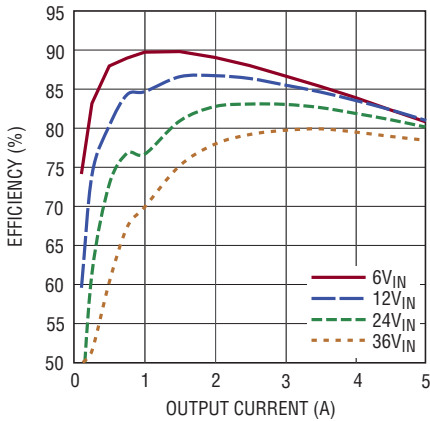

8026 G04

3.3V_{OUT} Efficiency vs Output Current

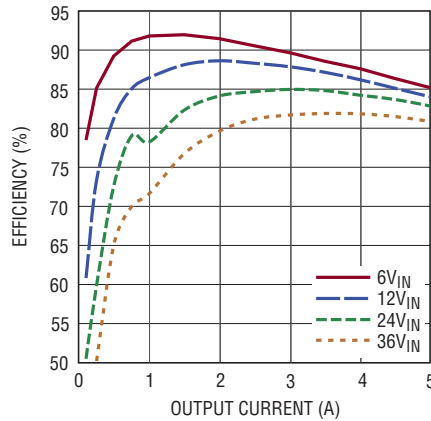

8026 G05

5V_{OUT} Efficiency vs Output Current

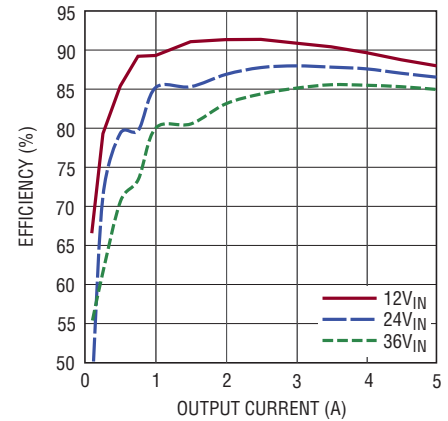

8026 G06

8V_{OUT} Efficiency vs Output Current

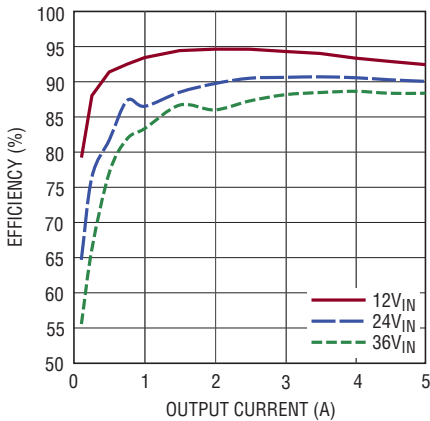

8026 G07

12V_{OUT} Efficiency vs Output Current

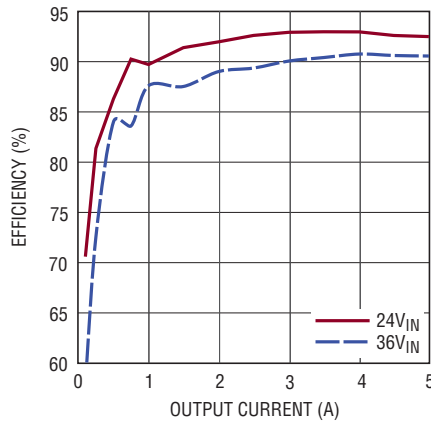

8026 G08

18V_{OUT} Efficiency vs Output Current

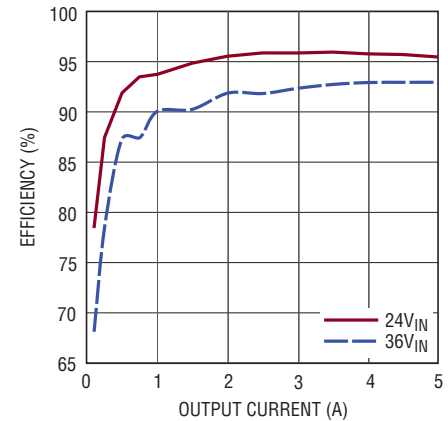

8026 G09

TYPICAL PERFORMANCE CHARACTERISTICS $T_A = 25^\circ\text{C}$, unless otherwise noted.
 $T_A = 25^\circ\text{C}$, unless otherwise noted. Configured per Table 1, where applicable.

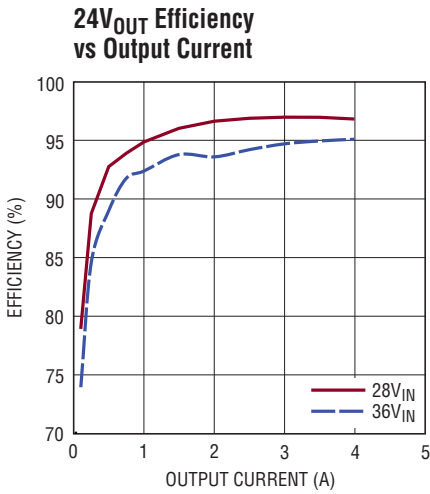

8026 G10

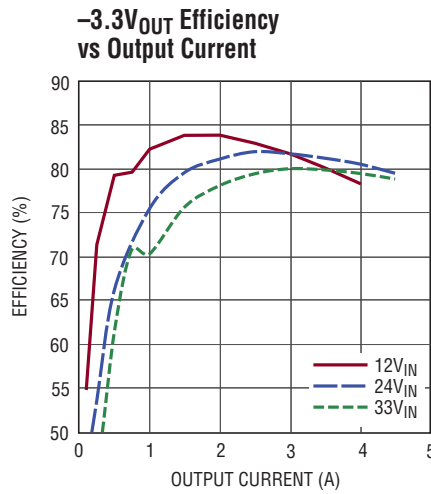

8026 G11

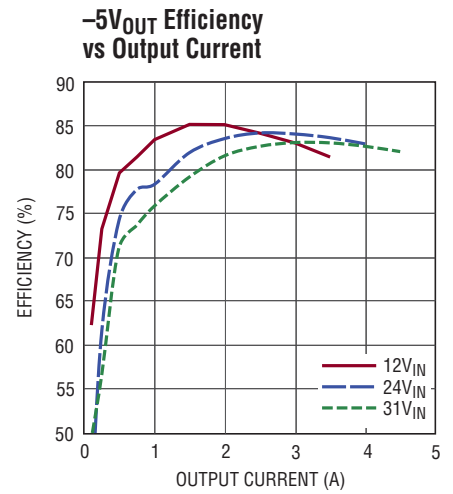

8026 G12

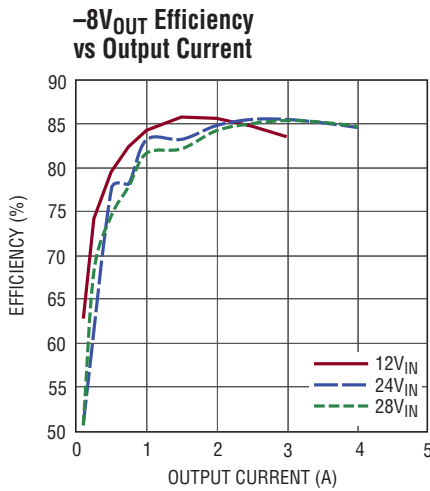

8026 G13

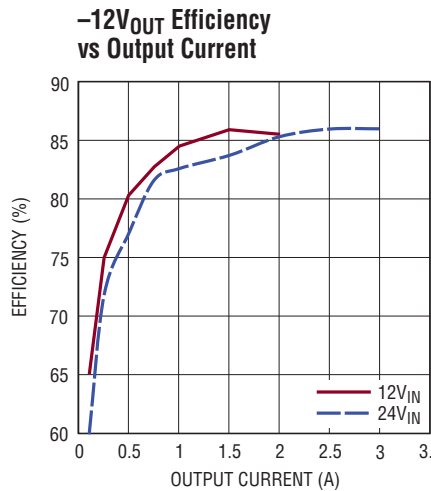

8026 G14

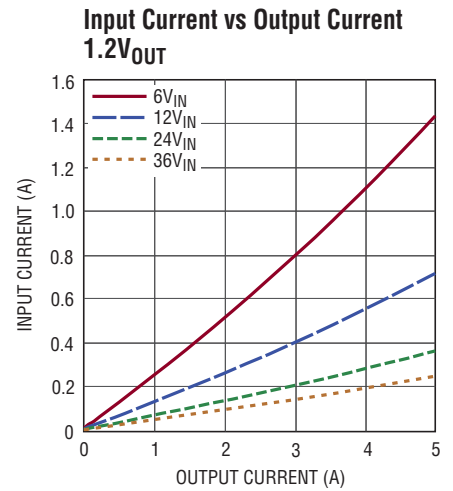

8026 G15

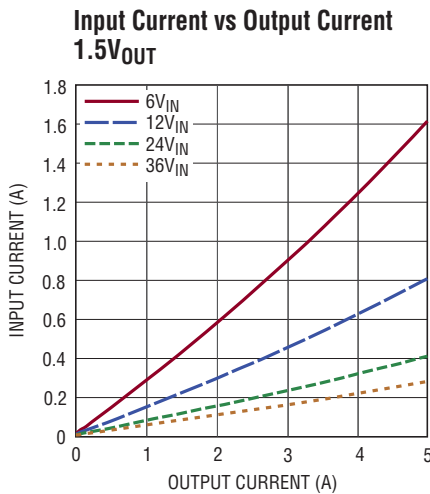

8026 G16

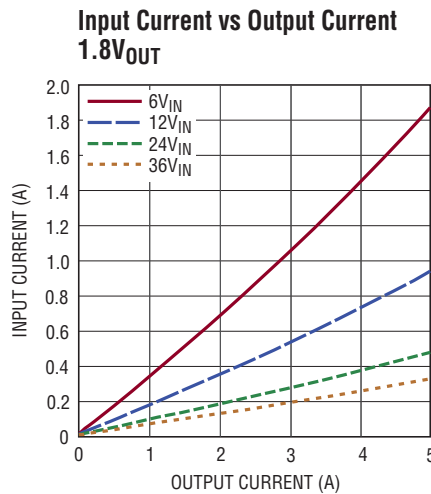

8026 G17

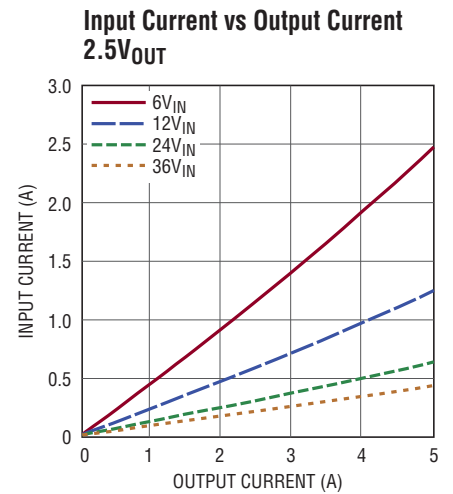

8026 G18

TYPICAL PERFORMANCE CHARACTERISTICS

$T_A = 25^\circ\text{C}$, unless otherwise noted. Configured per Table 1, where applicable.

**Input Current vs Output Current
3.3V_{OUT}**

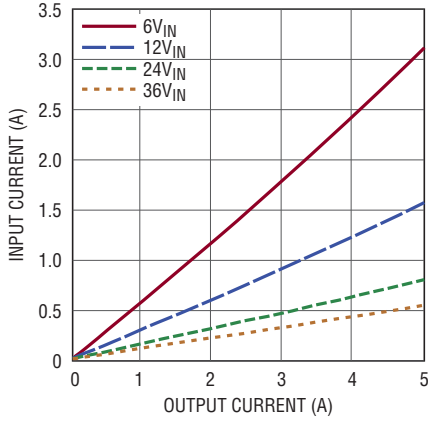

8026 G19

**Input Current vs Output Current
5V_{OUT}**

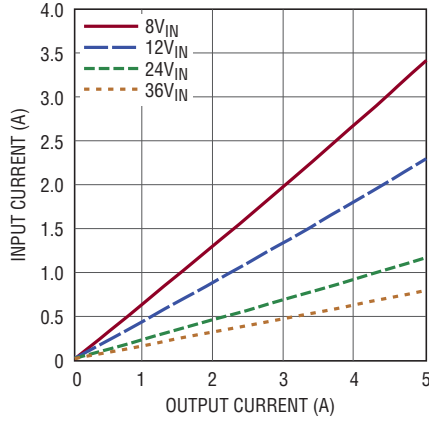

8026 G20

**Input Current vs Output Current
8V_{OUT}**

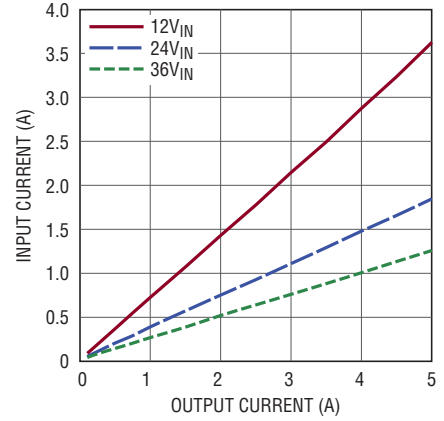

8026 G21

**Input Current vs Output Current
12V_{OUT}**

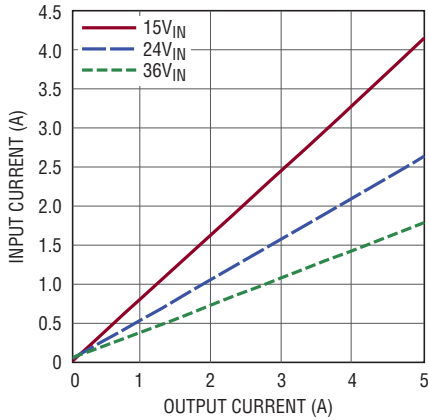

8026 G22

**Input Current vs Output Current
18V_{OUT}**

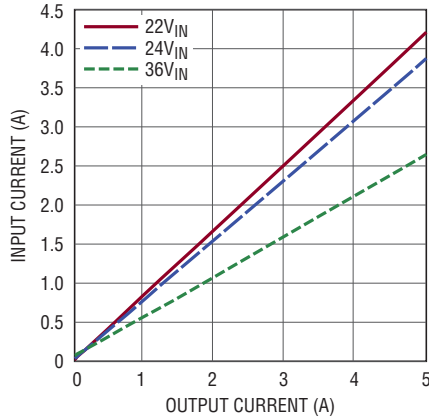

8026 G23

**Input Current vs Output Current
24V_{OUT}**

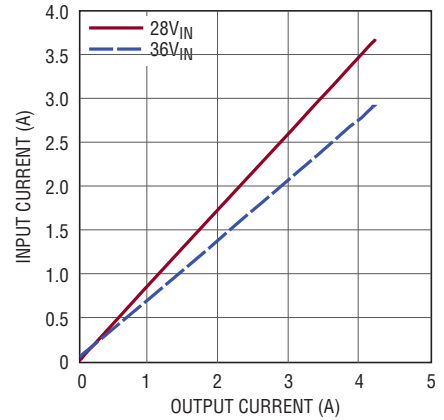

8026 G24

**Input Current vs Input Voltage
(Output Shorted)**

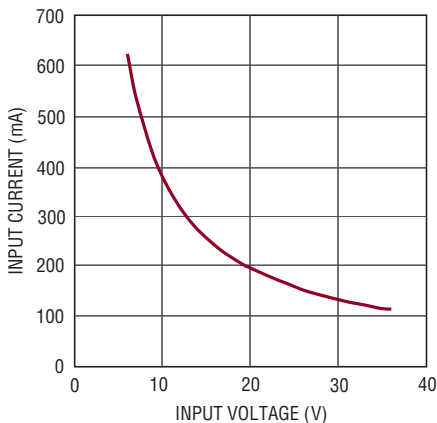

8026 G25

**Input Current vs Load Current
-3.3V_{OUT}**

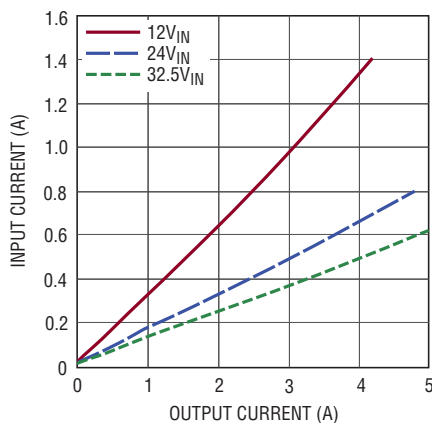

8026 G26

**Input Current vs Load Current
-5V_{OUT}**

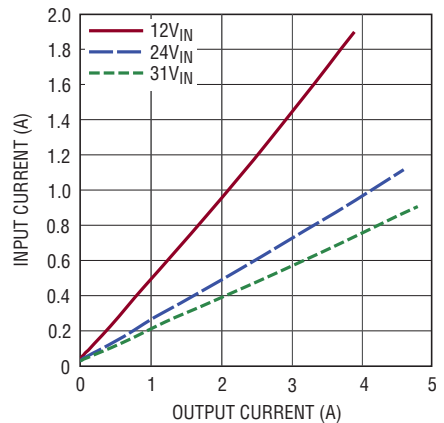

8026 G27

TYPICAL PERFORMANCE CHARACTERISTICS

$T_A = 25^\circ\text{C}$, unless otherwise noted. Configured per Table 1, where applicable.

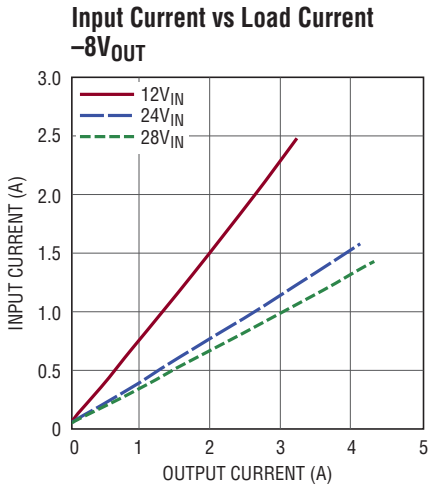

8026 G28

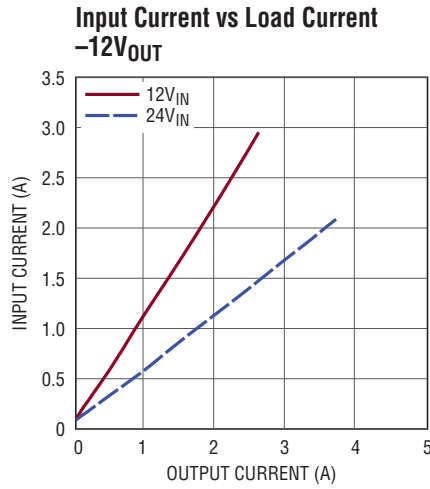

8026 G29

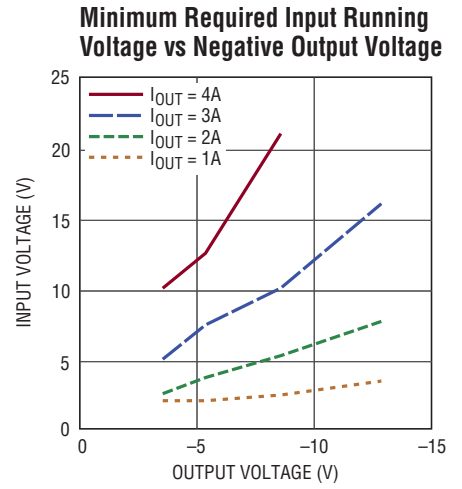

8026 G30



8026 G31

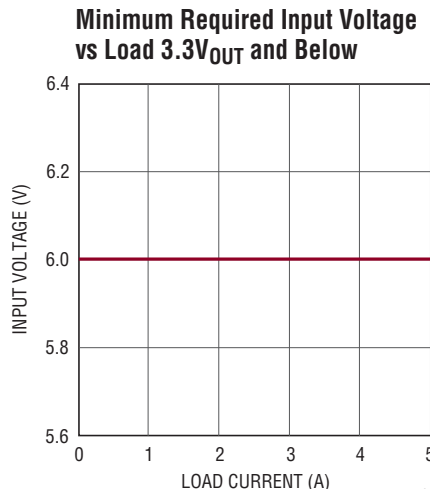

8026 G32

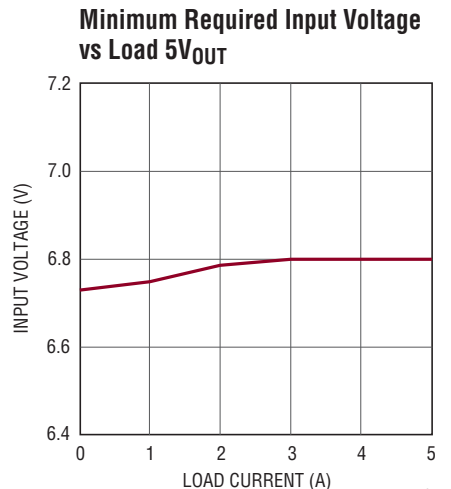

8026 G33

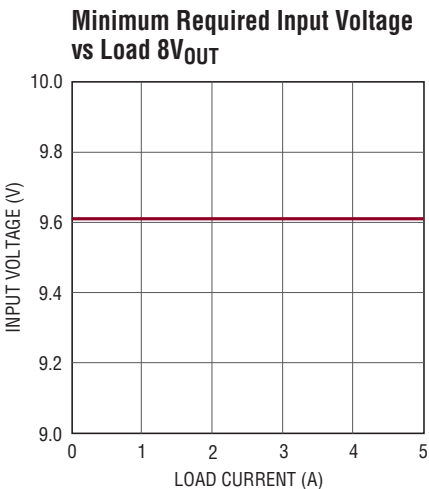

8026 G34

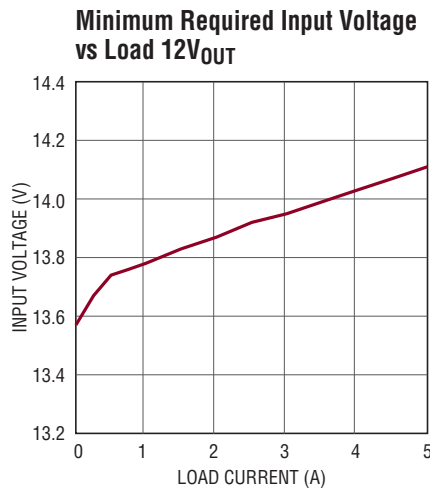

8026 G35

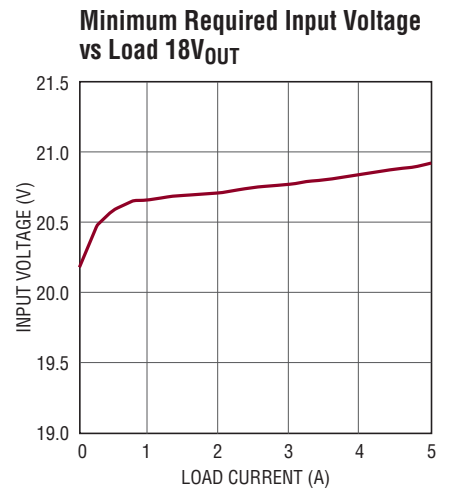

8026 G36

TYPICAL PERFORMANCE CHARACTERISTICS

$T_A = 25^\circ\text{C}$, unless otherwise noted. Configured per Table 1, where applicable.

Minimum Required Input Voltage vs Load $24V_{OUT}$

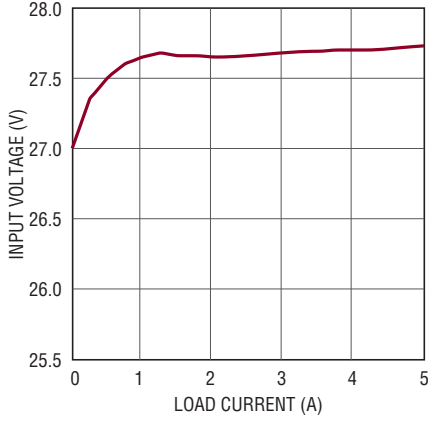

8026 G37

Minimum Required Input Voltage vs Load $-3.3V_{OUT}$

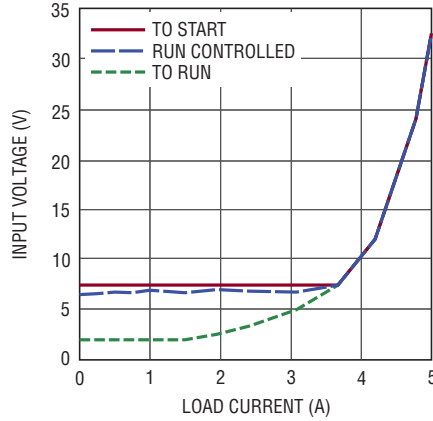

8026 G38

Minimum Required Input Voltage vs Load $-5V_{OUT}$

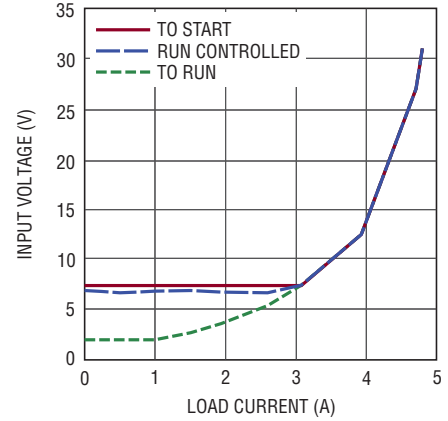

8026 G39

Minimum Required Input Voltage vs Load $-8V_{OUT}$

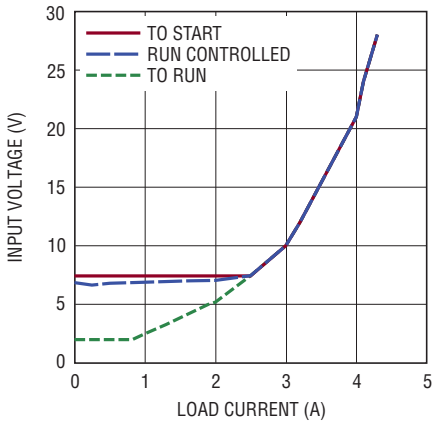

8026 G40

Minimum Required Input Voltage vs Load $-12V_{OUT}$

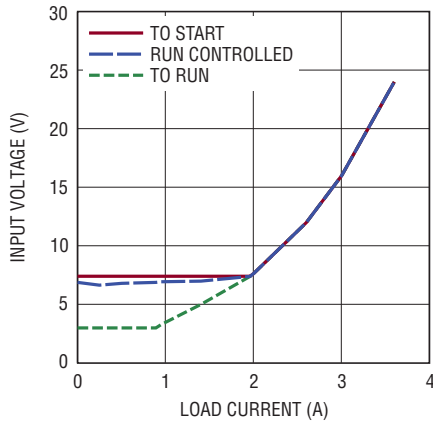

8026 G41

Temperature Rise vs Load Current $2.5V_{OUT}$

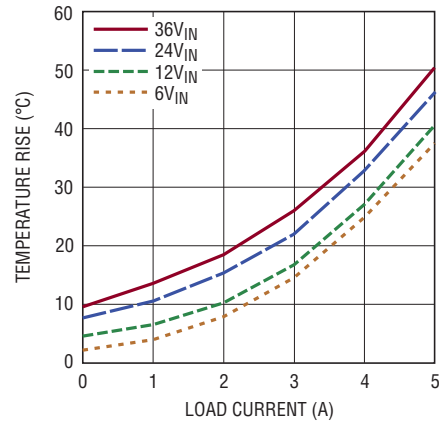

8026 G42

Temperature Rise vs Load Current $3.3V_{OUT}$

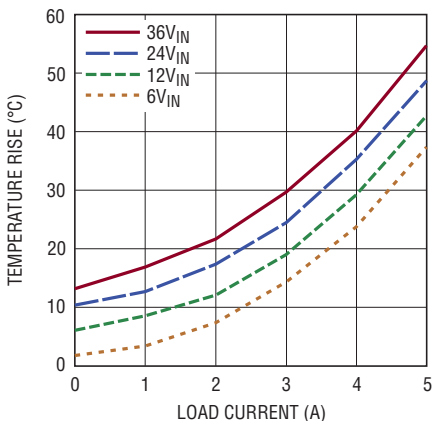

8026 G43

Temperature Rise vs Load Current $5V_{OUT}$

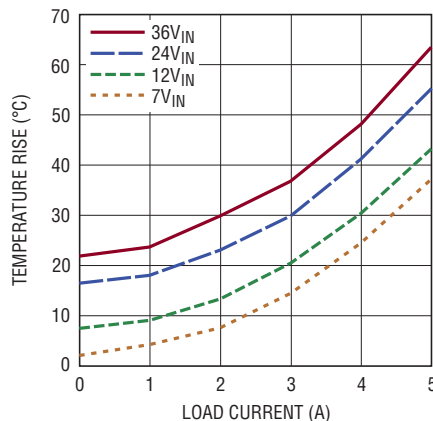

8026 G44

Temperature Rise vs Load Current $8V_{OUT}$

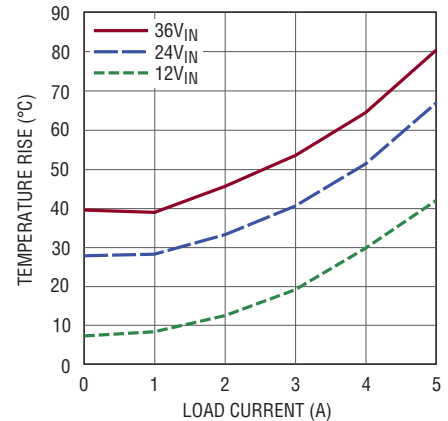

8026 G45

TYPICAL PERFORMANCE CHARACTERISTICS

$T_A = 25^\circ\text{C}$, unless otherwise noted. Configured per Table 1, where applicable.

**Temperature Rise vs Load Current
12V_{OUT}**

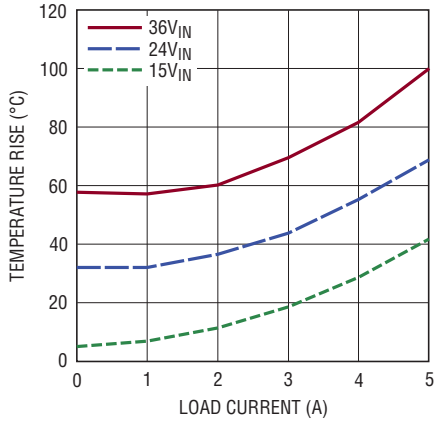

8026 G46

**Temperature Rise vs Load Current
18V_{OUT}**

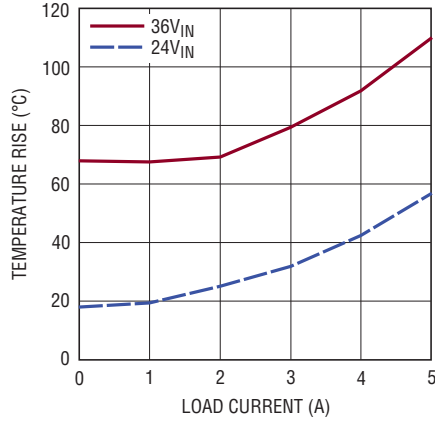

8026 G47

**Temperature Rise vs Load Current
24V_{OUT}**

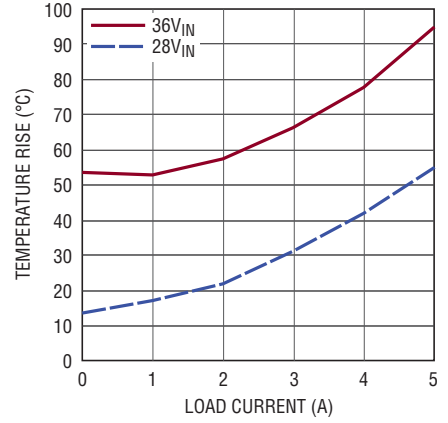

8026 G48

**Temperature Rise vs Load Current
-3.3V_{OUT}**

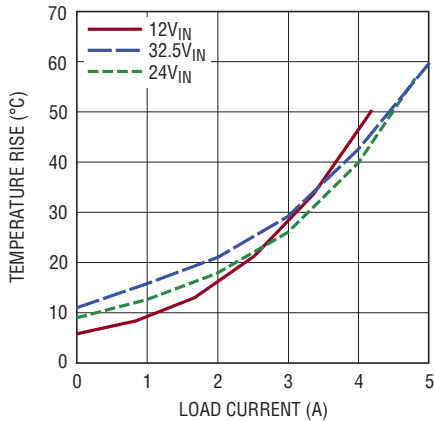

8026 G49

**Temperature Rise vs Load Current
-5V_{OUT}**

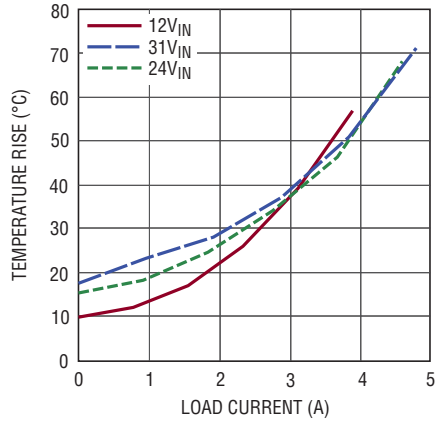

8026 G50

**Temperature Rise vs Load Current
-8V_{OUT}**

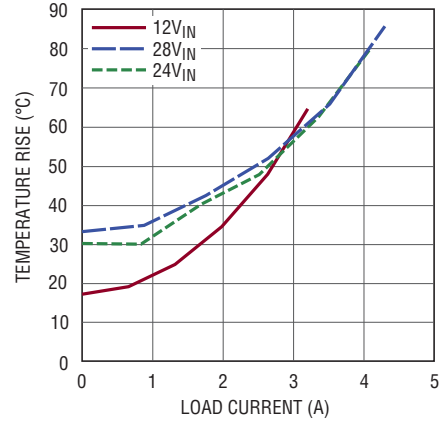

8026 G51

**Temperature Rise vs Load Current
-12V_{OUT}**

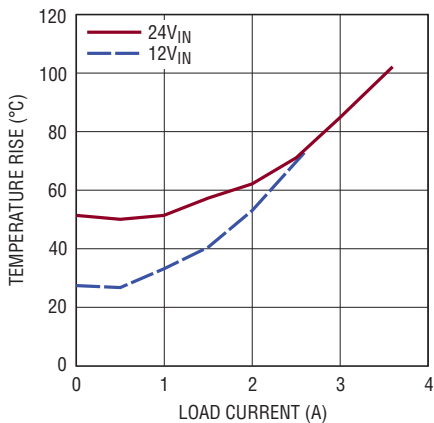

8026 G52

Switching Frequency vs R_T Value

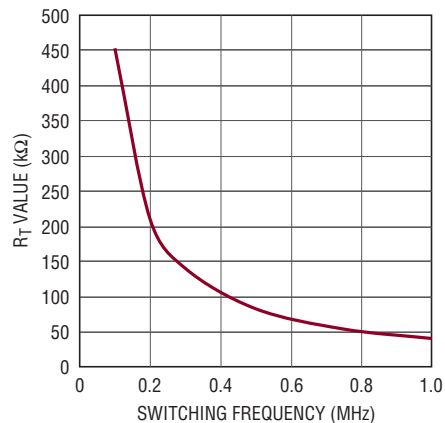

8026 G53

TYPICAL PERFORMANCE CHARACTERISTICS

$T_A = 25^\circ\text{C}$, unless otherwise noted. Configured per Table 1, where applicable.

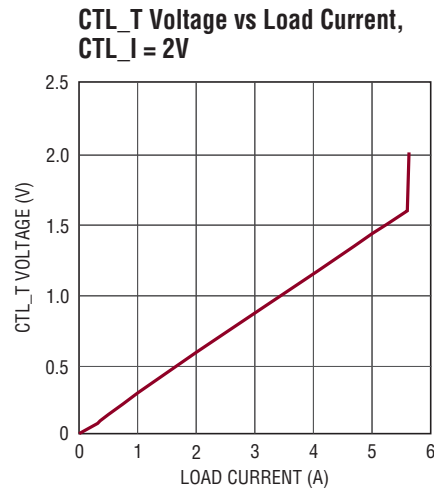
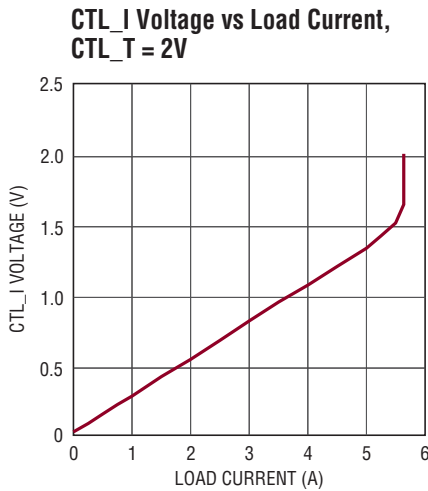

PIN FUNCTIONS

V_{OUT} (Bank 1): Power Output Pins. Apply the output filter capacitor and the output load between these pins and GND pins.

GND (Bank 2): Tie these GND pins to a local ground plane below the LTM8026 and the circuit components. In most applications, the bulk of the heat flow out of the LTM8026 is through these pads, so the printed circuit design has a large impact on the thermal performance of the part. See the PCB Layout and Thermal Considerations sections for more details. Return the feedback divider (R_{ADJ}) to this net.

V_{IN} (Bank 3): The V_{IN} pins supply current to the LTM8026's internal regulator and to the internal power switches. These pins must be locally bypassed with an external, low ESR capacitor; see Table 1 for recommended values.

CTL_T (Pin D8): Connect a resistor/NTC thermistor network to the CTL_T pin to reduce the maximum regulated output current of the LTM8026 in response to temperature. The maximum control voltage is 1.5V. If this function is not used, tie this pin to V_{REF}.

CTL_I (Pin E8): The CTL_I pin reduces the maximum regulated output current of the LTM8026. The maximum control voltage is 1.5V. If this function is not used, tie this pin to V_{REF}.

V_{REF} (Pin F8): Buffered 2V Reference Capable of 0.5mA Drive.

RT (Pin G8): The RT pin is used to program the switching frequency of the LTM8026 by connecting a resistor from this pin to ground. The Applications Information section of the data sheet includes a table to determine the resistance value based on the desired switching frequency. When using the SYNC function, apply a resistor value equivalent to 20% lower than the SYNC pulse frequency. Do not leave this pin open.

COMP (Pin H8): Compensation Pin. This pin is generally not used. The LTM8026 is internally compensated, but some rare situations may arise that require a modification to the control loop. This pin connects directly to the PWM comparator of the LTM8026. In most cases, no adjustment is necessary. If this function is not used, leave this pin open.

PIN FUNCTIONS

SS (Pin J8): The Soft-Start Pin. Place an external capacitor to ground to limit the regulated current during start-up conditions. The soft-start pin has an 11 μ A charging current.

ADJ (Pin K8): The LTM8026 regulates its ADJ pin to 1.19V. Connect the adjust resistor from this pin to ground. The value of R_{ADJ} is given by the equation:

$$R_{ADJ} = \frac{11.9}{V_{OUT} - 1.19}$$

where R_{ADJ} is in $k\Omega$.

RUN (Pin L6): The RUN pin acts as an enable pin and turns on the internal circuitry. The RUN pin is internally clamped, so it may be pulled up to a voltage source that is

higher than the absolute maximum voltage of 6V through a resistor, provided the pin current does not exceed 100 μ A. Do not leave this pin open. It may also be used to implement a precision UVLO. See the Applications Information section for details.

SYNC (Pin L7): Frequency Synchronization Pin. This pin allows the switching frequency to be synchronized to an external clock. The R_T resistor should be chosen to operate the internal clock at 20% lower than the SYNC pulse frequency. This pin should be grounded when not in use. Do not leave this pin floating. When laying out the board, avoid noise coupling to or from the SYNC trace. See the Synchronization section in Applications Information.

BLOCK DIAGRAM

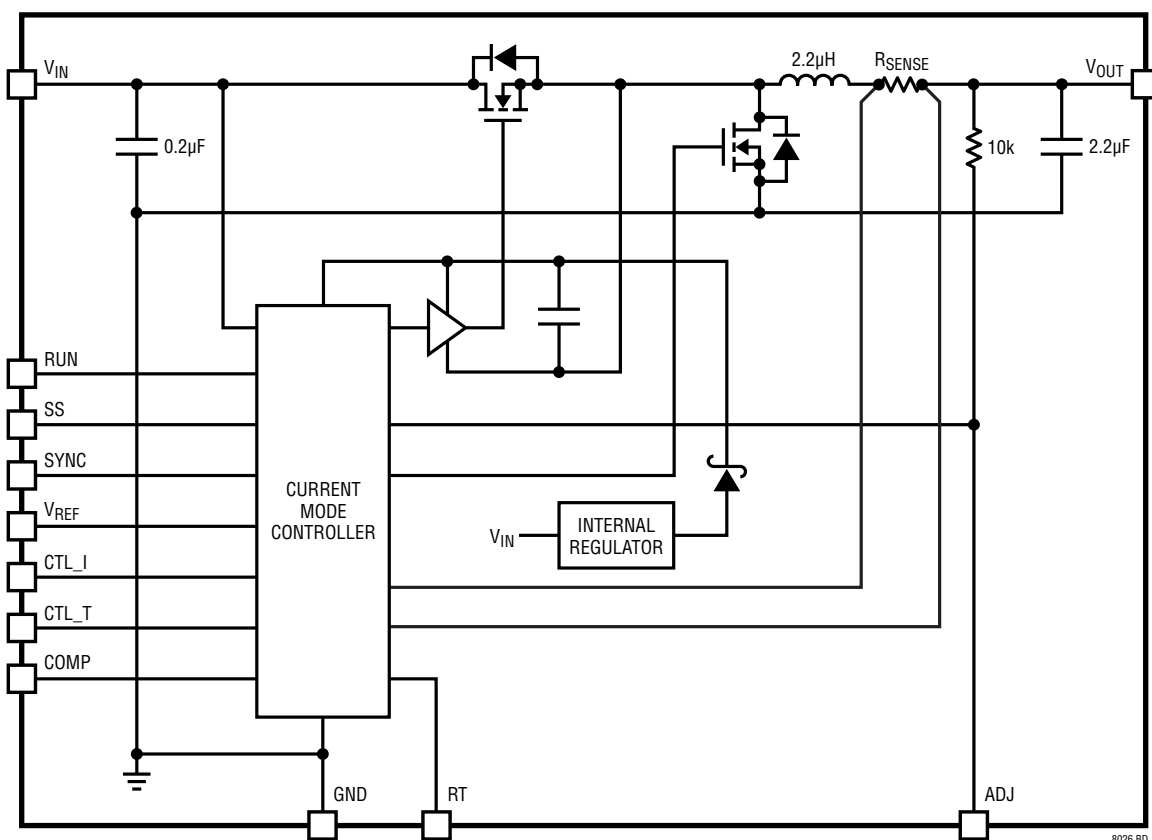

OPERATION

The LTM8026 is a standalone nonisolated step-down switching DC/DC power supply that can deliver up to 5A of output current. This μ Module regulator provides a precisely regulated output voltage programmable via one external resistor from 1.2V to 24V. The input voltage range is 6V to 36V. Given that the LTM8026 is a step-down converter, make sure that the input voltage is high enough to support the desired output voltage and load current.

As shown in the Block Diagram, the LTM8026 contains a current mode controller, power switches, power inductor, and a modest amount of input and output capacitance.

The LTM8026 utilizes fixed frequency, average current mode control to accurately regulate the inductor current, independently from the output voltage. This is an ideal solution for applications requiring a regulated current source. The control loop will regulate the current in the internal inductor. Once the output has reached the regulation voltage determined by the resistor from the ADJ pin to ground, the inductor current will be reduced by the voltage regulation loop.

The current control loop has two reference inputs, determined by the voltage at the analog control pins, CTL_I and CTL_T. CTL_I is typically used to set the maximum allowable current output of the LTM8026, while CTL_T is typically used with a NTC thermistor to reduce the output current in response to temperature. The lower of the two analog voltages on CTL_I and CTL_T determines the regulated output current. The analog control range of both the CTL_I and CTL_T pin is from 0V to 1.5V.

The RUN pin functions as a precision shutdown pin. When the voltage at the RUN pin is lower than 1.55V, switching is terminated. Below the turn-on threshold, the RUN pin sinks 5.5 μ A. This current can be used with a resistor between RUN and V_{IN} to set a hysteresis. During start-up, the SS pin is held low until the part is enabled, after which the capacitor at the soft-start pin is charged with an 11 μ A current source.

The LTM8026 is equipped with a thermal shutdown to protect the device during momentary overload conditions. It is set above the 125°C absolute maximum internal temperature rating to avoid interfering with normal specified operation, so internal device temperatures will exceed the absolute maximum rating when the overtemperature protection is active. So, continuous or repeated activation of the thermal shutdown may impair device reliability. During thermal shutdown, all switching is terminated and the SS pin is driven low.

The switching frequency is determined by a resistor at the RT pin. The LTM8026 may also be synchronized to an external clock through the use of the SYNC pin.

APPLICATIONS INFORMATION

For most applications, the design process is straight forward, summarized as follows:

1. Look at Table 1 and find the row that has the desired input range and output voltage.
2. Apply the recommended C_{IN} , C_{OUT} , R_{ADJ} and R_T values.

While these component combinations have been tested for proper operation, it is incumbent upon the user to verify proper operation over the intended system's line, load and environmental conditions. Bear in mind that the maximum output current is limited by junction temperature, the relationship between the input and output voltage magnitude and polarity and other factors. Please refer to the

Table 1. Recommended Component Values and Configuration.
($T_A = 25^\circ\text{C}$. See Typical Performance Characteristics for Load Conditions)

V_{IN}	V_{OUT}	C_{IN}	C_{OUT} CERAMIC	C_{OUT} ELECTROLYTIC	R_{ADJ}	$f_{OPTIMAL}$	$R_T(OPTIMAL)$	f_{MAX}	$R_T(MIN)$
6V to 36V	1.2	10 μ F, 50V, 1210	100 μ F, 6.3V, 1210	470 μ F, 6.3V, 9m Ω , Chemi-Con, APXF6R3ARA471MH80G	Open	200kHz	210k	250kHz	169k
6V to 36V	1.5	10 μ F, 50V, 1210	100 μ F, 6.3V, 1210	470 μ F, 6.3V, 9m Ω , Chemi-Con, APXF6R3ARA471MH80G	38.3k	300kHz	140k	350kHz	118k
6V to 36V	1.8	10 μ F, 50V, 1210	100 μ F, 6.3V, 1210	470 μ F, 6.3V, 9m Ω , Chemi-Con, APXF6R3ARA471MH80G	19.6k	350kHz	118k	400kHz	102k
6V to 36V	2.5	10 μ F, 50V, 1210	100 μ F, 6.3V, 1210	330 μ F, 4V, 27m Ω , OS-CON, 4SVPC330M	9.09k	450kHz	90.9k	525kHz	78.7k
6V to 36V	3.3	10 μ F, 50V, 1210	100 μ F, 6.3V, 1210	330 μ F, 4V, 27m Ω , OS-CON, 4SVPC330M	5.62k	550kHz	75.0k	625kHz	64.9k
7V to 36V	5	10 μ F, 50V, 1210	100 μ F, 6.3V, 1210	120 μ F, 16V, 27m Ω , OS-CON, 16SVPC120M	3.09k	600kHz	68.1k	700kHz	57.6k
10V to 36V	8	10 μ F, 50V, 1210	100 μ F, 10V, 1210	120 μ F, 16V, 27m Ω , OS-CON, 16SVPC120M	1.74k	625kHz	64.9k	750kHz	53.6k
15V to 36V	12	10 μ F, 50V, 1210	47 μ F, 16V, 1210	120 μ F, 16V, 27m Ω , OS-CON, 16SVPC120M	1.10k	650kHz	61.9k	800kHz	49.9k
22V to 36V	18	10 μ F, 50V, 1210	22 μ F, 25V, 1210	47 μ F, 20V, 45m Ω , OS-CON, 20SVPS47M	604	675kHz	59.0k	900kHz	44.2k
28V to 36V	24	4.7 μ F, 50V, 1210	10 μ F, 50V, 1206	47 μ F, 35V, 30m Ω , OS-CON, 35SVPC47M	523	700kHz	57.6k	1MHz	39.2k
9V to 15V	1.2	10 μ F, 50V, 1210	100 μ F, 6.3V, 1210	470 μ F, 6.3V, 9m Ω , Chemi-Con, APXF6R3ARA471MH80G	Open	200kHz	210k	525kHz	78.7k
9V to 15V	1.5	10 μ F, 50V, 1210	100 μ F, 6.3V, 1210	470 μ F, 6.3V, 9m Ω , Chemi-Con, APXF6R3ARA471MH80G	38.3k	300kHz	140k	650kHz	61.9k
9V to 15V	1.8	10 μ F, 50V, 1210	100 μ F, 6.3V, 1210	470 μ F, 6.3V, 9m Ω , Chemi-Con, APXF6R3ARA471MH80G	19.6k	350kHz	118k	800kHz	49.9k
9V to 15V	2.5	10 μ F, 50V, 1210	100 μ F, 6.3V, 1210	330 μ F, 4V, 27m Ω , OS-CON, 4SVPC330M	9.09k	450kHz	90.9k	1MHz	39.2k
9V to 15V	3.3	10 μ F, 50V, 1210	100 μ F, 6.3V, 1210	330 μ F, 4V, 27m Ω , OS-CON, 4SVPC330M	5.62k	550kHz	75.0k	1MHz	39.2k
9V to 15V	5	10 μ F, 50V, 1210	100 μ F, 6.3V, 1210	120 μ F, 16V, 27m Ω , OS-CON, 16SVPC120M	3.09k	600kHz	68.1k	1MHz	39.2k
10V to 15V	8	10 μ F, 50V, 1210	100 μ F, 10V, 1210	120 μ F, 16V, 27m Ω , OS-CON, 16SVPC120M	1.74k	625kHz	64.9k	1MHz	39.2k
18V to 36V	1.2	10 μ F, 50V, 1210	100 μ F, 6.3V, 1210	470 μ F, 6.3V, 9m Ω , Chemi-Con, APXF6R3ARA471MH80G	Open	200kHz	210k	250kHz	169k
18V to 36V	1.5	10 μ F, 50V, 1210	100 μ F, 6.3V, 1210	470 μ F, 6.3V, 9m Ω , Chemi-Con, APXF6R3ARA471MH80G	38.3k	300kHz	140k	350kHz	118k
18V to 36V	1.8	10 μ F, 50V, 1210	100 μ F, 6.3V, 1210	470 μ F, 6.3V, 9m Ω , Chemi-Con, APXF6R3ARA471MH80G	19.6k	350kHz	118k	400kHz	102k
18V to 36V	2.5	10 μ F, 50V, 1210	100 μ F, 6.3V, 1210	330 μ F, 4V, 27m Ω , OS-CON, 4SVPC330M	9.09k	450kHz	90.9k	525kHz	78.7k
18V to 36V	3.3	10 μ F, 50V, 1210	100 μ F, 6.3V, 1210	330 μ F, 4V, 27m Ω , OS-CON, 4SVPC330M	5.62k	550kHz	75.0k	625kHz	64.9k
18V to 36V	5	10 μ F, 50V, 1210	100 μ F, 6.3V, 1210	120 μ F, 16V, 27m Ω , OS-CON, 16SVPC120M	3.09k	600kHz	68.1k	700kHz	57.6k
18V to 36V	8	10 μ F, 50V, 1210	100 μ F, 10V, 1210	120 μ F, 16V, 27m Ω , OS-CON, 16SVPC120M	1.74k	625kHz	64.9k	750kHz	53.6k
18V to 36V	12	10 μ F, 50V, 1210	47 μ F, 16V, 1210	120 μ F, 16V, 27m Ω , OS-CON, 16SVPC120M	1.10k	650kHz	61.9k	800kHz	49.9k
2.7V to 32.5V*	-3.3	10 μ F, 50V, 1210	100 μ F, 6.3V, 1210	330 μ F, 4V, 27m Ω , OS-CON, 4SVPC330M	5.62k	550kHz	75.0k	625kHz	64.9k
2V to 31V*	-5	10 μ F, 50V, 1210	100 μ F, 6.3V, 1210	120 μ F, 16V, 27m Ω , OS-CON, 16SVPC120M	3.09k	600kHz	68.1k	700kHz	57.6k
2V to 28V*	-8	10 μ F, 50V, 1210	100 μ F, 10V, 1210	120 μ F, 16V, 27m Ω , OS-CON, 16SVPC120M	1.74k	625kHz	64.9k	750kHz	53.6k
3V to 24V*	-12	10 μ F, 50V, 1210	47 μ F, 16V, 1210	120 μ F, 16V, 27m Ω , OS-CON, 16SVPC120M	1.10k	650kHz	61.9k	800kHz	49.9k

*Running voltage. Requires at least 6V_{IN} to start. Note: An input bulk capacitor is required.

APPLICATIONS INFORMATION

graphs in the Typical Performance Characteristics section for guidance.

The maximum frequency (and attendant R_T value) at which the LTM8026 should be allowed to switch is given in Table 1 in the f_{MAX} column, while the recommended frequency (and R_T value) for optimal efficiency over the given input condition is given in the $f_{OPTIMAL}$ column. There are additional conditions that must be satisfied if the synchronization function is used. Please refer to the Switching Frequency Synchronization section for details.

Capacitor Selection Considerations

The C_{IN} and C_{OUT} capacitor values in Table 1 are the minimum recommended values for the associated operating conditions. Applying capacitor values below those indicated in Table 1 is not recommended, and may result in undesirable operation. Using larger values is generally acceptable, and can yield improved dynamic response, if necessary. Again, it is incumbent upon the user to verify proper operation over the intended system's line, load and environmental conditions.

Ceramic capacitors are small, robust and have very low ESR. However, not all ceramic capacitors are suitable. X5R and X7R types are stable over temperature, applied voltage and give dependable service. Other types, including Y5V and Z5U have very large temperature and voltage coefficients of capacitance. In an application circuit they may have only a small fraction of their nominal capacitance resulting in much higher output voltage ripple than expected.

Many of the output capacitances given in Table 1 specify an electrolytic capacitor. Ceramic capacitors may also be used in the application, but it may be necessary to use more of them. Many high value ceramic capacitors have a large voltage coefficient, so the actual capacitance of the component at the desired operating voltage may be only a fraction of the specified value. Also, the very low ESR of ceramic capacitors may necessitate additional capacitors for acceptable stability margin.

A final precaution regarding ceramic capacitors concerns the maximum input voltage rating of the LTM8026. A ceramic input capacitor combined with trace or cable inductance forms a high Q (under damped) tank circuit. If the LTM8026 circuit is plugged into a live supply, the

input voltage can ring to twice its nominal value, possibly exceeding the device's rating. This situation is easily avoided; see the Hot Plugging Safely section.

Programming Switching Frequency

The LTM8026 has an operational switching frequency range between 100kHz and 1MHz. This frequency is programmed with an external resistor from the R_T pin to ground. Do not leave this pin open under any circumstance. See Table 2 for resistor values and the corresponding switching frequencies.

Table 2. R_T Resistor Values and Their Resultant Switching Frequencies

SWITCHING FREQUENCY (MHz)	R_T (k Ω)
1	39.2
0.750	53.6
0.5	82.5
0.3	140
0.2	210
0.1	453

In addition, the Typical Performance Characteristics section contains a graph that shows the switching frequency versus R_T value.

To improve efficiency at light load, the part will enter discontinuous mode.

Switching Frequency Trade-Offs

It is recommended that the user apply the optimal R_T value given in Table 1 for the input and output operating condition. System level or other considerations, however, may necessitate another operating frequency. While the LTM8026 is flexible enough to accommodate a wide range of operating frequencies, a haphazardly chosen one may result in undesirable operation under certain operating or fault conditions. A frequency that is too high can reduce efficiency, generate excessive heat or even damage the LTM8026 in some fault conditions. A frequency that is too low can result in a final design that has too much output ripple or too large of an output capacitor.

Switching Frequency Synchronization

The nominal switching frequency of the LTM8026 is determined by the resistor from the R_T pin to GND and

8026fd

APPLICATIONS INFORMATION

may be set from 100kHz to 1MHz. The internal oscillator may also be synchronized to an external clock through the SYNC pin. The external clock applied to the SYNC pin must have a logic low below 0.6V and a logic high greater than 1.2V. The input frequency must be 20% higher than the frequency determined by the resistor at the RT pin. In general, the duty cycle of the input signal should be greater than 10% and less than 90%. Input signals outside of these specified parameters may cause erratic switching behavior and subharmonic oscillations. The SYNC pin must be tied to GND if the synchronization to an external clock is not required. When SYNC is grounded, the switching frequency is determined by the resistor at the RT pin. At light loads, the LTM8026 will enter discontinuous operation to improve efficiency even while a valid clock signal is applied to the SYNC pin.

Soft-Start

The soft-start function controls the slew rate of the power supply output voltage during start-up. A controlled output voltage ramp minimizes output voltage overshoot, reduces inrush current from the V_{IN} supply, and facilitates supply sequencing. A capacitor connected from the SS pin to GND programs the slew rate. The capacitor is charged from an internal 11 μ A current source to produce a ramped output voltage.

Maximum Output Current Adjust

To adjust the regulated load current, an analog voltage is applied to the CTL_I pin or CTL_T pins. Varying the voltage between 0V and 1.5V adjusts the maximum current between the minimum and the maximum current, 5.6A typical. Graphs of the output current vs CTL_I and CTL_T voltages are given in the Typical Performance Characteristics section. The LTM8026 provides a 2V reference voltage for conveniently applying resistive dividers to set the current limit. The current limit can be set as shown in Figure 1 with the following equation:

$$I_{MAX} = \frac{7.467 \cdot R2}{R1 + R2} \text{ Amps}$$

Load Current Derating Using the CTL_T Pin

In high current applications, derating the maximum current based on operating temperature may prevent damage to the load. In addition, many applications have thermal limitations that will require the regulated current to be reduced based on the load and/or board temperature. To achieve this, the LTM8026 uses the CTL_T pin to reduce the effective regulated current in the load. While CTL_I programs the regulated current in the load, CTL_T can be configured to reduce this regulated current based on the analog voltage at the CTL_T pin. The load/board temperature derating is programmed using a resistor divider with a temperature dependant resistance (Figure 2). When the board/load temperature rises, the CTL_T voltage will decrease. To reduce the regulated current, the CTL_T voltage must be lower than the voltage at the CTL_I pin. CTL_T may be higher than CTL_I, but then it will have no effect.

Voltage Regulation and Output Overvoltage Protection

The LTM8026 uses the ADJ pin to regulate the output voltage and to provide a high speed overvoltage lockout to avoid high voltage conditions. If the output voltage exceeds 125% of the regulated voltage level (1.5V at the ADJ pin), the LTM8026 terminates switching and shuts

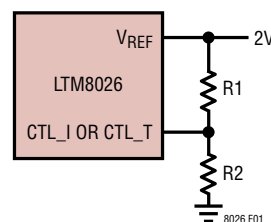

Figure 1. Setting the Output Current Limit, I_{MAX}

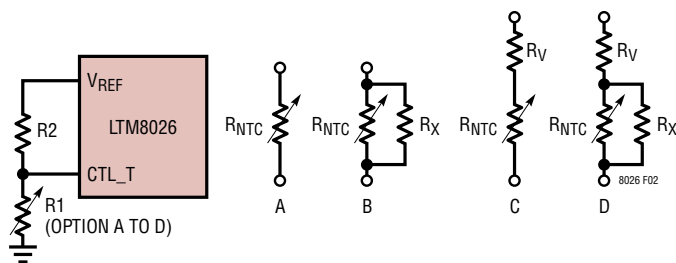

Figure 2. Load Current Derating vs Temperature Using NTC Resistor

APPLICATIONS INFORMATION

down switching for 13 μ s. The regulated output voltage must be greater than 1.21V and is set by the equation:

$$R_{ADJ} = \frac{11.9}{V_{OUT} - 1.19} \text{ k}\Omega$$

where R_{ADJ} is shown in Figure 3.

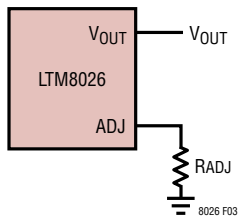

Figure 3. Voltage Regulation and Overvoltage Protection Feedback Connections

Thermal Shutdown

If the part is too hot, the LTM8026 engages its thermal shutdown, terminates switching and discharges the soft-start capacitor. When the part has cooled, the part automatically restarts. This thermal shutdown is set to engage at temperatures above the 125°C absolute maximum internal operating rating to ensure that it does not interfere with functionality in the specified operating range. This means that internal temperatures will exceed the 125°C absolute maximum rating when the overtemperature protection is active, possibly impairing the device's reliability.

Shutdown and UVLO

The LTM8026 has an internal UVLO that terminates switching, resets all logic, and discharges the soft-start capacitor when the input voltage is below 6V. The LTM8026 also has a precision RUN function that enables switching when the voltage at the RUN pin rises to 1.68V and shuts down the LTM8026 when the RUN pin voltage falls to 1.55V. There is also an internal current source that provides 5.5 μ A of pull-down current to program additional UVLO hysteresis. For RUN rising, the current source is sinking 5.5 μ A until RUN = 1.68V, after which it turns off. For RUN falling, the current source is off until the RUN = 1.55V, after which it sinks 5.5 μ A. The following equations determine the voltage

divider resistors for programming the falling UVLO voltage and rising enable voltage (V_{ENA}) as configured in Figure 4.

$$R1 = \frac{1.55 \cdot R2}{UVLO - 1.55}$$

$$R2 = \frac{V_{ENA} - 1.084 \cdot UVLO}{5.5\mu\text{A}}$$

The RUN pin has an absolute maximum voltage of 6V. To accommodate the largest range of applications, there is an internal Zener diode that clamps this pin, so that it can be pulled up to a voltage higher than 6V through a resistor that limits the current to less than 100 μ A. For applications where the supply range is greater than 4:1, size R2 greater than 375k.

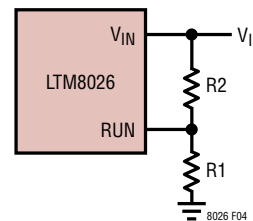

Figure 4. UVLO Configuration

Load Sharing

Two or more LTM8026s may be paralleled to produce higher currents. To do this, simply tie V_{OUT} , SS, RUN and ADJ together. The value of the ADJ resistor is given by the equation:

$$R_{ADJ} = \frac{11.9}{n(V_{OUT} - 1.19)} \text{ k}\Omega$$

where n is the number of LTM8026s in parallel. Given the LTM8026's accurate current limit and CVCC operation, each paralleled unit will contribute a portion of the output current, up to the amount determined by the CTL_I and CTL_T pins. An example of this is given in the Typical Applications section.

Two or more LTM8026s can share load current equally by using a simple op amp circuit to simultaneously modulate the CTL_I pins. Tie SS, RUN, and V_{OUT} and CTL_I of all of the paralleled LTM8026s together. An example of two

APPLICATIONS INFORMATION

LTM8026s equally sharing output current is shown in the Typical Applications section. The modulation of the CTL_I inputs is performed at a high bandwidth, so use an op amp with a gain bandwidth product greater than 1MHz. The example circuit in the Typical Applications section uses the LTC6255, which has a minimum gain bandwidth product of 2MHz.

The LTM8026's CVCC operation provides the ability to power share the load among several input voltage sources. An example of this is shown in the Typical Applications section; please refer to the schematic while reading this discussion. Suppose the application powers 2.5V at 8A and the system under consideration has regulated 24V and 12V input rails available. The power budget for the power rails says that each can allocate only 750mA to produce 2.5V. From the Input Current vs Output Current graph in the Typical Performance Characteristics section for 2.5V_{OUT}, 750mA from the 24V rail can support more than 5A output current, so apply a 66.5k/140k from V_{REF} to the CTL_I pin of the LTM8026 powered from 24V_{IN} to set the output current to 5A. These resistor values were derived as follows:

1. The typical output current limit is 5.6A for CTL_I = 1.5V and above.
2. To get 5A, make the voltage on CTL_I = $1.5V \cdot 5A / 5.6A = 1.34V$.
3. The V_{REF} node is a regulated 2V, so applying the 66.5k/140k network yields $2V \cdot 140k / (66.5k + 140k) = 1.35V$

The LTM8026 powered from 12V_{IN} needs to supply the rest of the load current, or 3A. Again referring to the Input Current vs Output Current graph in the Typical Performance Characteristics section for 2.5V_{OUT}, 750mA will support more than 3A when operated from 12V_{IN}. Using a method similar to the above, apply a resistor network of 132k/78.7k to the CTL_I pin:

1. To get 2.5A, make the voltage on CTL_I = $1.5V \cdot 3A / 5.6A = 0.8V$
2. Applying a 132k/88.7k network to V_{REF} and CTL_I yields $2V \cdot 88.7k / (88.7k + 132k) = 0.8V$

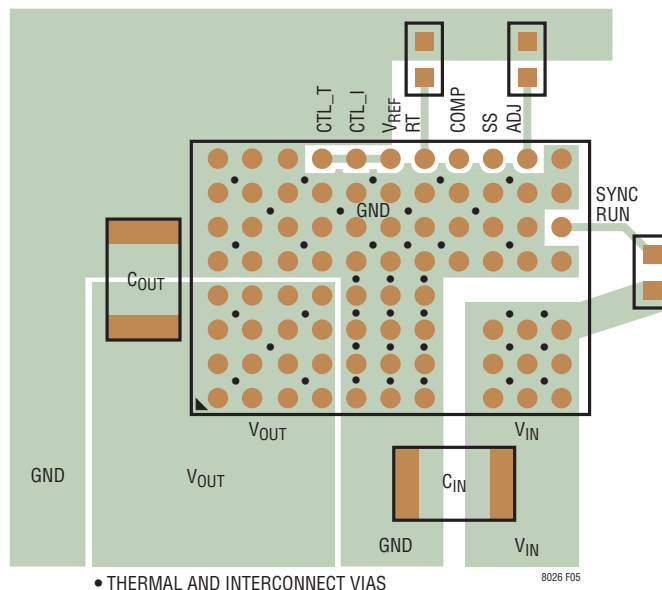

Figure 5. Layout Showing Suggested External Components, GND Plane and Thermal Vias.

As seen in the graph accompanying the schematic in the Typical Applications section, the input currents to each LTM8026 stays below 750mA for all loads below 8A.

PCB Layout

Most of the headaches associated with PCB layout have been alleviated or even eliminated by the high level of integration of the LTM8026. The LTM8026 is nevertheless a switching power supply, and care must be taken to minimize EMI and ensure proper operation. Even with the high level of integration, you may fail to achieve specified operation with a haphazard or poor layout. See Figure 5 for a suggested layout. Ensure that the grounding and heat sinking are acceptable.

A few rules to keep in mind are:

1. Place the R_{ADJ} and R_T resistors as close as possible to their respective pins.
2. Place the C_{IN} capacitor as close as possible to the V_{IN} and GND connection of the LTM8026.

APPLICATIONS INFORMATION

- Place the C_{OUT} capacitor as close as possible to the V_{OUT} and GND connection of the LTM8026.
- Place the C_{IN} and C_{OUT} capacitors such that their ground current flow directly adjacent or underneath the LTM8026.
- Connect all of the GND connections to as large a copper pour or plane area as possible on the top layer. Avoid breaking the ground connection between the external components and the LTM8026.
- Use vias to connect the GND copper area to the board's internal ground planes. Liberally distribute these GND vias to provide both a good ground connection and thermal path to the internal planes of the printed circuit board. Pay attention to the location and density of the thermal vias in Figure 5. The LTM8026 can benefit from the heat sinking afforded by vias that connect to internal GND planes at these locations, due to their proximity to internal power handling components. The optimum number of thermal vias depends upon the printed circuit board design. For example, a board might use very small via holes. It should employ more thermal vias than a board that uses larger holes.

Hot Plugging Safely

The small size, robustness and low impedance of ceramic capacitors make them an attractive option for the input bypass capacitor of LTM8026. However, these capacitors can cause problems if the LTM8026 is plugged into a live input supply (see Application Note 88 for a complete discussion). The low loss ceramic capacitor combined with stray inductance in series with the power source forms an underdamped tank circuit, and the voltage at the V_{IN} pin of the LTM8026 can ring to more than twice the nominal input voltage, possibly exceeding the LTM8026's rating and damaging the part. If the input supply is poorly controlled or the user will be plugging the LTM8026 into an energized supply, the input network should be designed to prevent this overshoot. This can be accomplished by installing a small resistor in series to V_{IN} , but the most popular method of controlling input voltage overshoot is to add an electrolytic bulk capacitor to the V_{IN} net. This capacitor's relatively high equivalent series resistance

damps the circuit and eliminates the voltage overshoot. The extra capacitor improves low frequency ripple filtering and can slightly improve the efficiency of the circuit, though it is physically large.

Thermal Considerations

The LTM8026 output current may need to be derated if it is required to operate in a high ambient temperature. The amount of current derating is dependent upon the input voltage, output power and ambient temperature. The temperature rise curves given in the Typical Performance Characteristics section can be used as a guide. These curves were generated by the LTM8026 mounted to a 58cm² 4-layer FR4 printed circuit board. Boards of other sizes and layer count can exhibit different thermal behavior, so it is incumbent upon the user to verify proper operation over the intended system's line, load and environmental operating conditions.

For increased accuracy and fidelity to the actual application, many designers use finite element analysis (FEA) to predict thermal performance. To that end, Page 2 of the data sheet typically gives four thermal coefficients:

θ_{JA} – Thermal resistance from junction to ambient

$\theta_{JCbottom}$ – Thermal resistance from junction to the bottom of the product case

θ_{JCtop} – Thermal resistance from junction to top of the product case

θ_{JB} – Thermal resistance from junction to the printed circuit board.

While the meaning of each of these coefficients may seem to be intuitive, JEDEC has defined each to avoid confusion and inconsistency. These definitions are given in JESD 51-12, and are quoted or paraphrased below:

θ_{JA} is the natural convection junction-to-ambient air thermal resistance measured in a one cubic foot sealed enclosure. This environment is sometimes referred to as "still air" although natural convection causes the air to move. This value is determined with the part mounted to a JESD 51-9 defined test board, which does not reflect an actual application or viable operating condition.

APPLICATIONS INFORMATION

$\theta_{JCbottom}$ is the junction-to-board thermal resistance with all of the component power dissipation flowing through the bottom of the package. In the typical μ Module regulator, the bulk of the heat flows out the bottom of the package, but there is always heat flow out into the ambient environment. As a result, this thermal resistance value may be useful for comparing packages but the test conditions don't generally match the user's application.

θ_{JCtop} is determined with nearly all of the component power dissipation flowing through the top of the package. As the electrical connections of the typical μ Module regulator are on the bottom of the package, it is rare for an application to operate such that most of the heat flows from the junction to the top of the part. As in the case of $\theta_{JCbottom}$, this value may be useful for comparing packages but the test conditions don't generally match the user's application.

θ_{JB} is the junction-to-board thermal resistance where almost all of the heat flows through the bottom of the μ Module regulator and into the board, and is really the sum of the $\theta_{JCbottom}$ and the thermal resistance of the bottom of the part through the solder joints and through a portion of the board. The board temperature is measured a specified distance from the package, using a 2-sided, 2-layer board. This board is described in JESD 51-9.

Given these definitions, it should now be apparent that none of these thermal coefficients reflects an actual physical operating condition of a μ Module regulator. Thus, none of them can be individually used to accurately predict the thermal performance of the product. Likewise, it would be inappropriate to attempt to use any one coefficient to correlate to the junction temperature vs load graphs given in the product's data sheet. The only appropriate way to use the coefficients is when running a detailed thermal analysis, such as FEA, which considers all of the thermal resistances simultaneously.

A graphical representation of these thermal resistances is given in Figure 6.

The blue resistances are contained within the μ Module device, and the green are outside.

The die temperature of the LTM8026 must be lower than the maximum rating of 125°C, so care should be taken in the layout of the circuit to ensure good heat sinking of the LTM8026. The bulk of the heat flow out of the LTM8026 is through the bottom of the module and the pads into the printed circuit board. Consequently a poor printed circuit board design can cause excessive heating, resulting in impaired performance or reliability. Please refer to the PCB Layout section for printed circuit board design suggestions.

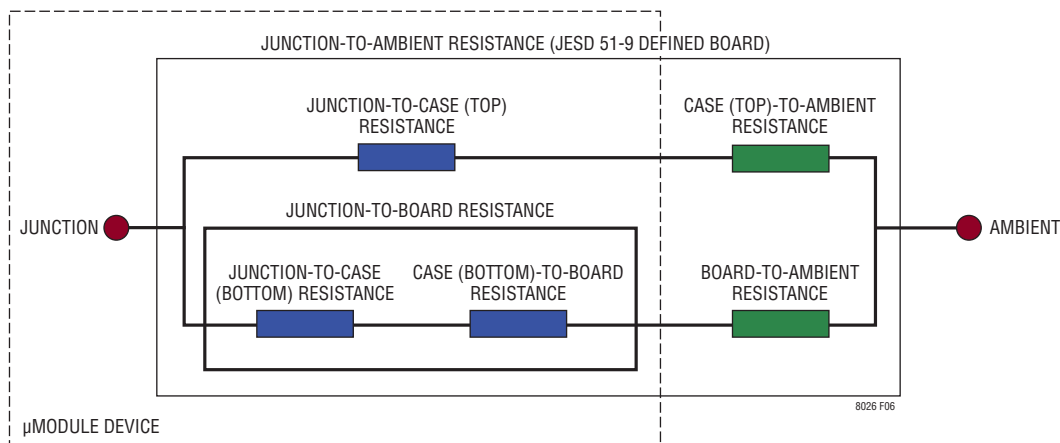
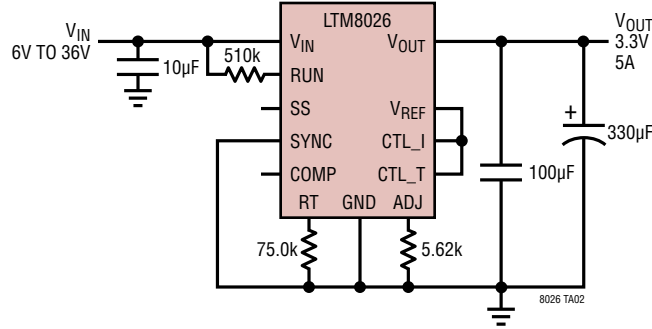

Figure 6

TYPICAL APPLICATIONS

36V_{IN}, 3.3V_{OUT} Step-Down CVCC Converter



36V_{IN}, 5.6A Two 2.5V Series Supercapacitor Charger

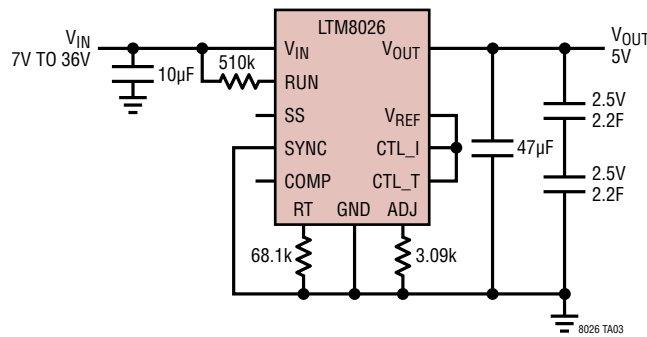

36V_{IN}, 12V_{OUT} Step-Down CVCC Converter

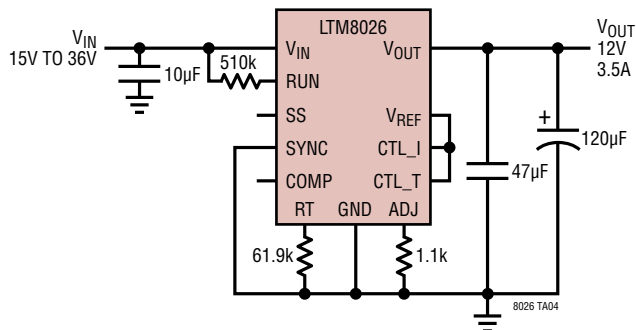

TYPICAL APPLICATIONS

31V_{IN}, -5V_{OUT} Negative CVCC Converter

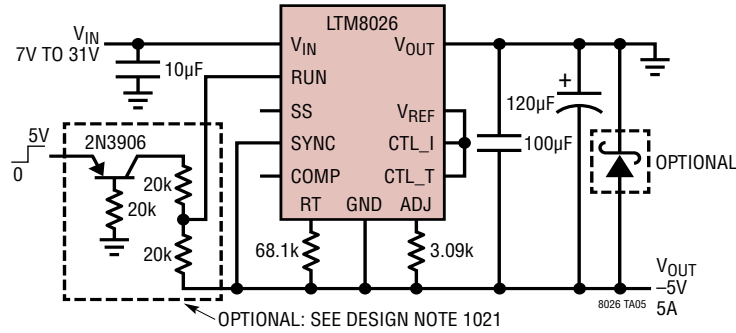

Two LTM8026s Operating in Parallel to Produce 2.5V_{OUT} at 10A

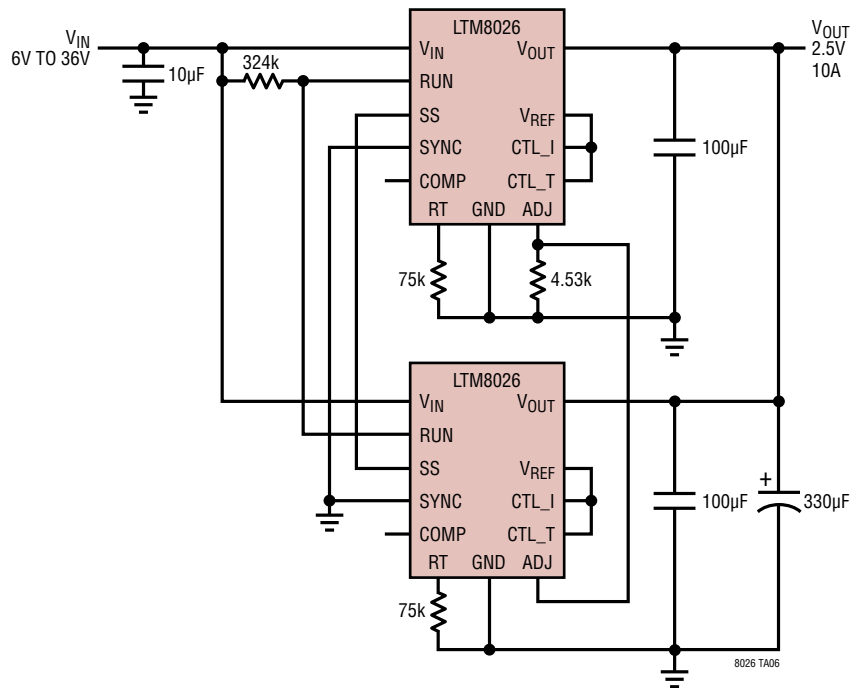

TYPICAL APPLICATIONS

Two LTM8026s Operating in Parallel to Produce 2.5V_{OUT} at 10A, Equally Sharing Current

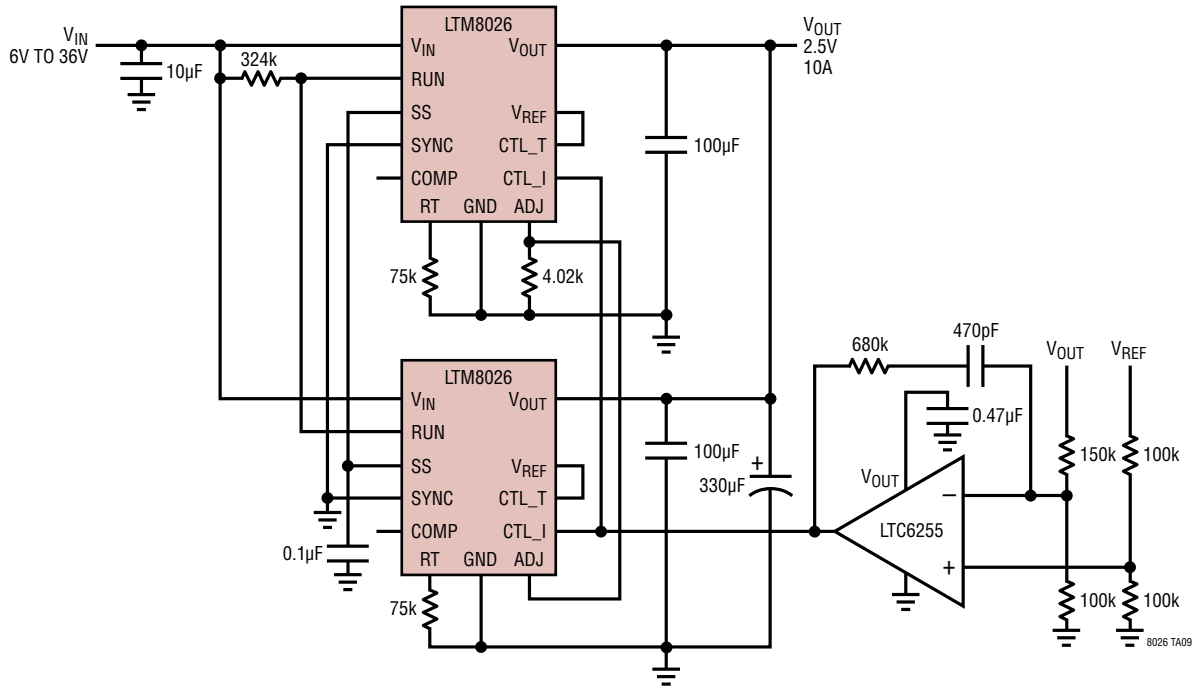

TYPICAL APPLICATIONS

Two LTM8026s Running from 12V and 24V. At Max Load, Each LTM8026 Draws Less Than 750mA from Their Respective Input Sources

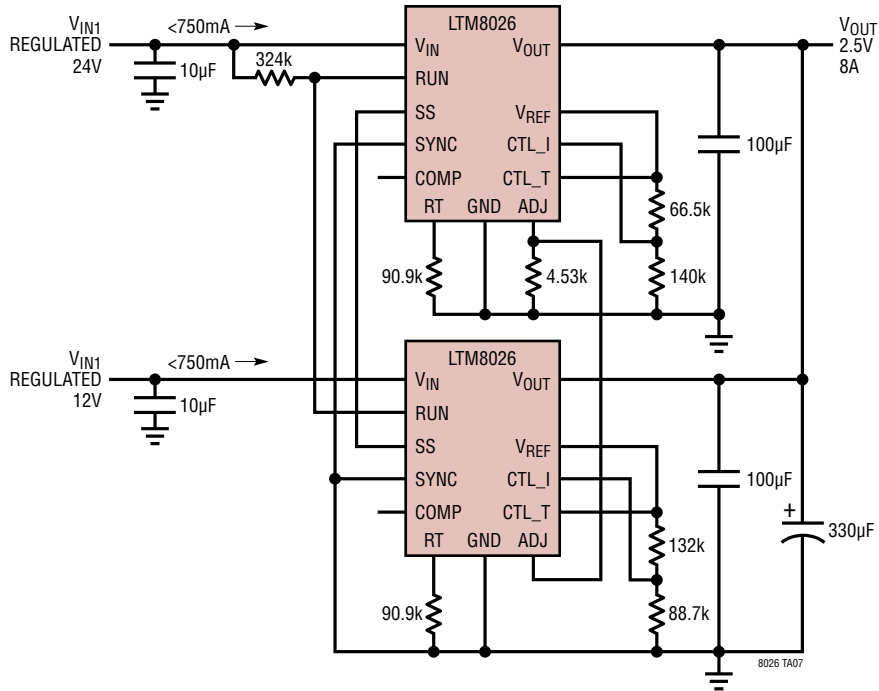

Input Current vs Output Current

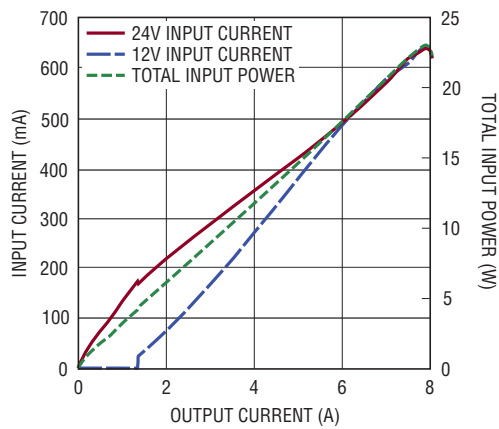

PACKAGE DESCRIPTION

**Table 3. Pin Assignment Table
(Arranged by Pin Number)**

PIN	NAME	PIN	NAME	PIN	NAME	PIN	NAME	PIN	NAME	PIN	NAME
A1	V _{OUT}	B1	V _{OUT}	C1	V _{OUT}	D1	V _{OUT}	E1	GND	F1	GND
A2	V _{OUT}	B2	V _{OUT}	C2	V _{OUT}	D2	V _{OUT}	E2	GND	F2	GND
A3	V _{OUT}	B3	V _{OUT}	C3	V _{OUT}	D3	V _{OUT}	E3	GND	F3	GND
A4	V _{OUT}	B4	V _{OUT}	C4	V _{OUT}	D4	V _{OUT}	E4	GND	F4	GND
A5	GND	B5	GND	C5	GND	D5	GND	E5	GND	F5	GND
A6	GND	B6	GND	C6	GND	D6	GND	E6	GND	F6	GND
A7	GND	B7	GND	C7	GND	D7	GND	E7	GND	F7	GND
A8	GND	B8	GND	C8	GND	D8	CTL_T	E8	CTL_I	F8	V _{REF}

PIN	NAME	PIN	NAME	PIN	NAME	PIN	NAME	PIN	NAME
G1	GND			J1	V _{IN}	K1	V _{IN}	L1	V _{IN}
G2	GND			J2	V _{IN}	K2	V _{IN}	L2	V _{IN}
G3	GND			J3	V _{IN}	K3	V _{IN}	L3	V _{IN}
G4	GND								
G5	GND	H5	GND	J5	GND	K5	GND	L5	GND
G6	GND	H6	GND	J6	GND	K6	GND	L6	RUN
G7	GND	H7	GND	J7	GND	K7	GND	L7	SYNC
G8	RT	H8	COMP	J8	SS	K8	ADJ	L8	GND

PACKAGE PHOTO

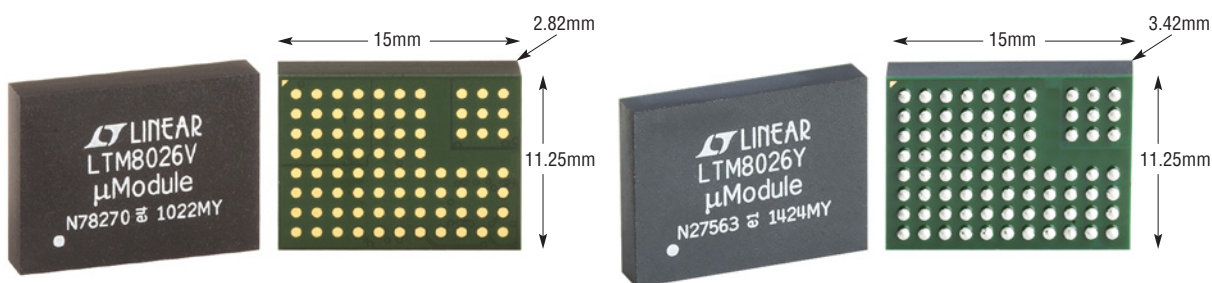

PACKAGE DESCRIPTION

Please refer to <http://www.linear.com/product/LTM8026#packaging> for the most recent package drawings.

LGA Package
81-Lead (15mm × 11.25mm × 2.82mm)
 (Reference LTC DWG # 05-08-1868 Rev A)

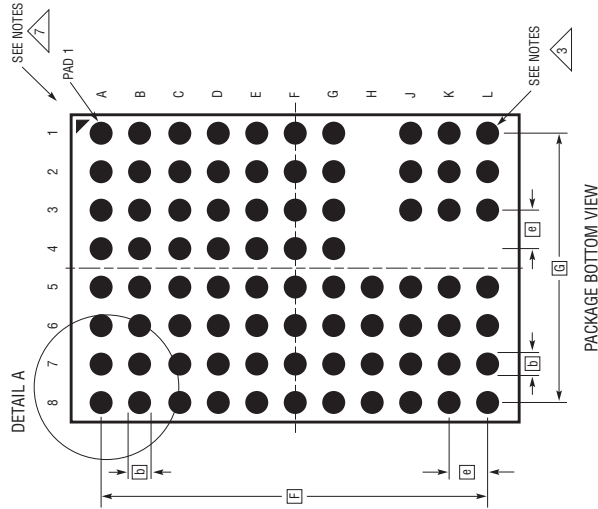

- NOTES:
1. DIMENSIONING AND TOLERANCING PER ASME Y14.5M-1994
 2. ALL DIMENSIONS ARE IN MILLIMETERS
 3. LAND DESIGNATION PER JEDEC MO-222, SPP-010
 4. DETAILS OF PAD #1 IDENTIFIER ARE OPTIONAL, BUT MUST BE LOCATED WITHIN THE ZONE INDICATED. THE PAD #1 IDENTIFIER MAY BE EITHER A MOLD OR MARKED FEATURE
 5. PRIMARY DATUM -Z- IS SEATING PLANE
 6. THE TOTAL NUMBER OF PADS: 81

⚠ PACKAGE ROW AND COLUMN LABELING MAY VARY AMONG μ Module PRODUCTS. REVIEW EACH PACKAGE LAYOUT CAREFULLY

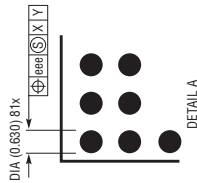
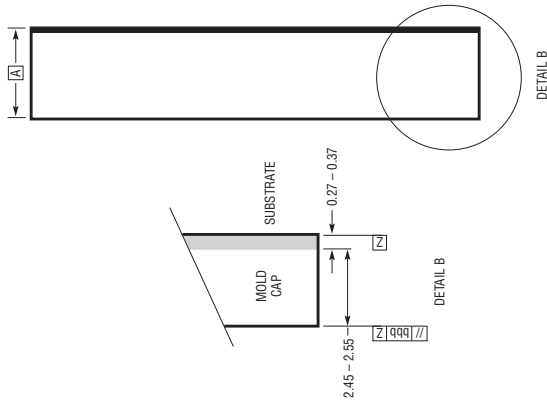
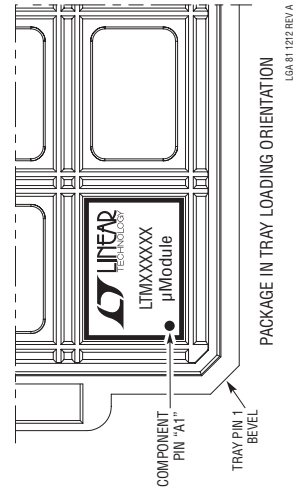

DIMENSIONS			
SYMBOL	MIN	MAX	NOTES
A	2.72	2.82	2.92
b	0.60	0.63	0.66
D	15.0		
E	11.25		
e	1.27		
F	12.70		
G	8.89		
aaa	0.15		
bbb	0.10		
eee	0.05		
TOTAL NUMBER OF LGA PADS: 81			

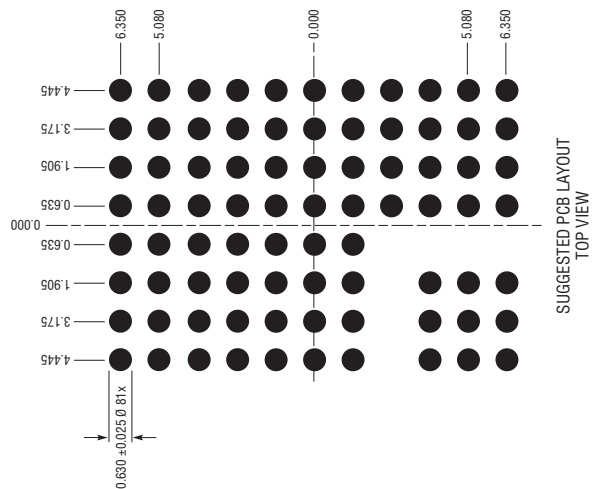
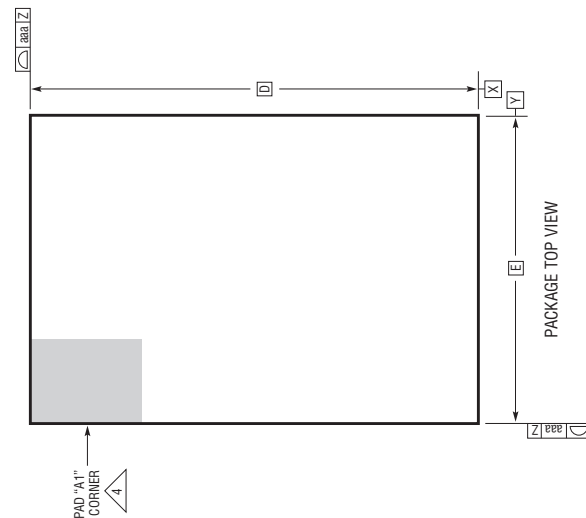

PACKAGE DESCRIPTION

Please refer to <http://www.linear.com/product/LTM8026#packaging> for the most recent package drawings.

BGA Package
81-Lead (15mm × 11.25mm × 3.42mm)
 (Reference LTC DWG # 05-08-1959 Rev A)

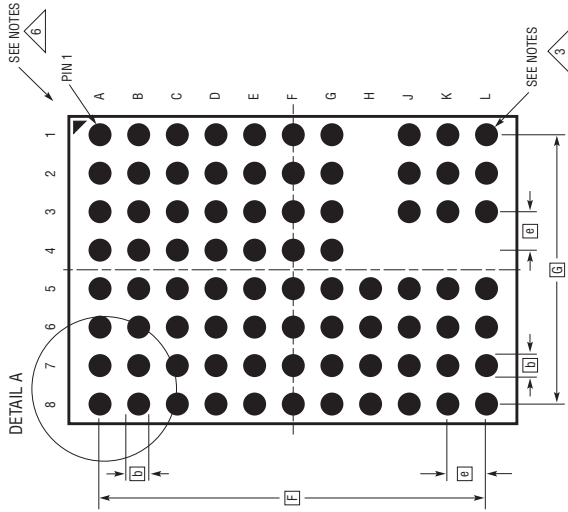

- NOTES:**
- DIMENSIONING AND TOLERANCING PER ASME Y14.5M-1994
 - ALL DIMENSIONS ARE IN MILLIMETERS
 - BALL DESIGNATION PER JEDEC MS-028 AND JEP95
 - DETAILS OF PIN #1 IDENTIFIER ARE OPTIONAL, BUT MUST BE LOCATED WITHIN THE ZONE INDICATED. THE PIN #1 IDENTIFIER MAY BE EITHER A MOLD OR MARKED FEATURE
 - PRIMARY DATUM - Z - IS SEATING PLANE
 - PACKAGE ROW AND COLUMN LABELING MAY VARY AMONG μ Module PRODUCTS. REVIEW EACH PACKAGE LAYOUT CAREFULLY

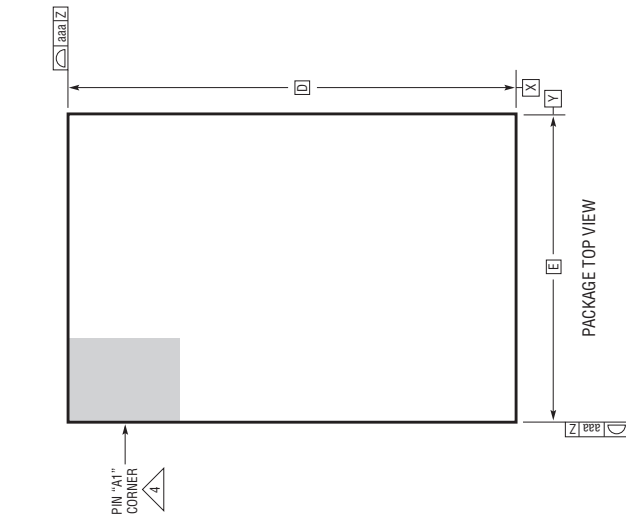
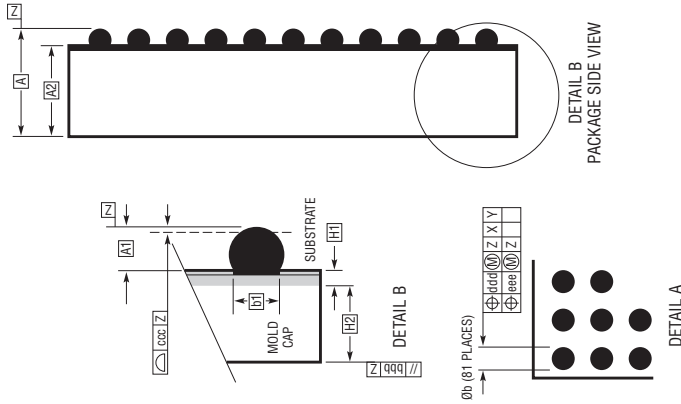
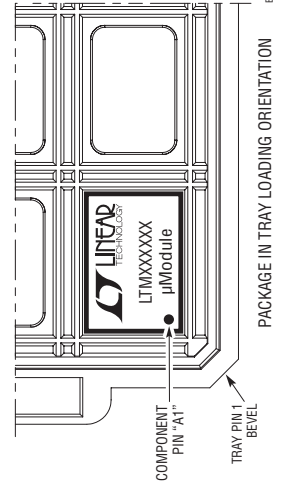

DIMENSIONS				
SYMBOL	MIN	NOM	MAX	NOTES
A	3.22	3.42	3.62	
A1	0.50	0.60	0.70	BALL HT
A2	2.72	2.82	2.92	
b	0.60	0.75	0.90	BALL DIMENSION
b1	0.60	0.63	0.66	PAD DIMENSION
D	15.00			
E	11.25			
e	1.27			
F	12.70			
G	8.89			
H1	0.27	0.32	0.37	SUBSTRATE THK
H2	2.45	2.50	2.55	MOLD CAP HT
aaa	0.15			
bbb	0.10			
ccc	0.20			
ddd	0.30			
eee	0.15			
				TOTAL NUMBER OF BALLS: 81

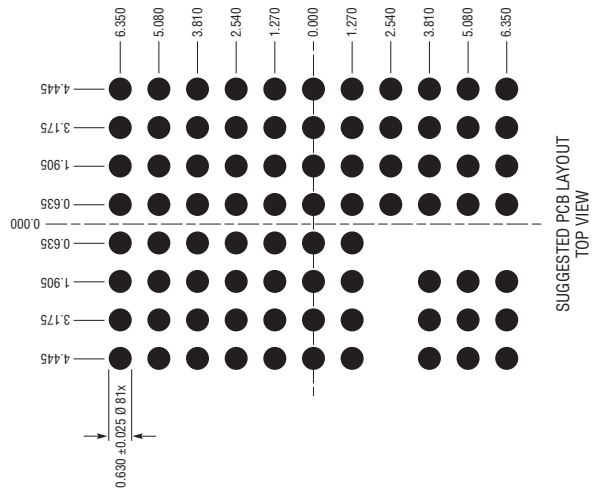

REVISION HISTORY

REV	DATE	DESCRIPTION	PAGE NUMBER
A	8/12	Added MP-Grade	2-3
B	5/13	Update maximum solder temperature	2
		Update Package Description drawing	24
C	07/15	Added BGA Package	1, 2, 26
D	06/17	Corrected Device Part Marking of LTM8026MPV#PBF	2

TYPICAL APPLICATION

36V_{IN}, 3.3V_{OUT} Step-Down Converter with 4.75A Accurate Current Limit

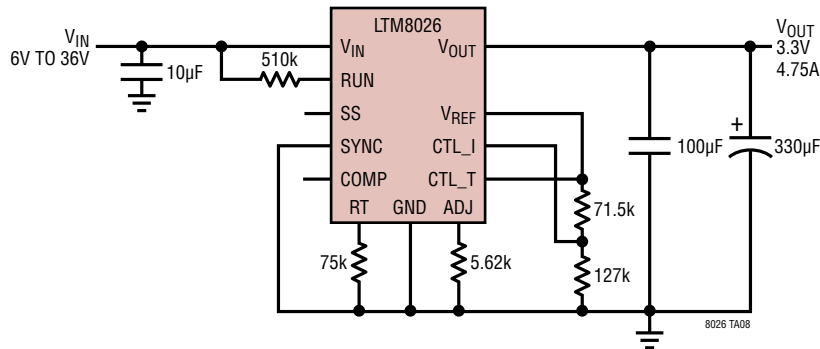

DESIGN RESOURCES

SUBJECT	DESCRIPTION
µModule Design and Manufacturing Resources	<p>Design:</p> <ul style="list-style-type: none"> • Selector Guides • Demo Boards and Gerber Files • Free Simulation Tools <p>Manufacturing:</p> <ul style="list-style-type: none"> • Quick Start Guide • PCB Design, Assembly and Manufacturing Guidelines • Package and Board Level Reliability
µModule Regulator Products Search	<ol style="list-style-type: none"> 1. Sort table of products by parameters and download the result as a spread sheet. 2. Search using the Quick Power Search parametric table. <div style="border: 1px solid #ccc; padding: 5px; margin: 10px 0;"> <p>Quick Power Search</p> <p>Input V_{in} (Min) <input type="text"/> V V_{in} (Max) <input type="text"/> V</p> <p>Output V_{out} <input type="text"/> V I_{out} <input type="text"/> A</p> <p style="text-align: center;"><input type="button" value="Search"/></p> </div>
TechClip Videos	Quick videos detailing how to bench test electrical and thermal performance of µModule products.
Digital Power System Management	Linear Technology's family of digital power supply management ICs are highly integrated solutions that offer essential functions, including power supply monitoring, supervision, margining and sequencing, and feature EEPROM for storing user configurations and fault logging.

RELATED PARTS

PART NUMBER	DESCRIPTION	COMMENTS
LTM8062	32V _{IN} , 2A µModule Battery Charger with Maximum Peak Power Tracking (MPPT)	Adjustable V _{BATT} up to 14.4V, C/10 or Timer Termination, 9mm × 15mm × 4.32mm LGA Package
LTM8027	60V _{IN} , 4A DC/DC Step-Down µModule Regulator	4.5V ≤ V _{IN} ≤ 60V, 2.5V ≤ V _{OUT} ≤ 24V, 15mm × 15mm × 4.32mm LGA Package
LTM8052	36V _{IN} , ±5A µModule Regulator with Adjustable Accurate Current Limit	6V ≤ V _{IN} ≤ 36V, 1.2V ≤ V _{OUT} ≤ 24V, -5V ≤ I _{OUT} ≤ 5A, Synchronizable, Pin Compatible with LTM8026, 11.25mm × 15mm × 2.82mm LGA Package
LTM4618	26V _{IN} , 6A Step-Down µModule Regulator	4.5V ≤ V _{IN} ≤ 26.5V, 0.8V ≤ V _{OUT} ≤ 5V, Synchronizable, V _{OUT} Tracking, 9mm × 15mm × 4.3mm LGA Package
LTM4612	5A EN55022 Class B DC/DC Step-Down µModule Regulator	5V ≤ V _{IN} ≤ 36V, 3.3V ≤ V _{OUT} ≤ 15V, PLL Input, V _{OUT} Tracking and Margining, 15mm × 15mm × 2.8mm LGA Package
LTC2978	Octal Digital Power Supply Manager with EEPROM	I ² C/PMBus Interface, Configuration EEPROM, Fault Logging, 16-Bit ADC with ±0.25% TUE, 3.3V to 15V Operation
LTC2974	Quad Digital Power Supply Manager with EEPROM	I ² C/PMBus Interface, Configuration EEPROM, Fault Logging, Per Channel Voltage, Current and Temperature Measurements

8026fd

Looking for pricing, stock, or lifecycle information?

Click below to explore more details on WIN SOURCE:

 [View LTM8026IY on WIN SOURCE](#)

 [Analog Devices Inc. Information](#)

Optimize Your Supply Chain with WIN SOURCE Solutions

-  Global Sourcing Solution
-  Obsolete Management
-  Cost Control Management
-  Shortage Management
-  Alternative Solution
-  Excess Inventory Management