



THE DATASHEET OF
SG2803L-883B



SN5410, SN54LS10, SN54S10, SN7410, SN74LS10, SN74S10 TRIPLE 3-INPUT POSITIVE-NAND GATES

SDLS035A - DECEMBER 1983 - REVISED APRIL 2003

- Package Options Include Plastic "Small Outline" Packages, Ceramic Chip Carriers and Flat Packages, and Plastic and Ceramic DIPs
- Dependable Texas Instruments Quality and Reliability

description

These devices contain three independent 3-input NAND gates.

The SN5410, SN54LS10, and SN54S10 are characterized for operation over the full military temperature range of -55°C to 125°C . The SN7410, SN74LS10, and SN74S10 are characterized for operation from 0°C to 70°C .

FUNCTION TABLE (each gate)

INPUTS			OUTPUT
A	B	C	Y
H	H	H	L
L	X	X	H
X	L	X	H
X	X	L	H

logic symbol†

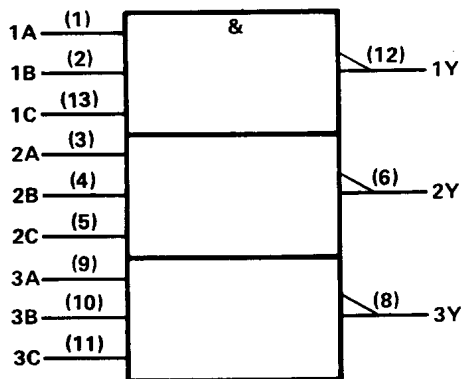

†This symbol is in accordance with ANSI/IEEE Std. 91-1984 and IEC Publication 617-12.

Pin numbers shown are for D, J, and N packages.

positive logic

$$Y = \overline{A \cdot B \cdot C} \text{ or } Y = \overline{A} + \overline{B} + \overline{C}$$

SN5410 . . . J PACKAGE
SN54LS10, SN54S10 . . . J OR W PACKAGE
SN7410 . . . N PACKAGE
SN74LS10, SN74S10 . . . D OR N PACKAGE

(TOP VIEW)

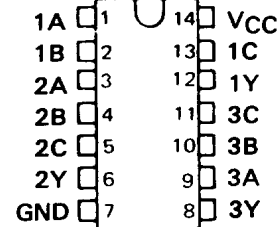

SN5410 . . . W PACKAGE

(TOP VIEW)

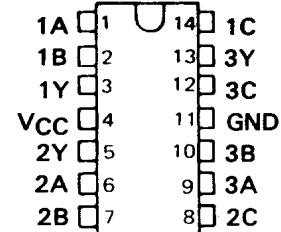

SN54LS10, SN54S10 . . . FK PACKAGE

(TOP VIEW)

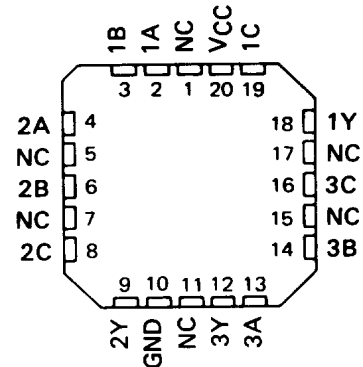

NC - No internal connection

logic diagram (positive logic)

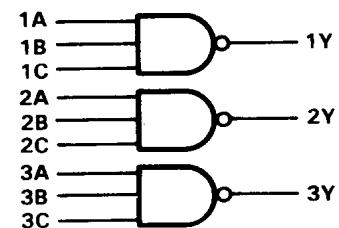

**SN5410, SN54LS10, SN54S10,
SN7410, SN74LS10, SN74S10
TRIPLE 3-INPUT POSITIVE-NAND GATES**

SDLS035A – DECEMBER 1983 – REVISED APRIL 2003

schematics (each gate)

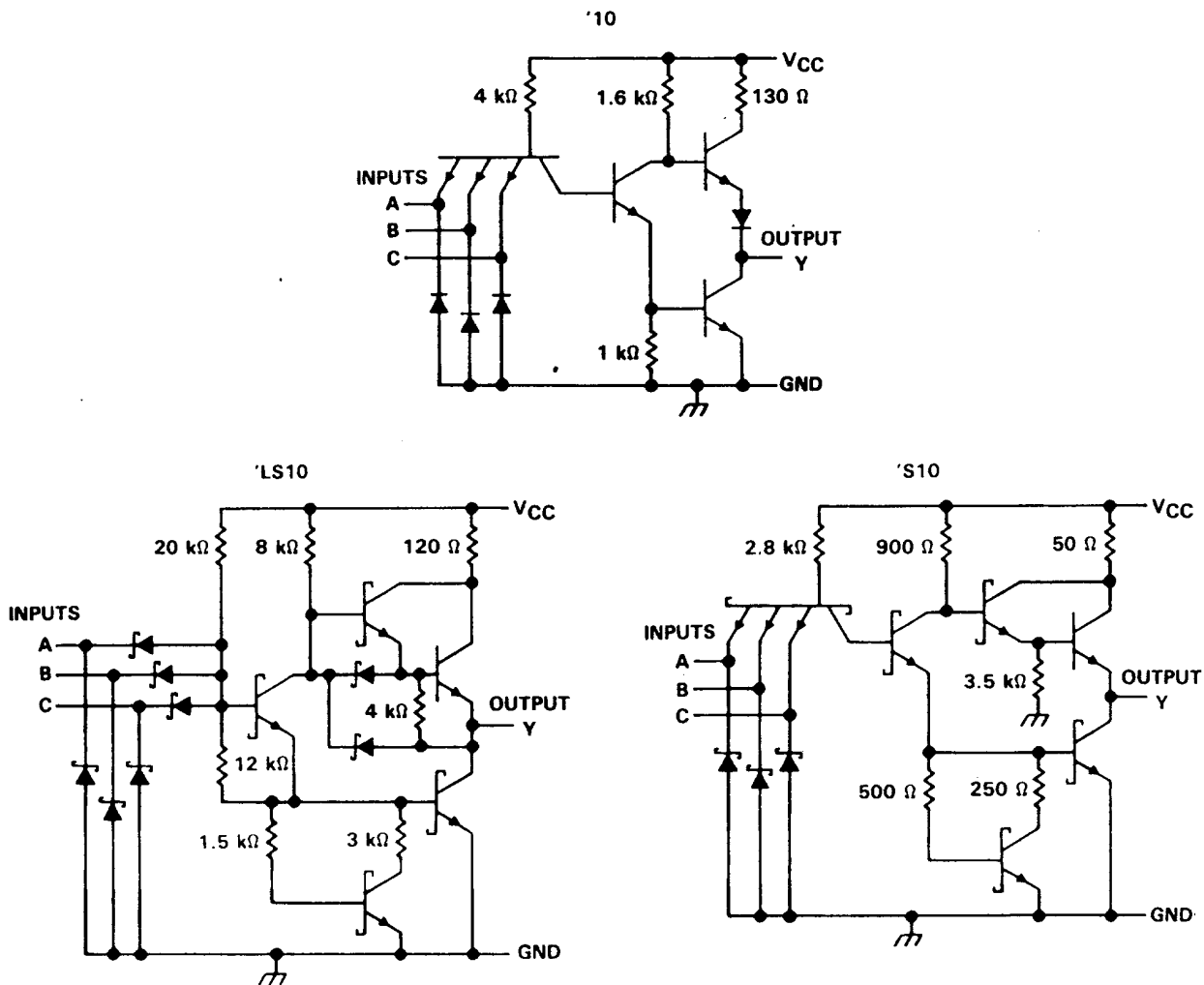

Resistor values shown are nominal.

absolute maximum ratings over operating free-air temperature range (unless otherwise noted)

Supply voltage, V_{CC} (see Note 1)	7 V
Input voltage: '10, 'S10	5.5 V
'LS10	7 V
Operating free-air temperature range: SN54'	-55°C to 125°C
SN74'	0°C to 70°C
Storage temperature range	-65°C to 150°C

NOTE 1: Voltage values are with respect to network ground terminal.



POST OFFICE BOX 655303 • DALLAS, TEXAS 75265

SN5410, SN7410, TRIPLE 3-INPUT POSITIVE-NAND GATES

SDLS035 – DECEMBER 1983 – REVISED MARCH 1988

recommended operating conditions

	SN5410			SN7410			UNIT
	MIN	NOM	MAX	MIN	NOM	MAX	
V _{CC} Supply voltage	4.5	5	5.5	4.75	5	5.25	V
V _{IH} High-level input voltage	2			2			V
V _{IL} Low-level input voltage			0.8			0.8	V
I _{OH} High-level output current			-0.4			-0.4	mA
I _{OL} Low-level output current			16			16	mA
T _A Operating free-air temperature	-55		125	0		70	°C

electrical characteristics over recommended operating free-air temperature range (unless otherwise noted)

PARAMETER	TEST CONDITIONS †	SN5410			SN7410			UNIT
		MIN	TYP ‡	MAX	MIN	TYP ‡	MAX	
V _{IK}	V _{CC} = MIN, I _I = -12 mA			-1.5			-1.5	V
V _{OH}	V _{CC} = MIN, V _{IL} = 0.8 V, I _{OH} = -0.4 mA	2.4	3.4		2.4	3.4		V
V _{OL}	V _{CC} = MIN, V _{IH} = 2 V, I _{OL} = 16 mA		0.2	0.4		0.2	0.4	V
I _I	V _{CC} = MAX, V _I = 5.5 V			1			1	mA
I _{IH}	V _{CC} = MAX, V _I = 2.4 V			40			40	μA
I _{IL}	V _{CC} = MAX, V _I = 0.4 V			-1.6			-1.6	mA
I _{OS} §	V _{CC} = MAX	-20		-55	-18		-55	mA
I _{CCH}	V _{CC} = MAX, V _I = 0 V		3	6		3	6	mA
I _{CCL}	V _{CC} = MAX, V _I = 4.5 V		9	16.5		9	16.5	mA

† For conditions shown as MIN or MAX, use the appropriate value specified under recommended operating conditions.

‡ All typical values are at V_{CC} = 5 V, T_A = 25°C.

§ Not more than one output should be shorted at a time.

switching characteristics, V_{CC} = 5 V, T_A = 25°C (see note 2)

PARAMETER	FROM (INPUT)	TO (OUTPUT)	TEST CONDITIONS	MIN	TYP	MAX	UNIT
t _{PLH}	A, B or C	Y	R _L = 400 Ω, C _L = 15 pF		11	22	ns
t _{PHL}					7	15	ns

NOTE 2: Load circuits and voltage waveforms are shown in Section 1.

SN54LS10, SN74LS10, TRIPLE 3-INPUT POSITIVE-NAND GATES

SDLS035 – DECEMBER 1983 – REVISED MARCH 1988

recommended operating conditions

	SN54LS10			SN74LS10			UNIT
	MIN	NOM	MAX	MIN	NOM	MAX	
V _{CC} Supply voltage	4.5	5	5.5	4.75	5	5.25	V
V _{IH} High-level input voltage	2			2			V
V _{IL} Low-level input voltage			0.7			0.8	V
I _{OH} High-level output current			-0.4			-0.4	mA
I _{OL} Low-level output current			4			8	mA
T _A Operating free-air temperature	-55		125	0		70	°C

electrical characteristics over recommended operating free-air temperature range (unless otherwise noted)

PARAMETER	TEST CONDITIONS †	SN54LS10			SN74LS10			UNIT
		MIN	TYP‡	MAX	MIN	TYP‡	MAX	
V _{IK}	V _{CC} = MIN, I _I = -18 mA			-1.5			-1.5	V
V _{OH}	V _{CC} = MIN, V _{IL} = MAX, I _{OH} = -0.4 mA	2.5	3.4		2.7	3.4		V
V _{OL}	V _{CC} = MIN, V _{IH} = 2 V, I _{OL} = 4 mA		0.25	0.4			0.4	V
	V _{CC} = MIN, V _{IH} = 2 V, I _{OL} = 8 mA					0.25	0.5	
I _I	V _{CC} = MAX, V _I = 7 V			0.1			0.1	mA
I _{IH}	V _{CC} = MAX, V _I = 2.7 V			20			20	μA
I _{IL}	V _{CC} = MAX, V _I = 0.4 V			-0.4			-0.4	mA
I _{OS} §	V _{CC} = MAX	-20		-100	-20		-100	mA
I _{CCH}	V _{CC} = MAX, V _I = 0 V		0.6	1.2		0.6	1.2	mA
I _{CCL}	V _{CC} = MAX, V _I = 4.5 V		1.8	3.3		1.8	3.3	mA

† For conditions shown as MIN or MAX, use the appropriate value specified under recommended operating conditions.

‡ All typical values are at V_{CC} = 5 V, T_A = 25°C.

§ Not more than one output should be shorted at a time, and the duration of the short-circuit should not exceed one second.

switching characteristics, V_{CC} = 5 V, T_A = 25°C (see note 2)

PARAMETER	FROM (INPUT)	TO (OUTPUT)	TEST CONDITIONS		MIN	TYP	MAX	UNIT
t _{PLH}	A, B or C	Y	R _L = 2 kΩ,	C _L = 15 pF		9	15	ns
t _{PHL}						10	15	ns

NOTE 2: Load circuits and voltage waveforms are shown in Section 1.



SN54S10, SN74S10, TRIPLE 3-INPUT POSITIVE-NAND GATES

SDLS035 – DECEMBER 1983 – REVISED MARCH 1988

recommended operating conditions

	SN54S10			SN74S10			UNIT
	MIN	NOM	MAX	MIN	NOM	MAX	
V _{CC} Supply voltage	4.5	5	5.5	4.75	5	5.25	V
V _{IH} High-level input voltage	2			2			V
V _{IL} Low-level input voltage			0.8			0.8	V
I _{OH} High-level output current			-1			-1	mA
I _{OL} Low-level output current			20			20	mA
T _A Operating free-air temperature	-55		125	0		70	°C

electrical characteristics over recommended operating free-air temperature range (unless otherwise noted)

PARAMETER	TEST CONDITIONS †	SN54S10			SN74S10			UNIT
		MIN	TYP ‡	MAX	MIN	TYP ‡	MAX	
V _{IK}	V _{CC} = MIN, I _I = -18 mA			-1.2			-1.2	V
V _{OH}	V _{CC} = MIN, V _{IL} = 0.8 V, I _{OH} = -1 mA	2.5	3.4		2.7	3.4		V
V _{OL}	V _{CC} = MIN, V _{IH} = 2 V, I _{OL} = 20 mA			0.5			0.5	V
I _I	V _{CC} = MAX, V _I = 5.5 V			1			1	mA
I _{IH}	V _{CC} = MAX, V _I = 2.7 V			50			50	μA
I _{IL}	V _{CC} = MAX, V _I = 0.5 V			-2			-2	mA
I _{OS} §	V _{CC} = MAX	-40		-100	-40		-100	mA
I _{CC} H	V _{CC} = MAX, V _I = 0 V		7.5	12		7.5	12	mA
I _{CC} L	V _{CC} = MAX, V _I = 4.5 V		15	27		15	27	mA

† For conditions shown as MIN or MAX, use the appropriate value specified under recommended operating conditions.

‡ All typical values are at V_{CC} = 5 V, T_A = 25°C.

§ Not more than one output should be shorted at a time, and the duration of the short-circuit should not exceed one second.

switching characteristics, V_{CC} = 5 V, T_A = 25°C (see note 2)

PARAMETER	FROM (INPUT)	TO (OUTPUT)	TEST CONDITIONS	MIN	TYP	MAX	UNIT
t _{PLH}	A, B or C	Y	R _L = 280 Ω, C _L = 15 pF		3	4.5	ns
t _{PHL}					3	5	ns
t _{PLH}			R _L = 280 Ω, C _L = 50 pF		4.5		ns
t _{PHL}					5		ns

NOTE 2: Load circuits and voltage waveforms are shown in Section 1.



PACKAGING INFORMATION

Orderable Device	Status (1)	Package Type	Package Drawing	Pins	Package Qty	Eco Plan (2)	Lead finish/ Ball material (6)	MSL Peak Temp (3)	Op Temp (°C)	Device Marking (4/5)	Samples
JM38510/07005BCA	ACTIVE	CDIP	J	14	25	Non-RoHS & Green	SNPB	N / A for Pkg Type	-55 to 125	JM38510/ 07005BCA	Samples
JM38510/07005BDA	ACTIVE	CFP	W	14	25	Non-RoHS & Green	SNPB	N / A for Pkg Type	-55 to 125	JM38510/ 07005BDA	Samples
JM38510/30005B2A	ACTIVE	LCCC	FK	20	55	Non-RoHS & Green	SNPB	N / A for Pkg Type	-55 to 125	JM38510/ 30005B2A	Samples
JM38510/30005BCA	ACTIVE	CDIP	J	14	25	Non-RoHS & Green	SNPB	N / A for Pkg Type	-55 to 125	JM38510/ 30005BCA	Samples
JM38510/30005BDA	ACTIVE	CFP	W	14	25	Non-RoHS & Green	SNPB	N / A for Pkg Type	-55 to 125	JM38510/ 30005BDA	Samples
JM38510/30005SDA	ACTIVE	CFP	W	14	25	Non-RoHS & Green	SNPB	N / A for Pkg Type	-55 to 125	JM38510/ 30005SDA	Samples
M38510/07005BCA	ACTIVE	CDIP	J	14	25	Non-RoHS & Green	SNPB	N / A for Pkg Type	-55 to 125	JM38510/ 07005BCA	Samples
M38510/07005BDA	ACTIVE	CFP	W	14	25	Non-RoHS & Green	SNPB	N / A for Pkg Type	-55 to 125	JM38510/ 07005BDA	Samples
M38510/30005B2A	ACTIVE	LCCC	FK	20	55	Non-RoHS & Green	SNPB	N / A for Pkg Type	-55 to 125	JM38510/ 30005B2A	Samples
M38510/30005BCA	ACTIVE	CDIP	J	14	25	Non-RoHS & Green	SNPB	N / A for Pkg Type	-55 to 125	JM38510/ 30005BCA	Samples
M38510/30005BDA	ACTIVE	CFP	W	14	25	Non-RoHS & Green	SNPB	N / A for Pkg Type	-55 to 125	JM38510/ 30005BDA	Samples
M38510/30005SDA	ACTIVE	CFP	W	14	25	Non-RoHS & Green	SNPB	N / A for Pkg Type	-55 to 125	JM38510/ 30005SDA	Samples
SN54LS10J	ACTIVE	CDIP	J	14	25	Non-RoHS & Green	SNPB	N / A for Pkg Type	-55 to 125	SN54LS10J	Samples
SN54S10J	ACTIVE	CDIP	J	14	25	Non-RoHS & Green	SNPB	N / A for Pkg Type	-55 to 125	SN54S10J	Samples
SN74LS10DR	ACTIVE	SOIC	D	14	2500	RoHS & Green	NIPDAU	Level-1-260C-UNLIM	0 to 70	LS10	Samples
SN74LS10DRG4	ACTIVE	SOIC	D	14	2500	RoHS & Green	NIPDAU	Level-1-260C-UNLIM	0 to 70	LS10	Samples
SN74LS10N	ACTIVE	PDIP	N	14	25	RoHS & Green	NIPDAU	N / A for Pkg Type	0 to 70	SN74LS10N	Samples

Orderable Device	Status (1)	Package Type	Package Drawing	Pins	Package Qty	Eco Plan (2)	Lead finish/ Ball material (6)	MSL Peak Temp (3)	Op Temp (°C)	Device Marking (4/5)	Samples
SN74LS10NSR	ACTIVE	SO	NS	14	2000	RoHS & Green	NIPDAU	Level-1-260C-UNLIM	0 to 70	74LS10	Samples
SN74S10N	ACTIVE	PDIP	N	14	25	RoHS & Green	NIPDAU	N / A for Pkg Type	0 to 70	SN74S10N	Samples
SNJ54LS10FK	ACTIVE	LCCC	FK	20	55	Non-RoHS & Green	SNPB	N / A for Pkg Type	-55 to 125	SNJ54LS10FK	Samples
SNJ54LS10J	ACTIVE	CDIP	J	14	25	Non-RoHS & Green	SNPB	N / A for Pkg Type	-55 to 125	SNJ54LS10J	Samples
SNJ54LS10W	ACTIVE	CFP	W	14	25	Non-RoHS & Green	SNPB	N / A for Pkg Type	-55 to 125	SNJ54LS10W	Samples
SNJ54S10J	ACTIVE	CDIP	J	14	25	Non-RoHS & Green	SNPB	N / A for Pkg Type	-55 to 125	SNJ54S10J	Samples
SNJ54S10W	ACTIVE	CFP	W	14	25	Non-RoHS & Green	SNPB	N / A for Pkg Type	-55 to 125	SNJ54S10W	Samples

(1) The marketing status values are defined as follows:

ACTIVE: Product device recommended for new designs.

LIFEBUY: TI has announced that the device will be discontinued, and a lifetime-buy period is in effect.

NRND: Not recommended for new designs. Device is in production to support existing customers, but TI does not recommend using this part in a new design.

PREVIEW: Device has been announced but is not in production. Samples may or may not be available.

OBSOLETE: TI has discontinued the production of the device.

(2) **RoHS:** TI defines "RoHS" to mean semiconductor products that are compliant with the current EU RoHS requirements for all 10 RoHS substances, including the requirement that RoHS substance do not exceed 0.1% by weight in homogeneous materials. Where designed to be soldered at high temperatures, "RoHS" products are suitable for use in specified lead-free processes. TI may reference these types of products as "Pb-Free".

RoHS Exempt: TI defines "RoHS Exempt" to mean products that contain lead but are compliant with EU RoHS pursuant to a specific EU RoHS exemption.

Green: TI defines "Green" to mean the content of Chlorine (Cl) and Bromine (Br) based flame retardants meet JS709B low halogen requirements of <=1000ppm threshold. Antimony trioxide based flame retardants must also meet the <=1000ppm threshold requirement.

(3) MSL, Peak Temp. - The Moisture Sensitivity Level rating according to the JEDEC industry standard classifications, and peak solder temperature.

(4) There may be additional marking, which relates to the logo, the lot trace code information, or the environmental category on the device.

(5) Multiple Device Markings will be inside parentheses. Only one Device Marking contained in parentheses and separated by a "~" will appear on a device. If a line is indented then it is a continuation of the previous line and the two combined represent the entire Device Marking for that device.

⁽⁶⁾ Lead finish/Ball material - Orderable Devices may have multiple material finish options. Finish options are separated by a vertical ruled line. Lead finish/Ball material values may wrap to two lines if the finish value exceeds the maximum column width.

Important Information and Disclaimer:The information provided on this page represents TI's knowledge and belief as of the date that it is provided. TI bases its knowledge and belief on information provided by third parties, and makes no representation or warranty as to the accuracy of such information. Efforts are underway to better integrate information from third parties. TI has taken and continues to take reasonable steps to provide representative and accurate information but may not have conducted destructive testing or chemical analysis on incoming materials and chemicals. TI and TI suppliers consider certain information to be proprietary, and thus CAS numbers and other limited information may not be available for release.

In no event shall TI's liability arising out of such information exceed the total purchase price of the TI part(s) at issue in this document sold by TI to Customer on an annual basis.

OTHER QUALIFIED VERSIONS OF SN54LS10, SN54LS10-SP, SN54S10, SN74LS10, SN74S10 :

- Catalog : [SN74LS10](#), [SN54LS10](#), [SN74S10](#)

- Military : [SN54LS10](#), [SN54S10](#)

- Space : [SN54LS10-SP](#)

NOTE: Qualified Version Definitions:

- Catalog - TI's standard catalog product

- Military - QML certified for Military and Defense Applications

- Space - Radiation tolerant, ceramic packaging and qualified for use in Space-based application

TAPE AND REEL INFORMATION

QUADRANT ASSIGNMENTS FOR PIN 1 ORIENTATION IN TAPE

*All dimensions are nominal

Device	Package Type	Package Drawing	Pins	SPQ	Reel Diameter (mm)	Reel Width W1 (mm)	A0 (mm)	B0 (mm)	K0 (mm)	P1 (mm)	W (mm)	Pin1 Quadrant
SN74LS10DR	SOIC	D	14	2500	330.0	16.4	6.5	9.0	2.1	8.0	16.0	Q1
SN74LS10NSR	SO	NS	14	2000	330.0	16.4	8.2	10.5	2.5	12.0	16.0	Q1

TAPE AND REEL BOX DIMENSIONS



*All dimensions are nominal

Device	Package Type	Package Drawing	Pins	SPQ	Length (mm)	Width (mm)	Height (mm)
SN74LS10DR	SOIC	D	14	2500	356.0	356.0	35.0
SN74LS10NSR	SO	NS	14	2000	356.0	356.0	35.0

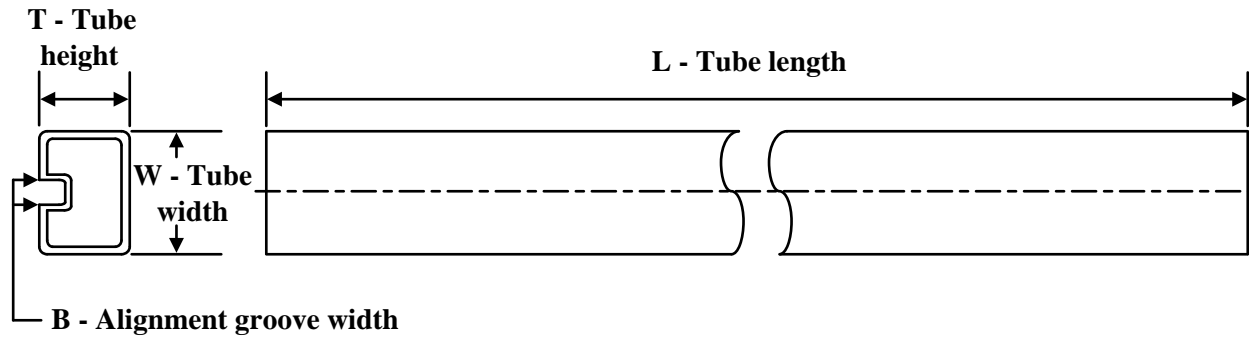
TUBE

*All dimensions are nominal

Device	Package Name	Package Type	Pins	SPQ	L (mm)	W (mm)	T (μm)	B (mm)
JM38510/07005BDA	W	CFP	14	25	506.98	26.16	6220	NA
JM38510/30005B2A	FK	LCCC	20	55	506.98	12.06	2030	NA
JM38510/30005BDA	W	CFP	14	25	506.98	26.16	6220	NA
JM38510/30005SDA	W	CFP	14	25	506.98	26.16	6220	NA
M38510/07005BDA	W	CFP	14	25	506.98	26.16	6220	NA
M38510/30005B2A	FK	LCCC	20	55	506.98	12.06	2030	NA
M38510/30005BDA	W	CFP	14	25	506.98	26.16	6220	NA
M38510/30005SDA	W	CFP	14	25	506.98	26.16	6220	NA
SN74LS10N	N	PDIP	14	25	506	13.97	11230	4.32
SN74LS10N	N	PDIP	14	25	506	13.97	11230	4.32
SN74S10N	N	PDIP	14	25	506	13.97	11230	4.32
SN74S10N	N	PDIP	14	25	506	13.97	11230	4.32
SNJ54LS10FK	FK	LCCC	20	55	506.98	12.06	2030	NA
SNJ54LS10W	W	CFP	14	25	506.98	26.16	6220	NA

MECHANICAL DATA

NS (R-PDSO-G**)

PLASTIC SMALL-OUTLINE PACKAGE

14-PINS SHOWN



- NOTES:
- A. All linear dimensions are in millimeters.
 - B. This drawing is subject to change without notice.
 - C. Body dimensions do not include mold flash or protrusion, not to exceed 0,15.

W (R-GDFP-F14)

CERAMIC DUAL FLATPACK



- NOTES:
- A. All linear dimensions are in inches (millimeters).
 - B. This drawing is subject to change without notice.
 - C. This package can be hermetically sealed with a ceramic lid using glass frit.
 - D. Index point is provided on cap for terminal identification only.
 - E. Falls within MIL STD 1835 GDFP1-F14

GENERIC PACKAGE VIEW

FK 20

LCCC - 2.03 mm max height

8.89 x 8.89, 1.27 mm pitch

LEADLESS CERAMIC CHIP CARRIER

This image is a representation of the package family, actual package may vary.
Refer to the product data sheet for package details.



4229370VA\

J 14

GENERIC PACKAGE VIEW
CDIP - 5.08 mm max height
CERAMIC DUAL IN LINE PACKAGE



Images above are just a representation of the package family, actual package may vary.
Refer to the product data sheet for package details.

4040083-5/G

J0014A



PACKAGE OUTLINE

CDIP - 5.08 mm max height

CERAMIC DUAL IN LINE PACKAGE



4214771/A 05/2017

NOTES:

1. All controlling linear dimensions are in inches. Dimensions in brackets are in millimeters. Any dimension in brackets or parenthesis are for reference only. Dimensioning and tolerancing per ASME Y14.5M.
2. This drawing is subject to change without notice.
3. This package is hermetically sealed with a ceramic lid using glass frit.
4. Index point is provided on cap for terminal identification only and on press ceramic glass frit seal only.
5. Falls within MIL-STD-1835 and GDIP1-T14.

EXAMPLE BOARD LAYOUT

J0014A

CDIP - 5.08 mm max height

CERAMIC DUAL IN LINE PACKAGE



LAND PATTERN EXAMPLE
NON-SOLDER MASK DEFINED
SCALE: 5X



4214771/A 05/2017

D (R-PDSO-G14)

PLASTIC SMALL OUTLINE

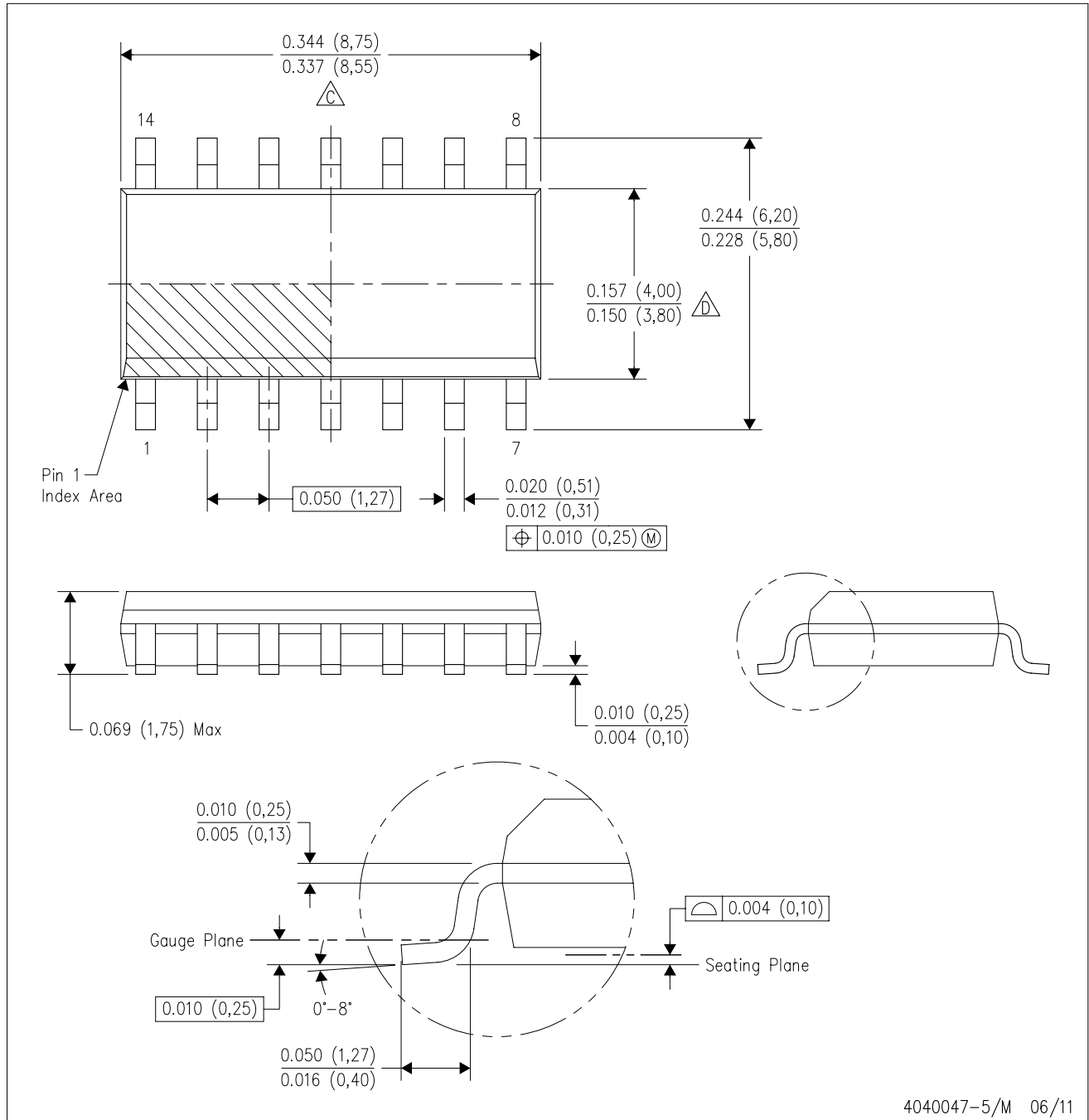

- NOTES:
- A. All linear dimensions are in inches (millimeters).
 - B. This drawing is subject to change without notice.
 - △C Body length does not include mold flash, protrusions, or gate burrs. Mold flash, protrusions, or gate burrs shall not exceed 0.006 (0,15) each side.
 - △D Body width does not include interlead flash. Interlead flash shall not exceed 0.017 (0,43) each side.
 - E. Reference JEDEC MS-012 variation AB.

D (R-PDSO-G14)

PLASTIC SMALL OUTLINE



- NOTES:
- A. All linear dimensions are in millimeters.
 - B. This drawing is subject to change without notice.
 - C. Publication IPC-7351 is recommended for alternate designs.
 - D. Laser cutting apertures with trapezoidal walls and also rounding corners will offer better paste release. Customers should contact their board assembly site for stencil design recommendations. Refer to IPC-7525 for other stencil recommendations.
 - E. Customers should contact their board fabrication site for solder mask tolerances between and around signal pads.

N (R-PDIP-T**)

PLASTIC DUAL-IN-LINE PACKAGE

16 PINS SHOWN



- NOTES:
- A. All linear dimensions are in inches (millimeters).
 - B. This drawing is subject to change without notice.
 - Falls within JEDEC MS-001, except 18 and 20 pin minimum body length (Dim A).
 - The 20 pin end lead shoulder width is a vendor option, either half or full width.

IMPORTANT NOTICE AND DISCLAIMER

TI PROVIDES TECHNICAL AND RELIABILITY DATA (INCLUDING DATA SHEETS), DESIGN RESOURCES (INCLUDING REFERENCE DESIGNS), APPLICATION OR OTHER DESIGN ADVICE, WEB TOOLS, SAFETY INFORMATION, AND OTHER RESOURCES "AS IS" AND WITH ALL FAULTS, AND DISCLAIMS ALL WARRANTIES, EXPRESS AND IMPLIED, INCLUDING WITHOUT LIMITATION ANY IMPLIED WARRANTIES OF MERCHANTABILITY, FITNESS FOR A PARTICULAR PURPOSE OR NON-INFRINGEMENT OF THIRD PARTY INTELLECTUAL PROPERTY RIGHTS.

These resources are intended for skilled developers designing with TI products. You are solely responsible for (1) selecting the appropriate TI products for your application, (2) designing, validating and testing your application, and (3) ensuring your application meets applicable standards, and any other safety, security, regulatory or other requirements.

These resources are subject to change without notice. TI grants you permission to use these resources only for development of an application that uses the TI products described in the resource. Other reproduction and display of these resources is prohibited. No license is granted to any other TI intellectual property right or to any third party intellectual property right. TI disclaims responsibility for, and you will fully indemnify TI and its representatives against, any claims, damages, costs, losses, and liabilities arising out of your use of these resources.

TI's products are provided subject to [TI's Terms of Sale](#) or other applicable terms available either on [ti.com](https://www.ti.com) or provided in conjunction with such TI products. TI's provision of these resources does not expand or otherwise alter TI's applicable warranties or warranty disclaimers for TI products.

TI objects to and rejects any additional or different terms you may have proposed.

Mailing Address: Texas Instruments, Post Office Box 655303, Dallas, Texas 75265
Copyright © 2024, Texas Instruments Incorporated

Looking for pricing, stock, or lifecycle information?

Click below to explore more details on WIN SOURCE:

- ⊖ [View SG2803L-883B on WIN SOURCE](#)
- ⊖ [Microchip Technology](#) Information

Optimize Your Supply Chain with WIN SOURCE Solutions

- ✓ Global Sourcing Solution
- ✓ Obsolete Management
- ✓ Cost Control Management
- ✓ Shortage Management
- ✓ Alternative Solution
- ✓ Excess Inventory Management