



**THE DATASHEET OF  
EC12.1101.001**



IEC Appliance Inlet C20 with Filter, Line Switch 2-pole



See below:  
[Approvals and Compliances](#)

**Description**

- Panel mount :  
 Snap-in or screw-on mounting front side
- 3 Functions :  
 Appliance Inlet Protection class I , Line Switch 2-pole , Line filter in standard and medical version
- Quick connect terminals 6.3 x 0.8 mm

**Unique Selling Proposition**

- Compact size
- Switch for highest inrush current
- Optional with enhanced surge withstand voltage
- V-Lock cord retaining

**Characteristics**

- All single elements are already wired
- Line switch non-illuminated
- With EMC-shield
- Ideal for application with high transient loads
- For applications according IEC/UL 62368-1 we recommend variants with bleed resistor  
 Suitable for use in medical equipment according to IEC/UL 60601-1 (1 MOOP, 1 MOPP)

**Other versions on request**

- Line switch, illuminated
- Line switch with other rocker marking
- Variant with notch for V-Lock mating Cordsets

**References**

Alternative: version without line filter [EC11](#)  
 Alternative: Standard version

**Weblinks**

[pdf data sheet](#), [html datasheet](#), [General Product Information](#), [Approvals](#), [Distributor-Stock-Check](#), [Accessories](#), [Detailed request for product](#)

Newly available variants corresponding to V-Lock mating cordset. The connector is equipped with a notch intended for use with the latching cordset. The cord latching system prevents against accidental removal of the cordset.

**Technical Data**

Ratings IEC	12 - 16A @ Ta 40 °C / 250VAC; 50Hz	Appliance inlet/-outlet	C20 acc. to IEC 60320-1, UL 498, CSA C22.2 no. 42 (for cold conditions) pin-temperature 70 °C, 16A, Protection Class I
Ratings UL/CSA	12 - 20A @ Ta 40 °C / 250VAC; 60Hz	Line Switch	Rocker switch 2-pole, non-illuminated, acc. to IEC 61058-1 <a href="#">Technical Details</a>
Leakage Current	standard < 0.5mA (250V / 60Hz) medical < 5 µA (250 V / 60 Hz)	Line Filter	Standard and Medical Version, IEC 60939, UL 1283, CSA C22.2 no. 8 <a href="#">Technical Details</a>
Dielectric Strength	> 1.7kVDC between L-N > 2.7kVDC between L/N-PE Test voltage (2 sec)	MTBF	> 1'700'000h acc. to MIL-HB-217 F
Allowable Operation Temperature	-25 °C to 85 °C		
Climatic Category	25/085/21 acc. to IEC 60068-1		
IP-Protection	front side IP40 acc. to IEC 60529		
Protection Class	Suitable for appliances with protection class I acc. to IEC 61140		
Terminal	Quick connect terminals 6.3 x 0.8 mm		
Panel Thickness S	Screw: max 8 mm Mounting screw torque max 0.5Nm		
Material	Thermoplastic, black, UL 94V-0		

**Approvals and Compliances**



Detailed information on product approvals, code requirements, usage instructions and detailed test conditions can be looked up in [Details about Approvals](#)

SCHURTER products are designed for use in industrial environments. They have approvals from independent testing bodies according to national and international standards. Products with specific characteristics and requirements such as required in the automotive sector according to IATF 16949, medical technology according to ISO 13485 or in the aerospace industry can be offered exclusively with customer-specific, individual agreements by SCHURTER.

## Approvals







The approval mark is used by the testing authorities to certify compliance with the safety requirements placed on electronic products.

Approval Reference Type: EC12

Approval Logo	Certificates	Certification Body	Description
	<a href="#">VDE Approvals</a>	VDE	Certificate Number: 40001522
	<a href="#">UL Approvals</a>	UL	UR File Number: E72928
	<a href="#">CQC Approvals</a>	CQC	CQC Certificate Number: CQC21001327399



## Product standards

Product standards that are referenced

Organization	Design	Standard	Description
	Designed according to	IEC 60320-1	Appliance couplers for household and similar general purposes
	Designed according to	IEC 60939	Passive filters for suppressing electromagnetic interference
	Designed according to	IEC 61058-1	Switches for appliances. Part 1. General requirements
	Designed according to	UL 498	Standard for Attachment Plugs and Receptacles
	Designed according to	UL 1283	Passive filters for suppressing electromagnetic interference
	Designed according to	CSA C22.2 no. 42	General Use Receptacles, Attachment Plugs, and Similar Wiring Devices
	Designed according to	CSA C22.2 no. 8	Electromagnetic interference (EMI) filters







## Application standards

Application standards where the product can be used

Organization	Design	Standard	Description
	Suitable for applications acc.	IEC/UL 62368-1	Audio/video, information and communication technology equipment - Part 1: Safety requirements
	Suitable for applications acc.	IEC 60601-1	Medical electrical equipment - Part 1: General requirements for basic safety and essential performance

### Compliances

The product complies with following Guide Lines

Identification	Details	Initiator	Description
	<a href="#">CE declaration of conformity</a>	SCHURTER AG	The CE marking declares that the product complies with the applicable requirements laid down in the harmonisation of Community legislation on its affixing in accordance with EU Regulation 765/2008.
	<a href="#">UKCA declaration of conformity</a>	SCHURTER AG	The UKCA marking declares that the product complies with the applicable requirements laid down in the British Amendment of Regulation (EC) 765/2008.
	RoHS	SCHURTER AG	Directive RoHS 2011/65/EU, Amendment (EU) 2015/863
	China RoHS	SCHURTER AG	The law SJ / T 11363-2006 (China RoHS) has been in force since 1 March 2007. It is similar to the EU directive RoHS.
	REACH	SCHURTER AG	On 1 June 2007, Regulation (EC) No 1907/2006 on the Registration, Evaluation, Authorization and Restriction of Chemicals 1 (abbreviated as "REACH") entered into force.
		SCHURTER AG	V-Lock system are based on a matching plug-dose combination. The connector is equipped with a notch intended for use with the latching cordset. The cord latching system prevents against accidental removal of the cordset.
	Medical Equipment	SCHURTER AG	Suitable for use in medical equipment according to IEC/UL 60601-1 (1 MOOP, 1 MOPP)

### Dimension [mm]

EC12

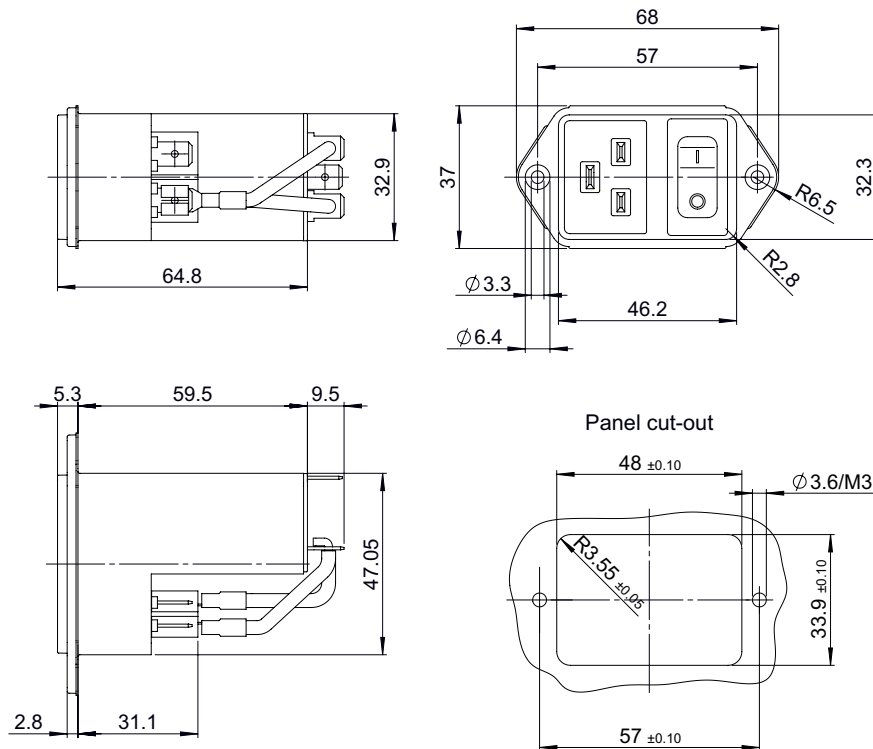

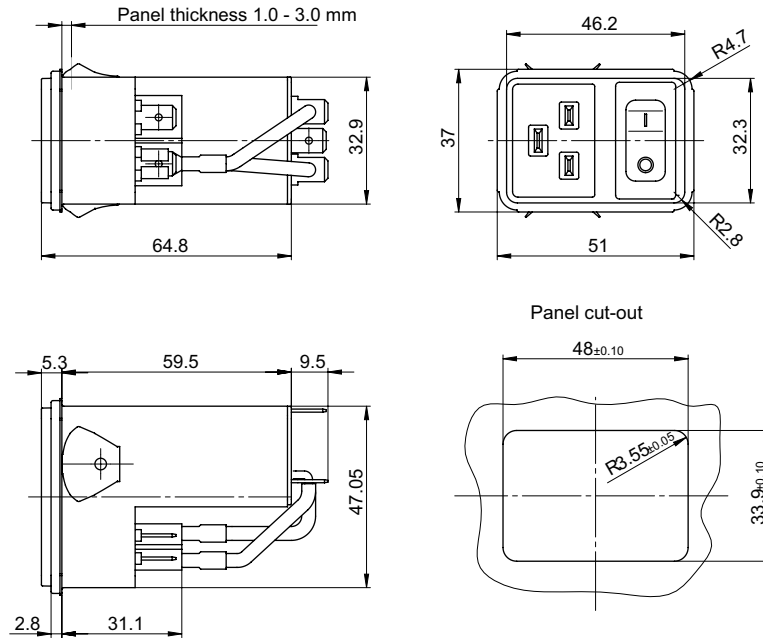

**Technical Data of Filter-Components**

Rated Current [A]	Filter-Type	Inductances L [mH]	Capacitance CX [nF]	Capacitance CY [nF]	R [MΩ]
12	Standard version	2 x 0.8	100	2.2	1
16	Standard version	2 x 0.6	100	2.2	1
20	Standard version	2 x 0.3	100	2.2	1
12	Medical Version (M5)	2 x 0.8	100	-	1
16	Medical Version (M5)	2 x 0.6	100	-	1
20	Medical Version (M5)	2 x 0.3	100	-	1

**Diagrams**

Standard version

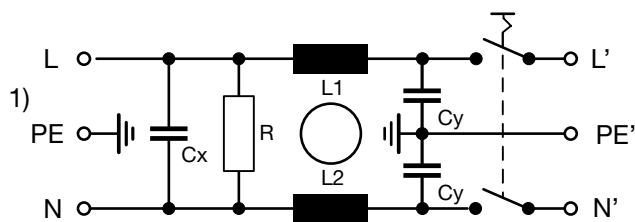

1) Line  
 2) Load

Medical Version (M5)

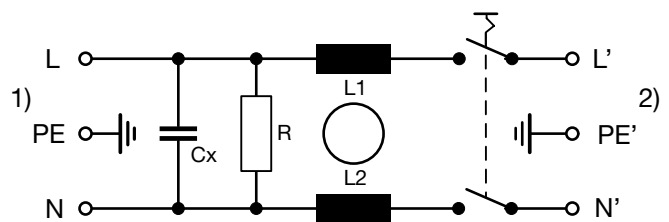

1) Line  
 2) Load

**Attenuation Loss**

--- 50Ω differential mode    \_\_\_\_ 50Ω common mode

Standard version

12 A

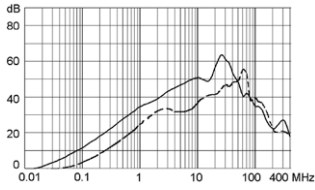

16 A

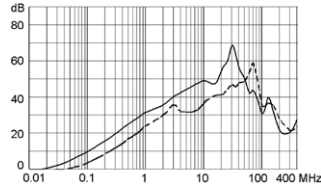

20 A

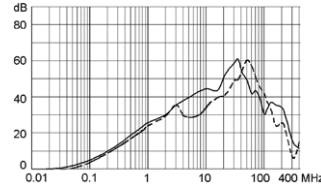

Medical version (M5)

12 A

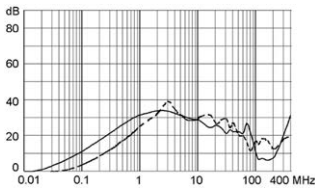

16 A

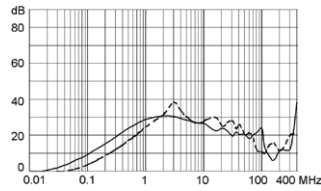

20 A

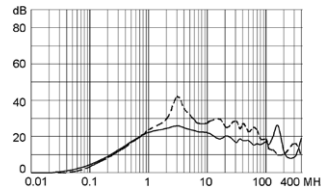

**All Variants**

Rated Current [A]	Filter-Type	Panel mounting	Internally wired	Line Switch	V-Lock	Order Number
16	Standard version	Snap-in	●	2-pole		3-136-814
20	Standard version	Snap-in	●	2-pole		3-136-812
12	Standard version	Screw	●	2-pole		EC12.3101.001
12	Standard version	Screw	●	2-pole	●	EC12.3101.001.21
16	Standard version	Screw	●	2-pole		EC12.2101.001
20	Standard version	Screw	●	2-pole		EC12.1101.001
12	Standard version	Screw		2-pole		EC12.3101.002
16	Standard version	Screw		2-pole		EC12.2101.002
20	Standard version	Screw		2-pole		EC12.1101.002
16	Medical Version (M5)	Snap-in	●	2-pole		3-136-815
20	Medical Version (M5)	Snap-in	●	2-pole		3-136-813
12	Medical Version (M5)	Screw	●	2-pole		EC12.3201.001
16	Medical Version (M5)	Screw	●	2-pole		EC12.2201.001
16	Medical Version (M5)	Screw	●	2-pole	●	EC12.2201.001.21
20	Medical Version (M5)	Screw	●	2-pole		EC12.1201.001
12	Medical Version (M5)	Screw		2-pole		EC12.3201.002
16	Medical Version (M5)	Screw		2-pole		EC12.2201.002
20	Medical Version (M5)	Screw		2-pole		EC12.1201.002

Most Popular.

Availability for all products can be searched real-time: <https://www.schurter.com/en/info-center/support-tools/stock-check-distributors>

**Packaging unit**

20 Pcs

Accessories

Description



[Wire\\_Harness](#)  
 Wire harness for SCHURTER products



[Assorted\\_Covers](#)  
 Rear Cover

0859.0108



[Cord\\_retaining\\_kits](#)  
 Cord retaining strain relief

Flat head, H

4700.0008

Mating Outlets/Connectors

Category / Description



[Connector Overview complete](#)

4795, Mounting: Power Cord, Cable Connector: IEC C19

4795

4790, Mounting: Power Cord, Screw Connector: IEC C19

4790

0104U, Mounting: Power Supply Cord, Screw clamps Connector: IEC C19

0104U

Mating Outlets/Connectors shuttered





[Power Cord Overview complete](#)

VAC19KS, Overview, V-Lock cord retaining, diverse Connector IEC C19, diverse, black

VAC19KS

## Looking for pricing, stock, or lifecycle information?

Click below to explore more details on WIN SOURCE:

-  [View EC12.1101.001 on WIN SOURCE](#)
-  [Schurter Inc. Information](#)

## Optimize Your Supply Chain with WIN SOURCE Solutions

-  Global Sourcing Solution
-  Obsolete Management
-  Cost Control Management
-  Shortage Management
-  Alternative Solution
-  Excess Inventory Management