



**THE DATASHEET OF  
EM2040N01QI**



# Intel® Enpirion® Power Solutions

## EM2040N01QI 40A PowerSoC

### Step-Down DC-DC Switching Converter with Integrated Inductor

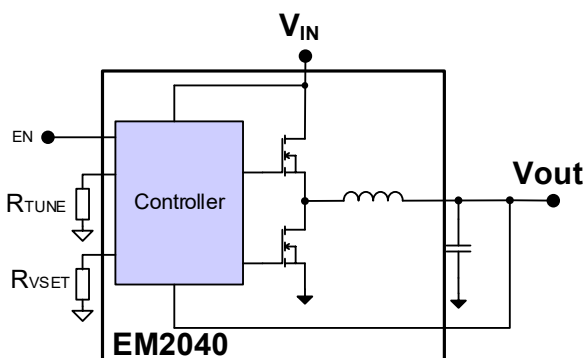
#### Description

The EM2040 is a fully integrated 40A PowerSoC synchronous buck converter with digital non-linear control loop. It features an advanced controller, gate drivers, synchronous MOSFET switches, and a high performance inductor. Only input and output filter capacitors and a few small signal components are required for a complete solution. The digital loop enables a reduction in output bulk filter capacitors.

Differential remote sensing and  $\pm 0.5\%$  set-point accuracy provides precise regulation over line, load and temperature variation. Very low ripple further reduces accuracy uncertainty to provide best in class static regulation for today's FPGAs, ASICs, processors, and DDR memory devices.

The EM2040 features high conversion efficiency and superior thermal performance to minimize thermal de-rating limitations, which is key to product reliability and longevity.

#### Simplified Block Diagram

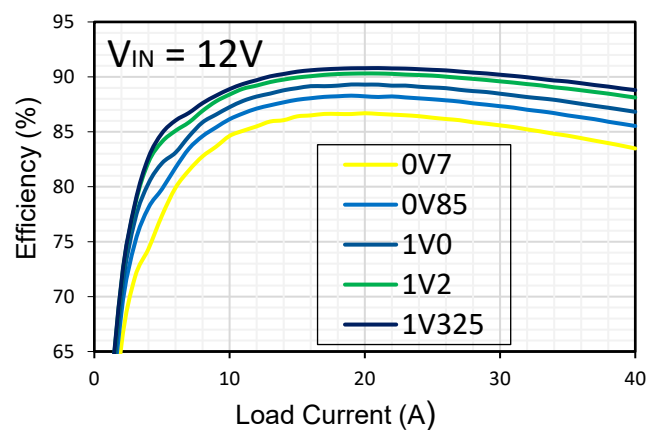


#### Features

- Integrated inductor, FETs, and controller
- Wide 4.5V to 16V  $V_{IN}$  range
- 0.5V to 1.325V  $V_{OUT}$  range
- 11mm x 17mm x 6.76mm QFN package
  - 90% efficiency at  $V_{IN} = 12V, V_{OUT} = 1.2V$
- Optimized total solution size of only 365 mm<sup>2</sup>
- Meets all high performance FPGA requirements
  - 0.5% set-point over line, load, and temperature
  - Output ripple as low as 10 mV peak-peak
  - Differential remote sensing
- RVSET resistor for programmable  $V_{OUT}$
- RTUNE resistor for single resistor compensation
- Tracking pin for complex sequencing
- RoHS compliant, MSL level 3, 260°C reflow

#### Applications

- High performance FPGA supply rails
- ASIC and processor supply rails
- High density double data rate (DDR) memory VDDQ rails



## Ordering Information

Table 1

| Part Number | Supported V <sub>OUT</sub> Range | Package Markings | Package Description   |
|-------------|----------------------------------|------------------|---|
| EM2040N01QI | 0.5V to 1.325V                   | M2040            | 17 mm x 11 mm x 6.76 mm QFN104 provided in 112 units per tray |

**Packing and Marking Information:** [www.altera.com/support/reliability/packing/rel-packing-and-marking.html](http://www.altera.com/support/reliability/packing/rel-packing-and-marking.html)

## Pin Assignments

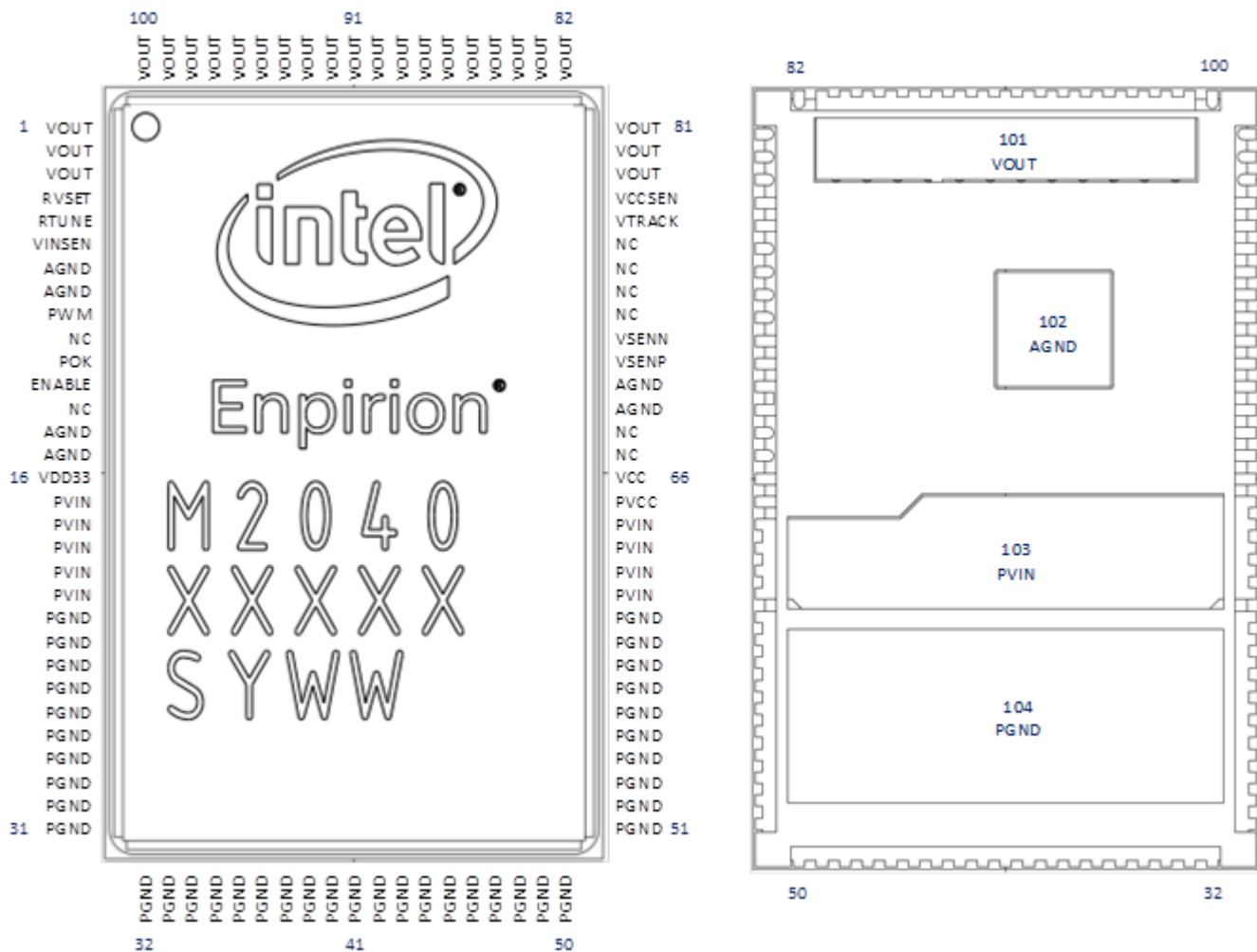


Figure 1: Pin Out Diagram

## Pin Description

Table 2

| PIN                             | NAME   | I/O              | FUNCTION  |
|---------------------------------|--------|------------------|---|
| 1,2,3,<br>79-101                | VOUT   | Regulated Output | Regulated output voltage. Decouple to PGND with appropriate filter capacitors   |
| 4                               | RVSET  | Analog I/O       | A resistor from RVSET to AGND; and can be used to program the $V_{OUT}$ set-point. Using 1% tolerance or better resistor. See <a href="#">Table 8</a> for more information.                                     |
| 5                               | RTUNE  | Analog I/O       | A resistor from RTUNE to AGND; and can be used to tune the transient compensator for the amount of output capacitance. Using 1% tolerance or better resistor. See <a href="#">Table 9</a> for more information. |
| 6                               | VINSEN | Analog Input     | Single-ended input voltage sense (relative to AGND).  |
| 7, 8, 14,<br>15, 69,<br>70, 102 | AGND   | Ground           | Analog ground. Connect to system ground plane. Refer to layout section for more details on grounding.   |
| 9                               | PWM    | PWM              | PWM signal test pin.  |
| 10, 13,<br>67,68,<br>73-76      | NC     | NC               | No connect. Do not connect to any signal, supply, or ground.  |
| 11                              | POK    | Input            | Power OK signal. Open Drain Output  |
| 12                              | ENABLE | Input            | A high on the ENABLE Pin will result in the Vout rising. ENABLE should never be left floating..   |
| 16                              | VDD33  | Output           | 3.3V output of the internal LDO. May be used as pull-up supply ENABLE pin.  |
| 17-21,<br>61-64,<br>103         | PVIN   | Input Supply     | Input supply for MOSFET switches. Decouple to PGND with appropriate filter capacitors. Refer to Recommended Application Circuit section for more details.   |
| 22-60,<br>104                   | PGND   | Ground           | Power ground. Ground for MOSFET switches.   |
| 65                              | PVCC   | Input Supply     | 5.0V supply voltage for driver circuitry. Decouple to PGND using a 2.2 $\mu$ F MLCC high quality ceramic capacitor.   |
| 66                              | VCC    | Input Supply     | 5.0V supply voltage for analog circuitry.   |
| 71                              | VSENP  | Analog Input     | Differential output voltage sense input (positive).   |
| 72                              | VSENN  | Analog Input     | Differential output voltage sense input (negative).   |
| 77                              | VTRACK | Analog Input     | Voltage tracking reference input. Vout will track applied signal. If not used, it <b>cannot be left floating</b> but should be connected to VDD33 using a 10k $\Omega$ resistor.                                |
| 78                              | VCCSEN | Analog Input     | Single-ended VCC voltage sense (relative to AGND)   |

## Absolute Maximum Ratings

**CAUTION:** Absolute Maximum ratings are stress ratings only. Functional operation beyond the recommended operating conditions is not implied. Stress beyond the absolute maximum ratings may impair device life. Exposure to absolute maximum rated conditions for extended periods may affect device reliability. Voltage measurements are referenced to AGND.

## Absolute Maximum Pin Ratings

Table 3

| PARAMETER           | SYMBOL                               | MIN  | MAX  | UNITS |
|---------------------|--------------------------------------|------|------|-------|
| Supply voltage PVIN | PVIN                                 | -0.3 | 18   | V     |
| Supply voltage VCC  | VCC                                  | -0.3 | 5.5  | V     |
| VCC ramp time       | VCC                                  |      | 20   | ms    |
| VDD33               | VDD33                                | -0.3 | 3.6  | V     |
| Power ground        | PGND                                 | -0.3 | 0.3  | V     |
| I/O pins            | VINSEN, VCCSEN, RVSET, RTUNE, VTRACK | -0.3 | 2.0  | V     |
| I/O pin             | ENABLE                               | -0.3 | 3.6  | V     |
| I/O pin             | POK                                  | -0.3 | 5.5  | V     |
| Voltage feedback    | VSENP, VSENN                         | -0.3 | 2.0  | V     |
| PWM pin             | PWM                                  | -0.3 | 5.5  | V     |
| Output voltage pins | VOUT                                 | -0.3 | 1.44 | V     |
| DC current on VOUT  | VOUT                                 |      | 43   | A     |

## Absolute Maximum Thermal Ratings

| PARAMETER                      | CONDITION     | MIN | MAX  | UNITS |
|--------------------------------|---------------|-----|------|-------|
| Operating junction temperature |               |     | +125 | °C    |
| Storage temperature range      |               | -65 | +150 | °C    |
| Reflow peak body temperature   | (10 Sec) MSL3 |     | +260 | °C    |

## Absolute Maximum ESD Ratings

| PARAMETER     | CONDITION                          | MIN  | MAX | UNITS |
|---------------|------------------------------------|------|-----|-------|
| HBD           | All pins; Except VINSEN 1000 V Max | 2000 |     | V     |
| CDM; all pins |                                    | 500  |     | V     |

## Recommended Operating Conditions

Table 4

| PARAMETER                              | PINS      | MIN  | MAX  | UNITS |
|--|-----------|------|------|-------|
| PVIN supply voltage range              | PVIN      | 4.5  | 16   | V     |
| Supply voltage $V_{CC}$ & $PV_{CC}$    | VCC, PVCC | 4.75 | 5.25 | V     |
| Continuous load current                | $V_{OUT}$ |      | 40   | A     |
| Junction Temperature ( <i>Note 1</i> ) |           | -40  | 125  | °C    |

(*Note 1*): OTP default is set to 120°C for safety margin

## Thermal Characteristics

Table 5

| PARAMETER   | PINS          | TYPICAL | UNITS |
|---|---------------|---------|-------|
| Thermal shutdown  | $T_{SD}$      | 120     | °C    |
| Thermal shutdown Hysteresis   | $T_{SDH}$     | 18      | °C    |
| Thermal resistance: junction to ambient (0 LFM)<br>( <i>Note1</i> ) | $\theta_{JA}$ | 8       | °C/W  |
| Thermal resistance: junction to case bottom (0 LFM)                 | $\theta_{JC}$ | 1.5     | °C/W  |

**Note1:** Based on 2 oz. external copper layers and proper thermal design in line with EIJ/JEDEC JESD51 standards for high thermal conductivity boards. No top side cooling required.

## Electrical Characteristics

$PV_{IN} = 12V$  and  $V_{CC} = 5.0V$ . The minimum and maximum values are over the ambient temperature range (-40°C to 85°C) unless otherwise noted. Typical values are at  $T_A = 25^\circ C$ .

**Table 6**

| PARAMETER                                  | SYMBOL | TEST CONDITIONS                                | MIN  | TYP            | MAX     | UNITS   |
|--|--------|--|------|----------------|---------|---------|
| <b>SUPPLY CHARACTERISTICS</b>              |        |  |      |                |         |         |
| PVIN supply voltage range                  | PVIN   |  | 4.5  |                | 16      | V       |
| PVIN supply quiescent current              |        | Device switching; no load;<br>$V_{OUT} = 1.0V$ |      | 40             |         | mA      |
|  |        | Device not switching                           |      | 1              |         |         |
| VCC supply voltage range                   | VCC    |  | 4.75 | 5.0            | 5.25    | V       |
| VCC UVLO rising                            |        |  |      | 4.4            |         | V       |
| VCC UVLO falling                           |        |  |      | 4.2            |         | V       |
| PVCC & VCC supply current                  |        | Normal operation; no load;                     |      | 80<br>(Note 1) |         | mA      |
|  |        | Idle; no switching                             |      | 30             |         |         |
|  |        | Disabled ( $V_{CC} \leq 2.8V$ )                |      | 900            |         |         |
| <b>INTERNALLY GENERATED SUPPLY VOLTAGE</b> |        |  |      |                |         |         |
| VDD33 voltage range                        | VDD33  |  | 3.0  | 3.3            | 3.6     |         |
| VDD33 output current                       |        |  |      |                | 2       | mA      |
| <b>Open Drain PIN (POK)</b>                |        |  |      |                |         |         |
| Input low voltage                          |        |  | 0    |                | 0.8     | V       |
| Input leakage current                      |        |  |      |                | $\pm 1$ | $\mu A$ |
| Output current - sink                      |        |  |      |                | 2.0     | mA      |
| <b>I/O PIN (ENABLE)</b>                    |        |  |      |                |         |         |
| Input high voltage                         |        |  | 2.0  |                | 3.6     | V       |
| Input low voltage                          |        |  | -0.3 |                | 0.8     | V       |
| ENABLE response delay                      |        | Off - Low                                      |      | 150            |         | $\mu s$ |
| ENABLE response delay                      |        | On - High                                      |      | 250            |         | $\mu s$ |
| <b>I/O PINS (VINSEN, VCCSEN)</b>           |        |  |      |                |         |         |
| Input voltage                              |        |  | 0    |                | 1.4     | V       |
| <b>I/O PIN PWM</b>                         |        |  |      |                |         |         |
| PWM output voltage                         |        | High   | 2.4  |                |         | V       |
| PWM output voltage                         |        | Low  |      |                | 0.4     | V       |

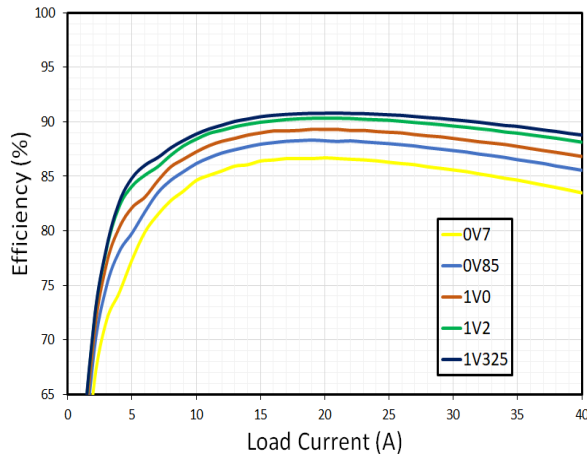
| PARAMETER                                   | SYMBOL   | TEST CONDITIONS                                      | MIN  | TYP   | MAX   | UNITS |
|---|----------|--|------|-------|-------|-------|
| PWM tristate leakage                        |          |  |      |       | ±1    | μA    |
| PWM pulse width                             |          |  | 30   |       |       | ns    |
| Resolution                                  |          |  |      | 163   |       | ps    |
| Switching frequency                         | $f_{sw}$ |  |      | 800   |       | kHz   |
| <b>I/O PIN VTRACK</b>                       |          |  |      |       |       |       |
| VTRACK ramp rate                            |          |  |      |       | 2.0   | V/ms  |
| VTRACK range                                |          |  | 0    |       | 1.4   | V     |
| VTRACK offset voltage                       |          |  |      | ±100  |       | mV    |
| <b>OUTPUT VOLTAGE</b>                       |          |  |      |       |       |       |
| Output voltage adjustment range             |          |  | 0.5  |       | 1.325 | V     |
| Output voltage set-point accuracy           |          | $0^{\circ}\text{C} < T_A < 85^{\circ}\text{C}$       | -0.5 |       | +0.5  | %     |
|   |          | $-40^{\circ}\text{C} < T_A < 85^{\circ}\text{C}$     | -1   |       | +1    | %     |
| Output set-point resolution                 |          |  |      | 1.5   |       | mV    |
| Line regulation                             |          |  |      | 0.007 |       | mV/V  |
| Load regulation                             |          |  |      | 0.07  |       | mV/A  |
| Output voltage startup delay                |          | From $V_{CC}$ valid, to start of output voltage ramp |      | 5     |       | ms    |
| Rise Time                                   |          | VTRACK not used (tied high)                          |      | 0.18  |       | V/ms  |
| Fall Time                                   |          | VTRACK not used (tied high)                          |      | 0.18  |       | V/ms  |
| <b>FAULT MANAGEMENT PROTECTION FEATURES</b> |          |  |      |       |       |       |
| $PV_{IN}$ UV threshold                      |          |  |      | 4     |       | V     |
| $PV_{IN}$ OV threshold                      |          |  |      | 16.4  |       | V     |
| $V_{OUT}$ OV threshold                      |          | Percentage of output voltage                         |      | 120   |       | %     |
| $V_{OUT}$ UV threshold                      |          | Percentage of output voltage                         |      | 85    |       | %     |
| $I_{OUT}$ OCP                               |          | DC Current Value                                     | 60   |       | 70    | A     |
| OTP threshold                               |          |  |      | 120   |       | °C    |
| OTP hysteresis                              |          |  |      | 102   |       | °C    |
| POK threshold                               |          | On level   |      | 95    |       | %     |
| POK threshold                               |          | Off level  |      | 90    |       | %     |

Note 1: For 5V regulator design, allocate 150mA

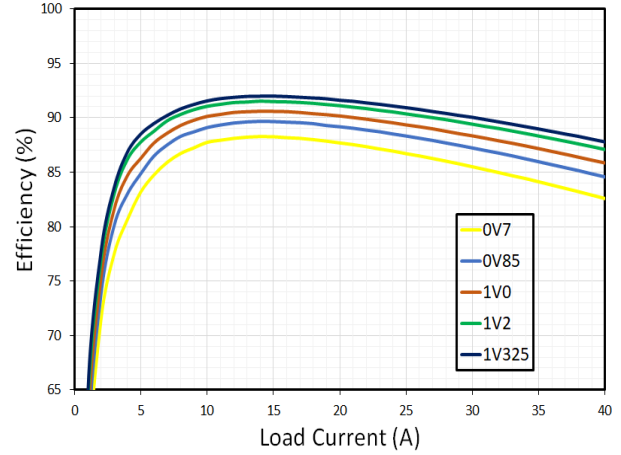
## Typical Performance Characteristics

All the performance curves are measured with EM2040 evaluation board at 25°C ambient temperature unless otherwise noted. The output capacitors configuration for the evaluation board is 2 x 470 μF (3 mΩ ESR) + 4 x 100 μF (Ceramic) + 4 x 47 μF (Ceramic).

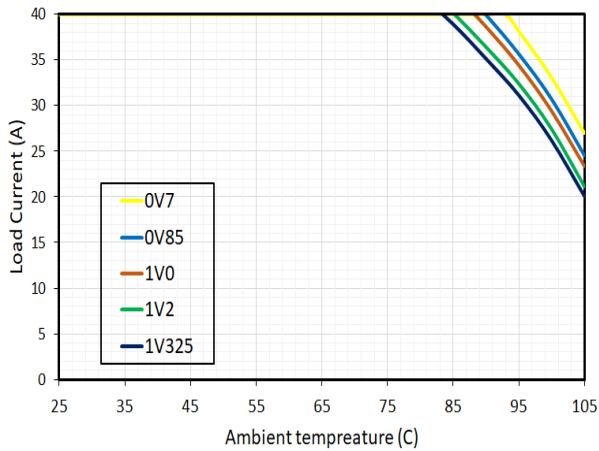
Efficiency,  $V_{IN} = 12V$



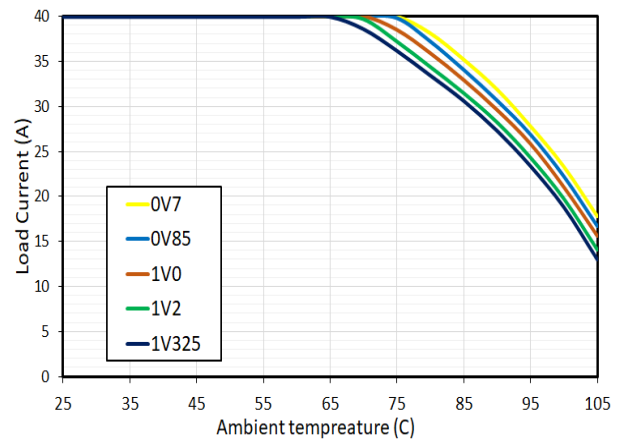
Efficiency,  $V_{IN} = 5V$



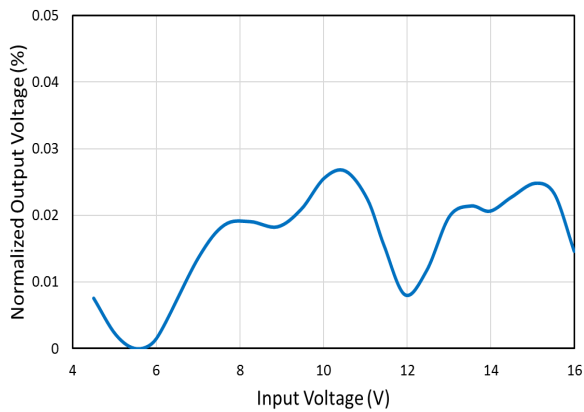
Thermal Derating, With Airflow 400 LFM



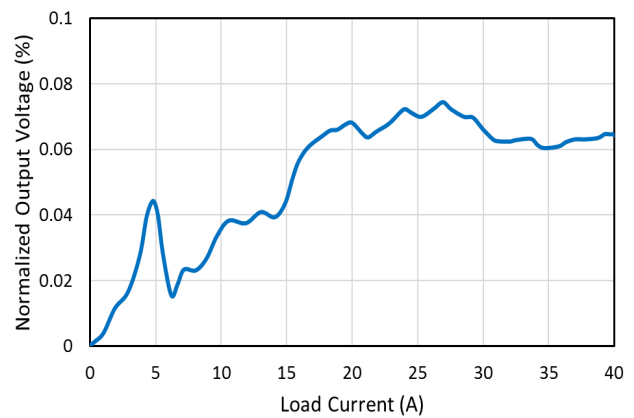
Thermal Derating, No Airflow



EM2040 Line Regulation,  $V_{OUT} = 0.9V$

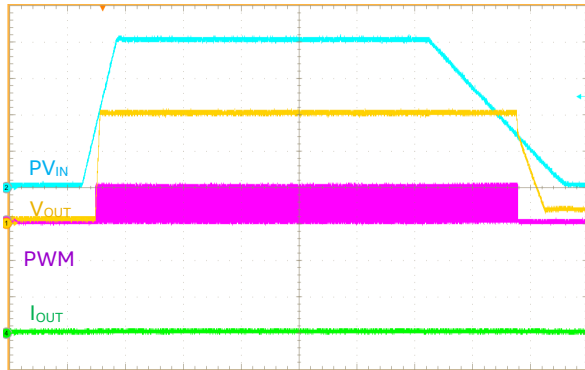


EM2040 Load Regulation,  $V_{OUT} = 0.9V$



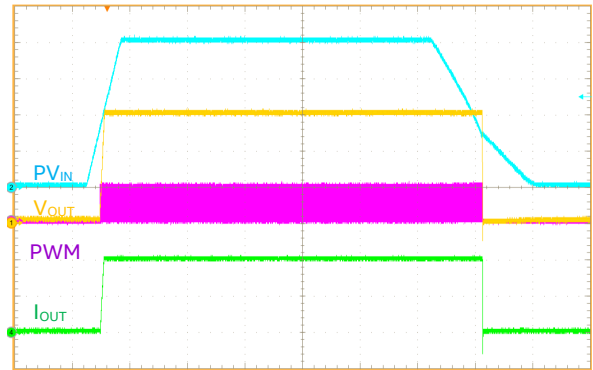
## Typical Performance Characteristics (Continued)

Start-up/Shutdown, PVIN At No Load,  
20 ms/div



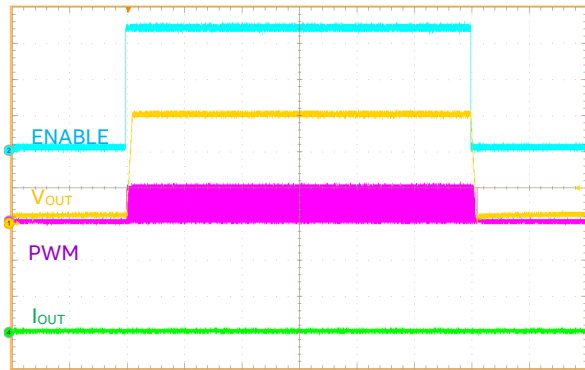
PV<sub>IN</sub> and PWM: 3 V/div,  
V<sub>OUT</sub>: 300 mV/div, I<sub>OUT</sub>: 20 A/div

Start-up/Shutdown, PVIN At 20A Load,  
20 ms/div



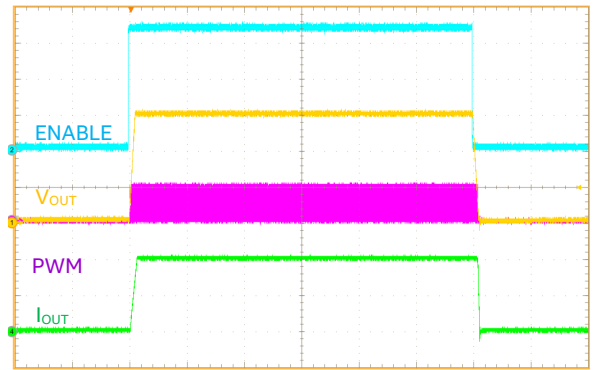
PV<sub>IN</sub> and PWM: 3 V/div,  
V<sub>OUT</sub>: 300 mV/div, I<sub>OUT</sub>: 20 A/div

Start-up/Shutdown, ENABLE At No Load,  
10 ms/div



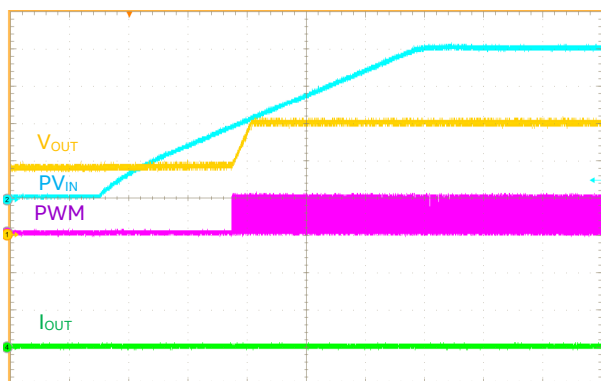
ENABLE: 1 V/div, PWM: 3 V/div,  
V<sub>OUT</sub>: 300 mV/div, I<sub>OUT</sub>: 20 A/div

Start-up/Shutdown, ENABLE At 20A Load,  
10 ms/div



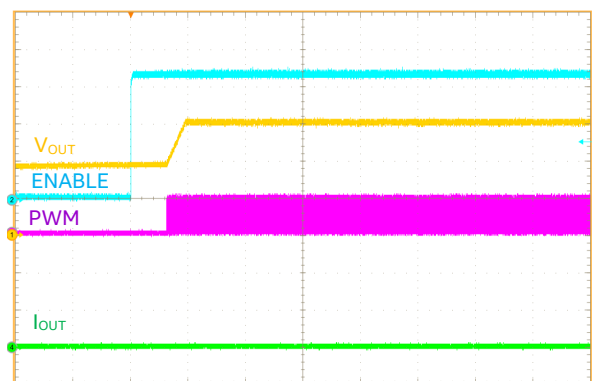
ENABLE: 1 V/div, PWM: 3 V/div,  
V<sub>OUT</sub>: 300 mV/div, I<sub>OUT</sub>: 20 A/div

Start-up Into 0.6V Pre-Bias With PVIN,  
2 ms/div



PV<sub>IN</sub>: 3 V/div, PWM: 3 V/div,  
V<sub>OUT</sub>: 300 mV/div, I<sub>OUT</sub>: 20 A/div

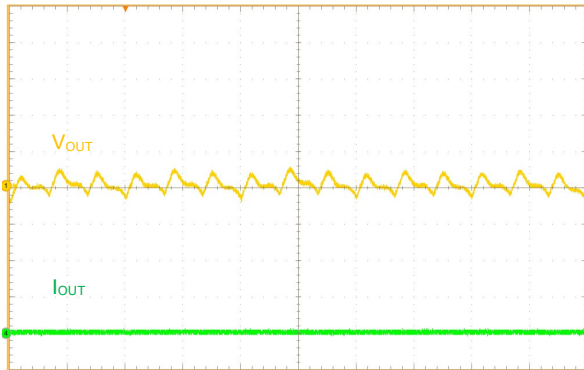
Start-up Into 0.6V Pre-Bias With ENABLE,  
2 ms/div



ENABLE: 1 V/div, PWM: 3 V/div,  
V<sub>OUT</sub>: 300 mV/div, I<sub>OUT</sub>: 20 A/div

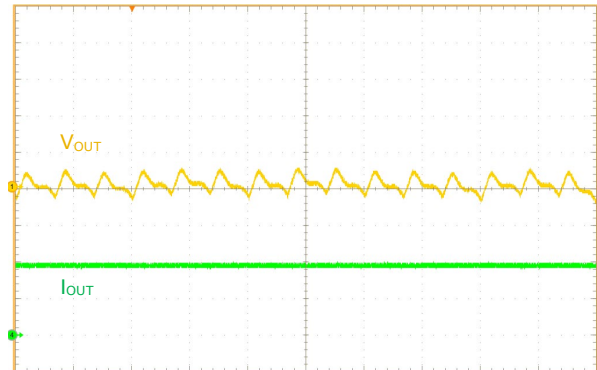
## Typical Performance Characteristics (Continued)

### Output Voltage Ripple, No Load



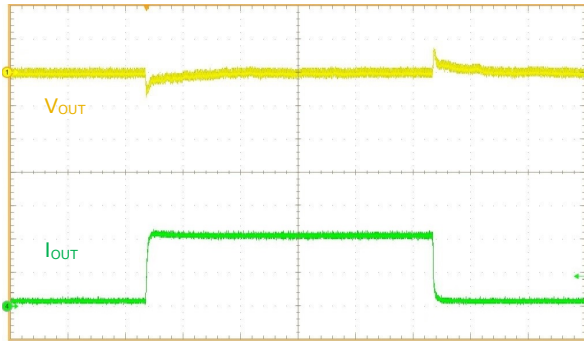
$V_{IN} = 12V, V_{OUT} = 0.9V$   
 $2 \mu s/div, V_{OUT}: 10 mV/div, 20 MHz bandwidth$

### Output Voltage Ripple, 40A Load



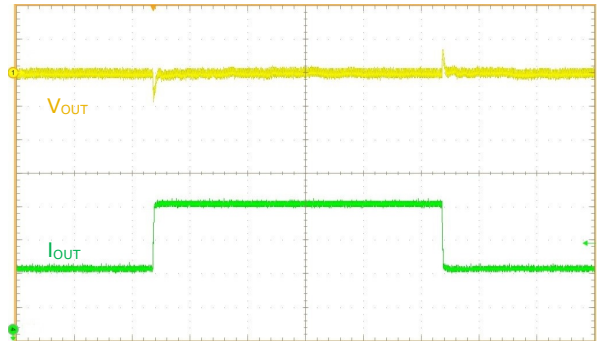
$V_{IN} = 12V, V_{OUT} = 0.9V$   
 $2 \mu s/div, V_{OUT}: 10 mV/div, 20 MHz bandwidth$

### Output Voltage Transient Response, Load Step From 0A To 20A



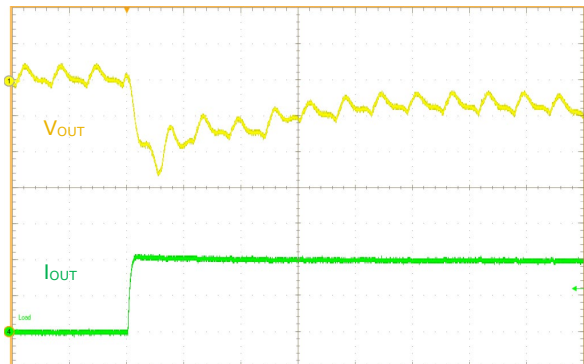
$V_{IN} = 12V, V_{OUT} = 0.9V, 100 \mu s/div$   
 $V_{OUT}: 30mV/div, I_{OUT}: 10A/div, 10A/\mu s$

### Output Voltage Transient Response, Load Step From 20A To 40A



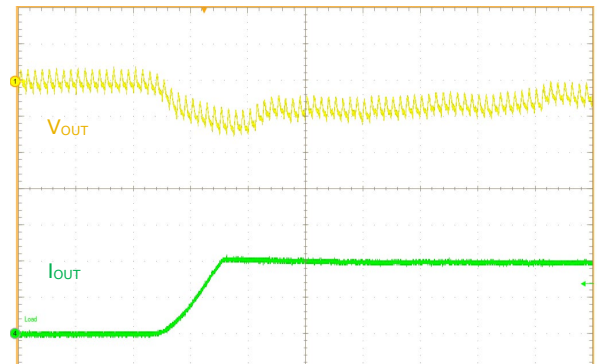
$V_{IN} = 12V, V_{OUT} = 0.9V, 100 \mu s/div$   
 $V_{OUT}: 30mV/div, I_{OUT}: 10A/div, 10A/\mu s$

### Output Voltage Transient Response, Load Step From 0A To 20A



$V_{IN} = 12V, V_{OUT} = 0.9V, 2 \mu s/div$   
 $V_{OUT}: 10mV/div, I_{OUT}: 10A/div, 10A/\mu s$

### Output Voltage Transient Response, Load Step From 0A To 20A



$V_{IN} = 12V, V_{OUT} = 0.9V, 10 \mu s/div$   
 $V_{OUT}: 10 mV/div, I_{OUT}: 10A/div, 1A/\mu s$

## Functional Block Diagram

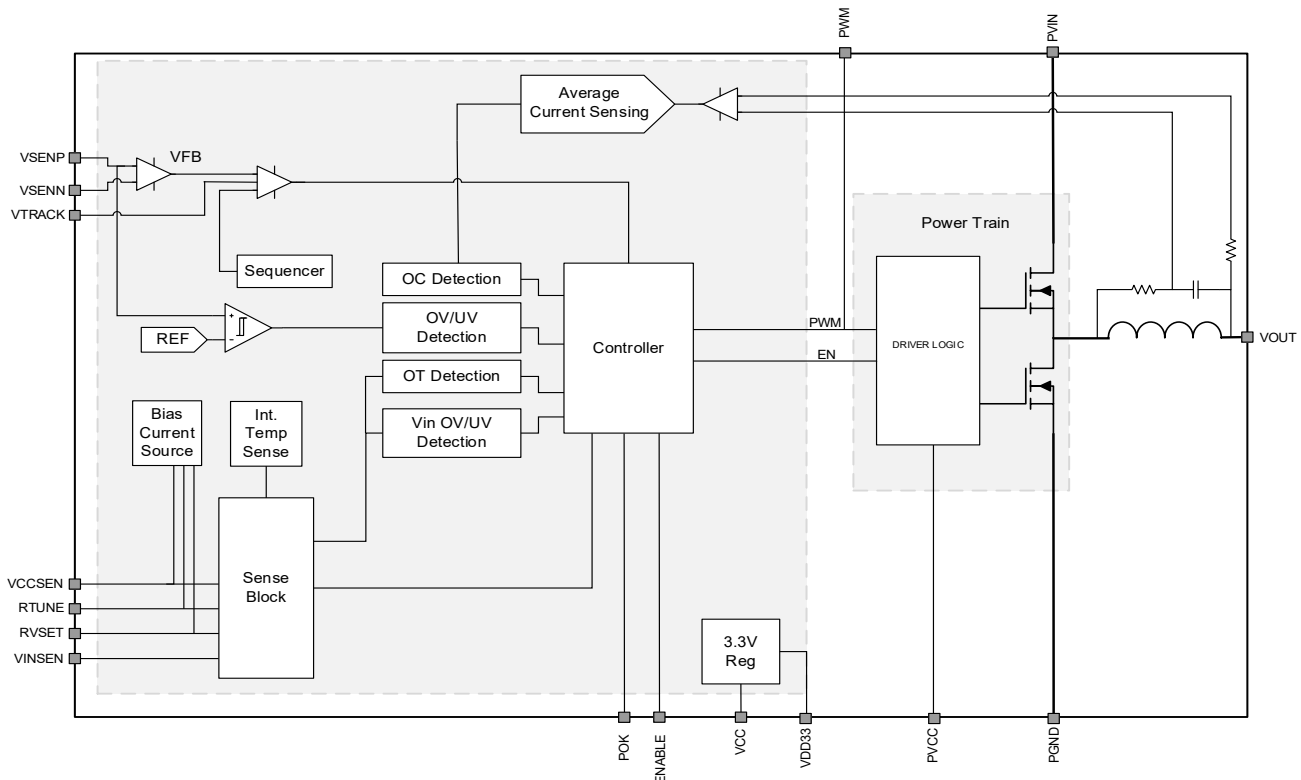


Figure 2: Functional Block Diagram

## Functional Description

### FUNCTIONAL DESCRIPTION

The EM2040 is a single output PowerSoC synchronous step-down converter capable of supplying up to 40A of continuous output current. The PowerSoC includes integrated power MOSFETs, a high-performance inductor and a digital controller.

The EM2040 requires only two resistors to set the output voltage and set the compensation. This easy-to-use set-up allows the user to tune the EM2040 to meet the most demanding accuracy and load transient requirements. The device switches at 800KHz, and is optimized for both efficiency and transient performance and uses a voltage-mode controller.

The EM2040 controller features two PID compensators for steady-state operation and fast transient operation. Fast, reliable switching between the different compensation modes ensures good transient performance and quiet steady state performance. The EM2040 has been designed with a selection of compensators which lets the user select the most suitable one thereby giving the best transient response and stability for the output capacitance of the system. The compensator is chosen using the RTUNE resistor.

The EM2040 offers a complete suite of fault warnings and protections. Input and output Under Voltage Lock-Out (UVLO) and Over Voltage Lock-Out (OVLO) conditions are continuously monitored along with fast Over-

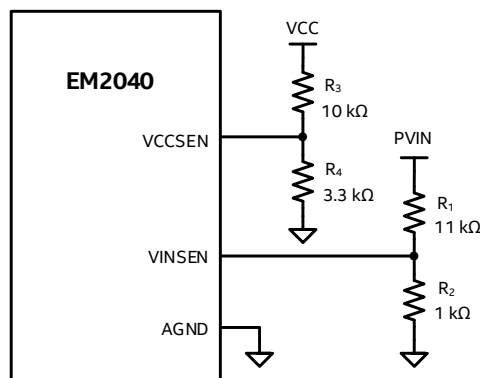
Current Protection (OCP). Over Temperature Protection (OTP) is accomplished by direct monitoring of the device's internal temperature.

## POWER ON RESET

The EM2040 employs an internal power-on-reset (POR) circuit to ensure proper start-up and shut down with a changing supply voltage. Once the VCC supply voltage increases above the POR threshold voltage, the EM2040 begins the internal start-up process. Upon its completion, the device is ready for operation.

Two separate input voltage supplies are necessary to operate, PVIN (4.5V to 16V) and V<sub>CC</sub> (4.75V to 5.25V). Both of these voltage rails are monitored for proper power-up and to protect the power MOSFETs under various input power fault conditions. A voltage divider on each input voltage supply connected to V<sub>INSEN</sub> for the power rail (PVIN) and V<sub>CCSEN</sub> for the supply rail (VC) is used for monitoring of both rails.

As illustrated in Figure 3, the values of resistors R1, R2, R3 and R4 are chosen so the internal monitoring circuitry is within the appropriate ranges. It is mandatory that the listed resistors values are used to ensure proper operation with the EM2040. The resistors used must be R1=11 kΩ, R2=1 kΩ, R3=10 kΩ and R4=3.3 kΩ, using 1% tolerance or better resistors.



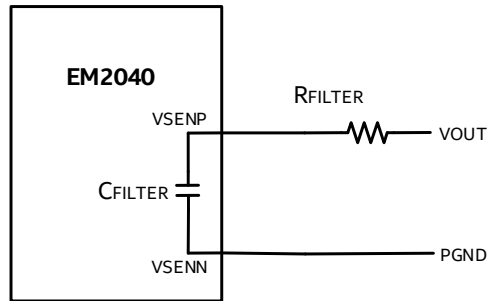
**Figure 3: V<sub>INSEN</sub> And V<sub>CCSEN</sub> Input Resistor Dividers**

The EM2040 also uses the PVIN monitor for input voltage feed-forward, which eliminates variations in the output voltage due to sudden changes in the input voltage supply. It does this by immediately changing the duty cycle to compensate for the input supply variation by normalizing the DC gain of the loop.

## SETTING THE OUTPUT VOLTAGE

Differential remote sensing provides for precise regulation at the point of load. One of thirty output voltages may be selected, based on a resistor connected to the RVSET pin. At power-up, an internal current source biases the resistor and the voltage is measured to make the V<sub>out</sub> selection. Use the RVSET tables (

Table 8) for the details of V<sub>OUT</sub> selection and RVSET values



**Figure 4: Output Voltage Sense Circuitry**

The EM2040 supports direct output voltage feedback connection over the entire  $V_{OUT}$  range. The resistor  $R_{DIV2}$  may be used to adjust  $V_{OUT}$  slightly or to get a  $V_{OUT}$  value not supported by  $R_{VSET}$ . Resistors with tight tolerances are recommended to maintain output voltage accuracy.

The resistor  $R_{FILTER}$  in the feedback path forms a low-pass filter with the internal capacitor,  $C_{FILTER}$ , to help remove any high-frequency disturbances from the sense signals. Place the resistor  $R_{FILTER}$  as close as possible to the EM2040 for best filtering performance.

**Table 7: Output Voltage Feedback Component**

| Module | $V_{OUT}$                       | $R_{FILTER}$ |
|--------|---------------------------------|--------------|
| EM2040 | $0.7V \leq V_{OUT} \leq 1.325V$ | 2 k $\Omega$ |

**Table 8: Supported Configuration Voltage Values For EM2040 Output Voltage**

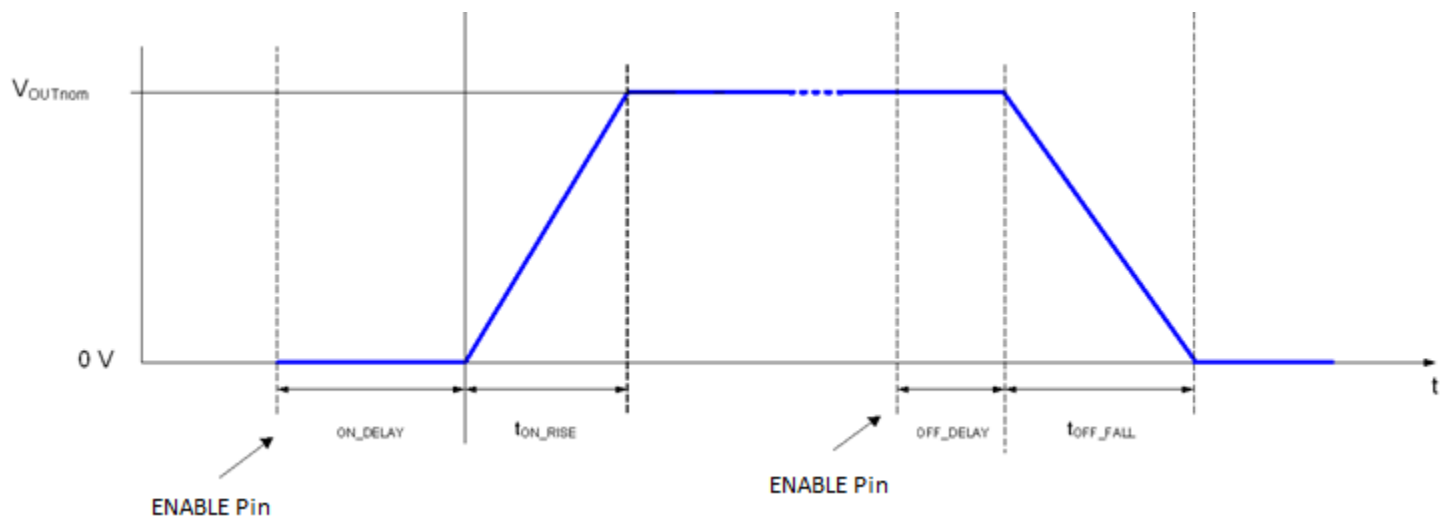
| $R_{VSET}$ Resistor | $V_{OUT}$ |
|---------------------|-----------|
| 0k $\Omega$         | 0.5V      |
| 0.392k $\Omega$     | 0.55V     |
| 0.576k $\Omega$     | Reserved  |
| 0.787k $\Omega$     | Reserved  |
| 1.000k $\Omega$     | 1.325V    |
| 1.240k $\Omega$     | 1.3V      |
| 1.500k $\Omega$     | 1.275V    |
| 1.780k $\Omega$     | 1.25V     |
| 2.100k $\Omega$     | 1.225V    |
| 2.430k $\Omega$     | 1.2V      |
| 2.800k $\Omega$     | 1.175V    |
| 3.240k $\Omega$     | 1.15V     |
| 3.740k $\Omega$     | 1.12V     |
| 4.220k $\Omega$     | 1.1V      |
| 4.750k $\Omega$     | 1.075V    |

| RVSET Resistor | V <sub>OUT</sub> |
|----------------|------------------|
| 5.360kΩ        | 1.05V            |
| 6.040kΩ        | 1.03V            |
| 6.810kΩ        | 1.0V             |
| 7.680kΩ        | 0.975V           |
| 8.660kΩ        | 0.95V            |
| 9.530kΩ        | 0.925V           |
| 10.500kΩ       | 0.9V             |
| 11.800kΩ       | 0.875V           |
| 13.000kΩ       | 0.85V            |
| 14.300kΩ       | 0.825V           |
| 15.800kΩ       | 0.8V             |
| 17.400kΩ       | 0.775V           |
| 19.100kΩ       | 0.75V            |
| 21.000kΩ       | 0.725V           |
| 23.200kΩ       | 0.7V             |

## ENABLE And OUTPUT START-UP BEHAVIOR

The ENABLE pin provides a means to enable normal operation or to shut down the device. When the ENABLE pin is asserted (high) the device will undergo a normal soft-start. A logic low on this pin will power the device down in a controlled manner. Dedicated pre-biased start-up logic ensures proper start-up of the power converter when the output capacitors are pre-charged to a non-zero output voltage. Closed-loop stability is ensured during this period.

The typical power sequencing, including ramp up/down and delays is shown in [Figure 5](#).



**Figure 5: Power Sequencing**

## POWER OK

The EM2040 has a Power OK (POK) indicator at its output pin, which is Open Drain and therefore requires a pull-up resistor. The Pull-Up resistor may be connected to the VDD33 pin but it is not recommended to use the 5VCC supply. When de-asserted, POK indicates that the output voltage is below a certain threshold value. The POK on threshold is set to 95% of the programmed output voltage. When asserted, POK indicates that the output is in regulation, and no major faults are present. POK de-asserts (90%) during any serious fault condition where power conversion stops and re-asserts when the output voltage recovers.

In a noisy application, it is strongly recommended that a 100nf decoupling capacitor be placed between the POK pin and GND to act as a filter to unwanted external noise .

## COMPENSATING THE CONTROL LOOP

To improve the transient performance for a typical point-of-load design, it is common to add output capacitance to the converter. This moves the output LC resonant frequency lower as capacitance increases which results in lower bandwidth, lower phase margin, and longer settling times unless the control loop is compensated for added capacitance.

However, with EM2040 the user does not need to be concerned with, or even understand, the details of control loop compensation techniques. RTUNE allows users to select from a number of PID control loop settings (known as compensators) through the use of pin-strapping. A single resistor from the RTUNE pin to AGND informs the EM2040 of the compensator selection.

The selection of the compensator is driven first by the type of output capacitors used, as the ESL and ESR of different capacitor types demands different PID coefficients to optimize transient deviation and recovery characteristics. An all ceramic output capacitor design requires a different compensator than a design with a combination of ceramic and polymer capacitors, i.e. POSCAP. [Table 10](#) shows several output capacitor part number recommendations.

The EM2040 supports three different compensators can then be subdivided into groups of six each whereby the initial capacitance value in the appropriate compensator can be scaled upwards by multiplication factor  $M$  to match the additional capacitance.

Table 9 :RTUNE configuration table for EM2040

| Compensator Description   | C <sub>OUT</sub> | RTUNE Resistor | Multiplication factor (M) | Typical Deviation With 20A Load Step |
|---|------------------|----------------|---------------------------|--------------------------------------|
| Polymer Aluminum (SP-CAP) and Ceramic MLCC Output Capacitors<br>Base capacitance = 1 x 470µF (Polymer) + 2 x 100µF (Ceramic) + 2 x 47µF (Ceramic) | Base             | 0kΩ            | 1                         | ± 5%                                 |
|   | 2 x Base         | 0.392kΩ        | 2                         | ± 3%                                 |
|   | 3 x Base         | 0.576kΩ        | 3                         |                                      |
|   | 4 x Base         | 0.787kΩ        | 4                         | ± 1.5%                               |
|   | 5 x Base         | 1.000kΩ        | 5                         |                                      |
|   | 6 x Base         | 1.240kΩ        | 6                         |                                      |
| All MLCC Ceramic Output Capacitors<br>Base capacitance = 8 x 100µF  | Base             | 1.500kΩ        | 1                         | ± 5%                                 |
|   | 1.5 x Base       | 1.780kΩ        | 1.5                       |                                      |
|   | 2 x Base         | 2.100kΩ        | 2                         | ± 3%                                 |
|   | 3 x Base         | 2.430kΩ        | 3                         |                                      |
|   | 4 x Base         | 2.800kΩ        | 4                         |                                      |
|   | 4.5 x Base       | 3.240kΩ        | 4.5                       | ± 1.5%                               |
| POSCAP and Ceramic MLCC Output Capacitors<br>Base capacitance = 4 x 330 µF (POSCAP) + 2 x 100 µF (Ceramic)  | Base             | 3.740kΩ        | 1                         | ± 5%                                 |
|   | 1.5 x Base       | 4.220kΩ        | 1.5                       |                                      |
|   | 2 x Base         | 4.750kΩ        | 2                         | ± 3%                                 |
|   | 2.5 x Base       | 5.360kΩ        | 2.5                       |                                      |
|   | 3 x Base         | 6.040kΩ        | 3                         | ± 1.5%                               |
|   | 3.5 x Base       | 6.810kΩ        | 3.5                       |                                      |

Table 10: Recommended Output Capacitors

| Description                                | Manufacturer | P/N                |
|--|--------------|--------------------|
| 470 $\mu$ F, 2.5V, ESR 3m $\Omega$ SP-CAP  | Panasonic    | EEFGX0E471R        |
| 330 $\mu$ F, 6.3V, ESR 9 m $\Omega$ POSCAP | Panasonic    | 6TPF330M9L         |
| 330 $\mu$ F, 2.5V, ESR 9 m $\Omega$ POSCAP | Kemet        | T520B337M2R5ATE009 |
| 100 $\mu$ F, 6.3V, X5R, 1206 Ceramic       | Kemet        | C1206C107M9PACTU   |
| 47 $\mu$ F, 6.3V, X5R 1206 Ceramic         | Murata       | GRM31CR60J476ME19L |

## OUTPUT CAPACITOR RECOMMENDATION

EM2040 is designed for fast transient response and low output ripple noise. The output capacitors should be low ESR polymer, tantalum or ceramic capacitor. **Table 9** shows different output capacitor combinations to optimize the load transient deviation performance. With the Rtune feature, the user can simply scale up the total output capacitance to meet further stringent transient requirement.

Please consult the documentation for your particular FPGA, ASIC, processor, or memory block for the transient and the bulk decoupling capacitor requirements.

## INPUT CAPACITOR RECOMMENDATION

The EM2040 input should be decoupled with at least three 22 $\mu$ F 1206 case size and one 10 $\mu$ F 0805 case size MLCC ceramic capacitors or four 22 $\mu$ F MLCC 1206 case size ceramic capacitors. More bulk capacitor may be needed only if there are long inductive traces at the input source or there is not enough source capacitance.

These input decoupling ceramic capacitors can be mounted on the PCB back-side to reduce the solution size. These input filter capacitors should have the appropriate voltage rating for the input voltage on PVIN, and use a X5R, X7R, or equivalent dielectric rating. Y5V or equivalent dielectric formulations must not be used as these lose too much capacitance with frequency, temperature and bias voltage.

The PVCC pin provides power to the gate drive of the internal high/low side power MOSFETs. The VCC pin provides power to the internal controller. These two power inputs share the same supply voltage (5V nominal), and should be bypassed with a single 2.2 $\mu$ F MLCC capacitor. To avoid switching noise injection from PVCC to VCC, it is recommended a ferrite bead is inserted between PVCC and VCC pins as shown [Figure 12](#).

## PROTECTION FEATURES

The EM2040 has a complete suite of fault protections. Input and output Under Voltage Lock-Out (UVLO) and Over Voltage Lock-Out (OVLO) conditions are continuously monitored along with the output current to provide fast Over-Current Protection (OCP) response.

To prevent damage to the load, the EM2040 also utilizes an output over-voltage protection circuit. The voltage at VSEN is continuously compared with a RVSET OVP threshold using a high-speed analog comparator. If the voltage exceeds the OVP threshold, a fault response is generated and the PWM output is turned off.

Over Temperature Protection (OTP) is based on direct monitoring of the modules internal temperature. If the temperature exceeds the OTP threshold, the device will enter a soft-stop mode slowly ramping the output voltage down until the temperature falls below the recovery temperature.

The fault response is for the output to latch off for most fault conditions. The ENABLE pin may be cycled to clear the latch. Table 11 summarizes the settings that have been implemented in the device.

**Table 11: Fault Overview**

| Signal               | Fault Level | Response Type  | VOUT                   |
|----------------------|-------------|----------------|------------------------|
| Output Over-Voltage  | Fault       | High-impedance | Latched Off            |
| Output Under-Voltage | Fault       | High-impedance | Latched Off            |
| Input Over-Voltage   | Fault       | High-impedance | Latched Off            |
| Input Under-Voltage  | Fault       | High-impedance | Retry if Fault removed |
| Over-Current         | Fault       | High-impedance | Latched Off            |
| Over-Temperature     | Fault       | Soft Off       | Retry if Fault removed |

The EM2040 monitors various signals during operation in order to detect fault conditions. Measured and filtered signals are compared to a fault threshold which when triggered generates a response as given in table [Table 11](#)

The EM2040 fault response depends on the fault type detected.

The EM2040 responds to an over temperature event by ramping down  $V_{OUT}$  in a controlled manner at a slew rate of approx. 0.18v/ms (Soft Off). For all other faults the EM2040 will respond by immediately turning off both the top-side MOSFET and low-side MOSFET (High-Impedance)

In the event of a Temperature Fault or a Low PVIN Fault the module will restart Vout automatically without user intervention once the fault is deemed to have been removed. For all other faults the module will remain off until the user either toggles the ENABLE pin or recycled the supply whereupon if the fault is removed the VOUT will restart.

## PRE-BIASED START-UP AND SOFT-STOP

In systems with complex power architectures, there may be leakage paths from one supply domain which charge capacitors in another supply domain leading to a pre-biased condition on one or more power supplies. This condition is not ideal and can be avoided through careful design, but is generally not harmful. Attempting

to discharge the pre-bias is not advised as it may force high current through the leakage path. The EM2040 include a feature to allow it to be enabled into pre-biased output capacitors without discharging them.

If the output capacitors are pre-biased when the EM2040 is enabled, start-up logic in the EM2040 ensures that the output does not pull down the pre-biased voltage. Closed-loop stability is ensured during the entire start-up sequence under all pre-bias conditions.

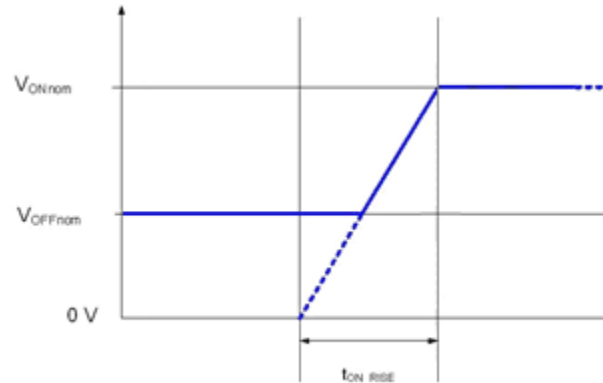


Figure 6: Power Sequencing With Non-Zero Off Voltage

## VOLTAGE TRACKING

The EM2040 can control the output voltage based on the external voltage applied to the VTRACK pin, thus allowing sequencing of the output voltage from an external source. Pre-bias situations are also supported. The VTRACK pin voltage is a single-ended input referenced to analog ground.

If VTRACK is not intended to be used, the VTRACK pin must be tied high. (It cannot be tied low or left floating).

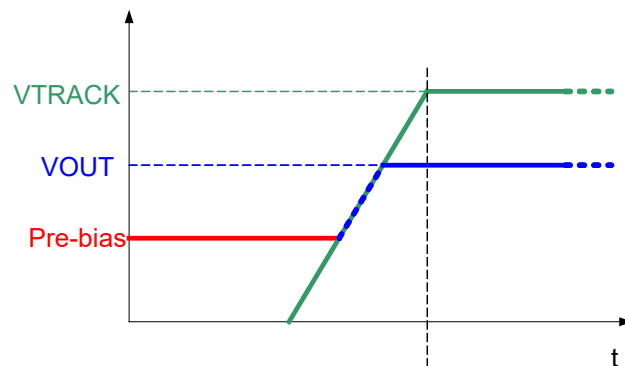
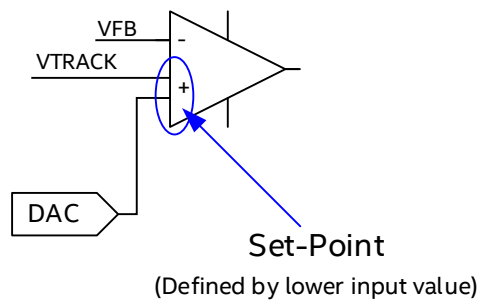


Figure 7: Power Sequencing Using VTRACK With Bias Voltage On VOUT

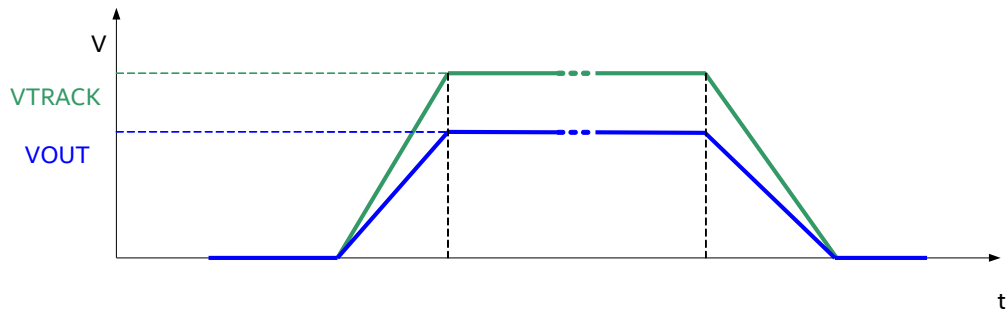
The set point voltage for the EM2040 is defined by the lower value of the  $V_{OUT}$  setting or an external voltage applied to the VTRACK pin. If the VTRACK voltage rises above the  $V_{OUT}$  set point voltage, then the final output voltage will be limited by the  $V_{OUT}$  setting. If the VTRACK pin is tied low or floating, then the output will never start as the VTRACK pin input is always the lower value and will always be in control. Conversely, if VTRACK is tied high, the output will start but will follow the  $V_{OUT}$  set point, not the VTRACK pin.

In the event of using VTRACK for sequencing, it is highly recommended that the VTRACK signal is kept greater than the  $V_{OUT}$  voltage. This ensures that the internal  $V_{OUT}$  set point is used as the final steady-state output voltage and accuracy is not a function of the externally applied VTRACK voltage.

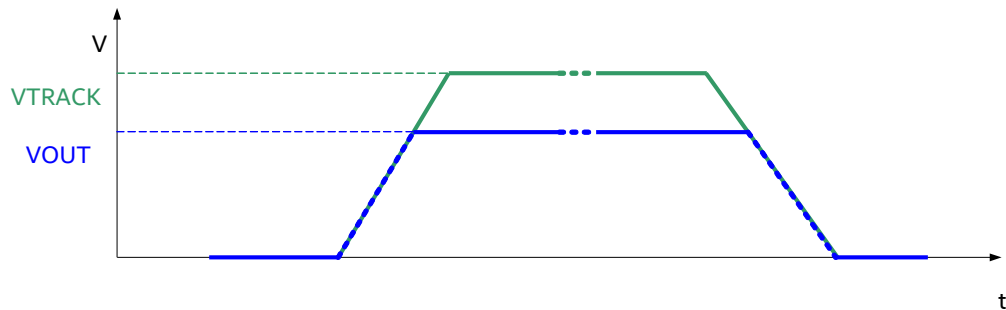


**Figure 8: VTRACK Circuitry**

The following figures demonstrate ratio-metric and simultaneous sequencing of the output voltage, which can be accomplished by applying an appropriate external voltage on the VTRACK pin.



**Figure 9: Ratiometric Sequencing Using VTRACK**



**Figure 13: Simultaneous Sequencing Using VTRACK**

When using the VTRACK feature, the sequencing will be ratio-metric as shown in [Figure 9](#) if an external resistor network is used at the VTRACK pin as shown [Figure 10](#). If no external resistors are used, the output sequence is simultaneous as shown in [Figure 13](#).

In the event that a feedback divider is not required, but the tracking voltage applied to VTRACK is greater than 1.4V, then a 2kΩ resistor is required in series with the VTRACK pin to minimize leakage current as shown in [Figure 11](#).

In applications where a voltage divider is required on the output voltage, a voltage divider consisting of the same values is also required for the VTRACK pin.

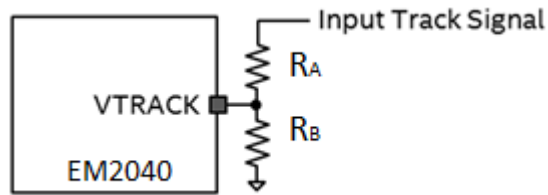


Figure 10: VTRACK Sense Circuitry with Resistor Divider

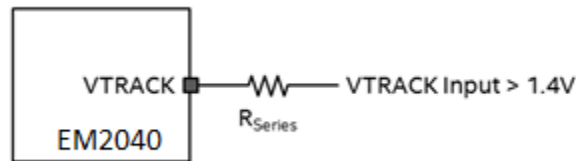


Figure 11: VTRACK Sense Circuitry (Input > 1.4V)

## TEMPERATURE AND OUTPUT CURRENT MEASUREMENT

The EM2040 temperature sense block provides the device with precision temperature information over a wide range of temperatures (-40°C to +150°C). The temperature sense block measures the controller temperature, which will be slightly lower than the powertrain junction temperature.

The EM2040 monitors output current by real-time, temperature compensated DCR current sensing across the inductor. This real-time current waveform is then filtered and averaged for accurate fault warning and management.

Factory calibration has been performed for every EM2040 device to improve measurement accuracy over the full output current range. This allows the EM2040 to correct for DCR manufacturing variations.

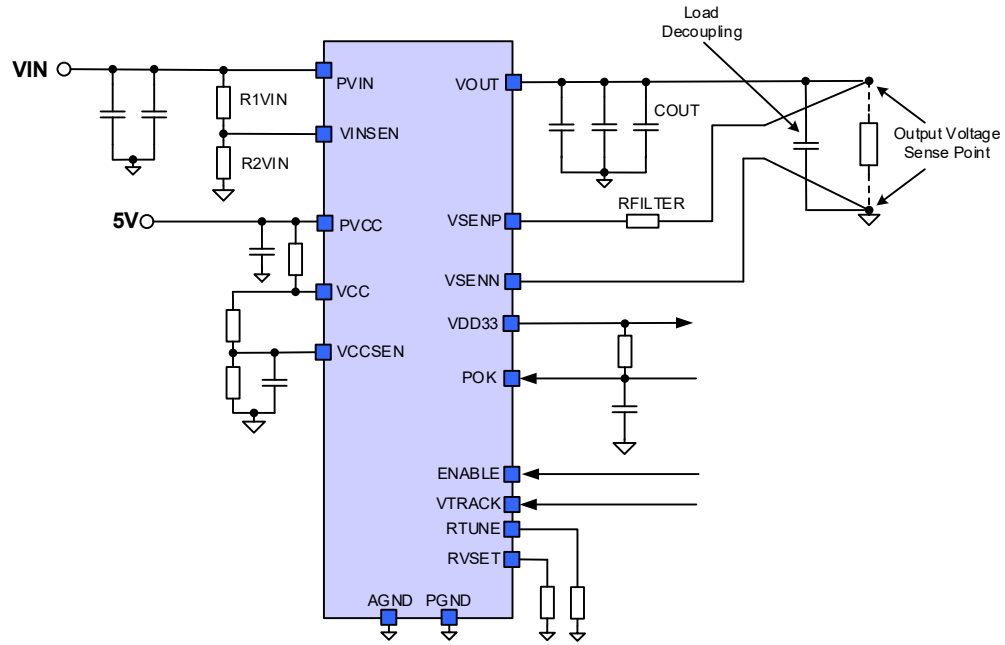
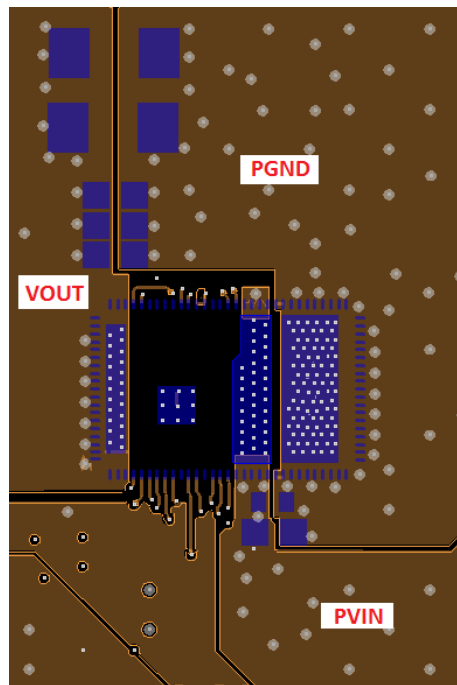


Figure 12: Recommended Application Circuit

## Layout Recommendations

**Recommendation 1:** It is highly recommended to use separate nets for AGND and PGND and connecting them through a 0Ω resistor or a short. This method helps with ground management and prevents the noise from the Power Ground disturbing the more sensitive Analog (“Signal”) Ground.

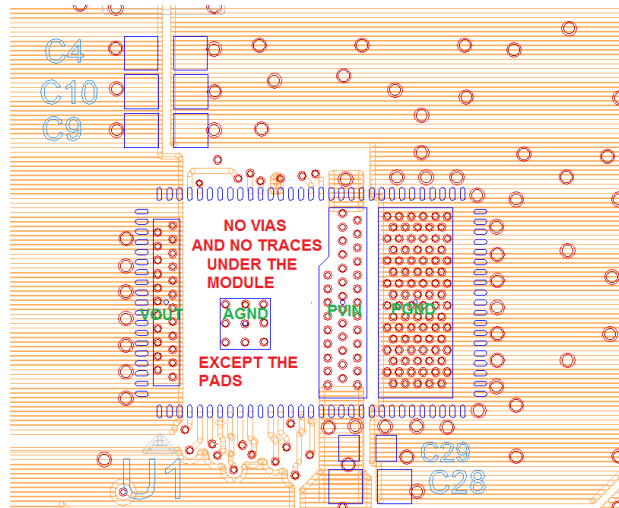
**Recommendation 2:** It is good practice to minimize the PGND loop. Whenever possible the input and output loops should close to the same point, which is the ground of the EM2040 module. Module decoupling ceramic capacitors are to be placed as close as possible to the module in order to contain the switching noise in the smallest possible loops and to improve PVIN decoupling by minimizing the series parasitic inductance of the PVIN traces. For achieving this goal, it helps to place decoupling capacitors on the same side as the module since VIAs are generally more inductive, thus reducing the effectiveness of the decoupling. Of course, bulk and load high frequency decoupling should be placed closer to the load. If the input decoupling is placed on the back side, it is recommended to place small, low value capacitors on the topside right next to the EM2040, to help minimize the effect of via inductance.



**Figure 13: Top Layer Layout With Critical Components Only**

**Recommendation 3:** It is good practice to place the other small components needed by the EM2040 on the opposite side of the board, in order to avoid cutting the power planes on the module side. Since the EM2040 heat is evacuated mostly through the PCB, this will also help with heat dissipation; wide copper planes under the module can also help with cooling. The PVIN copper plane should not be neglected as it helps spread the heat from the high side FET.

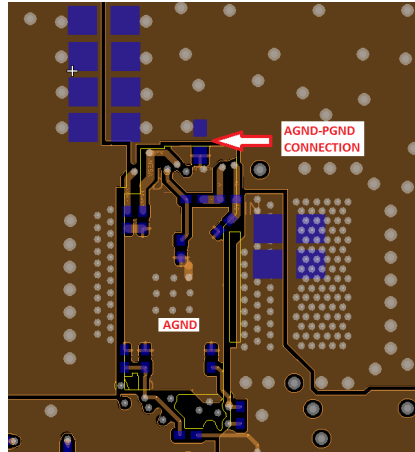
**Recommendation 4:** It is recommended that at least below the EM2040 module, the next layers to the surface (2 and n-1) be solid ground planes, which provides shielding and lower the ground impedance at the module level. AGND should be also routed as a copper plane, in order to reduce the ground impedance and reduce noise injection.



**Figure 14: VIAs in The Power Pads**

**Recommendation 5:** In order to better spread the current and the heat through the inner layers, arrays of VIAs should be placed in the power pads. 10mils diameter is a good size for the plated in-pad VIAs. It is critical that through VIAs should not be placed by any means elsewhere under the module; the non-pad area around AGND is VIA keep out area.

**Recommendation 6:** All other signal and LDO decoupling capacitors should be placed as close as possible to the terminal they are decoupling, while the AGND connection should be done through VIAs to the AGND plane.

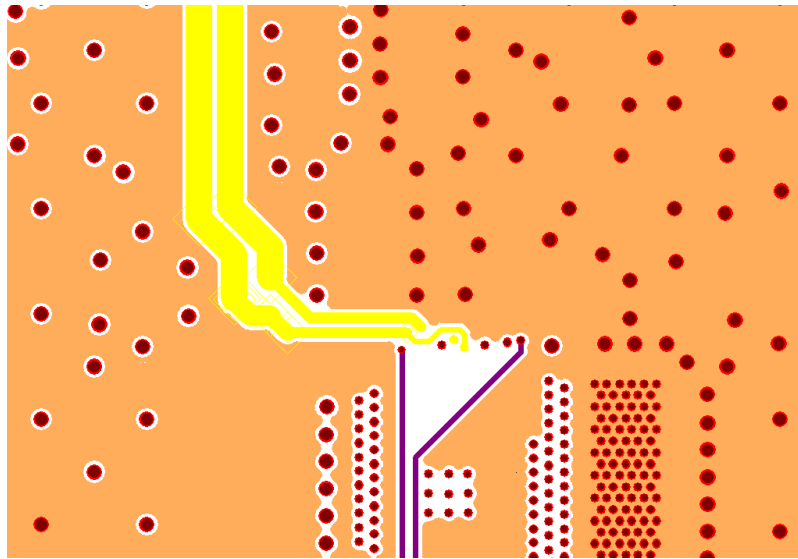


**Figure 15: Backside Decoupling**

**All Signal Decoupling Go To The Bottom AGND Plane And Get Connected To The EM2040 Module AGND Through The AGND In-PAD VIAs (Again, No Other VIAs Are Allowed In That Area)**

**Recommendation 7:** Figure 15 also shows the 0Ω resistor that connects AGND to PGND. The recommended connecting point, as shown, is to a quiet PGND → the output capacitors PGND.

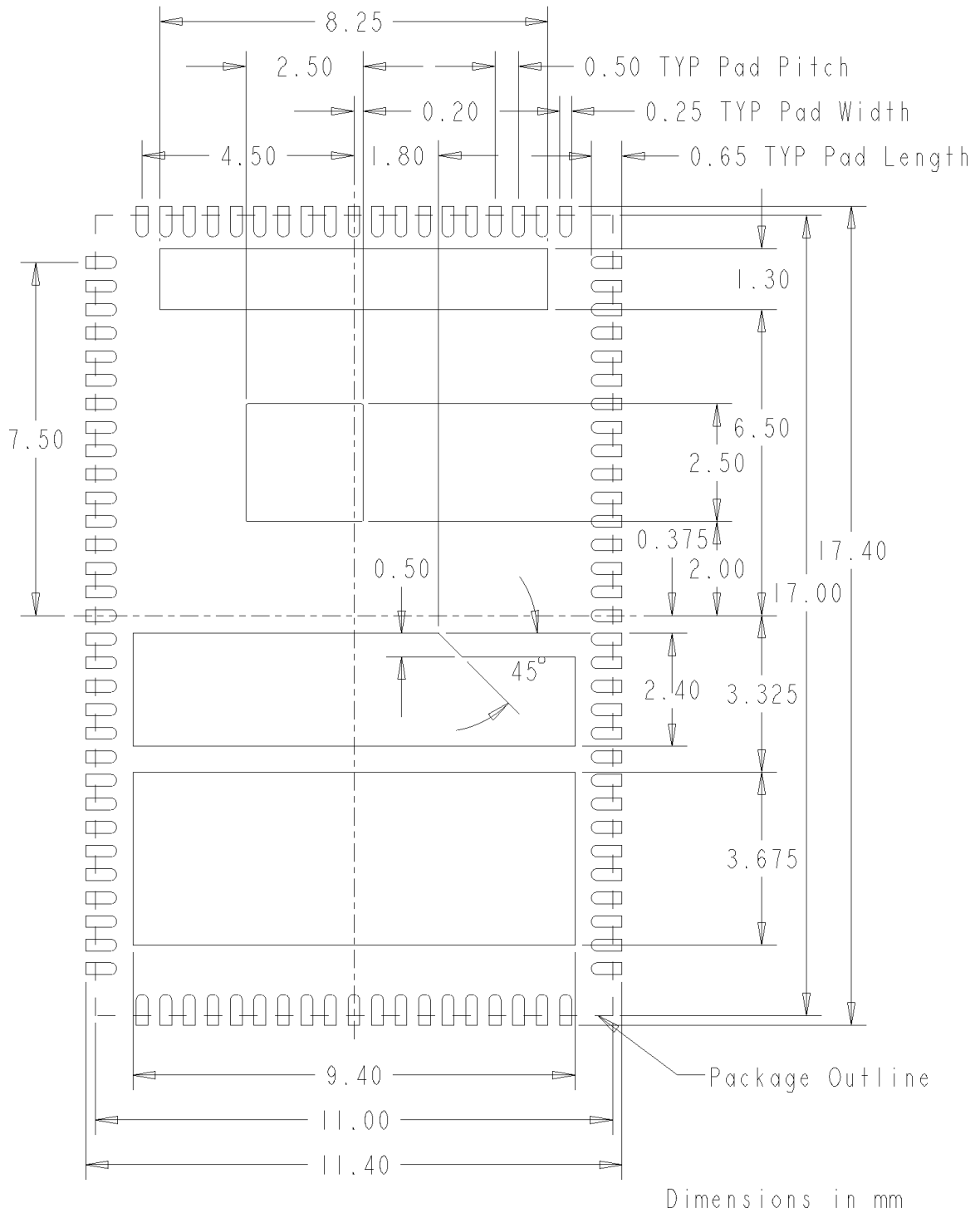
**Recommendation 8:** Differential remote sense should be routed as much as possible as a differential pair, on an inner layer, preferably shielded by a ground plane.



**Figure 16: Remote Sense Routing On An Inner Layer (Highlighted, Yellow)**

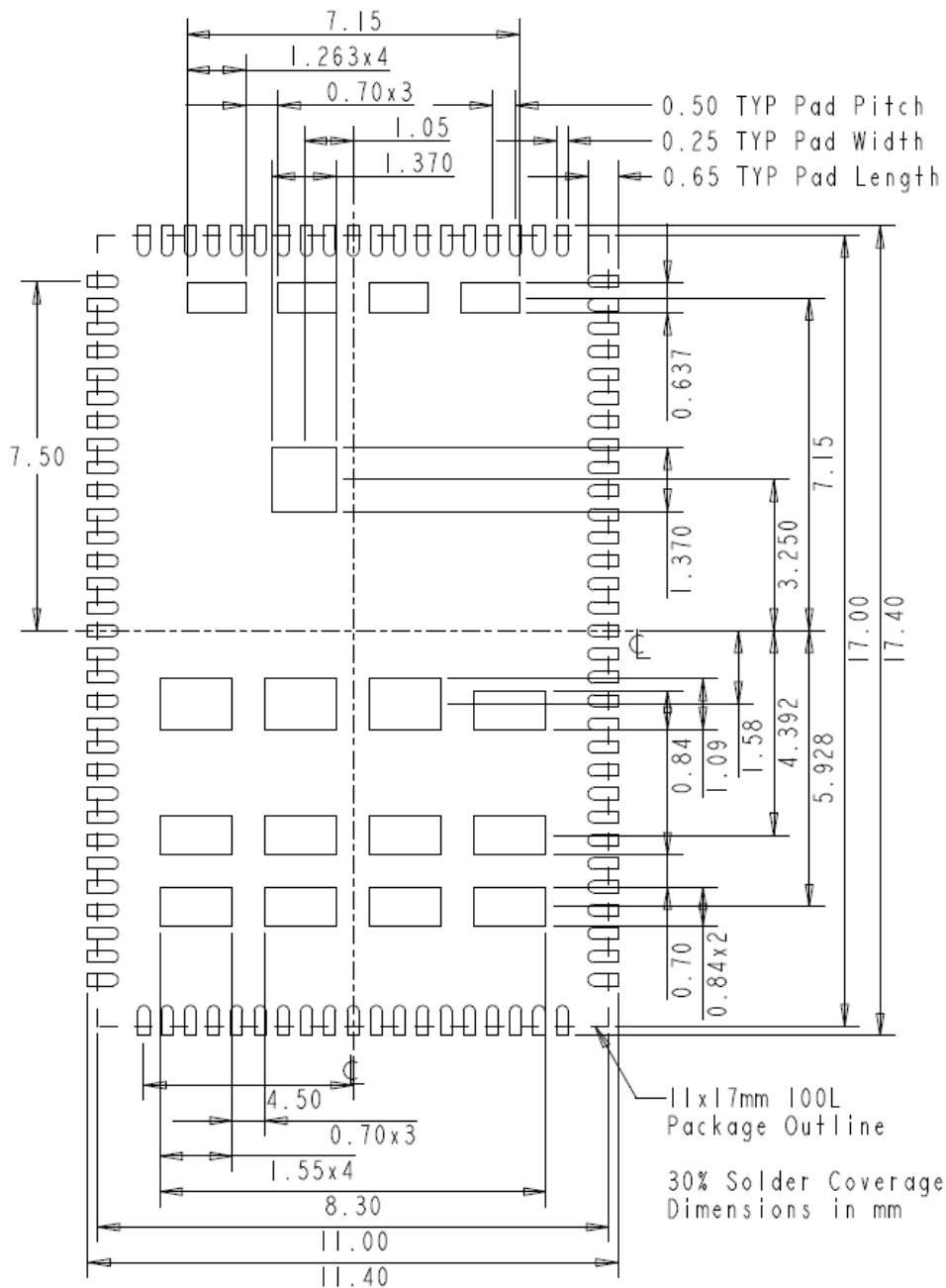
**Recommendation 9:** If the design allows it, stitching VIAs can be used on the power planes, close to the module in order to help with cooling. This is a thermal consideration and does not matter much for the electrical design.

## Recommended PCB Footprint



**Figure 17: Recommended PCB Footprint**

**30% Solder Stencil Aperture (see note below)**

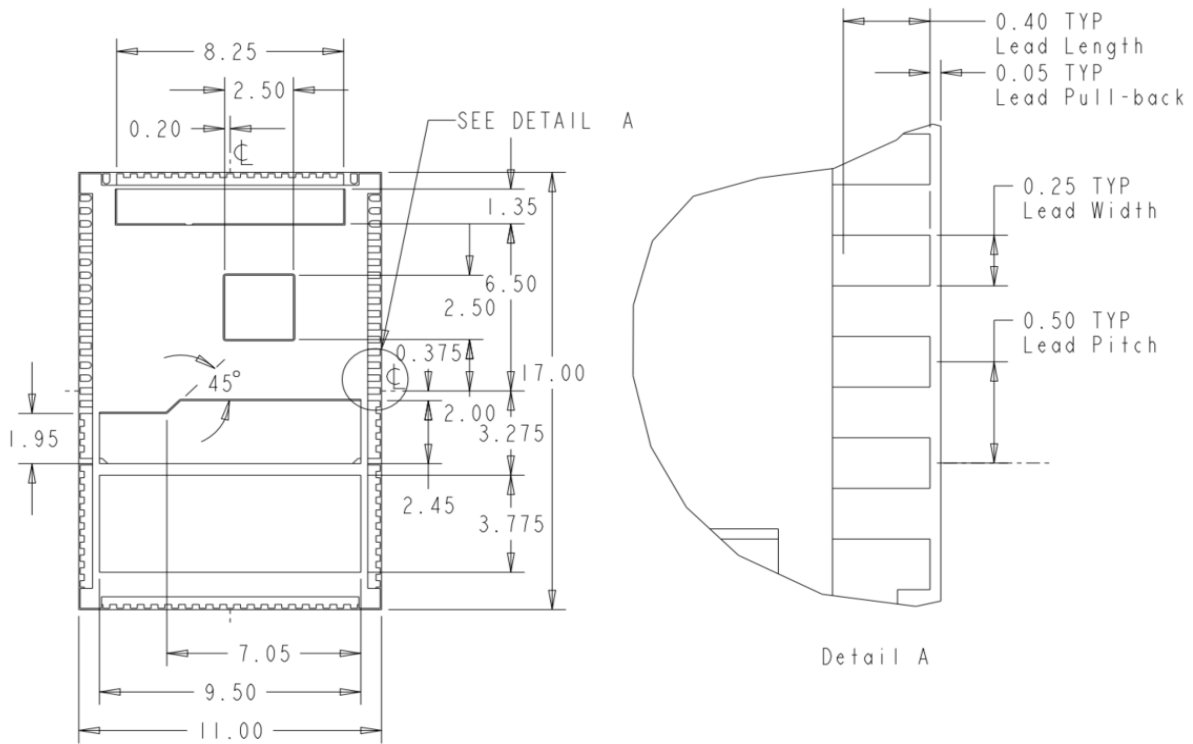


**Figure 18: 30% Solder Stencil Aperture Dimensions**

**Notes:**

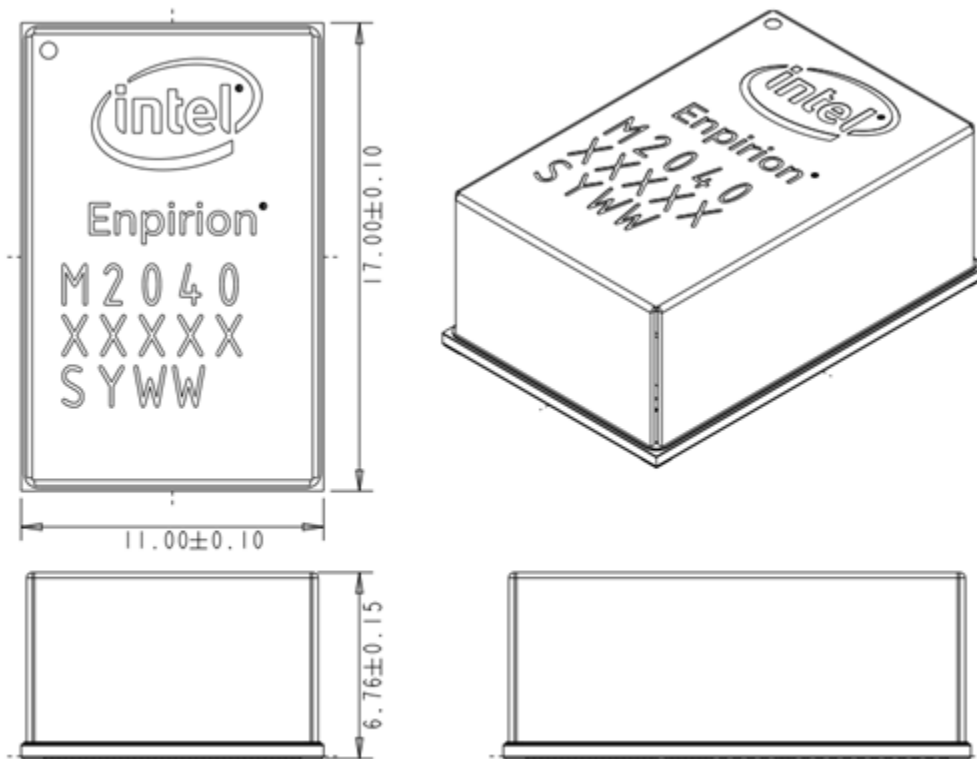
- The solder stencil for each pad under the device is recommended to be up to 30% of the total pad size.
- The aperture dimensions are based on a 4mil stencil thickness

## Package Dimensions



Detail A

Dimensions in mm



Dimensions in mm

Figure 20: Package Dimensions



# Tray Information (Continued)

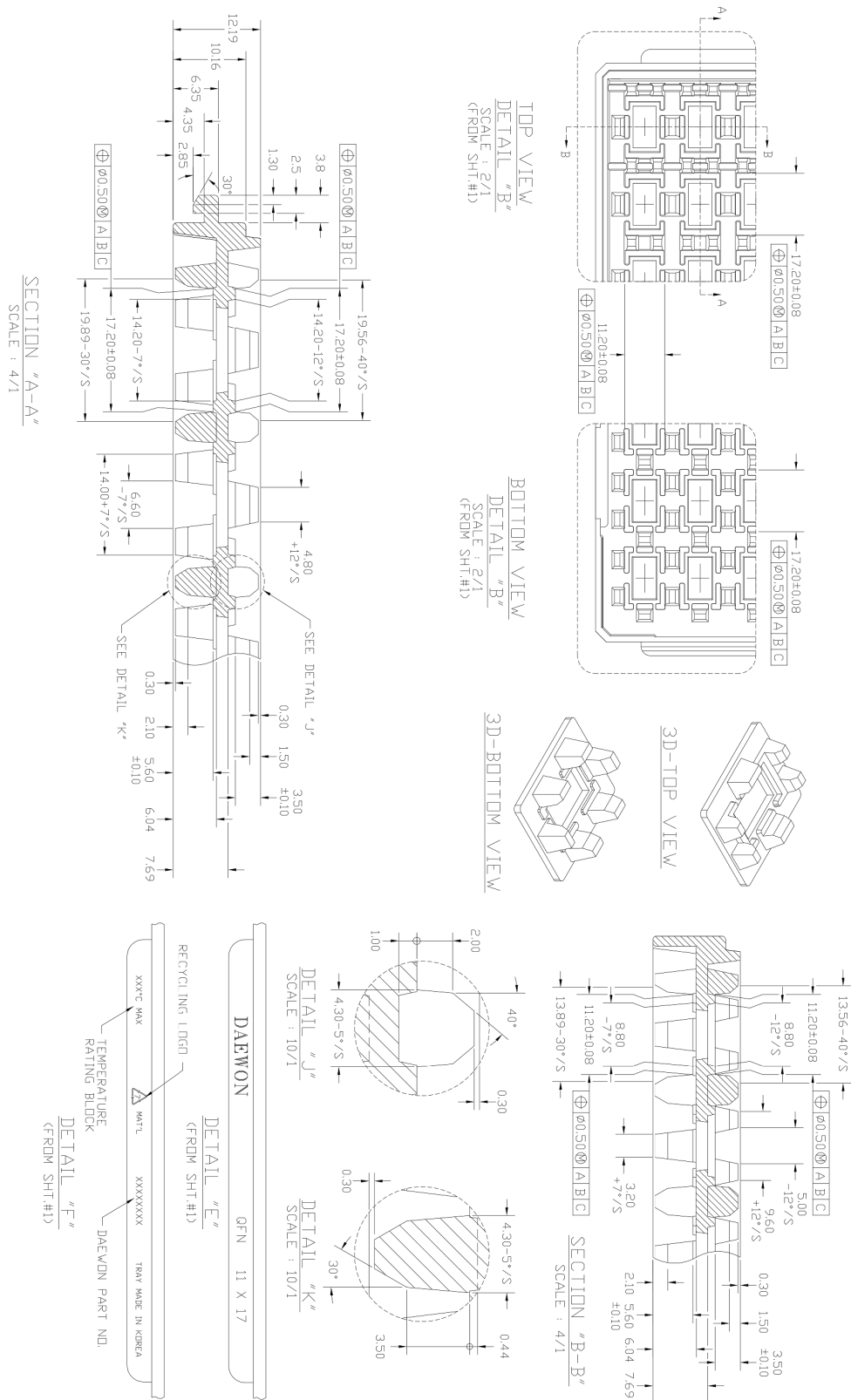


Figure 22: Tray Information 2/2

## Revision History

| Rev | Date    | Change(s)                              |
|-----|---------|--|
| A   | July-18 | Initial Release                        |
| B   | Mar-20  | Removed stencil option for 45% opening |



## Where to Get More Information

For more information about Intel and Intel Enpirion PowerSoCs, visit <https://www.altera.com/enpirion>







© 2016 Intel Corporation. All rights reserved. Intel, the Intel logo, Altera, ARRIA, CYCLONE, ENPIRION, MAX, MEGACORE, NIOS, QUARTUS, and STRATIX words and logos are trademarks of Intel Corporation or its subsidiaries in the U.S. and/or other countries. Other marks and brands may be claimed as the property of others. Intel reserves the right to make changes to any products and services at any time without notice. Intel assumes no responsibility or liability arising out of the application or use of any information, product, or service described herein except as expressly agreed to in writing by Intel. Intel customers are advised to obtain the latest version of device specifications before relying on any published information and before placing orders for products or services.  
\* Other marks and brands may be claimed as the property of others.

## Looking for pricing, stock, or lifecycle information?

Click below to explore more details on WIN SOURCE:

-  [View EM2040N01QI on WIN SOURCE](#)
-  [Intel Information](#)

## Optimize Your Supply Chain with WIN SOURCE Solutions

-  Global Sourcing Solution
-  Obsolete Management
-  Cost Control Management
-  Shortage Management
-  Alternative Solution
-  Excess Inventory Management