



**THE DATASHEET OF
HMC8411LP2FE**



Low Noise Amplifier, 0.01 GHz to 10 GHz

FEATURES

- ▶ Low noise figure: 1.7 dB typical
- ▶ Single positive supply (self biased)
- ▶ High gain: 15.5 dB typical
- ▶ High OIP3: 34 dBm typical
- ▶ 6-lead, 2 mm × 2 mm LFCSP

APPLICATIONS

- ▶ Test instrumentation
- ▶ Military communications

GENERAL DESCRIPTION

The HMC8411LP2FE is a gallium arsenide (GaAs), monolithic microwave integrated circuit (MMIC), pseudomorphic high electron mobility transistor (pHEMT), low noise wideband amplifier that operates from 0.01 GHz to 10 GHz.

The HMC8411LP2FE provides a typical gain of 15.5 dB, a 1.7 dB typical noise figure, and a typical output third-order intercept (OIP3) of 34 dBm, requiring only 55 mA from a 5 V supply voltage. The saturated output power (P_{SAT}) of 19.5 dBm typical enables the low noise amplifier (LNA) to function as a local oscillator (LO) driver for many of Analog Devices, Inc., balanced, in-phase/quadrature (I/Q), or image rejection mixers.

FUNCTIONAL BLOCK DIAGRAM

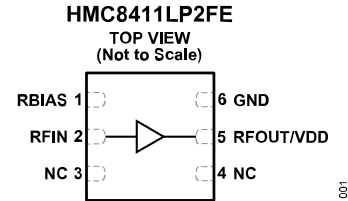

Figure 1.

The HMC8411LP2FE also features inputs and outputs that are internally matched to 50 Ω, making the device ideal for surface-mounted technology (SMT)-based, high capacity microwave radio applications.

The HMC8411LP2FE is housed in a RoHS-compliant, 2 mm × 2 mm, 6-lead LFCSP.

Multifunction pin names may be referenced by their relevant function only.

TABLE OF CONTENTS

Features.....	1	Pin Configuration and Function Descriptions.....	6
Applications.....	1	Interface Schematics.....	6
Functional Block Diagram.....	1	Typical Performance Characteristics.....	7
General Description.....	1	Theory of Operation.....	18
Specifications.....	3	Applications Information.....	19
0.01 GHz to 1 GHz Frequency Range.....	3	Recommended Bias Sequencing	19
1 GHz to 6 GHz Frequency Range	3	Typical Application Circuit.....	19
6 GHz to 10 GHz Frequency Range	3	Evaluation Board.....	20
Absolute Maximum Ratings.....	5	Outline Dimensions.....	22
Thermal Resistance.....	5	Ordering Guide.....	22
ESD Caution.....	5	Evaluation Boards.....	22

REVISION HISTORY**3/2024—Rev. C to Rev. D**

Replaced Figure 66.....	16
Added Figure 67; Renumbered Sequentially	17

9/2022—Rev. B to Rev. C

Changes to Table 4.....	5
Changes to Table 5.....	5
Changes to Figure 2 and Table 6.....	6
Changes to Figure 3 to Figure 5.....	6
Changes to Figure 66.....	16
Changes to Figure 68.....	17
Changes to Theory of Operation Section and Figure 69.....	18
Changes to Figure 70.....	19
Changes to Applications Information Section.....	19
Changes to During Power-Down Section and Table 7.....	19
Changes to Figure 72 and Table 8.....	20

SPECIFICATIONS

0.01 GHZ TO 1 GHZ FREQUENCY RANGE

$V_{DD} = 5\text{ V}$, supply current (I_{DQ}) = 55 mA, and $T_A = 25^\circ\text{C}$, unless otherwise noted.

Table 1.

Parameter	Symbol	Min	Typ	Max	Unit	Test Conditions/Comments
FREQUENCY RANGE		0.01		1	GHz	
GAIN		12.5	15.5		dB	
Gain Variation over Temperature			0.005		dB/°C	
NOISE FIGURE			1.8		dB	
RETURN LOSS						
Input			22		dB	
Output			17		dB	
OUTPUT						
Output Power for 1 dB Compression	P1dB	17	20		dBm	
Saturated Output Power	P_{SAT}		20.5		dBm	
Output Third-Order Intercept	OIP3		33.5		dBm	Measurement taken at output power (P_{OUT}) per tone = 6 dBm
Output Second-Order Intercept	OIP2		43		dBm	Measurement taken at P_{OUT} per tone one = 6 dBm
POWER ADDED EFFICIENCY	PAE		30		%	Measured at P_{SAT}
SUPPLY CURRENT	I_{DQ}		55		mA	
SUPPLY VOLTAGE	V_{DD}	2	5	6	V	

1 GHZ TO 6 GHZ FREQUENCY RANGE

$V_{DD} = 5\text{ V}$, $I_{DQ} = 55\text{ mA}$, and $T_A = 25^\circ\text{C}$, unless otherwise noted.

Table 2.

Parameter	Symbol	Min	Typ	Max	Unit	Test Conditions/Comments
FREQUENCY RANGE		1		6	GHz	
GAIN		12	15		dB	
Gain Variation over Temperature			0.01		dB/°C	
NOISE FIGURE			1.7		dB	
RETURN LOSS						
Input			25		dB	
Output			18		dB	
OUTPUT						
Output Power for 1 dB Compression	P1dB	17	20		dBm	
Saturated Output Power	P_{SAT}		21		dBm	
Output Third-Order Intercept	OIP3		34		dBm	Measurement taken at P_{OUT} per tone = 6 dBm
Output Second-Order Intercept	OIP2		39		dBm	Measurement taken at P_{OUT} per tone = 6 dBm
POWER ADDED EFFICIENCY	PAE		34		%	Measured at P_{SAT}
SUPPLY CURRENT	I_{DQ}		55		mA	
SUPPLY VOLTAGE	V_{DD}	2	5	6	V	

6 GHZ TO 10 GHZ FREQUENCY RANGE

$V_{DD} = 5\text{ V}$, $I_{DQ} = 55\text{ mA}$, and $T_A = 25^\circ\text{C}$, unless otherwise noted.

Table 3.

Parameter	Symbol	Min	Typ	Max	Unit	Test Conditions/Comments
FREQUENCY RANGE		6		10	GHz	

SPECIFICATIONS

Table 3. (Continued)

Parameter	Symbol	Min	Typ	Max	Unit	Test Conditions/Comments
GAIN		11	14		dB	
Gain Variation over Temperature			0.018		dB/°C	
NOISE FIGURE			2		dB	
RETURN LOSS						
Input			15		dB	
Output			17		dB	
OUTPUT						
Output Power for 1 dB Compression	P1dB	13	16		dBm	
Saturated Output Power	P _{SAT}		19.5		dBm	
Output Third-Order Intercept	OIP3		33		dBm	Measurement taken at P _{OUT} per tone = 6 dBm
Output Second-Order Intercept	OIP2		40		dBm	Measurement taken at P _{OUT} per tone = 6 dBm
POWER ADDED EFFICIENCY	PAE		23		%	Measured at P _{SAT}
SUPPLY CURRENT	I _{DQ}		55		mA	
SUPPLY VOLTAGE	V _{DD}	2	5	6	V	

ABSOLUTE MAXIMUM RATINGS

Table 4.

Parameter ¹	Rating
Drain Bias Voltage (V_{DD})	7 V
Radio Frequency Input (RF_{IN}) Power	20 dBm
Channel Temperature	175°C
Continuous Power Dissipation (P_{DISS} , T = 85°C (Derate 8.7 mW/°C Above 85°C))	0.78 W
Storage Temperature Range	-65°C to +150°C
Operating Temperature Range	-40°C to +85°C
Electrostatic Discharge (ESD) Sensitivity Human Body Model (HBM)	500 V, Class 1B passed

¹ When referring to a single function of a multifunction pin in the parameters, only the portion of the pin name that is relevant to the specification is listed. For full pin names of multifunction pins, refer to the [Pin Configuration and Function Descriptions](#) section.

Stresses at or above those listed under Absolute Maximum Ratings may cause permanent damage to the product. This is a stress rating only; functional operation of the product at these or any other conditions above those indicated in the operational section of this specification is not implied. Operation beyond the maximum operating conditions for extended periods may affect product reliability.

THERMAL RESISTANCE

Thermal performance is directly linked to printed circuit board (PCB) design and operating environment. Close attention to PCB thermal design is required.

θ_{JC} is the junction to case thermal resistance.

Table 5. Thermal Resistance

Package Type	θ_{JC}	Unit
CP-6-12	115.35	°C/W

ESD CAUTION



ESD (electrostatic discharge) sensitive device. Charged devices and circuit boards can discharge without detection. Although this product features patented or proprietary protection circuitry, damage may occur on devices subjected to high energy ESD. Therefore, proper ESD precautions should be taken to avoid performance degradation or loss of functionality.

PIN CONFIGURATION AND FUNCTION DESCRIPTIONS

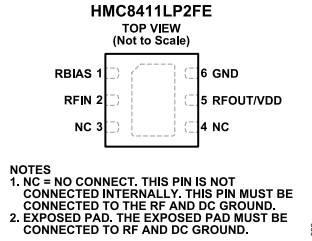

Figure 2. Pin Configuration

Table 6. Pin Function Descriptions

Pin No.	Mnemonic	Description
1	RBIAS	Bias Setting Resistor. Connect a resistor between RBIAS and VDD to set the quiescent drain current. See Figure 3 for the interface schematic.
2	RFIN	RF Input. The RFIN pin is ac-coupled and matched to 50 Ω. See Figure 4 for the interface schematic.
3, 4	NC	No Connect. This pin is not connected internally. For normal operation, this pin should be connected to ground.
5	RFOUT/VDD	RF Output and Drain Bias Voltage: The RF output is dc coupled and also serves as the drain biasing node. Connect a dc bias network to provide the drain current and ac-couple the RF output path. See Figure 5 for the interface schematic.
6	GND	Ground. This pin must be connected to the RF and dc ground. See Figure 6 for the interface schematic.
	EPAD	Exposed Ground Paddle. Connect the exposed Paddle to a ground plane which has low electrical and thermal impedance.

INTERFACE SCHEMATICS

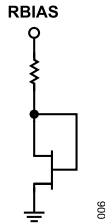

Figure 3. RBIAS Interface Schematic

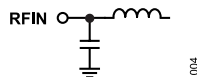

Figure 4. RFIN Interface Schematic

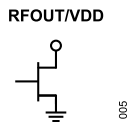

Figure 5. RFOUT/VDD Interface Schematic



Figure 6. GND Interface Schematic

TYPICAL PERFORMANCE CHARACTERISTICS

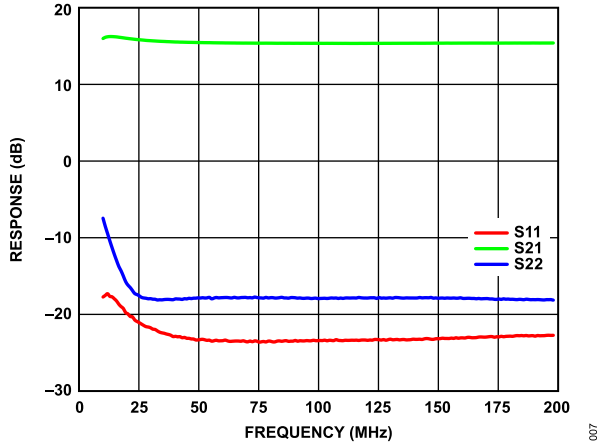

Figure 7. Gain and Return Loss (Response) vs. Frequency, 10 MHz to 200 MHz, $V_{DD} = 5\text{ V}$, $I_{DQ} = 55\text{ mA}$

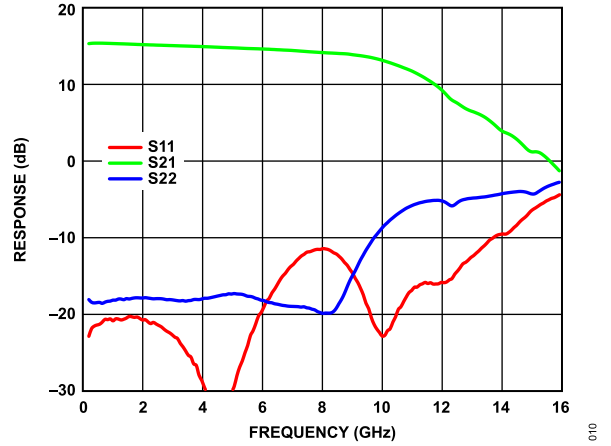

Figure 10. Broadband Gain and Return Loss (Response) vs. Frequency, 200 MHz to 16 GHz, $V_{DD} = 5\text{ V}$, $I_{DQ} = 55\text{ mA}$

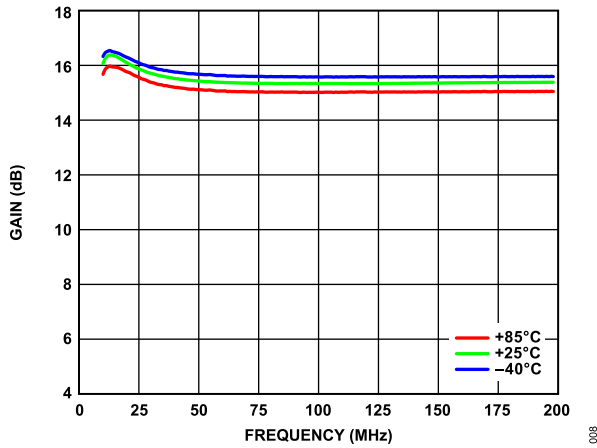

Figure 8. Gain vs. Frequency, 10 MHz to 200 MHz, for Various Temperatures, $V_{DD} = 5\text{ V}$, $I_{DQ} = 55\text{ mA}$

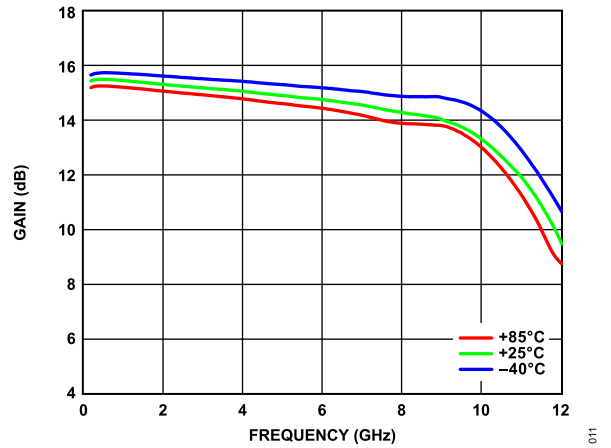

Figure 11. Gain vs. Frequency, 200 MHz to 12 GHz, for Various Temperatures, $V_{DD} = 5\text{ V}$, $I_{DQ} = 55\text{ mA}$

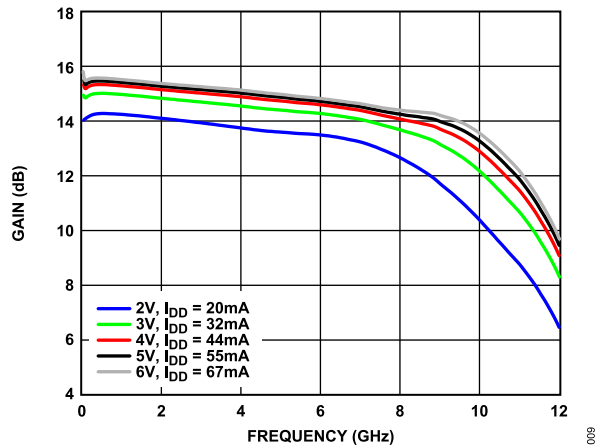

Figure 9. Gain vs. Frequency for Various Supply Voltages and Currents (I_{DD}), $R_{BIAS} = 1.1\text{ k}\Omega$

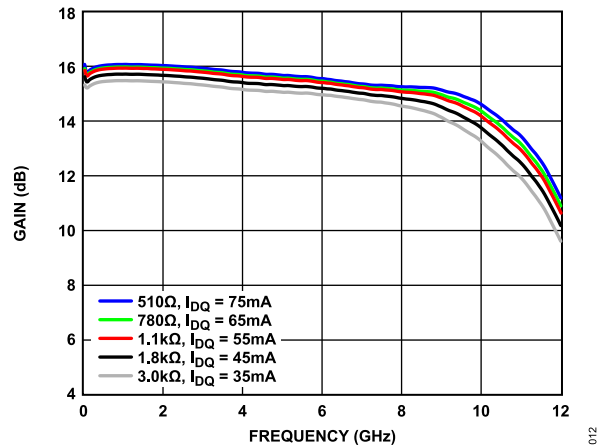

Figure 12. Gain vs. Frequency for Various Bias Resistor Values and I_{DQ} , $V_{DD} = 5\text{ V}$

TYPICAL PERFORMANCE CHARACTERISTICS

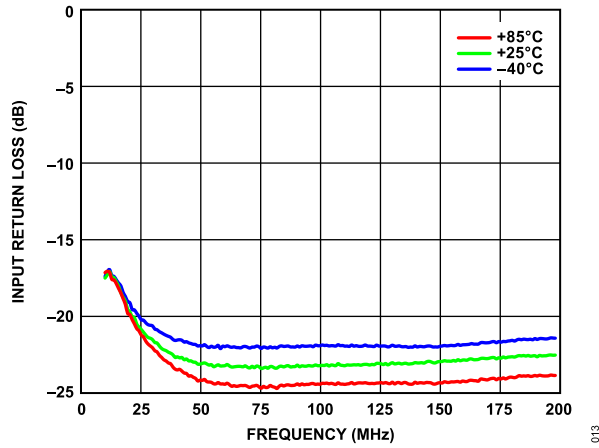

Figure 13. Input Return Loss vs. Frequency, 10 MHz to 200 MHz, for Various Temperatures, $V_{DD} = 5\text{ V}$, $I_{DQ} = 55\text{ mA}$

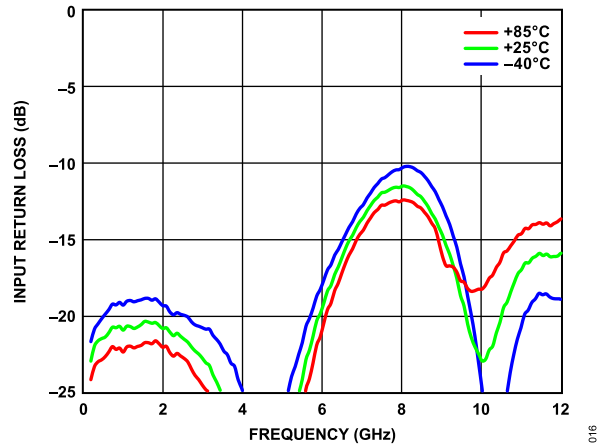

Figure 16. Input Return Loss vs. Frequency, 200 MHz to 12 GHz, for Various Temperatures, $V_{DD} = 5\text{ V}$, $I_{DQ} = 55\text{ mA}$

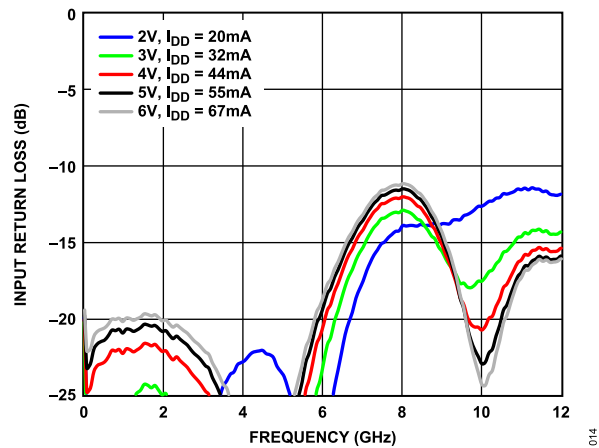

Figure 14. Input Return Loss vs. Frequency for Various Supply Voltages and I_{DQ} , $R_{BIAS} = 1.1\text{ k}\Omega$

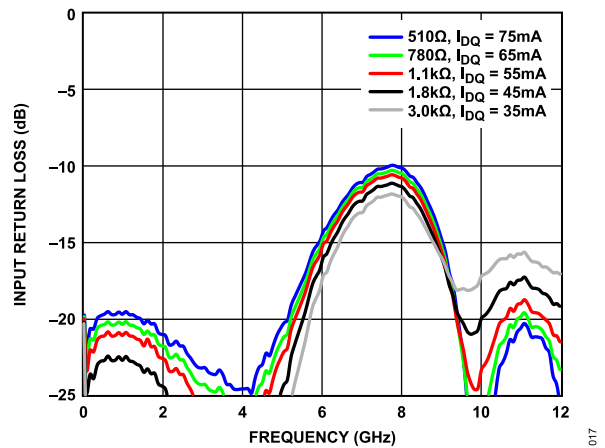

Figure 17. Input Return Loss vs. Frequency for Various Bias Resistor Values and I_{DQ} , $V_{DD} = 5\text{ V}$

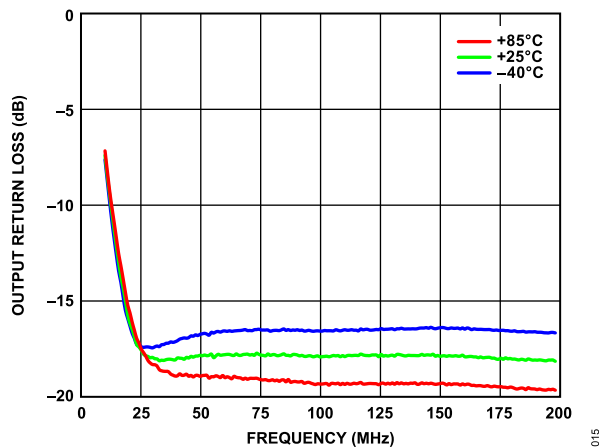

Figure 15. Output Return Loss vs. Frequency, 10 MHz to 200 MHz, for Various Temperatures, $V_{DD} = 5\text{ V}$, $I_{DQ} = 55\text{ mA}$

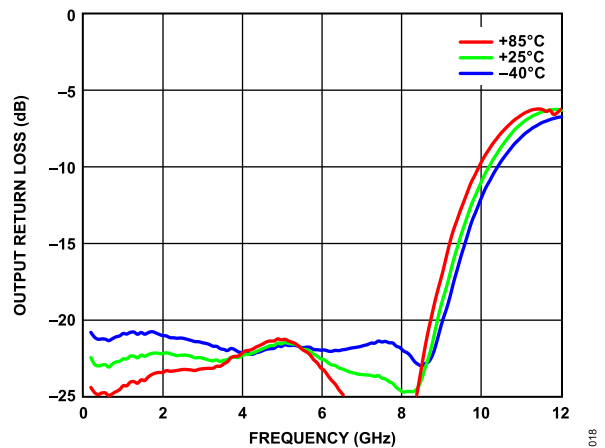

Figure 18. Output Return Loss vs. Frequency, 200 MHz to 12 GHz, for Various Temperatures, $V_{DD} = 5\text{ V}$, $I_{DQ} = 55\text{ mA}$

TYPICAL PERFORMANCE CHARACTERISTICS

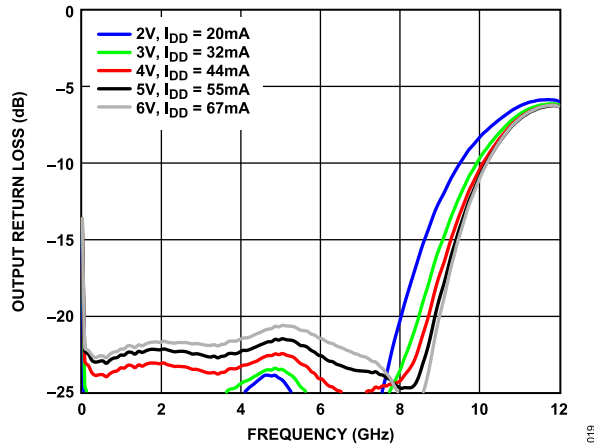

Figure 19. Output Return Loss vs. Frequency for Various Supply Voltages and I_{DD} , $R_{BIAS} = 1.1\text{ k}\Omega$

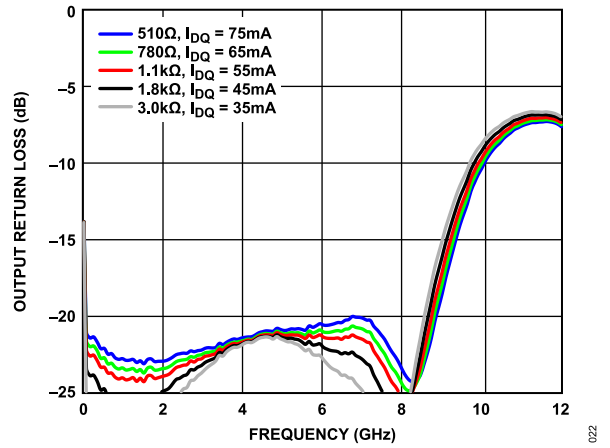

Figure 22. Output Return Loss vs. Frequency for Various Bias Resistor Values and I_{DQ} , $V_{DD} = 5\text{ V}$

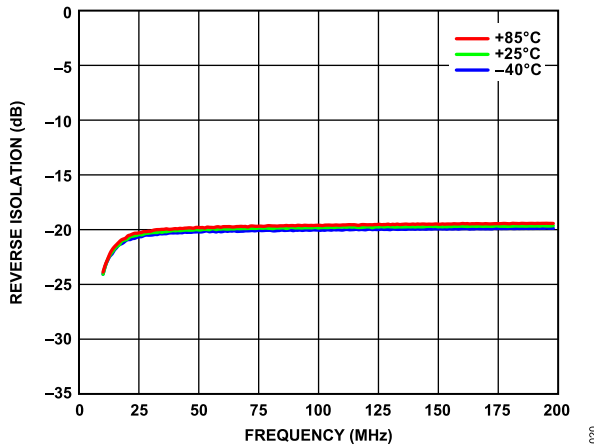

Figure 20. Reverse Isolation vs. Frequency, 10 MHz to 200 MHz, for Various Temperatures, $V_{DD} = 5\text{ V}$, $I_{DQ} = 55\text{ mA}$

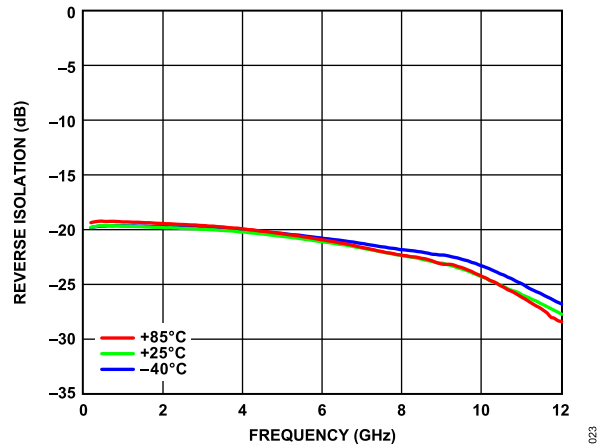

Figure 23. Reverse Isolation vs. Frequency, 200 MHz to 12 GHz, for Various Temperatures, $V_{DD} = 5\text{ V}$, $I_{DQ} = 55\text{ mA}$

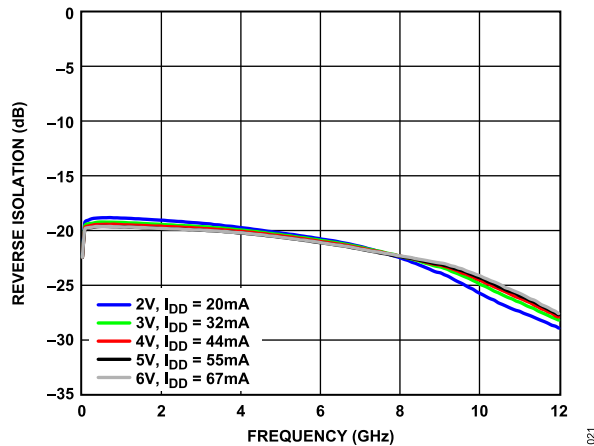

Figure 21. Reverse Isolation vs. Frequency for Various Supply Voltages and I_{DD} , $R_{BIAS} = 1.1\text{ k}\Omega$

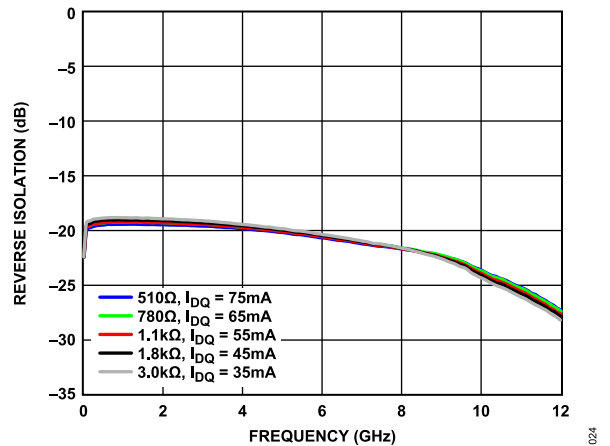

Figure 24. Reverse Isolation vs. Frequency for Various Bias Resistor Values and I_{DQ} , $V_{DD} = 5\text{ V}$

TYPICAL PERFORMANCE CHARACTERISTICS

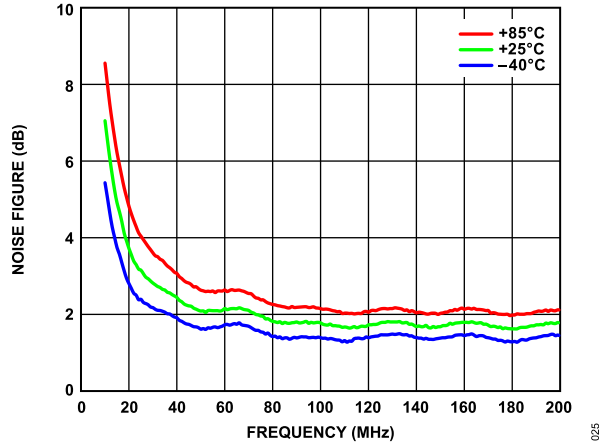

Figure 25. Noise Figure vs. Frequency, 10 MHz to 200 MHz, for Various Temperatures, $V_{DD} = 5\text{ V}$, $I_{DQ} = 55\text{ mA}$

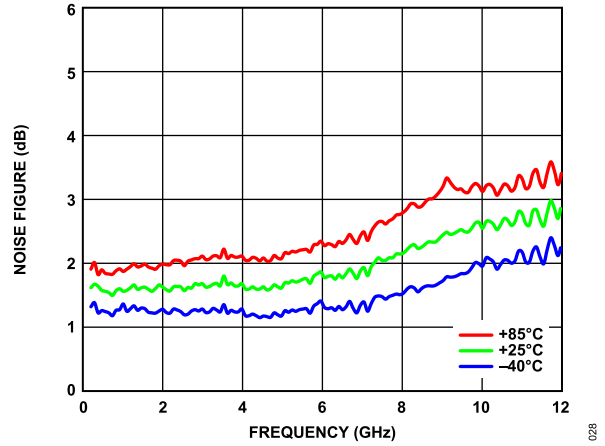

Figure 28. Noise Figure vs. Frequency, 200 MHz to 12 GHz, for Various Temperatures, $V_{DD} = 5\text{ V}$, $I_{DQ} = 55\text{ mA}$

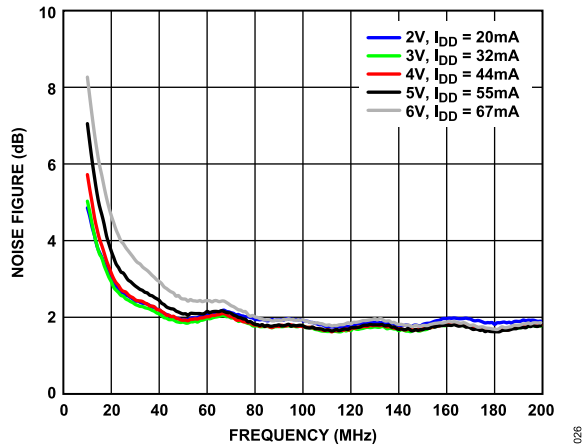

Figure 26. Noise Figure vs. Frequency, 10 MHz to 200 MHz, for Various Supply Voltages and I_{DQ} , $R_{BIAS} = 1.1\text{ k}\Omega$

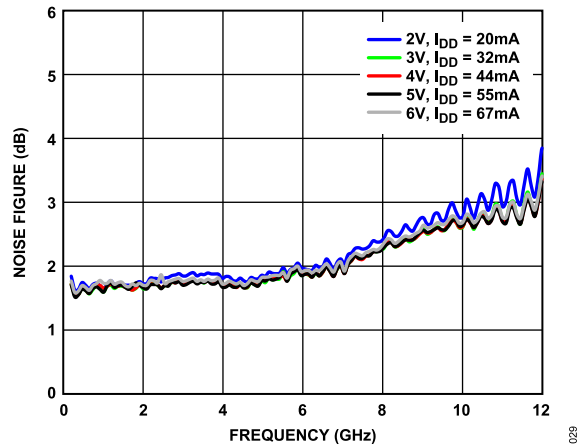

Figure 29. Noise Figure vs. Frequency, 200 MHz to 12 GHz, for Various Supply Voltages and I_{DQ} , $R_{BIAS} = 1.1\text{ k}\Omega$

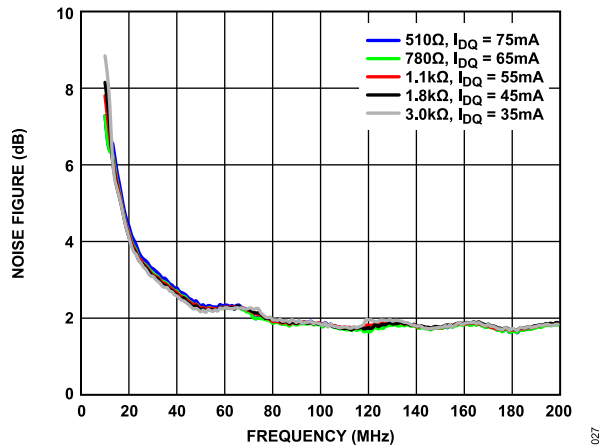

Figure 27. Noise Figure vs. Frequency, 10 MHz to 200 MHz, for Various Bias Resistor Values and I_{DQ} , $V_{DD} = 5\text{ V}$

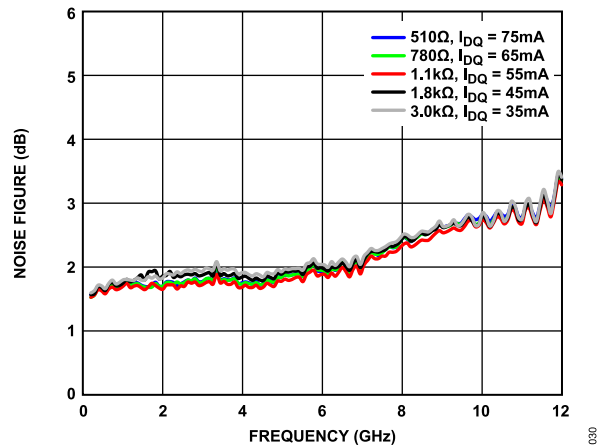

Figure 30. Noise Figure vs. Frequency, 200 MHz to 12 GHz, for Various Bias Resistor Values and I_{DQ} , $V_{DD} = 5\text{ V}$

TYPICAL PERFORMANCE CHARACTERISTICS

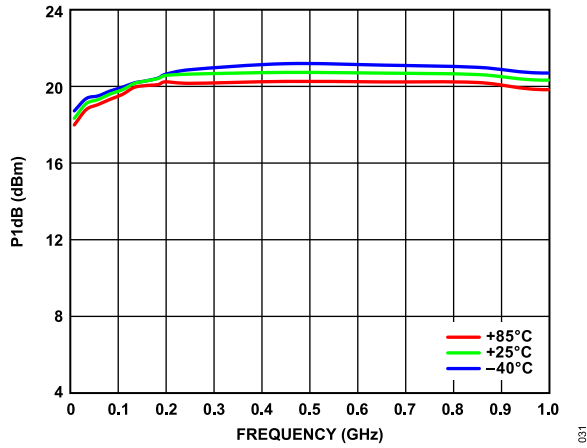

Figure 31. P1dB vs. Frequency, 0.01 GHz to 1.0 GHz, for Various Temperatures, $V_{DD} = 5\text{ V}$, $I_{DQ} = 55\text{ mA}$

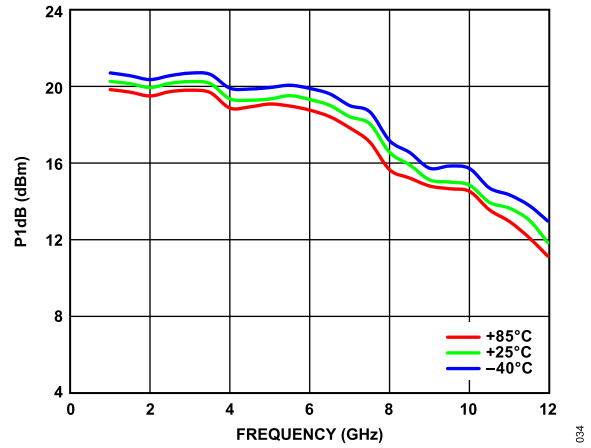

Figure 34. P1dB vs. Frequency, 1 GHz to 12 GHz, for Various Temperatures, $V_{DD} = 5\text{ V}$, $I_{DQ} = 55\text{ mA}$

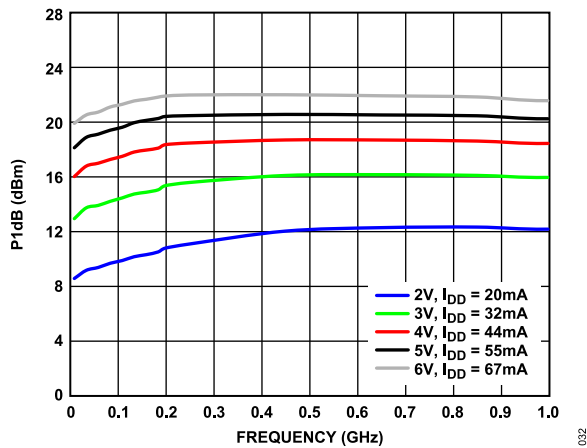

Figure 32. P1dB vs. Frequency, 0.01 GHz to 1.0 GHz, for Various Supply Voltages and I_{DQ} , $R_{BIAS} = 1.1\text{ k}\Omega$

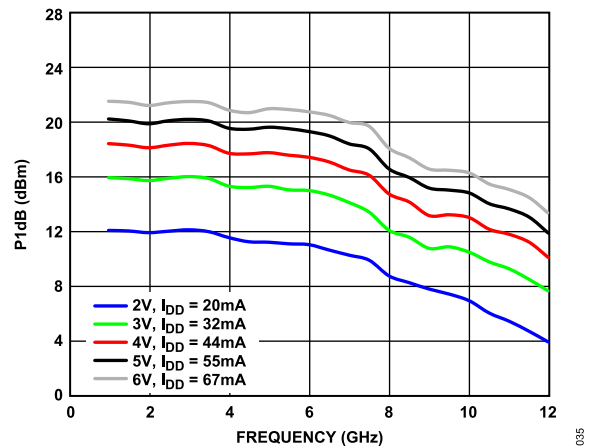

Figure 35. P1dB vs. Frequency, 1 GHz to 12 GHz, for Various Supply Voltages and I_{DQ} , $R_{BIAS} = 1.1\text{ k}\Omega$

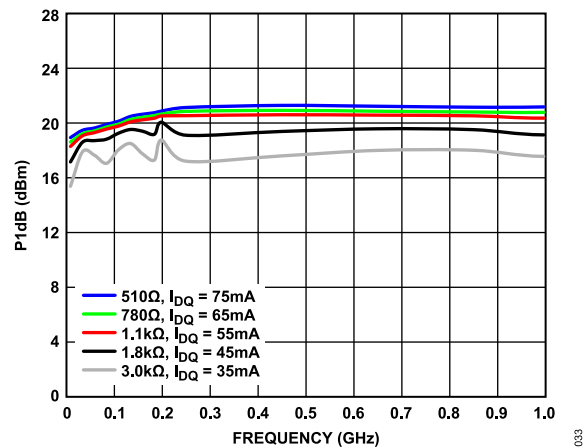

Figure 33. P1dB vs. Frequency, 0.01 GHz to 1.0 GHz, for Various Bias Resistor Values and I_{DQ} , $V_{DD} = 5\text{ V}$

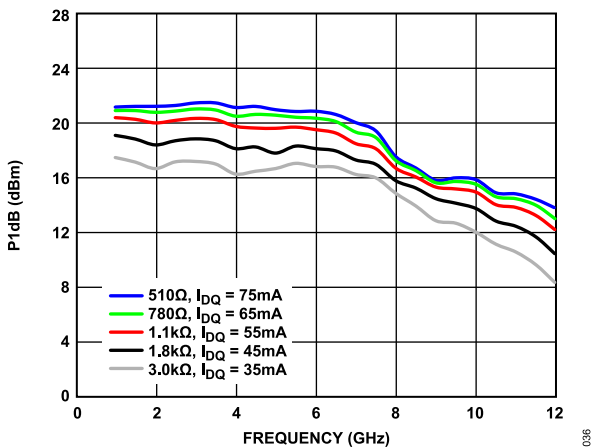

Figure 36. P1dB vs. Frequency, 1 GHz to 12 GHz, for Various Bias Resistor Values and I_{DQ} , $V_{DD} = 5\text{ V}$

TYPICAL PERFORMANCE CHARACTERISTICS

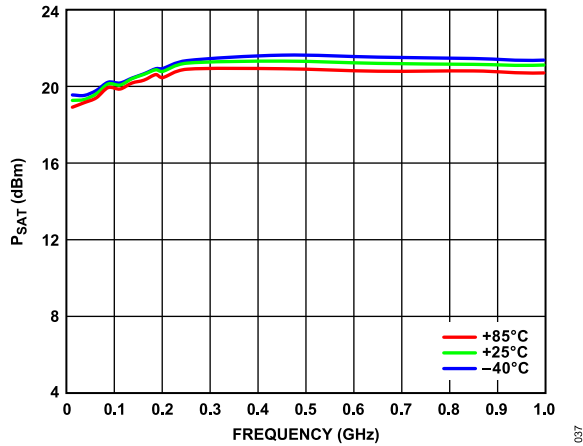

Figure 37. P_{SAT} vs. Frequency, 0.01 GHz to 1.0 GHz, for Various Temperatures, $V_{DD} = 5\text{ V}$, $I_{DQ} = 55\text{ mA}$

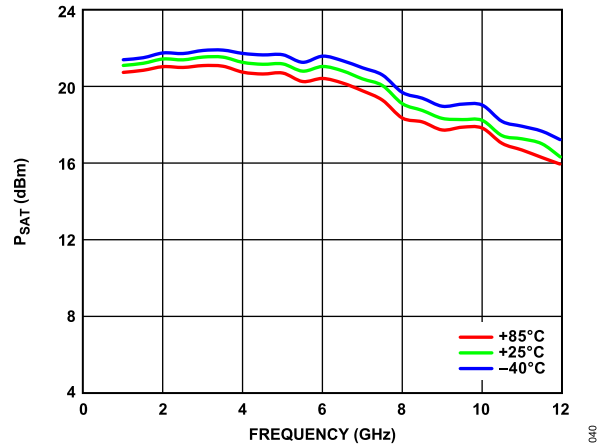

Figure 40. P_{SAT} vs. Frequency, 1 GHz to 12 GHz, for Various Temperatures, $V_{DD} = 5\text{ V}$, $I_{DQ} = 55\text{ mA}$

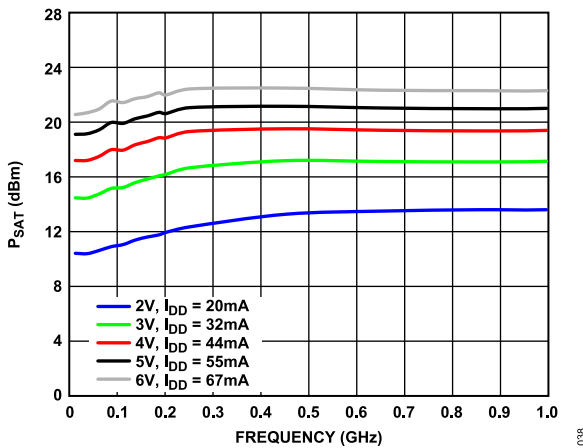

Figure 38. P_{SAT} vs. Frequency, 0.01 GHz to 1.0 GHz, for Various Supply Voltages and I_{DQ} , $R_{BIAS} = 1.1\text{ k}\Omega$

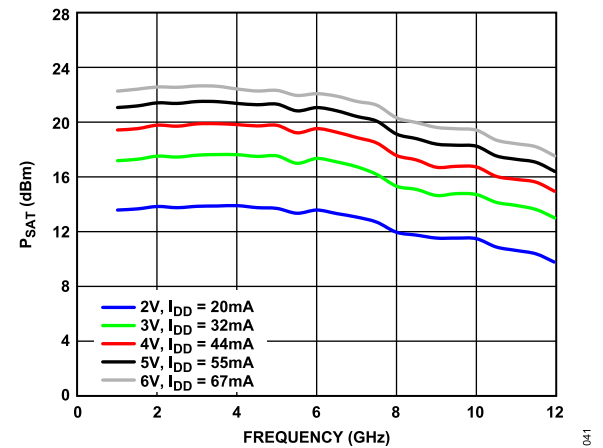

Figure 41. P_{SAT} vs. Frequency, 1 GHz to 12 GHz, for Various Supply Voltages and I_{DQ} , $R_{BIAS} = 1.1\text{ k}\Omega$

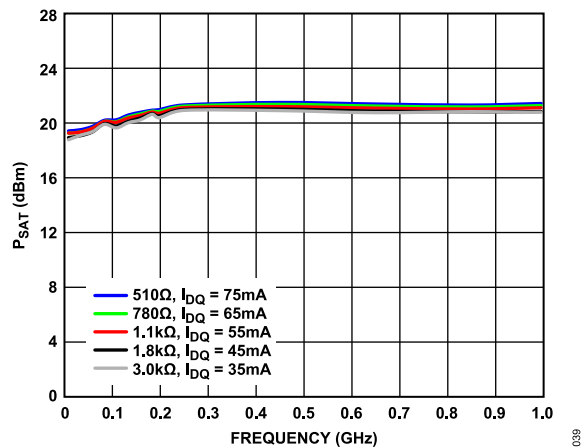

Figure 39. P_{SAT} vs. Frequency, 0.01 GHz to 1.0 GHz, for Various Bias Resistor Values and I_{DQ} , $V_{DD} = 5\text{ V}$

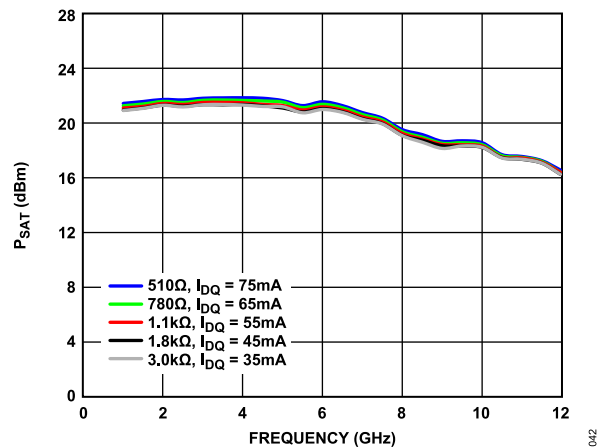

Figure 42. P_{SAT} vs. Frequency, 1 GHz to 12 GHz, for Various Bias Resistor Values and I_{DQ} , $V_{DD} = 5\text{ V}$

TYPICAL PERFORMANCE CHARACTERISTICS

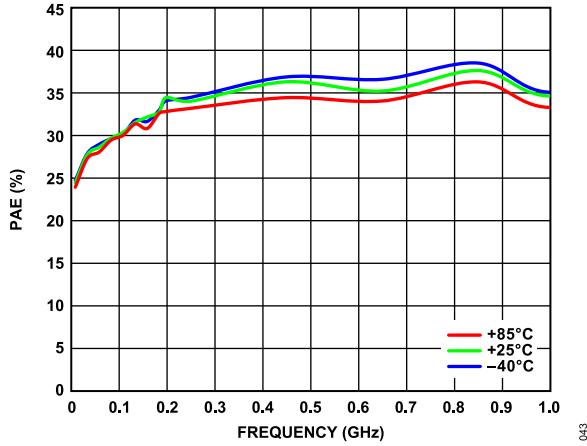

Figure 43. PAE vs. Frequency, 0.01 GHz to 1.0 GHz, for Various Temperatures, $V_{DD} = 5\text{ V}$, $I_{DQ} = 55\text{ mA}$

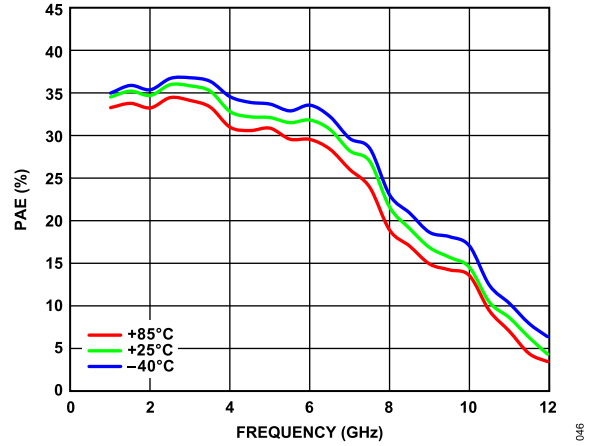

Figure 46. PAE vs. Frequency, 1 GHz to 12 GHz, for Various Temperatures, $V_{DD} = 5\text{ V}$, $I_{DQ} = 55\text{ mA}$

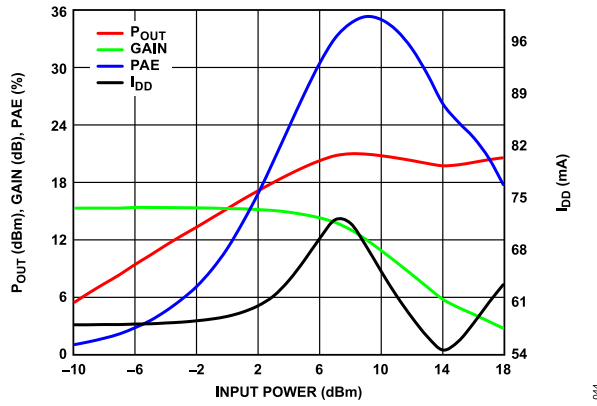

Figure 44. P_{OUT} , Gain, PAE, and I_{DD} vs. Input Power, Power Compression at 1 GHz, $V_{DD} = 5\text{ V}$, $I_{DQ} = 55\text{ mA}$

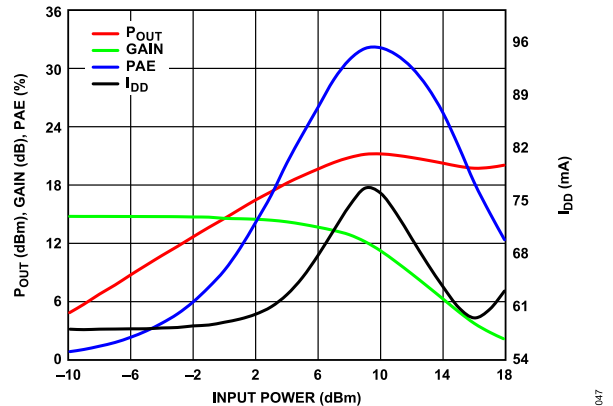

Figure 47. P_{OUT} , Gain, PAE, and I_{DD} vs. Input Power, Power Compression at 5 GHz, $V_{DD} = 5\text{ V}$, $I_{DQ} = 55\text{ mA}$

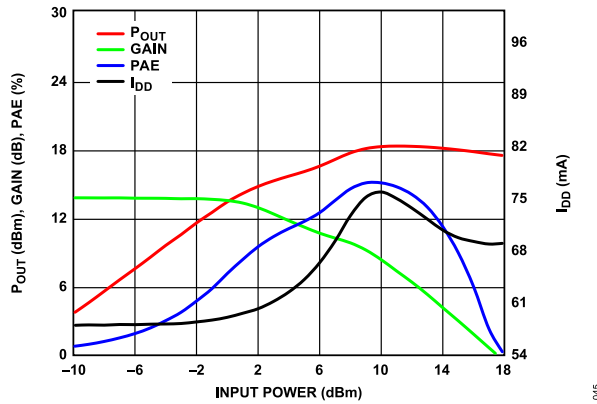

Figure 45. P_{OUT} , Gain, PAE, and I_{DD} vs. Input Power, Power Compression at 10 GHz, $V_{DD} = 5\text{ V}$, $I_{DQ} = 55\text{ mA}$

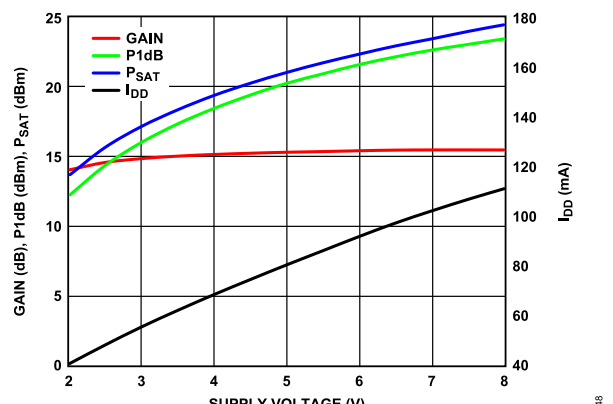

Figure 48. P_{1dB} , Gain, PAE, and I_{DD} vs. Supply Voltage, Power Compression at 1 GHz, $R_{BIAS} = 1.1\text{ k}\Omega$

TYPICAL PERFORMANCE CHARACTERISTICS

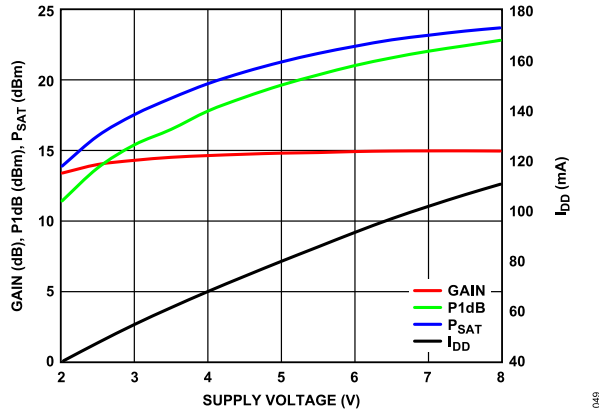

Figure 49. P1dB, Gain, PAE, and I_{DQ} vs. Input Power, Power Compression at 5 GHz, $R_{BIAS} = 1.1 \text{ k}\Omega$

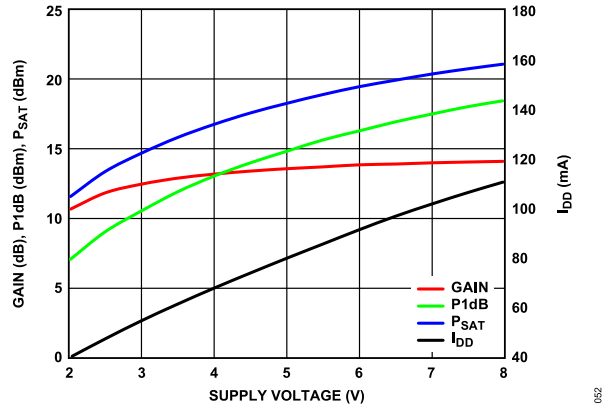

Figure 52. P1dB, Gain, PAE, and I_{DQ} vs. Input Power, Power Compression at 10 GHz, $R_{BIAS} = 1.1 \text{ k}\Omega$

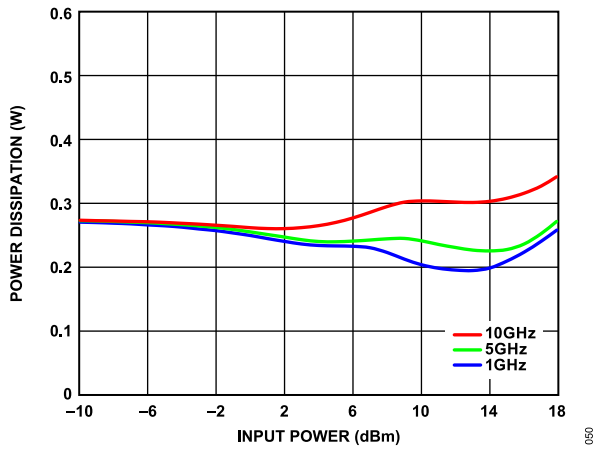

Figure 50. Power Dissipation vs. Input Power at $T_A = 85^\circ\text{C}$, $V_{DD} = 5 \text{ V}$, $I_{DQ} = 55 \text{ mA}$

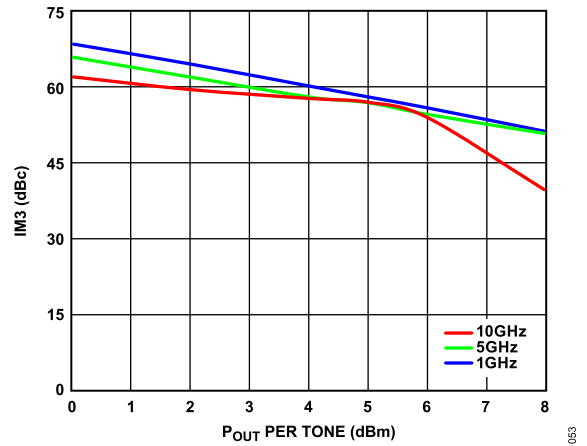

Figure 53. IM3 vs. P_{OUT} per Tone for Various Frequencies, $V_{DD} = 5 \text{ V}$, $I_{DQ} = 55 \text{ mA}$

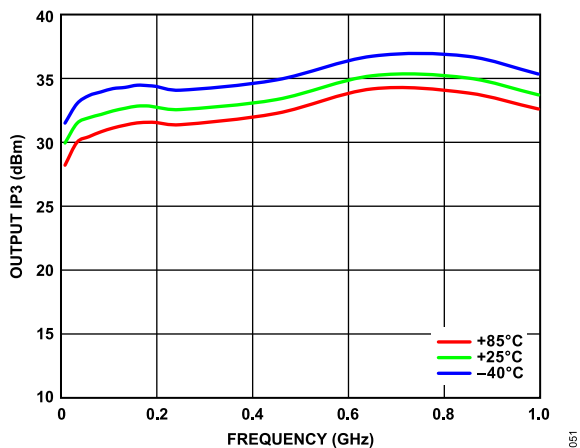

Figure 51. OIP3 vs. Frequency, 0.01 GHz to 1.0 GHz, for Various Temperatures, $V_{DD} = 5 \text{ V}$, $I_{DQ} = 55 \text{ mA}$

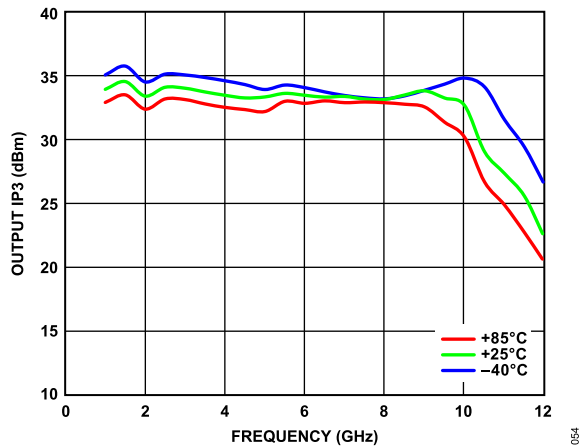

Figure 54. OIP3 vs. Frequency, 1 GHz to 12 GHz, for Various Temperatures, $V_{DD} = 5 \text{ V}$, $I_{DQ} = 55 \text{ mA}$

TYPICAL PERFORMANCE CHARACTERISTICS

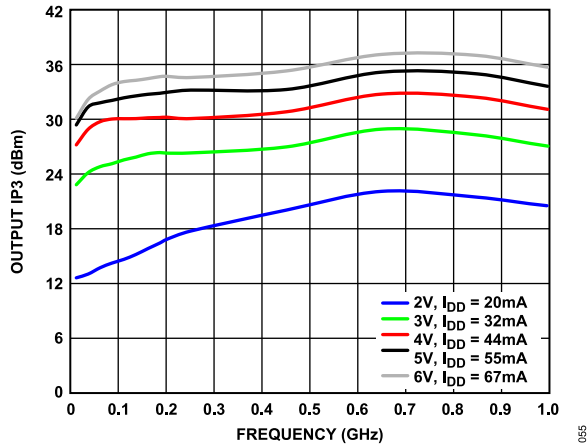

Figure 55. OIP3 vs. Frequency, 0.01 GHz to 1.0 GHz, for Various Supply Voltages and I_{DD} , $R_{BIAS} = 1.1\text{ k}\Omega$

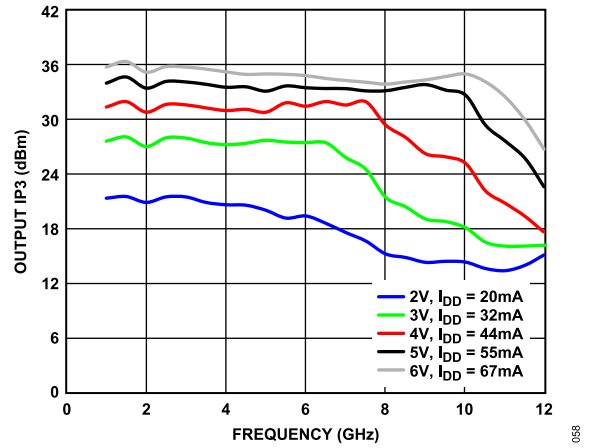

Figure 58. OIP3 vs. Frequency, 1 GHz to 12 GHz, for Various Supply Voltages and I_{DD} , $R_{BIAS} = 1.1\text{ k}\Omega$

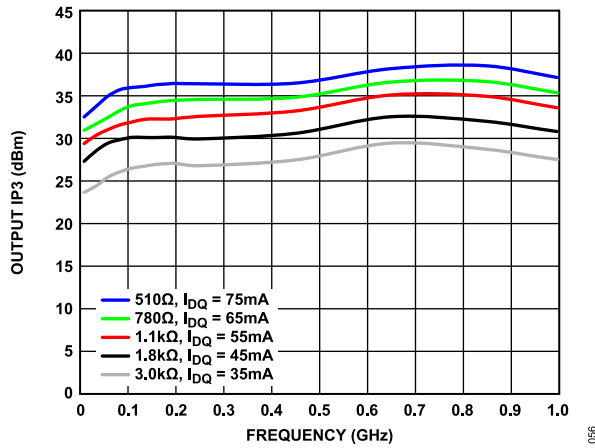

Figure 56. OIP3 vs. Frequency, 0.01 GHz to 1.0 GHz, for Various Bias Resistor Values and I_{DQ} , $V_{DD} = 5\text{ V}$

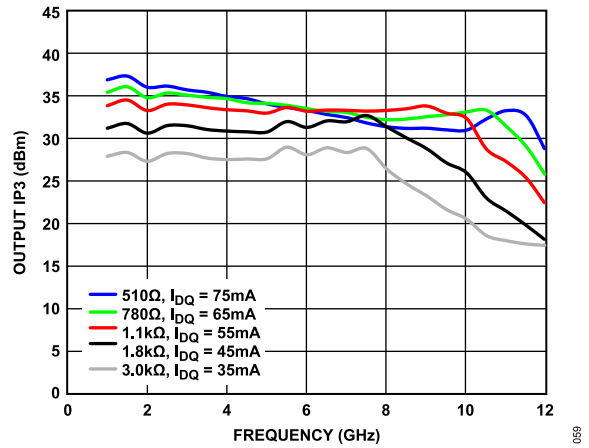

Figure 59. OIP3 vs. Frequency, 1 GHz to 12 GHz, for Various Bias Resistor Values and I_{DQ} , $V_{DD} = 5\text{ V}$

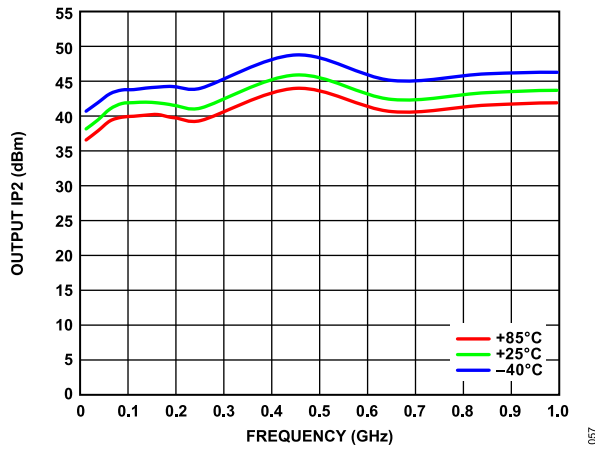

Figure 57. OIP2 vs. Frequency, 0.01 GHz to 1.0 GHz, for Various Temperatures, $V_{DD} = 5\text{ V}$, $I_{DQ} = 55\text{ mA}$

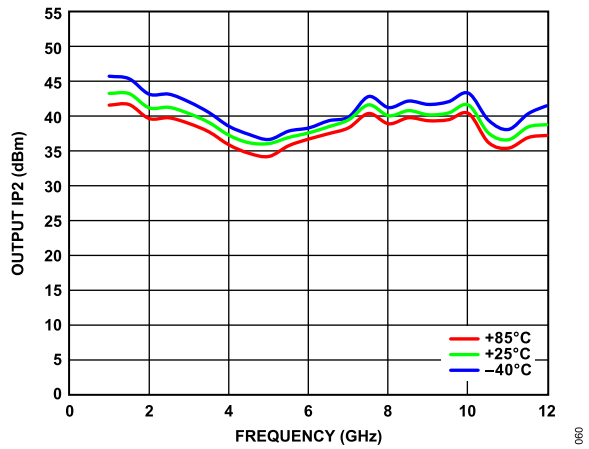

Figure 60. OIP2 vs. Frequency, 1 GHz to 12 GHz, for Various Temperatures, $V_{DD} = 5\text{ V}$, $I_{DQ} = 55\text{ mA}$

TYPICAL PERFORMANCE CHARACTERISTICS

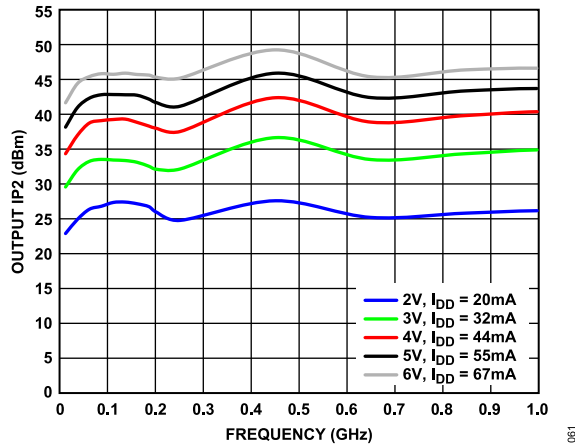

Figure 61. OIP2 vs. Frequency, 0.01 GHz to 1.0 GHz, for Various Supply Voltages and I_{DD} , $R_{BIAS} = 1.1\text{ k}\Omega$

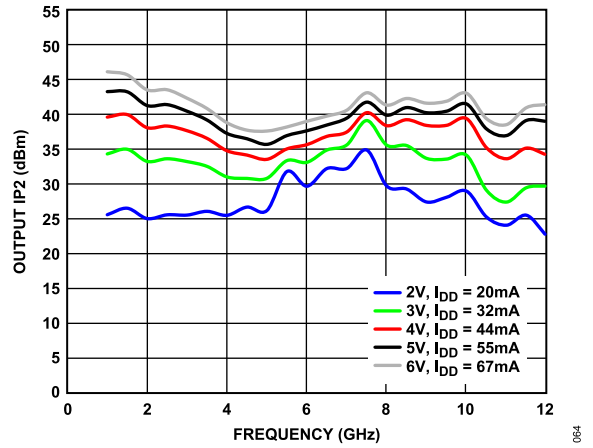

Figure 64. OIP2 vs. Frequency, 1 GHz to 12 GHz, for Various Supply Voltages and I_{DD} , $R_{BIAS} = 1.1\text{ k}\Omega$

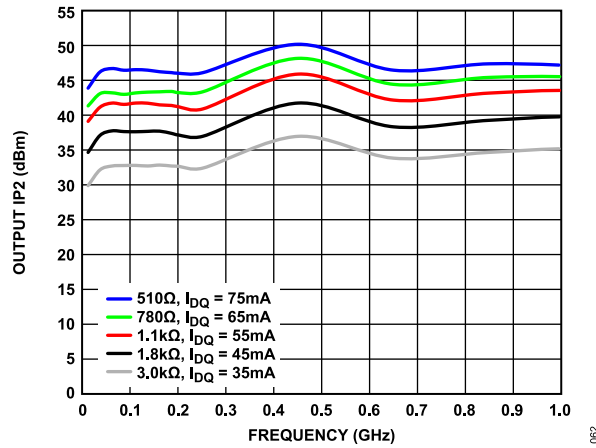

Figure 62. OIP2 vs. Frequency, 0.01 GHz to 1.0 GHz, for Various Bias Resistor Values and I_{DQ} , $V_{DD} = 5\text{ V}$

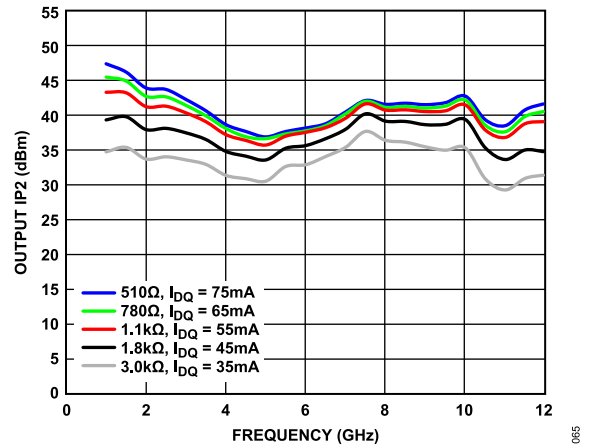

Figure 65. OIP2 vs. Frequency, 1 GHz to 12 GHz, for Various Bias Resistor Values and I_{DQ} , $V_{DD} = 5\text{ V}$

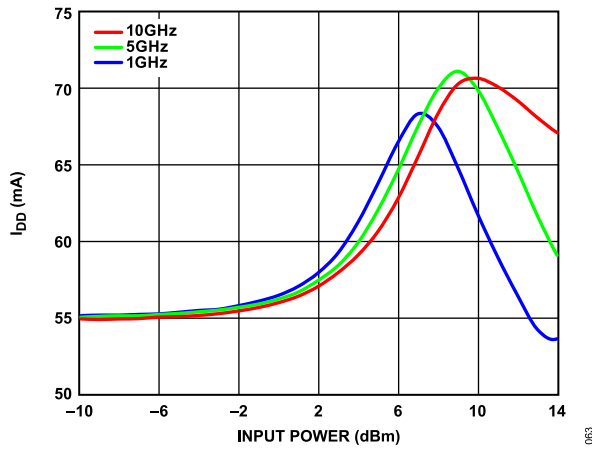

Figure 63. I_{DD} vs. Input Power for Various Frequencies, $V_{DD} = 5\text{ V}$

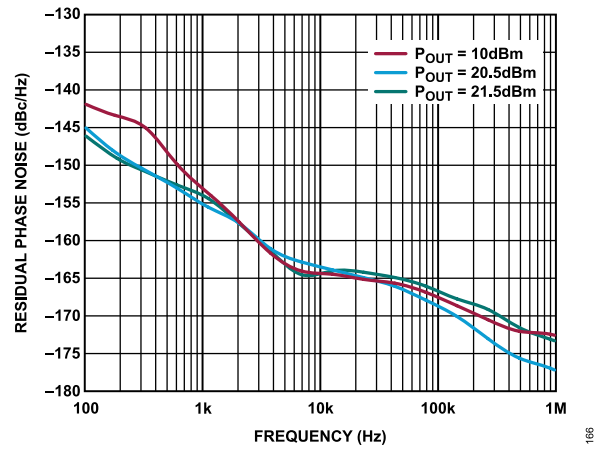

Figure 66. Residual Phase Noise vs. Frequency Offset at 1.5 GHz for Various P_{OUT} Values

TYPICAL PERFORMANCE CHARACTERISTICS

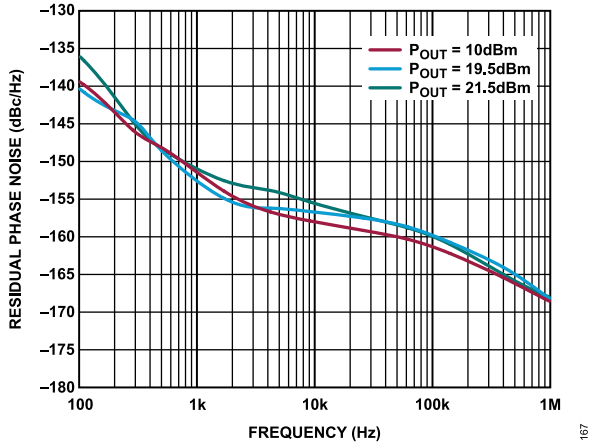

Figure 67. Residual Phase Noise vs. Frequency Offset at 6 GHz for Various P_{OUT} Values

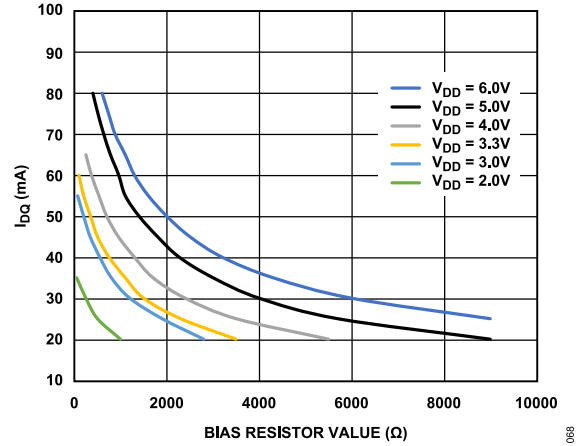

Figure 69. I_{DQ} vs. Bias Resistor Value and at Various V_{DD} Values

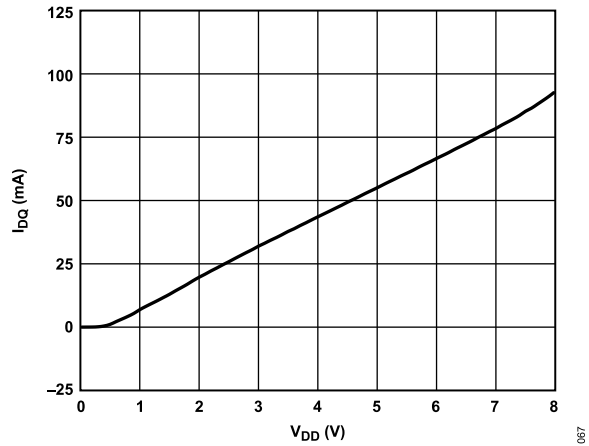

Figure 68. I_{DQ} vs. V_{DD} , Representative of a Typical Device, $R_{BIAS} = 1.1 \text{ k}\Omega$

THEORY OF OPERATION

The HMC8411LP2FE is a GaAs, MMIC, pHEMT, low noise wide-band amplifier.

The HMC8411LP2FE has single-ended input and output ports with impedances that nominally equal $50\ \Omega$ over the 0.01 GHz to 10 GHz frequency range. As a result, the device can be directly inserted into a $50\ \Omega$ system with external components on the RF input and output, as shown in Figure 71, without narrow-banded matching solutions. An external bias inductor and dc blocking capacitor are required on the VDD/RFOUT pin. A dc blocking capacitor is also required on the RFIN pin. On the RF input, there is an additional resistor, inductor, and capacitor (RLC) shunt network that ensures unconditional stability below 100 MHz. The bias current of

the device is set by a resistor that is connected between the RBIAS pin and the supply voltage.

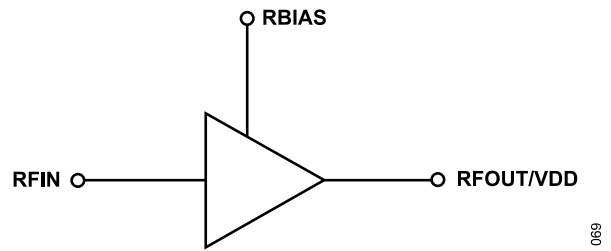

Figure 70. Simplified HMC8411LP2FE Block Diagram

069

APPLICATIONS INFORMATION

The basic connections for operating the HMC8411LP2FE are shown in Figure 71. AC couple the input and output of the HMC8411LP2FE with appropriately sized capacitors. 100 nF capacitors are recommended (ATC531Z104KT16T). A 5 V dc bias is supplied to the amplifier through the choke inductor connected to the VDD/RFOUT pin.

A 1.1 k Ω resistor connected between the RBIAS pin and the 5 V supply voltage sets the bias current to 55 mA .

Refer to Table 7 and Figure 69 for the recommended resistor values to set different bias currents.

RECOMMENDED BIAS SEQUENCING

During Power-Up

The recommended bias sequence during power-up follows:

1. Set V_{DD} to 5 V.
2. Apply the RF signal.

During Power-Down

The recommended bias sequence during power-down follows:

1. Turn off the RF signal.
2. Set V_{DD} to 0 V.

Table 7. Recommended Bias Resistor Values

R_{BIAS} (Ω)	I_{DQ} (mA)	I_{DQ_AMP} (mA)	I_{RBIAS} (mA)
400	80	75.97	4.03
510	75	71.32	3.68
635	70	66.64	3.36
780	65	61.95	3.05
960	60	57.27	2.73
1100	55	52.47	2.53
1400	50	47.82	2.18
1800	45	43.16	1.84
2270	40	38.45	1.55
3000	35	33.75	1.25
4000	30	29.15	0.85
5700	25	24.93	0.07
9000	20	19.95	0.05

TYPICAL APPLICATION CIRCUIT

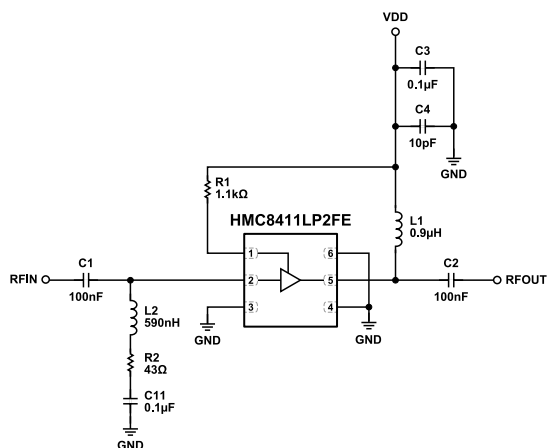

Figure 71. Typical Application Circuit

EVALUATION BOARD

The EV1HMC8411LP2F evaluation board is a 4-layer board fabricated using Rogers 4350 and using best practices for high frequency RF design. The RF input and RF output traces have a 50 Ω characteristic impedance.

The evaluation board and populated components operate over the -40°C to +85°C ambient temperature range. For proper bias sequence, see the [Applications Information](#) section.

The evaluation board schematic is shown in [Figure 73](#).

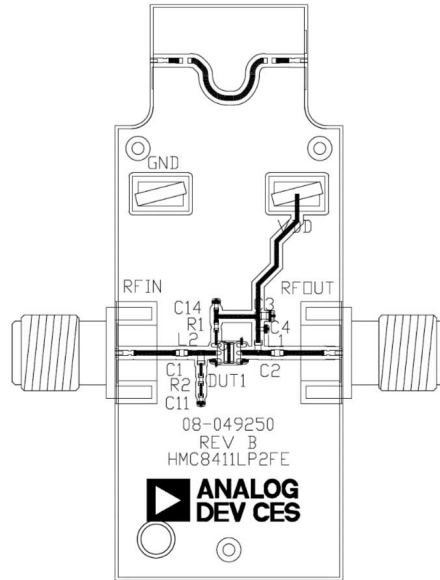

Figure 72. EV1HMC8411LP2F Printed Circuit Board (PCB)

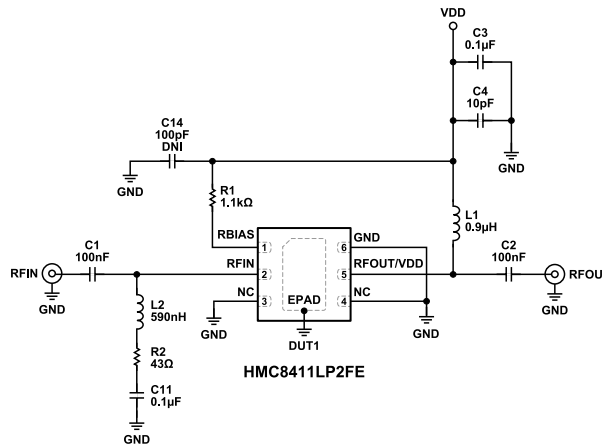

Figure 73. EV1HMC8411LP2F Evaluation Board Schematic

Table 8. Bill of Materials for Evaluation PCB EV1HMC8411LP2F

Item	Description
RFIN, RFOUT	PCB mount SMA RF connectors, SRI 21-146-1000-01
VDD, GND	DC bias test points
C1, C2	100 nF broadband dc blocking capacitors, ATC531Z104KT16T
C3	Capacitor, 0.1 µF, 0402 package
C4	Capacitor, 10 pF, 0201 package
C11	Capacitor, 0.1 µF, 0201 package
L1	Inductor, 0.9 µH, 0402, 5% ferrite, Coilcraft 0402DF-901XJRW

EVALUATION BOARD**Table 8. Bill of Materials for Evaluation PCB EV1HMC8411LP2F (Continued)**

Item	Description
L2	Inductor, 590 nH, 0402, 5% ferrite, Coilcraft 0402DF-591XJRU
R1	1.1 k Ω resistor, 0201 package
R2	43 Ω resistor, 0201 package
DUT1	IC, HMC8411LP2FE

OUTLINE DIMENSIONS

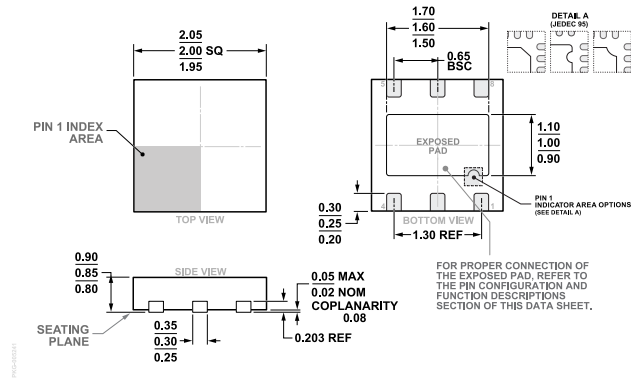

**Figure 74. 6-Lead Lead Frame Chip Scale Package [LFCSP]
2 mm x 2 mm Body and 0.85 mm Package Height
(CP-6-12)
Dimensions shown in millimeters**

Updated: August 09, 2023

ORDERING GUIDE

Model ¹	Temperature Range	Package Description	Packing Quantity	Package Option
HMC8411LP2FE	-40°C to +85°C	6-Lead LFCSP (2mm x 2mm)	Cut Tape, 500	CP-6-12
HMC8411LP2FETR	-40°C to +85°C	6-Lead LFCSP (2mm x 2mm)	Reel, 500	CP-6-12

¹ Z = RoHS Compliant Part.

EVALUATION BOARDS

Model	Description
EV1HMC8411LP2F	Evaluation Board

Looking for pricing, stock, or lifecycle information?

Click below to explore more details on WIN SOURCE:

 [View HMC8411LP2FE on WIN SOURCE](#)

 [Analog Devices Inc. Information](#)

Optimize Your Supply Chain with WIN SOURCE Solutions

-  Global Sourcing Solution
-  Obsolete Management
-  Cost Control Management
-  Shortage Management
-  Alternative Solution
-  Excess Inventory Management