



**THE DATASHEET OF
HCM491200000ABJT**



AT-CUT CRYSTAL UNIT (SMD · Metal-can Type)

RoHS compliant

HCM49

1,000pcs/reel



■ FEATURES

- Frequency range : 3.5 ~ 50.0MHz
- External dimensions (mm)
L : 11.4 x W : 4.7 x H : 4.3
- Applications
Consumer products

■ DIMENSION [mm]

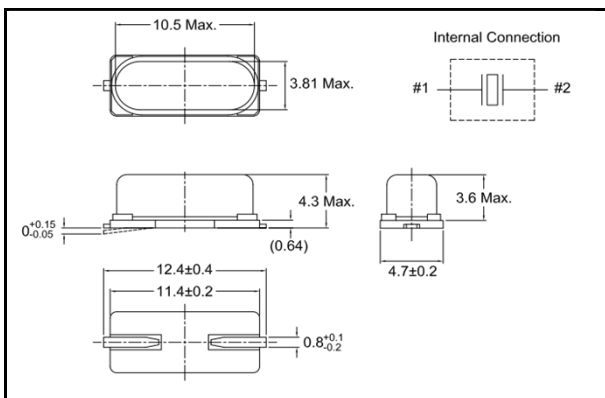

■ SOLDER PAD LAYOUT [mm]

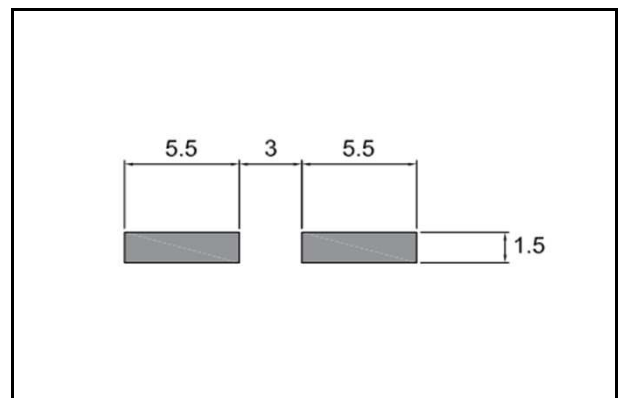

■ STANDARD SPECIFICATIONS

Item	Model	HCM49	Conditions
Nominal Frequency	f_0	3.5MHz ~ 30.0MHz (Fundamental) 30.0MHz ~ 50.0MHz (3rd Overtone)	Please contact us for frequencies available
Frequency Tolerance	$\Delta f/f_0$	±30ppm	at 25°C
Frequency Tolerance over Operating Temperature Range	$\Delta f/f_0$	below 6.0MHz: ±50ppm above 6.0MHz: ±30ppm	-10°C ~ +60°C
Operating Temperature Range	T_{OPR}	-40°C ~ +85°C	
Storage Temperature Range	T_{STR}	-55°C ~ +125°C	
Motional (series) resistance	R_1	Refer to the following table	at 25°C
Load capacitance	C_L	Fundamental: 10.0pF ~ ∞ 3rd Overtone: 5.0pF ~ ∞	Please specify your requirement
Shunt capacitance	C_0	7.0pF Max.	
Level of drive	D_L	100 μW	
Insulation Resistance	I_R	500MΩ Min.	DC100V ± 15V
Aging (first year)	$\Delta f/f_0$	±5ppm Max.	25°C ± 3°C

■ MOTIONAL (SERIES) RESISTANCE (R₁)

Freq. Range (MHz)	3.5 ≤ f ₀ < 4.0	4.0 ≤ f ₀ < 6.0	6.0 ≤ f ₀ < 10.0	10.0 ≤ f ₀ < 14.0	14.0 ≤ f ₀ < 30.0	30.0 ≤ f ₀ < 36.0	36.0 ≤ f ₀ ≤ 50.0
Mode	Fundamental	Fundamental	Fundamental	Fundamental	Fundamental	3rd Overtone	3rd Overtone
R ₁	200Ω Max.	150Ω Max.	100Ω Max.	80Ω Max.	50Ω Max.	140Ω Max.	100Ω Max.

■ PART NUMBERING SYSTEM

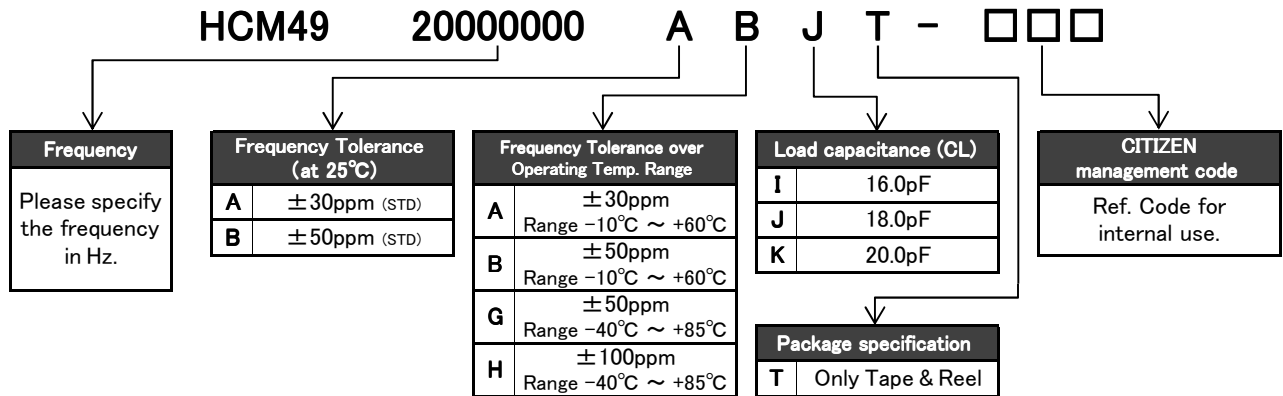

*Please contact us for specifications available.

■ Part Marking [standard]



f : The first 4 digits of Frequency including the decimal point

C : Manufacture's ID Code

y : The last digit of production year

m : Production month (See Table.1)

Table.1

Month	Jan	Feb	...	Sep	Oct	Nov	Dec
Code	1	2	...	9	X	Y	Z

■ Reflow profile

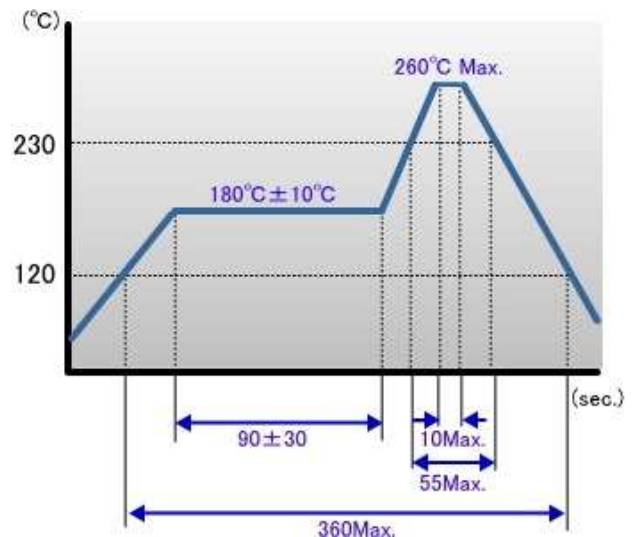

■ Packing

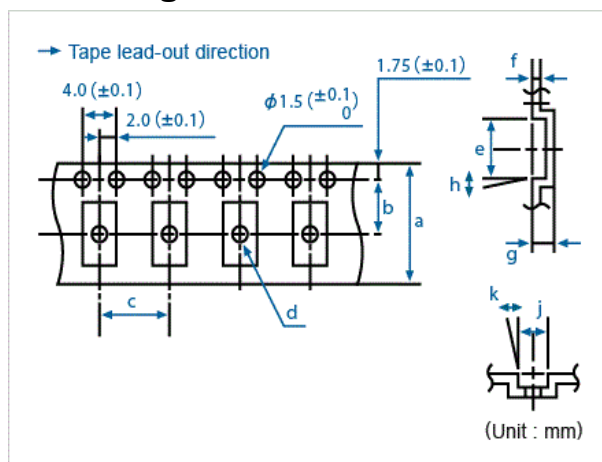

Conforming to JIS C 0806 TB1208NEIAJ and RC-1009B TE1208N

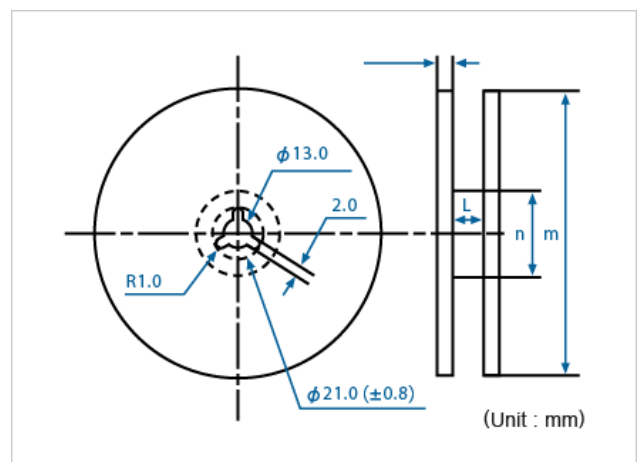

Conforming to JIS C 0806 R12R and EIAJ RC-1009B R15



Q'ty/reel	a	b	c	d (φ)	e	f	g	h	j	k	l	m (φ)	n (φ)
1,000	24.0	11.5	12.0	2.0	14.1	0.4	4.2	5°	6.5	5°	25.5	330	80

Product specifications are subject to change without notice.

Rev.2

Looking for pricing, stock, or lifecycle information?

Click below to explore more details on WIN SOURCE:

-  [View HCM4912000000ABJT on WIN SOURCE](#)
-  [Citizen Finedevice Co Ltd Information](#)

Optimize Your Supply Chain with WIN SOURCE Solutions

-  Global Sourcing Solution
-  Obsolete Management
-  Cost Control Management
-  Shortage Management
-  Alternative Solution
-  Excess Inventory Management