



**THE DATASHEET OF
TL3365AF180QG**



TL3365 SERIES TACT SWITCH

ANTI-VANDAL SWITCHES
 DETECTOR SWITCHES
 DIP SWITCHES
 KEYLOCK SWITCHES
 NAVIGATION SWITCHES
 PUSHBUTTON SWITCHES
 ROCKER SWITCHES
 ROTARY SWITCHES
 SLIDE SWITCHES
 SNAP ACTION SWITCHES
TACTILE SWITCHES
 TOGGLE SWITCHES
 CAP OPTIONS



APPLICATIONS / MARKETS

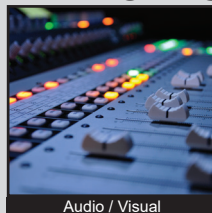

Audio / Visual

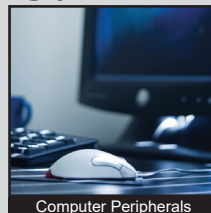

Computer Peripherals

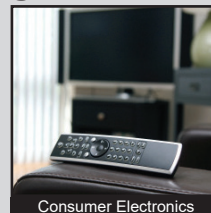

Consumer Electronics

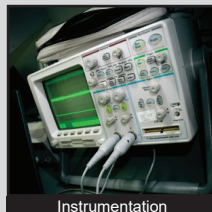

Instrumentation



Telecommunication



Medical Equipment

RoHS

SPECIFICATIONS

Electrical Rating: 50mA @ 12VDC
Electrical Life: 100,000 Cycles
Mechanical Life: 100,000 Cycles
Contact Resistance: 100mΩ Max. Initial
Insulation Resistance: 100M Ω at 100VDC
Dielectric Strength: 250VAC for 1 min.
Operating Temperature: -20°C to 70°C
Storage Temperature: -30°C to 80°C
Operating Force: 180gf, 250gf, or 400gf
Travel: 0.2mm
Contact Arrangement: SPST

FEATURES & BENEFITS

- Ultraminiature
- Surface mount
- Multiple actuation force options

PART NUMBER CONFIGURATOR

Series	Model	Actuator Option	Actuation Force	Contact Material	Termination
<input type="text" value="TL"/>	<input type="text" value="3365"/>	<input type="text" value="A - 2.50mm"/>	<input type="text" value="F180 - 180 gf"/> <input type="text" value="F250 - 250 gf"/> <input type="text" value="F400 - 400 gf"/>	<input type="text" value="Q - Silver"/>	<input type="text" value="G - Gullwing"/>

Specifications subject to change without notice 9.29.2022



E-SWITCH®

www.e-switch.com

800.867.2717

1

TL3365 SERIES TACT SWITCH

BODY DIMENSIONS

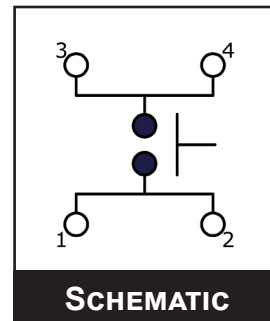
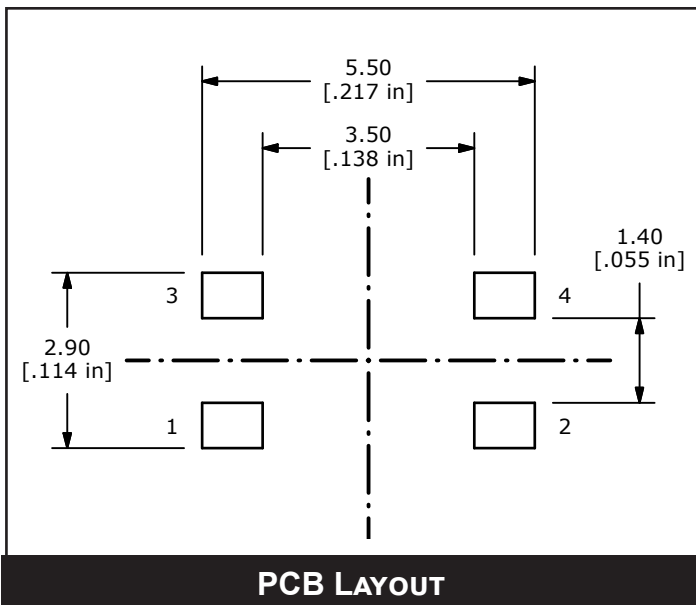
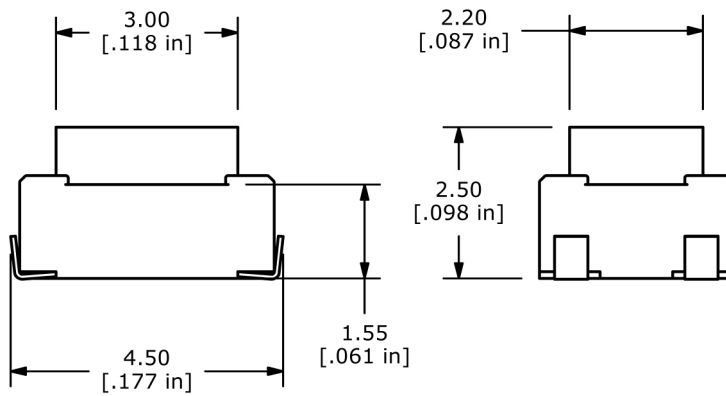
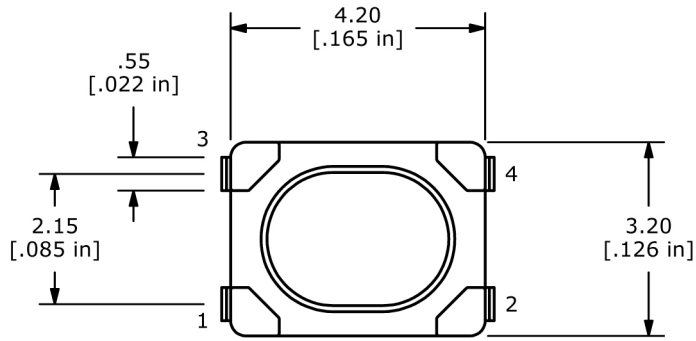

- ANTI-VANDAL SWITCHES
- DETECTOR SWITCHES
- DIP SWITCHES
- KEYLOCK SWITCHES
- NAVIGATION SWITCHES
- PUSHBUTTON SWITCHES
- ROCKER SWITCHES
- ROTARY SWITCHES
- SLIDE SWITCHES
- SNAP ACTION SWITCHES
- TACTILE SWITCHES**
- TOGGLE SWITCHES
- CAP OPTIONS



Looking for pricing, stock, or lifecycle information?

Click below to explore more details on WIN SOURCE:

 [View TL3365AF180QG on WIN SOURCE](#)

 [E-Switch Information](#)

Optimize Your Supply Chain with WIN SOURCE Solutions

-  Global Sourcing Solution
-  Obsolete Management
-  Cost Control Management
-  Shortage Management
-  Alternative Solution
-  Excess Inventory Management