







**THE DATASHEET OF
S912ZVMBA6F0MLH**





S12 MagniV Mixed-Signal MCUs S12ZVMB Family

Integrated solution for reversible DC motor control applications with H-Bridge

Features

-  DC Motor Control
-  Integrated LIN PHY
-  V_{REG} for 12 V Supply
-  4-ch. MOSFET Gate driver

-  Ultra-reliable Industrial
-  AEC-Q100 Grade0
(150 °C Ta / 175 °C Tj)

Product One-Pager

System in a Package—Highly integrated solution ideal for mechatronic approach to DC motors controlled by LIN or PWM command

Scalable—48/64 pin, up to 64 KB flash, up to 150 °C Ta

High reliability—High immunity to EMI and ESD stresses, LIN 2.x compliant with +/- 8 kV ESD capability

Low system cost—Operating straight from car battery, integrated PHY for LIN, 4-channel motor control MOSFET gate pre-drivers and op-amp for current sensing

Enablement—Supported by comprehensive hardware and software solution

S12ZVMB Specifications

Core	S12Z; 32 MHz bus	HS-Driver	2-ch. 12 V
Flash	48-64 KB	Gate Driver	4-ch. FET Gate driver
RAM	4 KB	PWM	6-ch. motor control PWM
EEPROM	512 B	PTU	Triggering ADC & PWM
Phy	LIN	ADC	5-9 ch, 10 bit
SCI/SPI	2/1	OpAmp	1 x for current sensing
HVI	3	EVDD	1-ch. 5 V / 20 mA (source)
Timer	4ch + 4ch 16-bit	12V VREG	70 mA (170 mA with ext. ballast)
Temp	Up to 150 °C Ta / 175 °C Tj	Op Range	7 V–20 V

Sample Part Numbers

Part Number	Flash	Temp Range	Package	Available	Test Coverage
P912ZVMB A64F0MLF	64 KB	-40 °C to 125 °C	48 LQFP	Now	3-Temp
P912ZVMB A64F0WLF	64 KB	-40 °C to 150 °C	48 LQFP	Now	3-Temp
P912ZVMB A64F0MLH	64 KB	-40 °C to 125 °C	64 LQFP	Now	3-Temp

Product Block Diagram

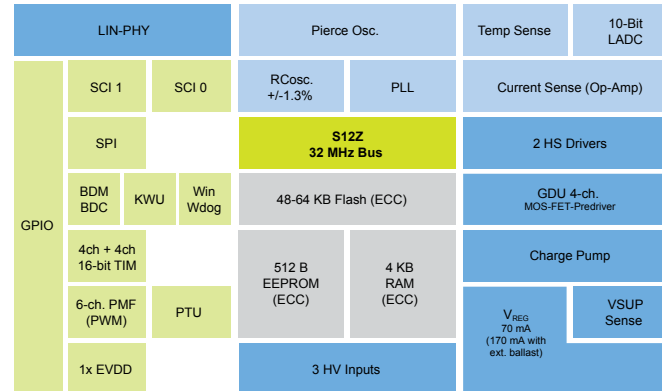

Application Example Block Diagram

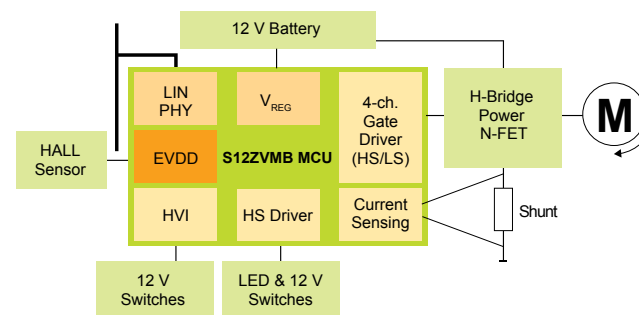

Target Applications

- ▶ Anti-Pinch window lift
- ▶ Sunroof
- ▶ Automatic doors
- ▶ Power lift gate
- ▶ Seat adjustment
- ▶ Valves (powertrain)
- ▶ Seat belt pretensioner

Enablement Tools

- ▶ Evaluation Board
–X-S12ZVMBEVB
- ▶ Compiler/Debugger
–CodeWarrior® IDE
–Cosmic IDE
- ▶ LIN Stack

Availability

Samples & tools available in limited quantity. Please contact local sales representative



www.NXP.com/S12ZVMB

NXP, the NXP logo, CodeWarrior and MagniV are trademarks of NXP B.V. All other product or service names are the property of their respective owners. © 2016 NXP B.V.

Document Number: S12ZVMBF5 REV 0



Looking for pricing, stock, or lifecycle information?

Click below to explore more details on WIN SOURCE:

 [View S912ZVMBA6F0MLH on WIN SOURCE](#)

 [NXP / Nexperia Information](#)

Optimize Your Supply Chain with WIN SOURCE Solutions

-  Global Sourcing Solution
-  Obsolete Management
-  Cost Control Management
-  Shortage Management
-  Alternative Solution
-  Excess Inventory Management