



**THE DATASHEET OF
STRVS248X02C**



ST repetitive voltage suppressor

Datasheet – production data

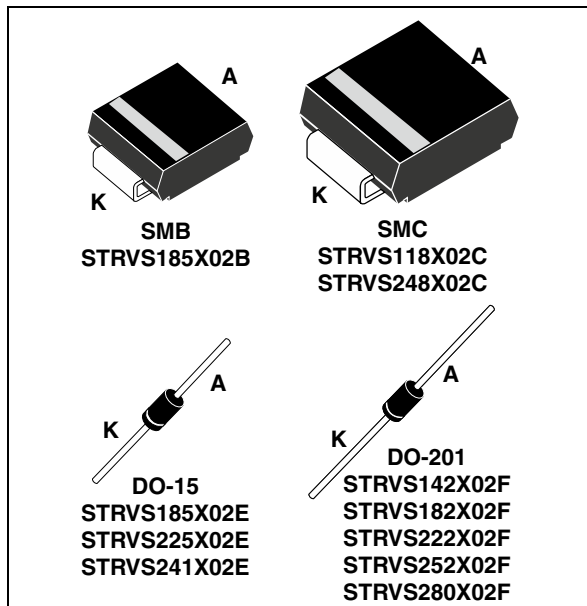

Features

- Clamping voltage characteristics defined at 25 °C, 85 °C and 125 °C
- Stand-off voltage range: from 85 V to 188 V
- Low leakage current: 0.2 μ A at 25 °C
- Maximum operating junction temperatures:
 - SMB and SMC: 150 °C
 - DO-15 and DO-201: 175 °C

Complies with the following standards:

- IEC 61000-4-2 level 4
 - \pm 15 kV (air discharge)
 - \pm 8 kV (contact discharge)
- IEC 61000-4-5 level 4
- MIL-STD-883, method 3015, class 3B:
 - 25 kV HBM (human body model)
- MIL-STD-750, method 2026 solderability
- EIA STD RS-481 and IEC 60286-3 packing (surface mount packages)

Applications

- MOSFET protection
- IGBT protection
- Auxiliary power supply

Description

The STRVSX series is a TVS family created to provide simple and effective solutions for designers working on circuits that require protection from repetitive overvoltages.

The STRVSX series is highly reliable and suits applications where the surge frequency makes the protected device temperature increase, for example, MOSFET protection in fly back configuration.

Additional support for designers using these devices is available in the STMicroelectronics application note AN4209: “Design methodology for repetitive voltage suppressors (RVS) in repetitive mode: STRVS”.

Table 1. Device summary

CPN	Clamping voltage $I_{PP} = 2 \text{ A (125 } ^\circ)$	Package
STRVS118X02C	118 V	SMC
STRVS142X02F	142 V	DO-201
STRVS182X02F	182 V	DO-201
STRVS185X02B	185 V	SMB
STRVS185X02E	185 V	DO-15
STRVS222X02F	222 V	DO-201
STRVS225X02E	225 V	DO-15
STRVS241X02E	241 V	DO-15
STRVS248X02C	248 V	SMC
STRVS252X02F	252 V	DO-201
STRVS280X02F	280 V	DO-201

1 Characteristics

Table 2. Absolute maximum ratings ($T_{amb} = 25\text{ °C}$)

Symbol	Parameter	Value	Unit
T_j	Operating junction temperature range (SMB and SMC)	-55 to 150	°C
	Operating junction temperature range (DO-15 and DO-201)	-55 to 175	°C
T_{stg}	Storage temperature range (SMB and SMC)	-65 to 150	°C
	Storage temperature range (DO-15 and DO-201)	-65 to 175	°C
T_L	Maximum lead temperature for soldering during 10 s (SMB and SMC)	260	°C
	Maximum lead temperature for soldering during 10 s at 5 mm from case (DO-15 and DO-201)	260	°C

Table 3. Thermal resistances

Symbol	Parameter	Value	Unit	
$R_{th(j-l)}$	Junction to leads	SMB	13	°C/W
		SMC	12	
		DO-15	35	
		DO-201	23	
$R_{th(j-a)}$	Junction to ambient ⁽¹⁾	SMB	185	
		SMC	150	
		DO-15	105	
		DO-201	100	

1. On printed circuit with recommended pad layout

Figure 1. Electrical characteristics - definitions

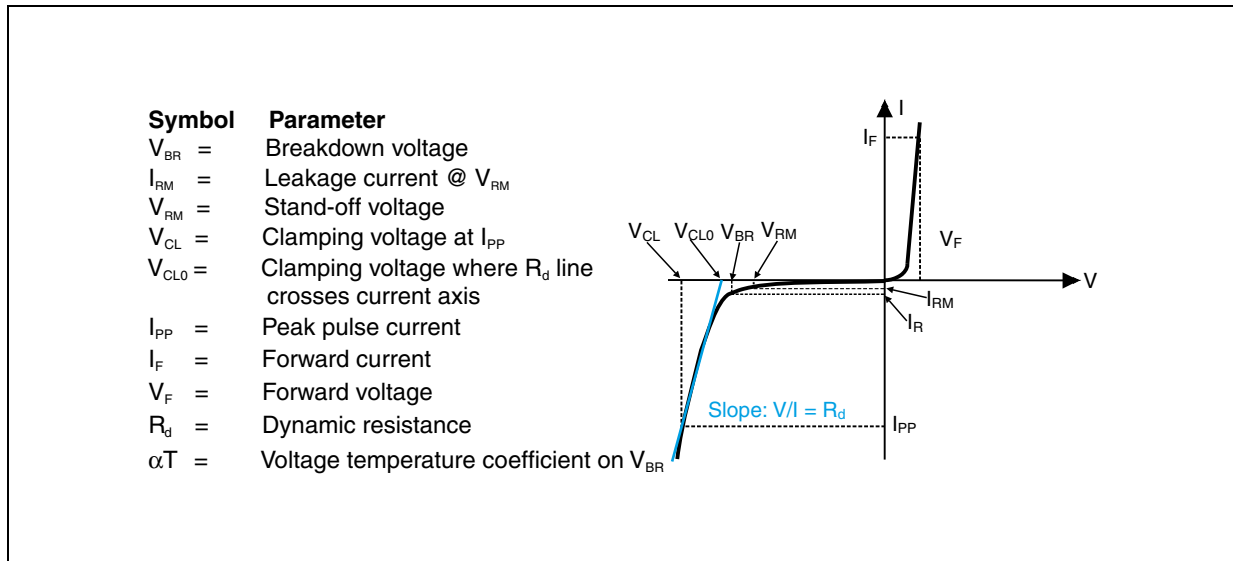

Table 4. Electrical characteristics - values

Order code	I _{RM} max @ V _{RM} (25 °C)		V _{BR} @ I _R ⁽¹⁾ (25 °C)		Values @ 125 °C (typ.)				αT	
			Min.	Max.	I _{PP}	V _{CL} @ I _{PP}	V _{CL0}	R _d ⁽²⁾	Max.	
	μA	V	V		mA	A	V	V	Ω	10 ⁻⁴ /°C
STRVS118X02C	0.2	85	95	105	1	2	118	116	1.0	10.6
STRVS142X02F	1	102	114	126	1	2	142	140	1.0	10.7
STRVS182X02F	1	128	143	158	1	2	182	177	2.5	10.8
STRVS185X02B/E	0.2	128	143	158	1	2	185	178	2.5	10.8
STRVS222X02F	1	154	171	189	1	2	222	213	4.5	10.8
STRVS225X02E	0.5	154	171	189	1	2	225	214	5.5	10.8
STRVS241X02E	0.5	171	190	210	1	2	241	234	3.5	10.8
STRVS248X02C	0.5	171	190	210	1	2	248	238	5.0	10.8
STRVS252X02F	1	171	190	210	1	2	252	239	6.5	10.8
STRVS280X02F	1	188	209	231	1	2	280	263	8.5	10.8

1. To calculate V_{BR} at a given junction temperature, use the following formula: V_{BR} @ T_j = V_{BR} @ 25 °C x (1 + αT x (T_j - 25))

2. R_d = (V_{CL} - V_{CL0})/I_{PP}

Figure 2. Clamping voltage versus peak pulse current - STRVS118X02C (typical values)

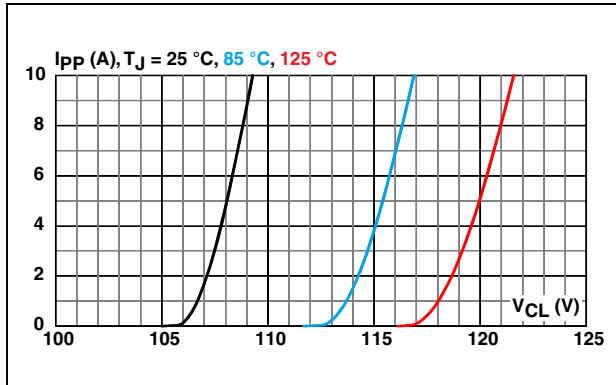

Figure 3. Clamping voltage versus peak pulse current - STRVS142X02F (typical values)

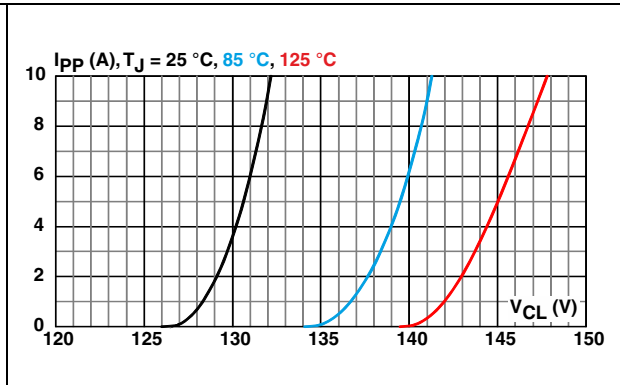

Figure 4. Clamping voltage versus peak pulse current - STRVS182X02F (typical values)

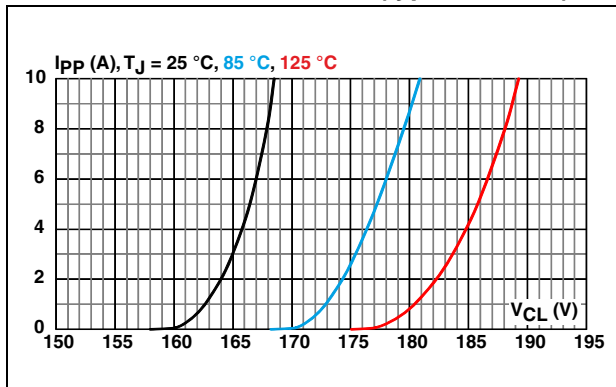

Figure 5. Clamping voltage versus peak pulse current - STRVS185X02B/E (typical values)

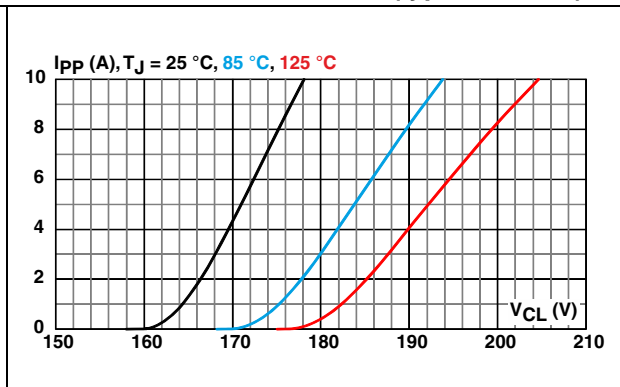

Figure 6. Clamping voltage versus peak pulse current - STRVS222X02F (typical values)

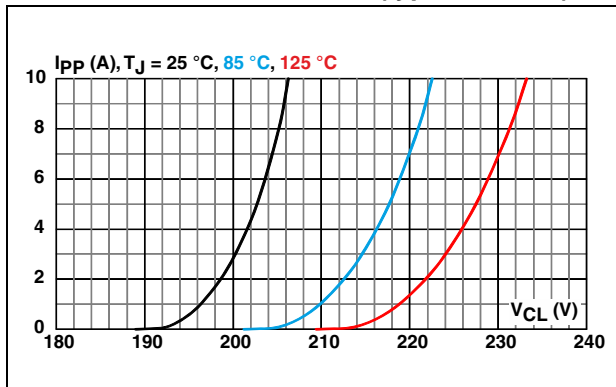

Figure 7. Clamping voltage versus peak pulse current - STRVS225X02E (typical values)

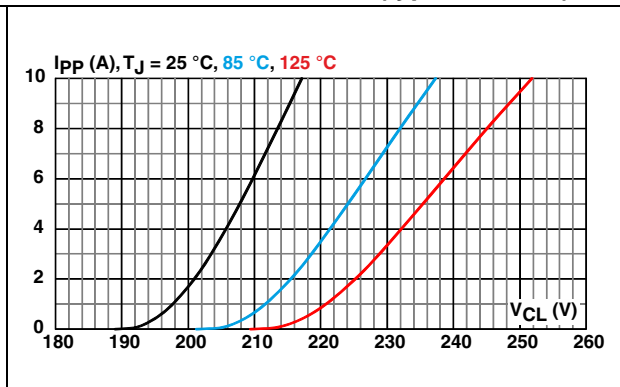

Figure 8. Clamping voltage versus peak pulse current - STRVS241X02E (typical values)

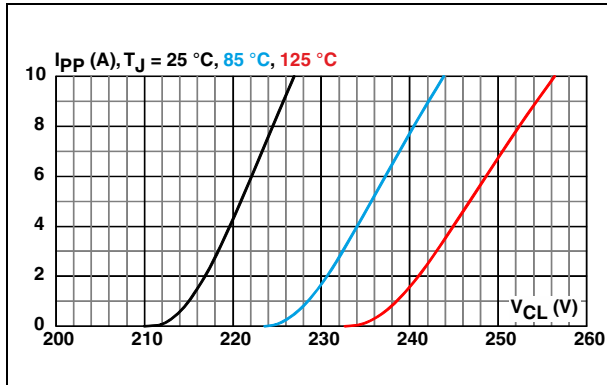

Figure 9. Clamping voltage versus peak pulse current - STRVS248X02C (typical values)

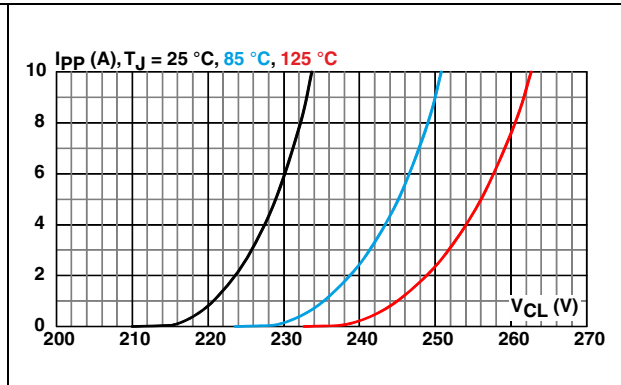

Figure 10. Clamping voltage versus peak pulse current - STRVS252X02F (typical values)

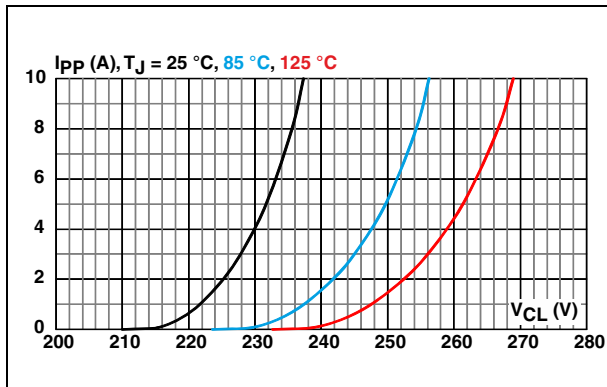

Figure 11. Clamping voltage versus peak pulse current - STRVS280X02F (typical values)

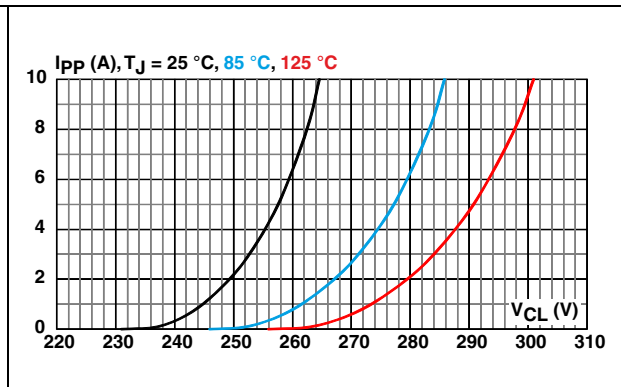

Figure 12. Leakage current versus junction temperature (typical values) STRVSxxxC

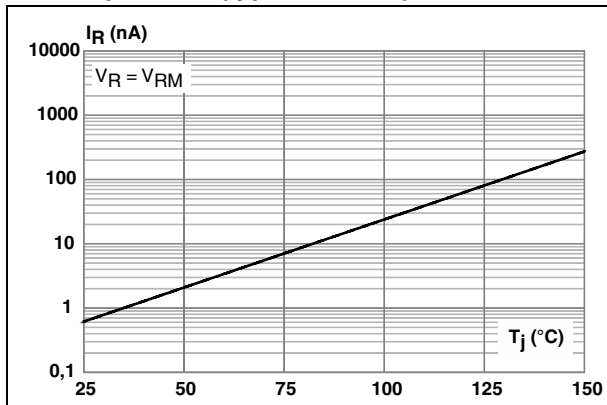

Figure 13. Leakage current versus junction temperature (typical values) STRVSxxxF

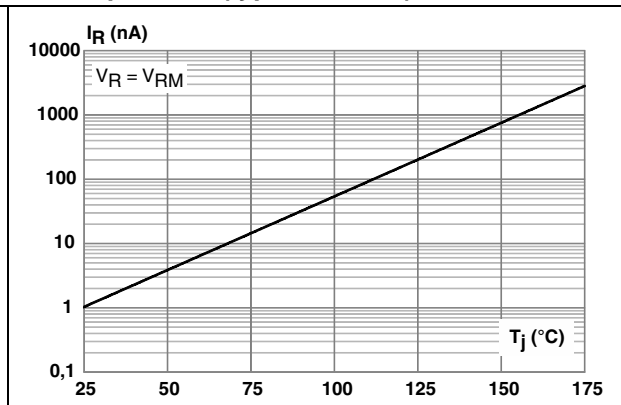

Figure 14. Leakage current versus junction temperature (typical values) STRVSxxxB

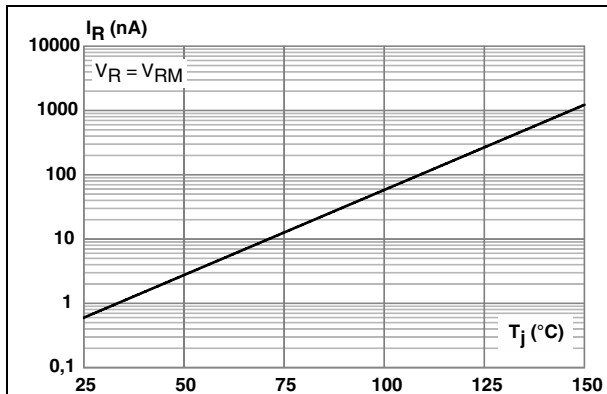

Figure 15. Leakage current versus junction temperature (typical values) STRVSxxxE

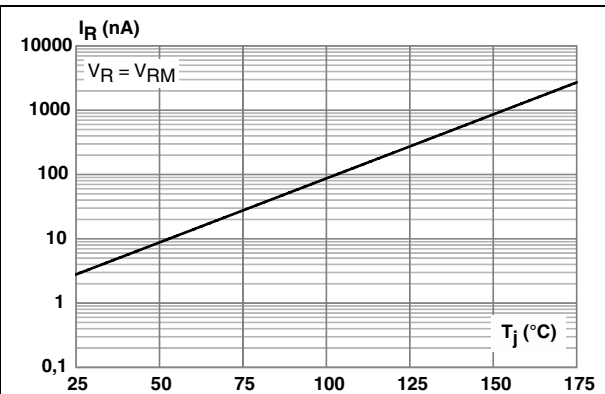

Figure 16. Thermal resistance junction to ambient versus copper surface of connections - SMB

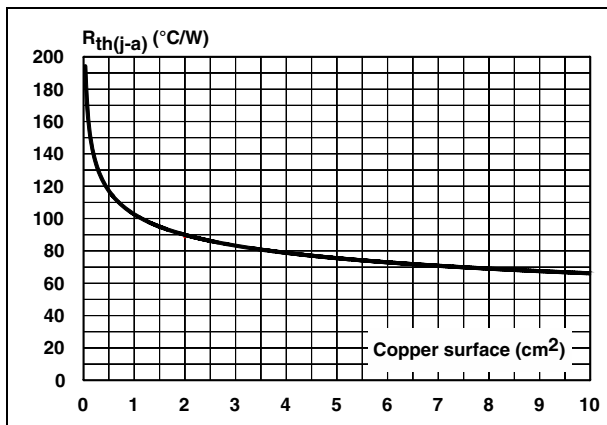

Figure 17. Thermal resistance junction to ambient versus copper surface of connections - SMC

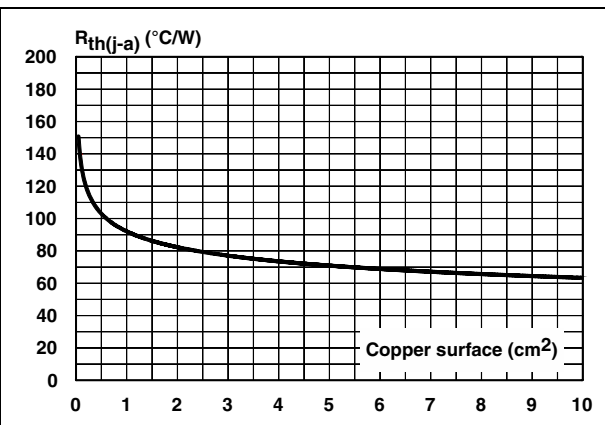

Figure 18. Thermal resistance junction to ambient versus copper surface of connections - DO-15

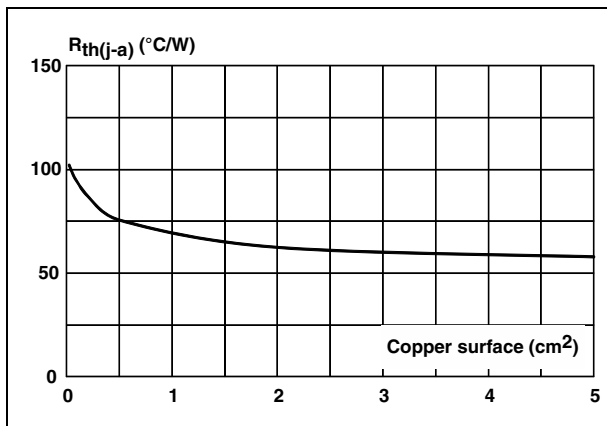
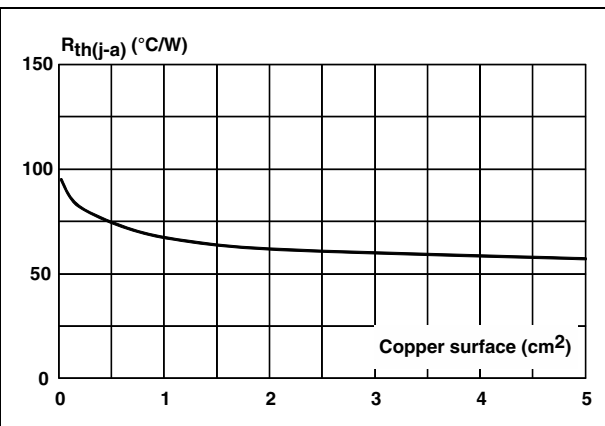

Figure 19. Thermal resistance junction to ambient versus copper surface of connections - DO-201



2 Package information

- Epoxy meets UL94, V0
- Lead-free package
- Polarity: band indicates cathode
- Terminals: solder plated, solderable as per MIL-STD-750, method 2026

In order to meet environmental requirements, ST offers these devices in different grades of ECOPACK[®] packages, depending on their level of environmental compliance. ECOPACK[®] specifications, grade definitions and product status are available at: www.st.com. ECOPACK[®] is an ST trademark.

Figure 20. SMB dimension definitions

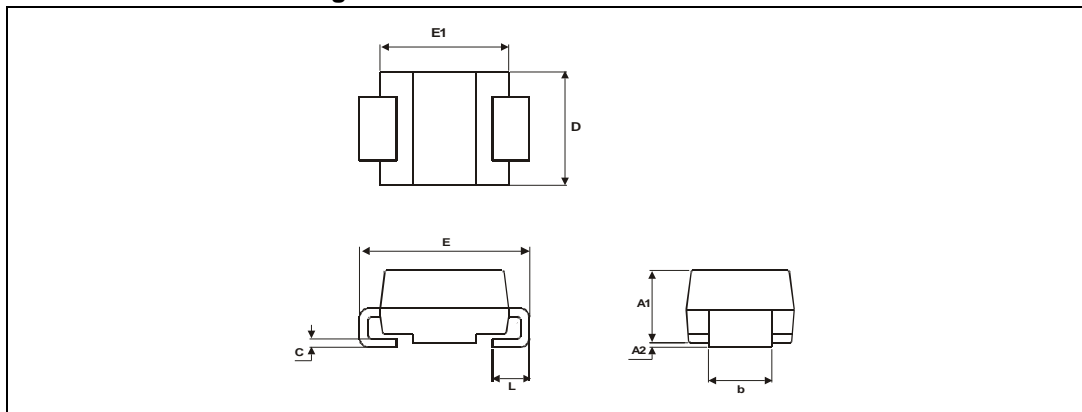

Table 5. SMB dimension values

Ref.	Dimensions			
	Millimeters		Inches	
	Min.	Max.	Min.	Max.
A1	1.90	2.45	0.075	0.096
A2	0.05	0.20	0.002	0.008
b	1.95	2.20	0.077	0.087
c	0.15	0.40	0.006	0.016
D	3.30	3.95	0.130	0.156
E	5.10	5.60	0.201	0.220
E1	4.05	4.60	0.159	0.181
L	0.75	1.50	0.030	0.059

Figure 21. SMB Footprint, dimensions in mm (inches)

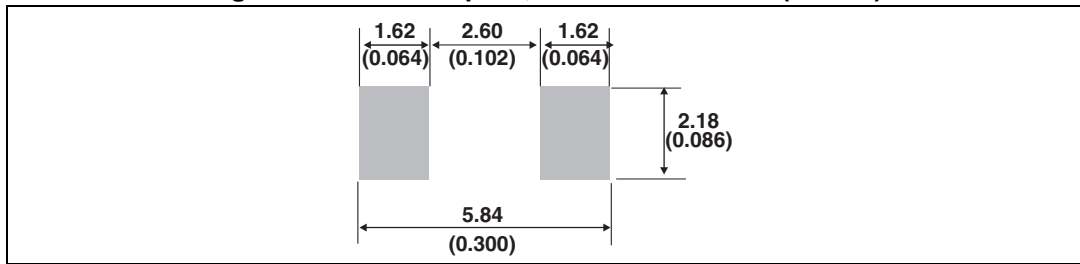

Figure 22. SMB marking layout

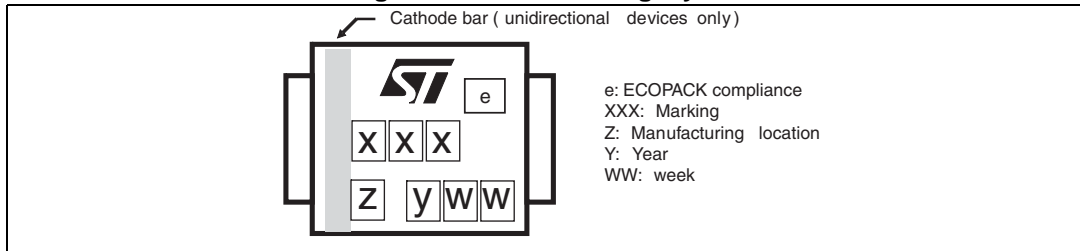

Figure 23. SMC dimension definitions

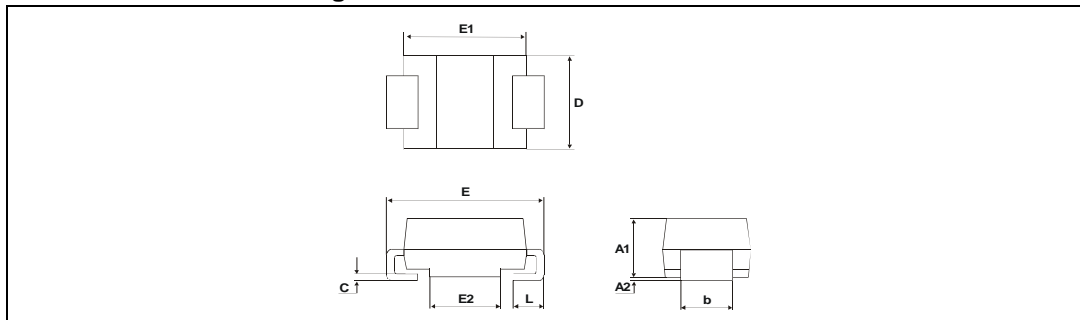

Table 6. SMC dimension values

Ref.	Dimensions			
	Millimeters		Inches	
	Min.	Max.	Min.	Max.
A1	1.90	2.45	0.075	0.096
A2	0.05	0.20	0.002	0.008
b ⁽¹⁾	2.90	3.20	0.114	0.126
c ⁽¹⁾	0.15	0.40	0.006	0.016
D	5.55	6.25	0.218	0.246
E	7.75	8.15	0.305	0.321
E1	6.60	7.15	0.260	0.281
E2	4.40	4.70	0.173	0.185
L	0.75	1.50	0.030	0.059

1. Dimensions b and c apply to plated leads

Figure 24. SMC footprint, dimensions in mm (inches)

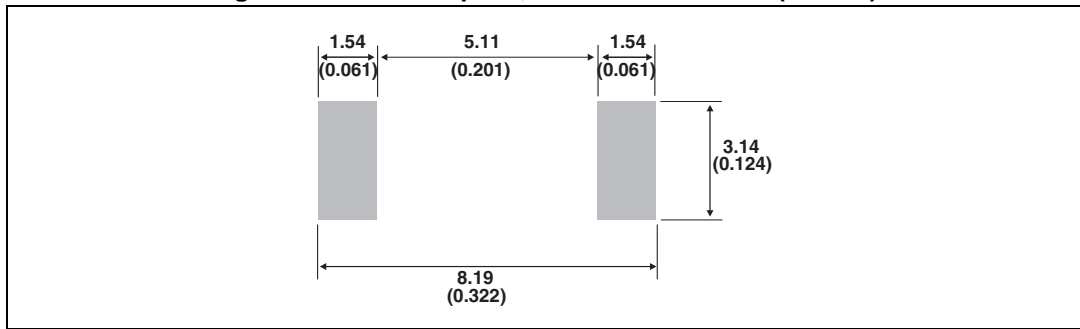

Figure 25. SMC marking layout

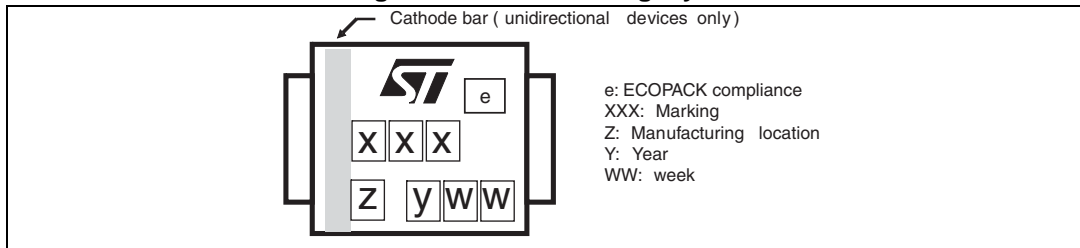

Figure 26. DO-15 dimension definitions

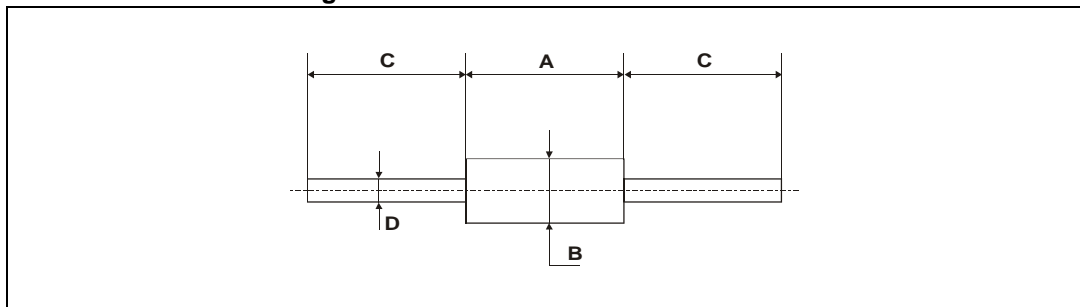

Table 7. DO-15 dimension values

Ref.	Dimensions			
	Millimeters		Inches	
	Min.	Max.	Min.	Max.
A	6.05	6.75	0.238	0.266
B	2.95	3.53	0.116	0.139
C	26	31	1.024	1.220
D	0.71	0.88	0.028	0.035

Figure 27. DO-201 dimension definitions

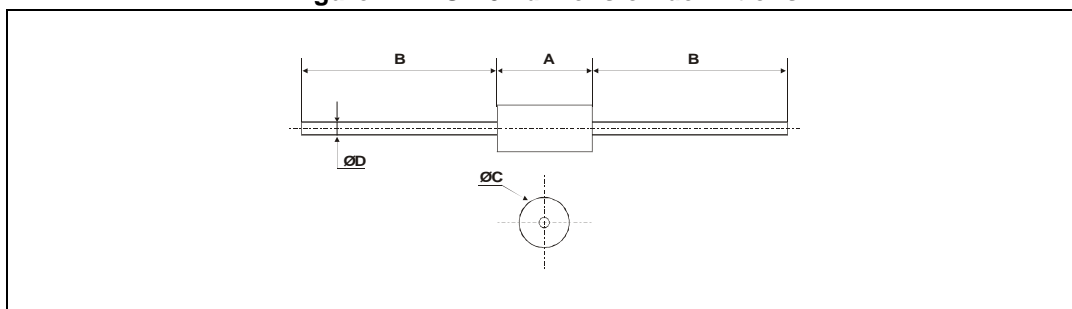

Table 8. DO-201 dimension values

Ref.	Dimensions			
	Millimeters		Inches	
	Min.	Max.	Min.	Max.
A	8.5	9.5	0.335	0.374
B	25.4		1	
Ø C	4.8	5.3	0.189	0.209
Ø D	0.96	1.06	0.038	0.042

3 Ordering information

Figure 28. Ordering information scheme

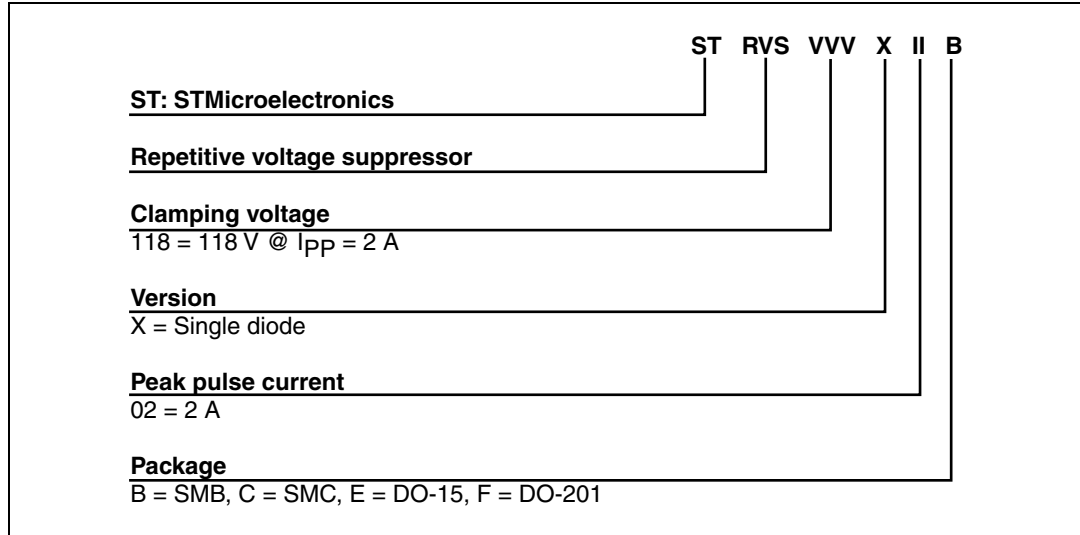

Table 9. Ordering information

Order code	Marking	Package	Weight	Base qty.	Delivery mode
STRVS118X02C	R118C	SMC	0.25 g	2500	Tape and reel
STRVS142X02F	R142F	DO-201	0.90 g	600	Ammopack
STRVS182X02F	R182F	DO-201	0.90 g	600	Ammopack
STRVS185X02B	R185B	SMB	0.12	2500	Tape and reel
STRVS185X02E	R185E	DO-15	0.40	1000	Ammopack
STRVS222X02F	R222F	DO-201	0.90 g	600	Ammopack
STRVS225X02E	R225E	DO-15	0.40	1000	Ammopack
STRVS241X02E	R241E	DO-15	0.40	1000	Ammopack
STRVS248X02C	R4248C	SMC	0.25 g	2500	Tape and reel
STRVS252X02F	R252F	DO-201	0.90 g	600	Ammopack
STRVS280X02F	R280F	DO-201	0.90 g	600	Ammopack

4 Revision history

Table 10. Document revision history

Date	Revision	Changes
05-Mar-2013	1	Initial release.
18-Apr-2013	2	Insertion of Table 1 .
15-Oct-2013	3	Updated Table 1 .

Please Read Carefully:

Information in this document is provided solely in connection with ST products. STMicroelectronics NV and its subsidiaries ("ST") reserve the right to make changes, corrections, modifications or improvements, to this document, and the products and services described herein at any time, without notice.

All ST products are sold pursuant to ST's terms and conditions of sale.

Purchasers are solely responsible for the choice, selection and use of the ST products and services described herein, and ST assumes no liability whatsoever relating to the choice, selection or use of the ST products and services described herein.

No license, express or implied, by estoppel or otherwise, to any intellectual property rights is granted under this document. If any part of this document refers to any third party products or services it shall not be deemed a license grant by ST for the use of such third party products or services, or any intellectual property contained therein or considered as a warranty covering the use in any manner whatsoever of such third party products or services or any intellectual property contained therein.

UNLESS OTHERWISE SET FORTH IN ST'S TERMS AND CONDITIONS OF SALE ST DISCLAIMS ANY EXPRESS OR IMPLIED WARRANTY WITH RESPECT TO THE USE AND/OR SALE OF ST PRODUCTS INCLUDING WITHOUT LIMITATION IMPLIED WARRANTIES OF MERCHANTABILITY, FITNESS FOR A PARTICULAR PURPOSE (AND THEIR EQUIVALENTS UNDER THE LAWS OF ANY JURISDICTION), OR INFRINGEMENT OF ANY PATENT, COPYRIGHT OR OTHER INTELLECTUAL PROPERTY RIGHT.

ST PRODUCTS ARE NOT DESIGNED OR AUTHORIZED FOR USE IN: (A) SAFETY CRITICAL APPLICATIONS SUCH AS LIFE SUPPORTING, ACTIVE IMPLANTED DEVICES OR SYSTEMS WITH PRODUCT FUNCTIONAL SAFETY REQUIREMENTS; (B) AERONAUTIC APPLICATIONS; (C) AUTOMOTIVE APPLICATIONS OR ENVIRONMENTS, AND/OR (D) AEROSPACE APPLICATIONS OR ENVIRONMENTS. WHERE ST PRODUCTS ARE NOT DESIGNED FOR SUCH USE, THE PURCHASER SHALL USE PRODUCTS AT PURCHASER'S SOLE RISK, EVEN IF ST HAS BEEN INFORMED IN WRITING OF SUCH USAGE, UNLESS A PRODUCT IS EXPRESSLY DESIGNATED BY ST AS BEING INTENDED FOR "AUTOMOTIVE, AUTOMOTIVE SAFETY OR MEDICAL" INDUSTRY DOMAINS ACCORDING TO ST PRODUCT DESIGN SPECIFICATIONS. PRODUCTS FORMALLY ESCC, QML OR JAN QUALIFIED ARE DEEMED SUITABLE FOR USE IN AEROSPACE BY THE CORRESPONDING GOVERNMENTAL AGENCY.

Resale of ST products with provisions different from the statements and/or technical features set forth in this document shall immediately void any warranty granted by ST for the ST product or service described herein and shall not create or extend in any manner whatsoever, any liability of ST.

ST and the ST logo are trademarks or registered trademarks of ST in various countries.

Information in this document supersedes and replaces all information previously supplied.

The ST logo is a registered trademark of STMicroelectronics. All other names are the property of their respective owners.

© 2013 STMicroelectronics - All rights reserved

STMicroelectronics group of companies

Australia - Belgium - Brazil - Canada - China - Czech Republic - Finland - France - Germany - Hong Kong - India - Israel - Italy - Japan - Malaysia - Malta - Morocco - Philippines - Singapore - Spain - Sweden - Switzerland - United Kingdom - United States of America

www.st.com

Looking for pricing, stock, or lifecycle information?

Click below to explore more details on WIN SOURCE:

- ⊖ [View STRVS248X02C on WIN SOURCE](#)
- ⊖ [STMicroelectronics Information](#)

Optimize Your Supply Chain with WIN SOURCE Solutions

- ✓ Global Sourcing Solution
- ✓ Obsolete Management
- ✓ Cost Control Management
- ✓ Shortage Management
- ✓ Alternative Solution
- ✓ Excess Inventory Management