



**THE DATASHEET OF
MAL215099001E3**



Aluminum Electrolytic Capacitors SMD (Chip), Very Low Z



LINKS TO ADDITIONAL RESOURCES

SPICE

Models

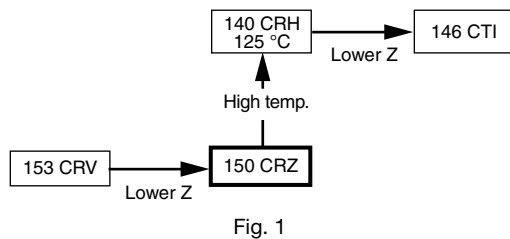

Fig. 1

QUICK REFERENCE DATA	
DESCRIPTION	VALUE
Nominal case sizes (L x W x H in mm)	8 x 8 x 10 to 18 x 18 x 21
Rated capacitance range, C_R	4.7 μ F to 10 000 μ F
Tolerance on C_R	± 20 %
Rated voltage range, U_R	6.3 V to 100 V
Category temperature range	
6.3 V to 63 V:	-55 °C to +105 °C
80 V to 100 V:	-40 °C to +105 °C
Endurance test at 105 °C	2000 h to 8000 h
Useful life at 105 °C	2500 h to 10 000 h
Useful life at 40 °C; 1.8 x I_R applied	125 000 h to 500 000 h
Shelf life at 0 V, 105 °C	1000 h
Based on sectional specification	IEC 60384-18 / CECC 32300
Climatic category IEC 60068	
6.3 V to 63 V:	55 / 105 / 56
80 V to 100 V:	40 / 105 / 56

FEATURES

- Extended useful life: up to 10 000 h at 105 °C for MAL215099...E3 parts
- Polarized aluminum electrolytic capacitors, non-solid electrolyte, self healing
- SMD-version with base plate, lead (Pb)-free reflow solderable
- Very low impedance, very high ripple current
- Charge and discharge proof, no peak current limitation
- Parts for advanced high temperature reflow soldering according to JEDEC® J-STD-020
- Vibration proof, 4-pin version and 6-pin version
- AEC-Q200 qualified
- High reliability
- Low ESR
- Material categorization: for definitions of compliance please see www.vishay.com/doc?99912

AUTOMOTIVE
GRADE



RoHS
COMPLIANT

APPLICATIONS

- SMD technology, for high temperature reflow soldering
- Industrial and professional applications
- Automotive, general industrial, telecom
- Smoothing, filtering, buffering

MARKING

- Rated capacitance (in μ F)
- Rated voltage (in V)
- Date code, in accordance with IEC 60062
- Black mark or “-” sign indicating the cathode (the anode is identified by bevelled edges)
- Code indicating group number (Z)

PACKAGING

Supplied in blister tape on reel

SELECTION CHART FOR C_R , U_R , AND RELEVANT NOMINAL CASE SIZES (L x W x H in mm)									
C_R (μF)	U_R (V)								
	6.3	10	16	25	35	50	63	80	100
4.7	→	→	→	→	→	→	→	→	10 x 10 x 10
10	→	→	→	→	→	→	→	→	10 x 10 x 10
22	→	→	→	→	→	→	→	→	10 x 10 x 10
33	→	→	→	→	→	→	8 x 8 x 10	→	10 x 10 x 10
47	→	→	→	→	→	→	8 x 8 x 10	10 x 10 x 10	10 x 10 x 12
	→	→	→	→	→	→	10 x 10 x 10		-
68	→	→	→	→	→	8 x 8 x 10	10 x 10 x 10	→	12.5 x 12.5 x 13
100	→	→	→	→	8 x 8 x 10	10 x 10 x 10	10 x 10 x 12	10 x 10 x 12	12.5 x 12.5 x 13
	→	→	→	→	→	→	10 x 10 x 14		-
150	→	→	→	8 x 8 x 10	→	→	12.5 x 12.5 x 13	12.5 x 12.5 x 13	12.5 x 12.5 x 16
220	→	→	8 x 8 x 10	8 x 8 x 10	10 x 10 x 10	10 x 10 x 12	12.5 x 12.5 x 16	12.5 x 12.5 x 16	16 x 16 x 16
	→	→	→	→	→	10 x 10 x 14			-
330	→	8 x 8 x 10	8 x 8 x 10	10 x 10 x 10	10 x 10 x 12	12.5 x 12.5 x 13	16 x 16 x 16	16 x 16 x 16	16 x 16 x 21
	→	→	→	→	10 x 10 x 14				18 x 18 x 16
470	8 x 8 x 10	8 x 8 x 10	10 x 10 x 10	10 x 10 x 12	12.5 x 12.5 x 13	→	16 x 16 x 21	16 x 16 x 21	18 x 18 x 21
	→	→	→	10 x 10 x 14					18 x 18 x 16
680	→	10 x 10 x 10	10 x 10 x 12	12.5 x 12.5 x 13	12.5 x 12.5 x 16	16 x 16 x 16	18 x 18 x 21	18 x 18 x 21	-
	→	→	10 x 10 x 14						-
1000	10 x 10 x 10	10 x 10 x 12	12.5 x 12.5 x 13	12.5 x 12.5 x 16	16 x 16 x 16	16 x 16 x 21	-	-	-
	→	10 x 10 x 14				18 x 18 x 16			-
1500	→	12.5 x 12.5 x 13	12.5 x 12.5 x 16	16 x 16 x 16	16 x 16 x 21	18 x 18 x 21	-	-	-
	→	→			18 x 18 x 16	-			
2200	12.5 x 12.5 x 13	12.5 x 12.5 x 16	16 x 16 x 16	16 x 16 x 21	18 x 18 x 21	-	-	-	-
	→	→		18 x 18 x 16	-				
3300	→	16 x 16 x 16	16 x 16 x 21	18 x 18 x 21	-	-	-	-	-
	→	→	18 x 18 x 16	-					
4700	16 x 16 x 16	16 x 16 x 21	18 x 18 x 21	-	-	-	-	-	-
	→	18 x 18 x 16	-	-					
6800	16 x 16 x 21	18 x 18 x 21	-	-	-	-	-	-	-
	18 x 18 x 16	-	-	-					
10 000	18 x 18 x 21	-	-	-	-	-	-	-	-

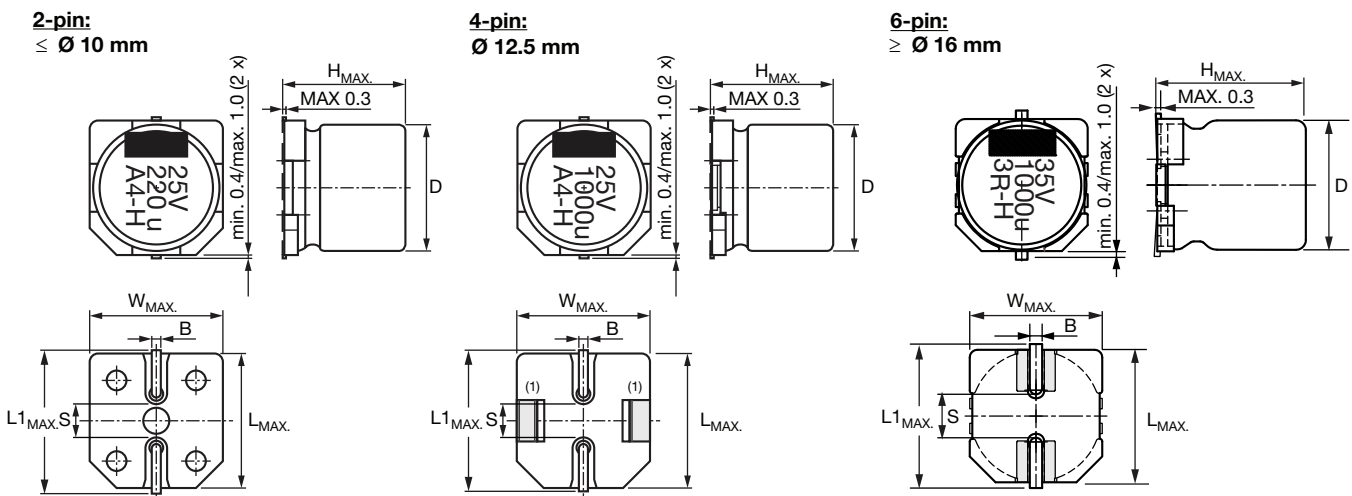

Fig. 2 - Dimensional outline

Note

(1) Additional dummy pins for mechanical stability, no electrical connection to pins or can



Fig. 3 - Coplanarity of pins

Table 1

DIMENSIONS in millimeters AND MASS									
NOMINAL CASE SIZE L x W x H	CASE CODE	L _{MAX.}	W _{MAX.}	H _{MAX.}	Ø D	B _{MAX.}	S	L1 _{MAX.}	MASS (g)
8 x 8 x 10	0810	8.5	8.5	10.5	8.0	1.0	2.2	10.2	≈ 1.0
10 x 10 x 10	1010	10.5	10.5	10.5	10.0	1.0	3.5	12.1	≈ 1.3
10 x 10 x 12	1012	10.5	10.5	12.5	10.0	1.0	3.5	12.1	≈ 1.5
10 x 10 x 14	1014	10.5	10.5	14.3	10.0	1.0	3.5	12.1	≈ 1.5
12.5 x 12.5 x 13	1213	12.9	12.9	14.0	12.5	1.3	3.6	14.9	≈ 2.6
12.5 x 12.5 x 16	1216	12.9	12.9	16.5	12.5	1.3	3.6	14.9	≈ 2.8
16 x 16 x 16	1616	16.6	16.6	17.5	16.0	1.3	6.5	18.6	≈ 5.5
16 x 16 x 21	1621	16.6	16.6	22.0	16.0	1.3	6.5	18.6	≈ 6.0
18 x 18 x 16	1816	19.0	19.0	17.5	18.0	1.3	6.5	21.0	≈ 8.0
18 x 18 x 21	1821	19.0	19.0	22.0	18.0	1.3	6.5	21.0	≈ 8.3

Table 2

TAPE AND REEL DIMENSIONS in millimeters, PACKAGING QUANTITIES						
NOMINAL CASE SIZE L x W x H	CASE CODE	PITCH P ₁	TAPE WIDTH W	TAPE THICKNESS T ₂	REEL DIAMETER	PACKAGING QUANTITY PER REEL
8 x 8 x 10	0810	16	24	11.6	380	500
10 x 10 x 10	1010	16	24	11.6	380	500
10 x 10 x 12	1012	16	24	12.8	330	250
10 x 10 x 14	1014	16	24	15.4	330	250
12.5 x 12.5 x 13	1213	20	24	16.2	380	250
12.5 x 12.5 x 16	1216	24	32	18.5	380	200
16 x 16 x 16	1616	28	44	18.9	380	150
16 x 16 x 21	1621	28	44	23.4	380	100
18 x 18 x 16	1816	32	44	18.9	380	125
18 x 18 x 21	1821	32	44	23.4	380	100

Note

- Detailed tape dimensions see section "PACKAGING"

MOUNTING

The capacitors are designed for automatic placement on to printed-circuit boards.

Optimum dimensions of soldering pads depend amongst others on soldering method, mounting accuracy, print layout and / or adjacent components. For recommended soldering pad dimensions, refer to Fig. 4 and Table 3.

SOLDERING

Soldering conditions are defined by the curve, temperature versus time, where the temperature is that measured on the component during processing.

For maximum conditions refer to Fig. 5 or Fig. 6.

Any temperature versus time curve which does not exceed the specified maximum curves may be applied.

As a general principle, temperature and duration shall be the **minimum** necessary required to ensure good soldering connections. However, the specified maximum curves should never be exceeded.

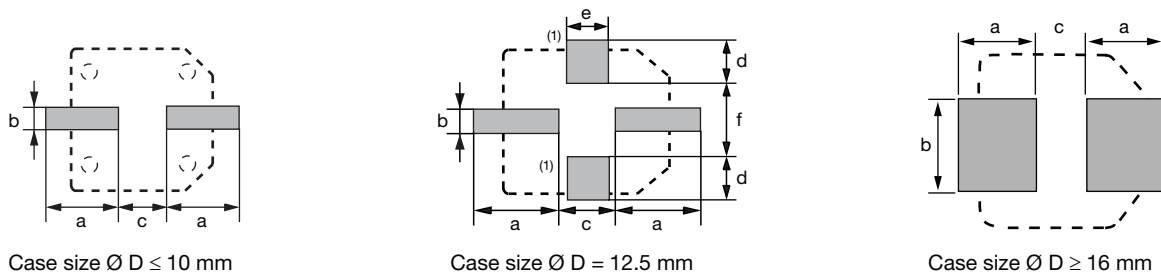

Fig. 4 - Recommended soldering pad dimensions

Note

(1) Additional solder pads, can be connected to GND or open

Table 3

RECOMMENDED SOLDERING PAD DIMENSIONS in millimeters						
CASE CODE	a	b	c	d	e	f
0810	4.4	2.5	3.0	-	-	-
1010	4.4	2.5	4.0	-	-	-
1012	4.4	2.5	4.0	-	-	-
1014	4.4	2.5	4.0	-	-	-
1213	6.3	2.5	4.0	4.2	5.0	5.6
1216	6.3	2.5	4.0	4.2	5.0	5.6
1616	7.8	9.6	4.7	-	-	-
1621	7.8	9.6	4.7	-	-	-
1816	8.8	9.6	4.7	-	-	-
1821	8.8	9.6	4.7	-	-	-

STANDARD SOLDERING PROFILE FOR LEAD (Pb)-FREE REFLOW PROCESS

Fig. 5 - Maximum temperature load during reflow soldering

Table 4

REFLOW SOLDERING CONDITIONS for MAL215097xxxE3		
PROFILE FEATURES	CASE CODE 0810 TO 1014	CASE CODE 1213 TO 1216
Max. time from 25 °C to T_{peak}	240 s	200 s
Max. ramp-up rate to 150 °C	3 K/s	3 K/s
Max. time from 150 °C to 200 °C (t_1)	150 s	120 s
Ramp up rate from 200 °C to T_{peak}	0.5 K/s to 3 K/s	0.5 K/s to 3 K/s
Max. time from 200 °C to 217 °C (t_2)	60 s	60 s
Max. time above $T_{Liquidus}$ (217 °C) (t_3)	90 s	60 s
Max. time above 230 °C (t_4)	40 s	30 s
Peak temperature T_{peak}	250 °C	240 °C
Max. time above T_{peak} minus 5 °C	5 s	10 s
Max. ramp-down rate from $T_{Liquidus}$	3 K/s to 6 K/s	3 K/s to 6 K/s

Notes

- Temperature measuring point on top of the case and on terminals
- Max. 2 runs with pause of min. 30 min in between

ADVANCED SOLDERING PROFILE FOR LEAD (Pb)-FREE REFLOW PROCESS ACCORDING TO JEDEC J-STD-020

Fig. 6 - Maximum temperature load during reflow soldering

Table 5

REFLOW SOLDERING CONDITIONS for MAL215099xxxE3			
PROFILE FEATURES	CASE CODE 1010 TO 1012	CASE CODE 1213 TO 1216	CASE CODE 1616 TO 1821
Max. time from 25 °C to T_{Peak}	300 s	300 s	300 s
Max. ramp-up rate to 150 °C	3 K/s	3 K/s	3 K/s
Max. time from 150 °C to 200 °C (t_1)	150 s	150 s	150 s
Max. time from 190 °C to 200 °C (t_2)	110 s	110 s	110 s
Ramp up rate from 200 °C to T_{Peak}	0.5 K/s to 3 K/s	0.5 K/s to 3 K/s	0.5 K/s to 3 K/s
Max. time above $T_{Liquidus}$ (217 °C) (t_3)	90 s	90 s	90 s
Max. time above 230 °C (t_4)	70 s	65 s	60 s
Peak temperature T_{Peak}	260 °C	250 °C	245 °C
Max. time above T_{Peak} minus 5 °C	40 s	30 s	30 s
Ramp-down rate from $T_{Liquidus}$	3 K/s to 6 K/s	3 K/s to 6 K/s	3 K/s to 6 K/s

Notes

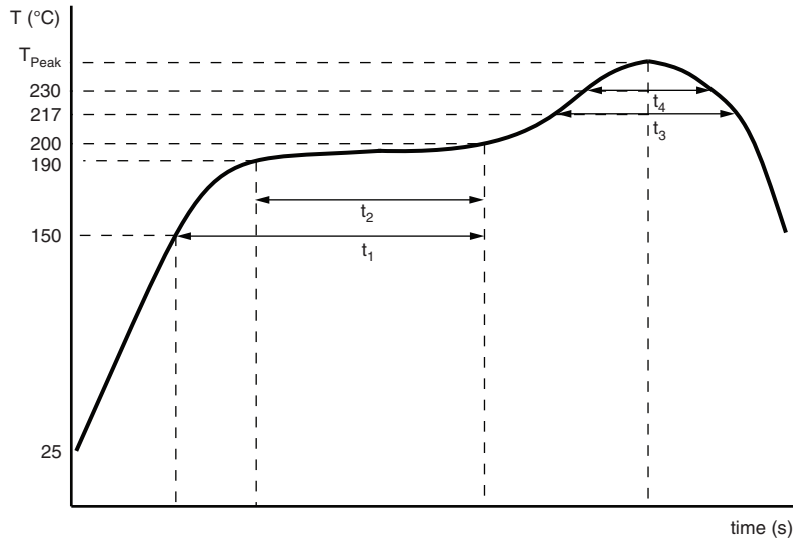
- Temperature measuring point on top of the case and on terminals
- Max. 2 runs with pause of min. 30 min in between



ELECTRICAL DATA	
SYMBOL	DESCRIPTION
C_R	Rated capacitance at 100 Hz, tolerance $\pm 20\%$
I_R	Rated RMS ripple current at 100 kHz, 105 °C
I_{L2}	Max. leakage current after 2 min at U_R
$\tan \delta$	Max. dissipation factor at 100 Hz
Z	Max. impedance at 100 kHz

ORDERING EXAMPLE

Electrolytic capacitor 150 CRZ series

470 μF / 35 V; $\pm 20\%$

Nominal case size: 12.5 mm x 12.5 mm x 13 mm; taped on reel

Ordering code: MAL215099012E3

Note

- Unless otherwise specified, all electrical values in Table 6 apply at $T_{amb} = 20\text{ °C}$, $P = 86\text{ kPa}$ to 106 kPa , $RH = 45\%$ to 75%

Table 6

ELECTRICAL DATA AND ORDERING INFORMATION										
U_R (V)	C_R (μF)	NOMINAL CASE SIZE L x W x H (mm)	I_R 105 °C 100 kHz (mA)	I_L 2 min (μA)	$\tan \delta$ 100 Hz	Z 100 kHz 20 °C (Ω)	Z 100 kHz -40 °C (Ω)	LIFE CODE ⁽³⁾	ORDERING CODE ⁽¹⁾ MAL2150...	ORDERING CODE ⁽²⁾ MAL2150...
6.3	470	8 x 8 x 10	435	30	0.24	0.250	2.00	L1	97311E3	-
	1000	10 x 10 x 10	670	63	0.24	0.130	1.10	L2	97301E3	99301E3
	2200	12.5 x 12.5 x 13	905	139	0.26	0.077	0.60	L3	97312E3	-
	2200	12.5 x 12.5 x 13	905	139	0.26	0.077	0.60	L4	-	99312E3
	4700	16 x 16 x 16	1350	296	0.28	0.050	0.40	L6	-	99313E3
	6800	16 x 16 x 21	1666	428	0.30	0.035	0.28	L6	-	99314E3
	6800	18 x 18 x 16	1400	428	0.32	0.050	0.40	L6	-	99315E3
	10 000	18 x 18 x 21	1756	630	0.34	0.035	0.28	L6	-	99316E3
10	330	8 x 8 x 10	435	33	0.20	0.250	2.00	L1	97411E3	-
	470	8 x 8 x 10	435	47	0.20	0.250	2.00	L1	97412E3	-
	680	10 x 10 x 10	670	68	0.20	0.130	1.10	L2	97401E3	99401E3
	1000	10 x 10 x 12	850	100	0.20	0.100	0.80	L2	-	99403E3
	1000	10 x 10 x 14	850	100	0.20	0.100	0.80	L2	97402E3	-
	1500	12.5 x 12.5 x 13	905	150	0.22	0.077	0.60	L3	97413E3	-
	1500	12.5 x 12.5 x 13	905	150	0.22	0.077	0.60	L4	-	99413E3
	2200	12.5 x 12.5 x 16	1007	220	0.22	0.060	0.48	L3	97414E3	-
	2200	12.5 x 12.5 x 16	1007	220	0.22	0.060	0.48	L5	-	99414E3
	3300	16 x 16 x 16	1350	330	0.24	0.050	0.40	L6	-	99415E3
	4700	16 x 16 x 21	1666	470	0.26	0.035	0.28	L6	-	99416E3
	4700	18 x 18 x 16	1400	470	0.26	0.050	0.40	L6	-	99417E3
	6800	18 x 18 x 21	1756	680	0.28	0.035	0.28	L6	-	99418E3
16	220	8 x 8 x 10	435	35	0.16	0.250	2.00	L1	97511E3	-
	330	8 x 8 x 10	435	53	0.16	0.250	2.00	L1	97512E3	-
	470	10 x 10 x 10	670	75	0.16	0.130	1.10	L2	97501E3	99501E3
	680	10 x 10 x 12	850	109	0.16	0.100	0.80	L2	-	99503E3
	680	10 x 10 x 14	850	109	0.16	0.100	0.80	L2	97502E3	-
	1000	12.5 x 12.5 x 13	905	160	0.18	0.077	0.60	L3	97513E3	-
	1000	12.5 x 12.5 x 13	905	160	0.18	0.077	0.60	L4	-	99513E3
	1500	12.5 x 12.5 x 16	1007	240	0.18	0.060	0.48	L3	97514E3	-
	1500	12.5 x 12.5 x 16	1007	240	0.18	0.060	0.48	L5	-	99514E3
	2200	16 x 16 x 16	1350	352	0.20	0.050	0.40	L6	-	99515E3
	3300	16 x 16 x 21	1666	528	0.22	0.035	0.28	L6	-	99516E3
	3300	18 x 18 x 16	1400	528	0.22	0.050	0.40	L6	-	99517E3
	4700	18 x 18 x 21	1756	752	0.26	0.035	0.28	L6	-	99518E3

Notes

- (1) Standard reflow soldering profile, see Fig. 5 and Table 4
- (2) Advanced reflow soldering profile, according to JEDEC J-STD-020, see Fig. 6 and Table 5
- (3) Determines the applicable row in the table "Endurance Test Duration and Useful Life"



ELECTRICAL DATA AND ORDERING INFORMATION										
U _R (V)	C _R (μF)	NOMINAL CASE SIZE L x W x H (mm)	I _R 105 °C 100 kHz (mA)	I _L 2 min (μA)	tan δ 100 Hz	Z 100 kHz 20 °C (Ω)	Z 100 kHz -40 °C (Ω)	LIFE CODE ⁽³⁾	ORDERING CODE ⁽¹⁾ MAL2150...	ORDERING CODE ⁽²⁾ MAL2150...
25	150	8 x 8 x 10	420	38	0.14	0.280	2.24	L1	97611E3	-
	220	8 x 8 x 10	420	55	0.14	0.280	2.24	L1	97612E3	-
	330	10 x 10 x 10	640	83	0.14	0.140	1.12	L2	97601E3	99601E3
	470	10 x 10 x 12	820	118	0.14	0.110	0.88	L2	-	99603E3
	470	10 x 10 x 14	820	118	0.14	0.110	0.88	L2	97602E3	-
	680	12.5 x 12.5 x 13	905	170	0.16	0.077	0.60	L3	97613E3	-
	680	12.5 x 12.5 x 13	905	170	0.16	0.077	0.60	L4	-	99613E3
	1000	12.5 x 12.5 x 16	1007	250	0.16	0.060	0.48	L3	97614E3	-
	1000	12.5 x 12.5 x 16	1007	250	0.16	0.060	0.48	L5	-	99614E3
	1500	16 x 16 x 16	1350	375	0.16	0.050	0.40	L6	-	99615E3
	2200	16 x 16 x 21	1666	550	0.18	0.035	0.28	L6	-	99616E3
	2200	18 x 18 x 16	1400	550	0.18	0.050	0.40	L6	-	99617E3
	3300	18 x 18 x 21	1756	825	0.20	0.035	0.28	L6	-	99618E3
35	100	8 x 8 x 10	405	35	0.12	0.300	2.40	L1	97011E3	-
	220	10 x 10 x 10	630	77	0.12	0.150	1.20	L2	97001E3	99001E3
	330	10 x 10 x 12	790	116	0.12	0.120	0.96	L2	-	99003E3
	330	10 x 10 x 14	790	116	0.12	0.120	0.96	L2	97002E3	-
	470	12.5 x 12.5 x 13	905	165	0.14	0.077	0.60	L3	97012E3	-
	470	12.5 x 12.5 x 13	905	165	0.14	0.077	0.60	L4	-	99012E3
	680	12.5 x 12.5 x 16	1007	238	0.14	0.060	0.48	L3	97013E3	-
	680	12.5 x 12.5 x 16	1007	238	0.14	0.060	0.48	L5	-	99013E3
	1000	16 x 16 x 16	1350	350	0.14	0.050	0.40	L6	-	99014E3
	1500	16 x 16 x 21	1666	525	0.14	0.035	0.28	L6	-	99015E3
	1500	18 x 18 x 16	1400	525	0.14	0.050	0.40	L6	-	99016E3
	2200	18 x 18 x 21	1756	770	0.16	0.035	0.28	L6	-	99017E3
	50	68	8 x 8 x 10	333	34	0.12	0.480	3.84	L1	97111E3
100		10 x 10 x 10	490	50	0.12	0.240	1.92	L2	97101E3	99101E3
220		10 x 10 x 12	620	110	0.12	0.190	1.52	L2	-	99103E3
220		10 x 10 x 14	620	110	0.12	0.190	1.52	L2	97102E3	-
330		12.5 x 12.5 x 13	690	165	0.12	0.130	1.04	L3	97112E3	-
330		12.5 x 12.5 x 13	690	165	0.12	0.130	1.04	L4	-	99112E3
680		16 x 16 x 16	1035	340	0.12	0.085	0.68	L6	-	99114E3
1000		16 x 16 x 21	1100	500	0.12	0.080	0.64	L6	-	99115E3
1000		18 x 18 x 16	1074	500	0.12	0.085	0.68	L6	-	99116E3
1500		18 x 18 x 21	1470	750	0.12	0.080	0.64	L6	-	99117E3
63		33	8 x 8 x 10	270	21	0.10	0.650	5.20	L1	97812E3
	47	8 x 8 x 10	270	30	0.10	0.650	5.20	L1	97811E3	-
	47	10 x 10 x 10	390	30	0.10	0.380	3.00	L2	97801E3	99801E3
	68	10 x 10 x 10	390	43	0.10	0.380	3.00	L2	97802E3	99802E3
	100	10 x 10 x 12	507	63	0.10	0.290	2.32	L2	-	99804E3
	100	10 x 10 x 14	507	63	0.10	0.290	2.32	L2	97803E3	-
	150	12.5 x 12.5 x 13	507	97	0.10	0.250	2.00	L3	97821E3	-
	150	12.5 x 12.5 x 13	507	97	0.10	0.250	2.00	L4	-	99821E3
	220	12.5 x 12.5 x 16	637	141	0.10	0.200	1.60	L3	97815E3	-
	220	12.5 x 12.5 x 16	637	141	0.10	0.200	1.60	L5	-	99815E3
	330	16 x 16 x 16	910	208	0.10	0.150	1.20	L6	-	99816E3
	470	16 x 16 x 21	987	296	0.10	0.120	0.96	L6	-	99817E3
	470	18 x 18 x 16	944	296	0.10	0.150	1.20	L6	-	99818E3
	680	18 x 18 x 21	1160	428	0.10	0.120	0.96	L6	-	99819E3

Notes

- (1) Standard reflow soldering profile, see Fig. 5 and Table 4
- (2) Advanced reflow soldering profile, according to JEDEC J-STD-020, see Fig. 6 and Table 5
- (3) Determines the applicable row in the table "Endurance Test Duration and Useful Life"



ELECTRICAL DATA AND ORDERING INFORMATION										
U _R (V)	C _R (μF)	NOMINAL CASE SIZE L x W x H (mm)	I _R 105 °C 100 kHz (mA)	I _L 2 min (μA)	tan δ 100 Hz	Z 100 kHz 20 °C (Ω)	Z 100 kHz -40 °C (Ω)	LIFE CODE ⁽³⁾	ORDERING CODE ⁽¹⁾ MAL2150...	ORDERING CODE ⁽²⁾ MAL2150...
80	47	10 x 10 x 10	240	38	0.10	0.800	6.40	L2	97701E3	99701E3
	100	10 x 10 x 12	300	80	0.10	0.620	4.96	L2	-	99702E3
	150	12.5 x 12.5 x 13	670	120	0.10	0.350	2.80	L3	-	99703E3
	220	12.5 x 12.5 x 16	750	176	0.10	0.250	2.00	L3	-	99704E3
	330	16 x 16 x 16	1000	264	0.10	0.180	1.44	L3	-	99705E3
	470	16 x 16 x 21	1400	376	0.10	0.120	0.96	L3	-	99706E3
	470	18 x 18 x 16	1050	376	0.10	0.160	1.28	L3	-	99707E3
	680	18 x 18 x 21	1450	544	0.10	0.110	0.88	L3	-	99708E3
100	4.7	10 x 10 x 10	210	5	0.10	0.800	6.40	L2	97901E3	-
	10	10 x 10 x 10	240	10	0.10	0.800	6.40	L2	97902E3	99902E3
	22	10 x 10 x 10	240	22	0.10	0.800	6.40	L2	97903E3	99903E3
	33	10 x 10 x 10	250	33	0.10	0.800	6.40	L2	97904E3	99904E3
	47	10 x 10 x 12	270	47	0.10	0.620	4.96	L2	-	99905E3
	68	12.5 x 12.5 x 13	660	68	0.10	0.350	2.80	L3	-	99906E3
	100	12.5 x 12.5 x 13	660	100	0.10	0.350	2.80	L3	-	99907E3
	150	12.5 x 12.5 x 16	750	150	0.10	0.250	2.00	L3	-	99908E3
	220	16 x 16 x 16	1000	220	0.10	0.180	1.44	L3	-	99909E3
	330	16 x 16 x 21	1400	330	0.10	0.120	0.96	L3	-	99911E3
	330	18 x 18 x 16	1050	330	0.10	0.160	1.28	L3	-	99912E3
	470	18 x 18 x 21	1450	470	0.10	0.110	0.80	L3	-	99913E3

Notes

- (1) Standard reflow soldering profile, see Fig. 5 and Table 4
- (2) Advanced reflow soldering profile, according to JEDEC J-STD-020, see Fig. 6 and Table 5
- (3) Determines the applicable row in the table "Endurance Test Duration and Useful Life"

Table 7

ADDITIONAL ELECTRICAL DATA		
PARAMETER	CONDITIONS	VALUE
Voltage		
Surge voltage for short periods	IEC 60384-18, subclause 4.14	$U_s \leq 1.1 \times U_R$
Reverse voltage for short periods	IEC 60384-18, subclause 4.16	$U_{rev} \leq 1 V$
Current		
Leakage current	After 2 min at U _R	$I_{L2} \leq 0.01 \times C_R \times U_R$
Inductance		
Equivalent series inductance (ESL)	Ø D = 8 mm	Typ. 6 nH
	Ø D = 10 mm	Typ. 8 nH
	Ø D ≥ 12.5 mm	Typ. 11 nH
Resistance		
Equivalent series resistance (ESR) at 100 Hz	Calculated from tan δ _{max.} and C _R (see Table 6)	$ESR = \tan \delta / 2\pi f C_R$

CAPACITANCE

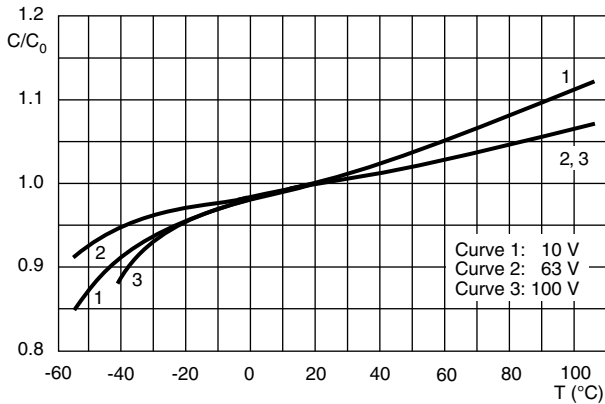

C_0 = Capacitance at 20 °C, 100 Hz

Fig. 7 - Typical multiplier of capacitance as a function of temperature at 100 Hz

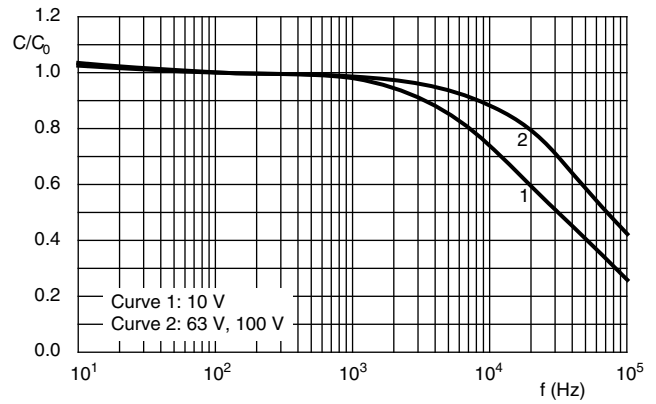

C_0 = Typical capacitance at 20 °C, 100 Hz

Fig. 8 - Typical multiplier of capacitance as a function of frequency at 20 °C

EQUIVALENT SERIES RESISTANCE (ESR)



ESR_0 = Typical ESR at 20 °C, 100 Hz

Fig. 9 - Typical multiplier of ESR as a function of temperature at 100 Hz

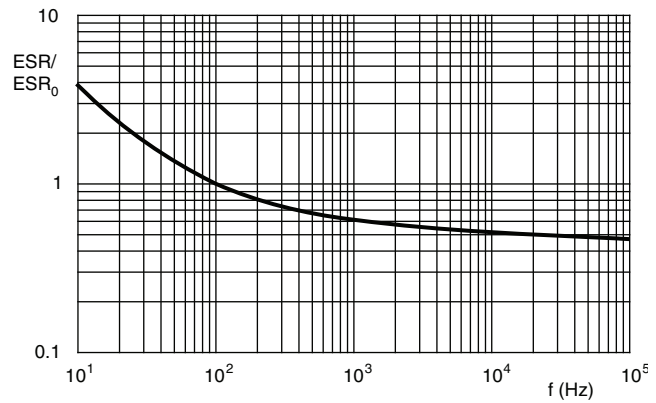

ESR_0 = Typical ESR at 20 °C, 100 Hz

Fig. 10 - Typical multiplier ESR as a function of frequency at 20 °C

DISSIPATION FACTOR (tan δ)



$\tan \delta_0$ = Typical $\tan \delta$ at 20 °C, 100 Hz

Fig. 11 - Typical multiplier of dissipation factor $\tan \delta$ as a function of temperature at 20 °C at 100 Hz

IMPEDANCE (Z)

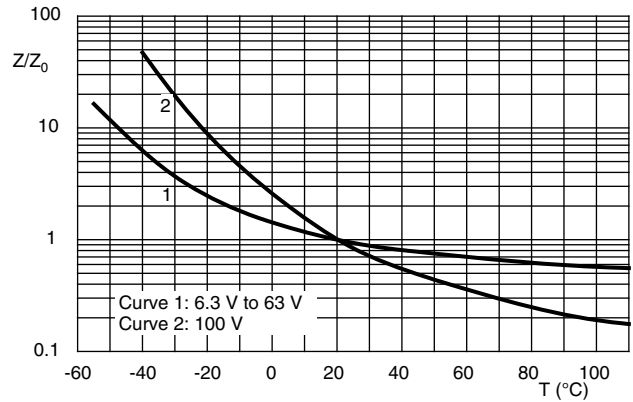

Z_0 = Typical impedance Z at 20 °C, 100 kHz

Fig. 12 - Typical multiplier of impedance Z as a function of temperature at 100 kHz

IMPEDANCE (Z)

Fig. 13 - Typical impedance Z as a function of frequency at 20 °C

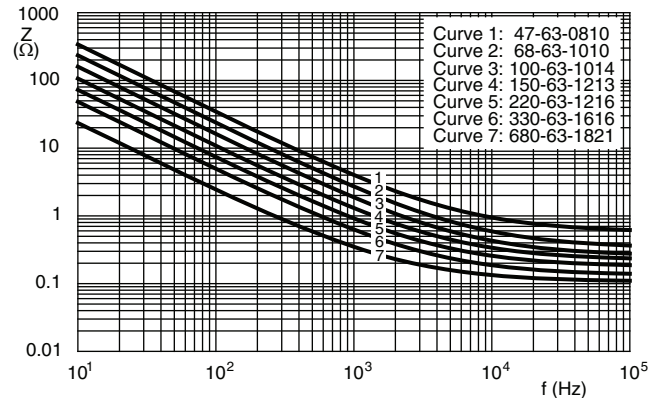

Fig. 14 - Typical impedance Z as a function of frequency at 20 °C

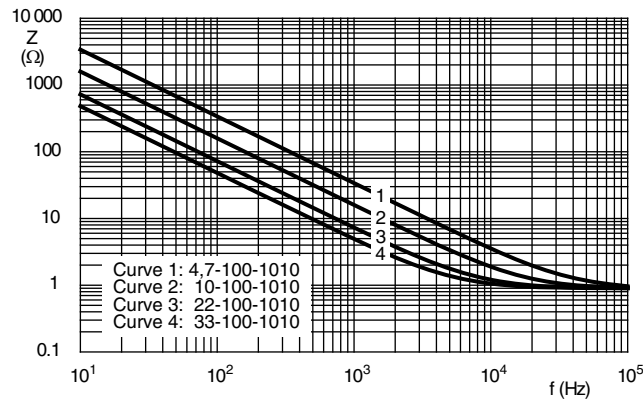

Fig. 15 - Typical impedance Z as a function of frequency at 20 °C

RIPPLE CURRENT AND USEFUL LIFE

Table 8

ENDURANCE TEST DURATION AND USEFUL LIFE			
LIFE CODE	ENDURANCE AT 105 °C (h)	USEFUL LIFE AT 105 °C (h)	USEFUL LIFE AT 40 °C 1.8 x I _R APPLIED (h)
L1	2000	2500	125 000
L2	2000	3000	150 000
L3	3000	5000	250 000
L4	5000	6000	300 000
L5	6500	7500	375 000
L6	8000	10 000	500 000

Note

- Multiplier of useful life code: CCC206



Fig. 16 - Multiplier of useful life as a function of ambient temperature and ripple current load

Table 9

MULTIPLIER OF RIPPLE CURRENT (I_R) AS A FUNCTION OF FREQUENCY							
V_R (V)	FREQUENCY (Hz)						
	100	300	1000	3000	10 000	30 000	100 000
	I_R MULTIPLIER						
6.3	0.70	0.80	0.85	0.93	0.95	0.97	1.00
10	0.70	0.80	0.85	0.93	0.95	0.97	1.00
16	0.70	0.80	0.85	0.93	0.95	0.97	1.00
25	0.70	0.80	0.85	0.93	0.95	0.97	1.00
35	0.65	0.80	0.85	0.93	0.95	0.97	1.00
50	0.60	0.75	0.85	0.93	0.95	0.97	1.00
63	0.60	0.75	0.85	0.93	0.95	0.97	1.00
80	0.60	0.75	0.85	0.93	0.95	0.97	1.00
100	0.60	0.75	0.85	0.93	0.95	0.97	1.00



Table 10

TEST PROCEDURES AND REQUIREMENTS			
TEST		PROCEDURE (quick reference)	REQUIREMENTS
NAME OF TEST	REFERENCE		
Mounting	IEC 60384-18, subclause 4.3	Shall be performed prior to tests mentioned below; reflow soldering; for maximum temperature load refer to chapter "Mounting"	$\Delta C/C: \pm 5 \%$ $\tan \delta \leq \text{spec. limit}$ $I_{L2} \leq \text{spec. limit}$
Endurance	IEC 60384-18 / CECC32300, subclause 4.15	$T_{amb} = 105 \text{ }^\circ\text{C}$; U_R applied; for test duration see Table 8	$U_R = 6.3 \text{ V}$; $\Delta C/C: \pm 25 \%$ $U_R \geq 10 \text{ V}$; $\Delta C/C: \pm 20 \%$ $\tan \delta \leq 2 \times \text{spec. limit}$ $I_{L2} \leq \text{spec. limit}$
Useful life	CECC 30301, subclause 1.8.1	$T_{amb} = 105 \text{ }^\circ\text{C}$; U_R and I_R applied; for test duration see Table 8	$\Delta C/C: \pm 30 \%$ $\tan \delta \leq 3 \times \text{spec. limit}$ $I_{L2} \leq \text{spec. limit}$ no short or open circuit total failure percentage: $\leq 1 \%$
Shelf life (storage at high temperature)	IEC 60384-18 / CECC32300, subclause 4.17	$T_{amb} = 105 \text{ }^\circ\text{C}$; no voltage applied; 1000 h after test: U_R to be applied for 30 min, 24 h to 48 h before measurement	For requirements see "Endurance test" above

Statements about product lifetime are based on calculations and internal testing. They should only be interpreted as estimations. Also due to external factors, the lifetime in the field application may deviate from the calculated lifetime. In general, nothing stated herein shall be construed as a guarantee of durability.



Disclaimer

ALL PRODUCT, PRODUCT SPECIFICATIONS AND DATA ARE SUBJECT TO CHANGE WITHOUT NOTICE TO IMPROVE RELIABILITY, FUNCTION OR DESIGN OR OTHERWISE.

Vishay Intertechnology, Inc., its affiliates, agents, and employees, and all persons acting on its or their behalf (collectively, "Vishay"), disclaim any and all liability for any errors, inaccuracies or incompleteness contained in any datasheet or in any other disclosure relating to any product.

Vishay makes no warranty, representation or guarantee regarding the suitability of the products for any particular purpose or the continuing production of any product. To the maximum extent permitted by applicable law, Vishay disclaims (i) any and all liability arising out of the application or use of any product, (ii) any and all liability, including without limitation special, consequential or incidental damages, and (iii) any and all implied warranties, including warranties of fitness for particular purpose, non-infringement and merchantability.

Statements regarding the suitability of products for certain types of applications are based on Vishay's knowledge of typical requirements that are often placed on Vishay products in generic applications. Such statements are not binding statements about the suitability of products for a particular application. It is the customer's responsibility to validate that a particular product with the properties described in the product specification is suitable for use in a particular application. Parameters provided in datasheets and / or specifications may vary in different applications and performance may vary over time. All operating parameters, including typical parameters, must be validated for each customer application by the customer's technical experts. Product specifications do not expand or otherwise modify Vishay's terms and conditions of purchase, including but not limited to the warranty expressed therein.

Hyperlinks included in this datasheet may direct users to third-party websites. These links are provided as a convenience and for informational purposes only. Inclusion of these hyperlinks does not constitute an endorsement or an approval by Vishay of any of the products, services or opinions of the corporation, organization or individual associated with the third-party website. Vishay disclaims any and all liability and bears no responsibility for the accuracy, legality or content of the third-party website or for that of subsequent links.

Except as expressly indicated in writing, Vishay products are not designed for use in medical, life-saving, or life-sustaining applications or for any other application in which the failure of the Vishay product could result in personal injury or death. Customers using or selling Vishay products not expressly indicated for use in such applications do so at their own risk. Please contact authorized Vishay personnel to obtain written terms and conditions regarding products designed for such applications.

No license, express or implied, by estoppel or otherwise, to any intellectual property rights is granted by this document or by any conduct of Vishay. Product names and markings noted herein may be trademarks of their respective owners.

Looking for pricing, stock, or lifecycle information?

Click below to explore more details on WIN SOURCE:

 [View MAL215099001E3 on WIN SOURCE](#)

 [Vishay Information](#)

Optimize Your Supply Chain with WIN SOURCE Solutions

-  Global Sourcing Solution
-  Obsolete Management
-  Cost Control Management
-  Shortage Management
-  Alternative Solution
-  Excess Inventory Management