



# THE DATASHEET OF OPB733TR



# Reflective Object Sensor



## Type OPB733TR

### Features:

- Unfocused for sensing diffuse surfaces
- Uses lensed devices for collimation of light beam
- Low-cost plastic housing
- Compact surface mount package 0.300" x 0.160" x 0.114" [7.6mmx4.1mmx2.9mm]
- Typical peak emission wavelength 890nm
- Reduced visible ambient light sensitivity
- Optimal operating distance range 0.4" [10.2mm] to 1.0" [25.4mm]



### Description:

The **OPB733TR** consists of an 890nm, Infrared Light Emitting Diode (LED) and an NPN silicon Phototransistor, which are mounted "side-by-side" on parallel axes in a miniature surface mount grey plastic housing. The Phototransistor is molded in a grey epoxy package, which minimizes visible ambient light sensitivity. The phototransistor responds to radiation from the LED when a reflective object passes within its field of view. This unfocused reflective object sensor is ideal for non-contact detection of materials such as paper, labels, white plastic and many other reflective materials.

The OPB733TR sensors are packaged in 16mm tape on 7" [178mm] diameter reels, 500 pcs per reel. Tape and Reel package compatible with most automatic placement equipment.

Custom electrical, PCB assembly, wire and connectors are available. Contact your local OPTEK authorized representative or OPTEK for more information.

### Applications:

- Assembly line automation
- ATM (Card Reader, Receipt Dispenser)
- Auto-dispense equipment
- Amusement equipment
- End-of-travel sensor
- Door sensor
- Edge detection
- Paper jam detection
- Mark detection
- Counters and sorters
- Proximity sensing
- Medical equipment
- Machine safety

Ordering Information	
Part Number	Description
OPB733TR	SMD Reflective Object Sensor

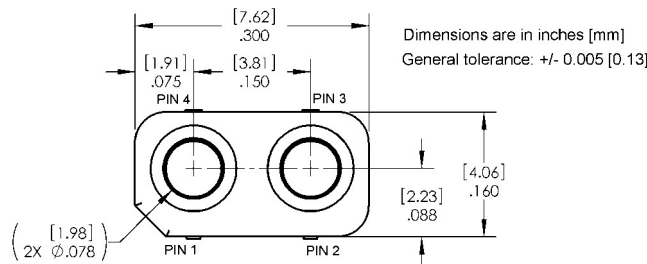

### OPB733TR

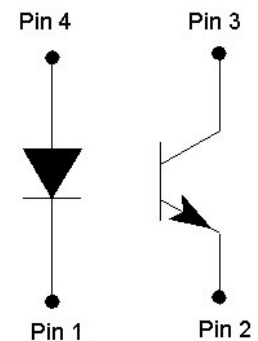

Pin #	Function
1	Cathode
2	Emitter
3	Collector
4	Anode

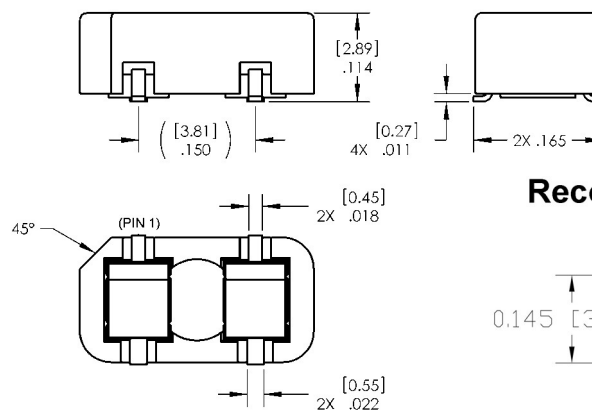

### Recommended Solder Pad

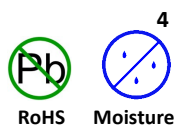
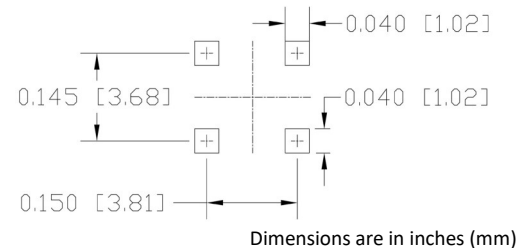

#### General Note

TT Electronics reserves the right to make changes in product specification without notice or liability. All information is subject to TT Electronics' own data and is considered accurate at time of going to print.

TT Electronics | OPTEK Technology  
2900 E. Plano Pkwy, Plano, TX 75074 | Ph: +1 972 323 2200  
www.ttelectronics.com | sensors@ttelectronics.com

# Reflective Object Sensor

Type OPB733TR



## Electrical Specifications

**Absolute Maximum Ratings** ( $T_A = 25^\circ\text{C}$  unless otherwise noted)

Storage and Operating Temperature Range	-25° C to +85° C
Soldering Temperature. (see reflow solder temperature profile figure)	260° C
<b>Input LED</b>	
Forward DC Current	50 mA
Peak Forward Current (1 $\mu\text{s}$ pulse width, 300 pps)	1 A
Reverse DC Voltage	5 V
Power Dissipation <sup>(2)</sup>	130 mW
<b>Output Phototransistor</b>	
Collector-Emitter Voltage	30 V
Emitter-Collector Voltage	5 V
Collector DC Current	20 mA
Power Dissipation <sup>(3)</sup>	75 mW

**Electrical Characteristics** ( $T_A = 25^\circ\text{C}$  unless otherwise noted)

SYMBOL	PARAMETER	MIN	TYP	MAX	UNITS	TEST CONDITIONS
<b>Input IR LED (see OP271 for additional information)</b>						
$V_F$	Forward Voltage	-	-	1.7	V	$I_F = 20\text{ mA}$
$I_R$	Reverse Current	-	-	10	$\mu\text{A}$	$V_R = 5\text{ V}$
$\theta_{HP}$	Emission angle at half power points	-	25	-	Degree	$I_F = 20\text{ mA}$
$\lambda_P$	Peak Emission Wavelength	-	890	-	nm	$I_F = 10\text{ mA}$
<b>Output Phototransistor (see OP571 for additional information)</b>						
$V_{(BR)CEO}$	Collector Emitter Breakdown Voltage	30	-	-	V	$I_C = 100\ \mu\text{A}$
$V_{(BR)ECO}$	Emitter Collector Breakdown Voltage	5	-	-	v	$I_E = 100\ \mu\text{A}$
$I_{CEO}$	Collector Dark Current	-	-	100	nA	$V_{CE} = 10\text{ V}, I_F = 0$
$T_r$	Rise Time	-	15	-	$\mu\text{s}$	$V_{CE} = 5\text{ Volts}^{(3)}$ $I_C = 1\text{ mA}$
$T_f$	Fall Time	-	15	-	$\mu\text{s}$	$R_L = 1\text{K}\Omega$
<b>Coupled Characteristics</b>						
$V_{CE(SAT)}$	Collector Emitter Saturation Voltage	-	-	0.4	V	$d = 0.5'' (12.7\text{ mm})^{(1)(2)}$ $I_C = 50\ \mu\text{A}, I_F = 20\text{ mA}$
$I_{C(ON)}$	On-State Collector Current	0.1	-	-	mA	$d = 0.5'' (12.7\text{ mm})^{(1)(2)}$ $I_F = 20\text{ mA}, V_{CE} = 5\text{ V}$

Notes:

1. "d" is the distance from the assembly's top surface to the reflective surface.
2. Measured using Eastman Kodak neutral white test card with 90% diffuse reflectance as a reflecting surface.
3. By designed but not tested.
4. Methanol or Isopropanol are recommended as cleaning agents. Plastic housing is soluble in chlorinated hydrocarbons and ketones.

### General Note

TT Electronics reserves the right to make changes in product specification without notice or liability. All information is subject to TT Electronics' own data and is considered accurate at time of going to print.

TT Electronics | OPTEK Technology  
2900 E. Plano Pkwy, Plano, TX 75074 | Ph: +1 972 323 2200  
www.ttelectronics.com | sensors@ttelectronics.com

# Reflective Object Sensor

Type OPB733TR



## Typical Performance Curves

**LED Maximum Forward Current Vs Ambient Temperature**

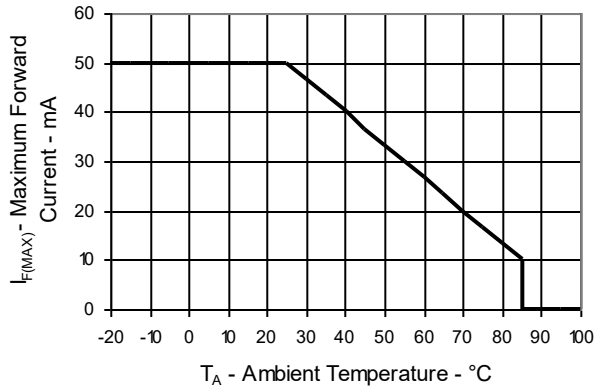

**Phototransistor Collector Power Dissipation Vs Ambient Temperature**

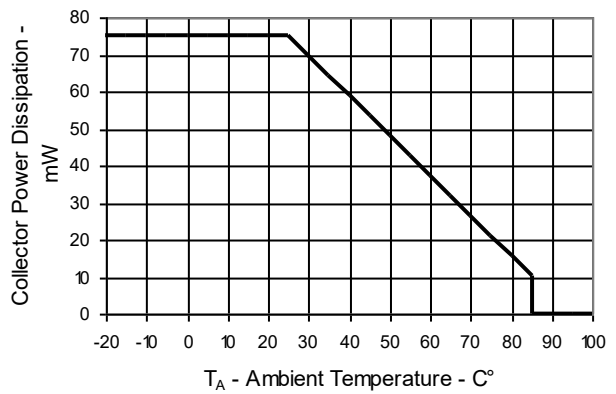

LED Forward Voltage Vs Forward Current

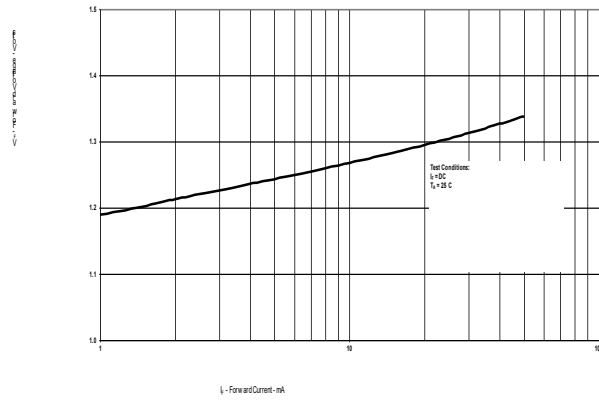

**LED Relative Radiant Intensity Vs Angular Displacement**

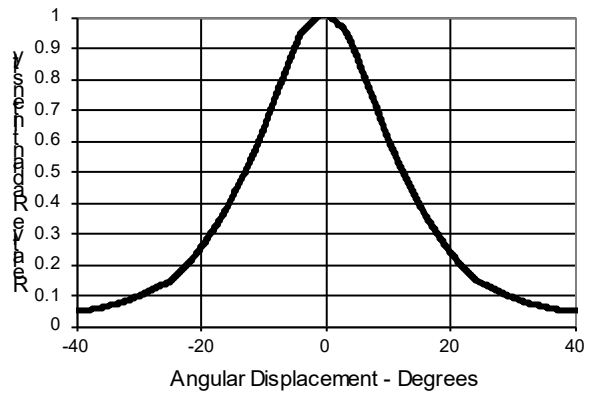

**Phototransistor Relative Spectral Response Vs Wavelength**

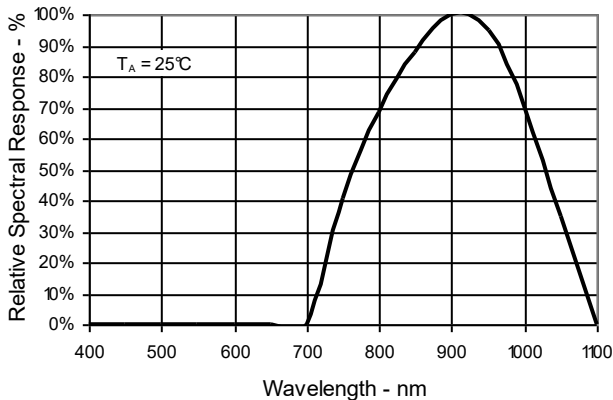

**Normalized Collector Current Vs LED Forward Current**

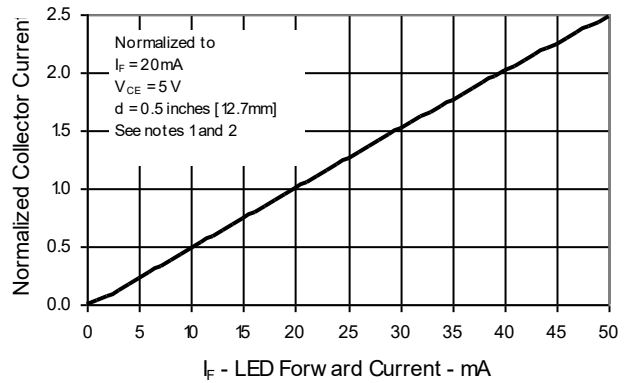

**General Note**

TT Electronics reserves the right to make changes in product specification without notice or liability. All information is subject to TT Electronics' own data and is considered accurate at time of going to print.

TT Electronics | OPTEK Technology  
 2900 E. Plano Pkwy, Plano, TX 75074 | Ph: +1 972 323 2200  
[www.ttelectronics.com](http://www.ttelectronics.com) | [sensors@ttelectronics.com](mailto:sensors@ttelectronics.com)

# Reflective Object Sensor

Type OPB733TR



## Typical Performance Curves

### Forward Voltage Vs Ambient Temperature

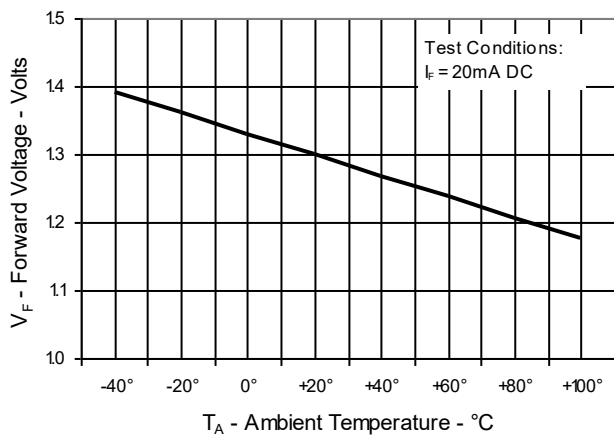

### Normalized Collector Current Vs Ambient Temperature

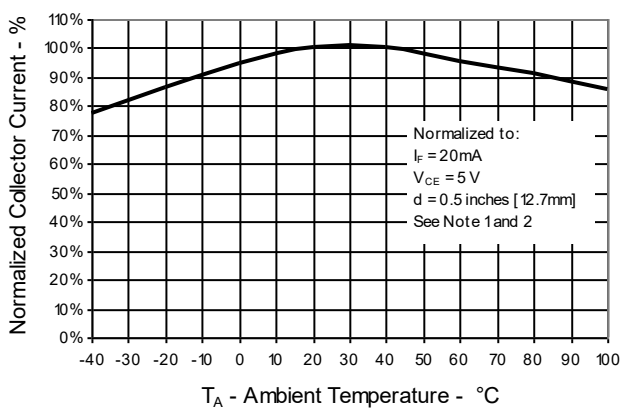

### Normalized Collector Current Vs Object Distance

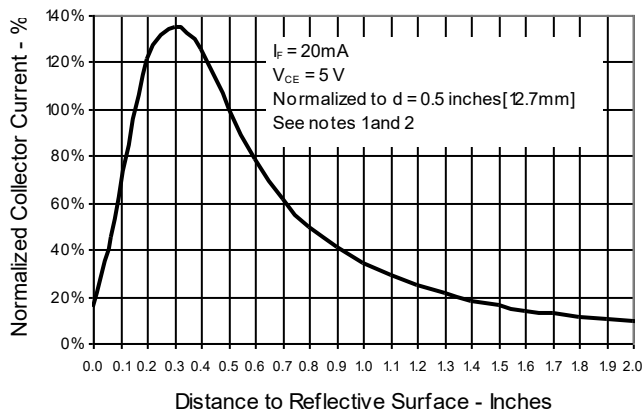

#### General Note

TT Electronics reserves the right to make changes in product specification without notice or liability. All information is subject to TT Electronics' own data and is considered accurate at time of going to print.

TT Electronics | OPTEK Technology  
2900 E. Plano Pkwy, Plano, TX 75074 | Ph: +1 972 323 2200  
www.ttelectronics.com | sensors@ttelectronics.com

# Reflective Object Sensor

Type OPB733TR



## Soldering Method:

- Reflow soldering profile shown below. Soldering should not exceed this curve in temperature and time.
- Avoid soldering more than once.
- Avoid exerting any type of pressure on the optical lenses and contact leads before, during, and after soldering.

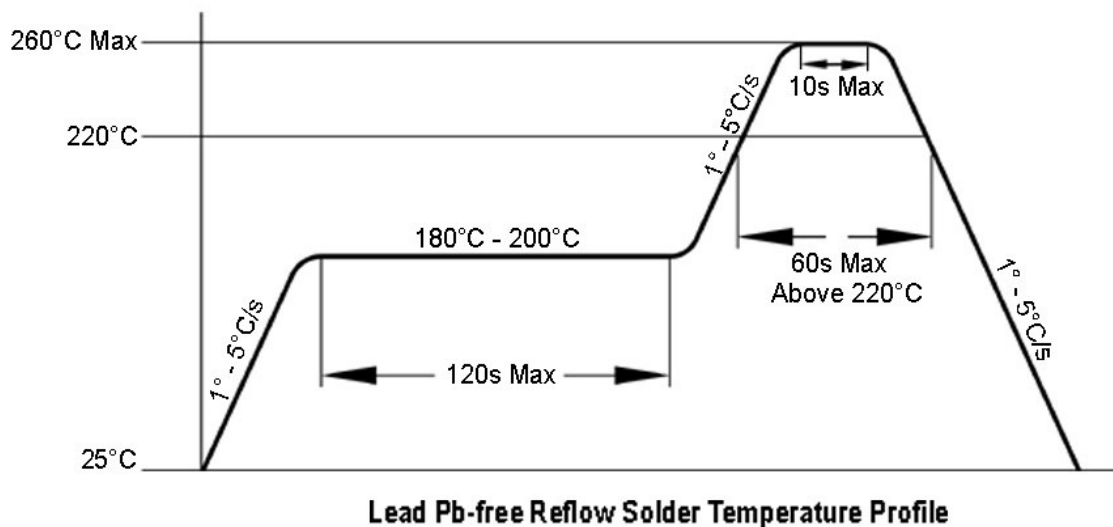

## Storage:

- Storage temperature and relative humidity (R.H.) conditions are: 5°C to 30°C and 70% R.H. or less.
- Moisture proof bag should be open only if devices are ready to be used. Devices should be utilized within 72 hours after package has been opened.
- After opening the package, devices should be kept at a temperature of 5°C to 30°C and 60% R.H. or less.
- If the devices have exceeded the storage time or the humidity card indicates 60% relative humidity level, all devices should go through a baking treatment outside the original package prior to usage. Baking treatment: 60°C +/- 5°C for 24 hours.



## Looking for pricing, stock, or lifecycle information?

Click below to explore more details on WIN SOURCE:

 [View OPB733TR on WIN SOURCE](#)

 [TT Electronics](#) Information

## Optimize Your Supply Chain with WIN SOURCE Solutions

-  Global Sourcing Solution
-  Obsolete Management
-  Cost Control Management
-  Shortage Management
-  Alternative Solution
-  Excess Inventory Management