



**THE DATASHEET OF
PM40036B1-F3EI**



Switchtec™ PFX Gen 4 Fanout PCIe® Switch Family

PM40100, PM40084, PM40068, PM40052, PM40036, PM40028

Summary

The Switchtec PFX Gen 4 Fanout PCIe Switch Family comprises high-reliability PCIe switches supporting up to 100 lanes, 52 ports, 26 virtual switch partitions, 48 non-transparent bridges (NTBs), hot- and surprise-plug controllers for each port, advanced error containment and comprehensive diagnostics and debug capabilities, a wide breadth of I/O interfaces and an integrated MIPS processor.

Typical applications for the PFX family include data center equipment, defense and industrial servers, workstations, test equipment, video production and broadcasting equipment, cellular infrastructure, access networks, metro networks and core networking.



Features

High-Performance Non-Blocking Gen 4 Switches

- 100-lane, 84-lane, 68-lane, 52-lane, 36-lane and 28-lane variants
- Ports bifurcate from to x1¹ /x2/x4/x8/x16 lanes
- Up to 48 NTBs assignable to any port
- Logical non-transparent (NT) interconnect allows for larger topologies
- Supports 1+1 and N+1 failover mechanisms

DMA Controller

- High-performance, ultra-low latency DMA engine

Error Containment

- Advanced Error Reporting (AER) on all ports
- Downstream Port Containment (DPC) on all downstream ports
- Completion Timeout Synthesis (CTS) to prevent an error state in an upstream host due to incomplete non-posted transactions
- Hot- and surprise-plug controllers per port
- GPIOs configurable for different cable/connector standards

PCIe Interfaces

- Passive, managed and optical cables
- SFF-8644, SFF-8643, SFF-8639, OCUlink and other connectors

Diagnostics and Debug

- Real-time eye capture
- External loopback capability

Highlights

- High-reliability PCIe: robust error containment, hot- and surprise-plug controllers per port, end-to-end data integrity protection, high-quality, low-power SERDES
- Comprehensive diagnostics and debugging: PCIe generator and analyzer, per-port performance and error counters, multiple loopback modes and real-time eye capture
- Significant power, cost and board space savings with support for:
 - Up to 52 ports, 48 NTBs, and 26 virtual switch partitions
 - Flexible x1¹, x2, x4, x8, and x16 port bifurcation with no restrictions on configuring ports as either upstream or downstream, or on mapping ports to NTBs
- Secure system solution with boot image authentication

¹ x1 natively on four lanes

Peripheral I/O Interfaces

- Up to 11 Two-Wire Interfaces (TWIs) with SMBus support
- Up to 4 SFF-8485-compliant SGPIO ports
- 10/100 Ethernet MAC port (MII/RMII) (PFX 96x/80x/64xG4)
- Up to 4 UARTs
- JTAG and EJTAG interface

High-Speed I/O

- PCIe Gen 4 16 GT/s
- Supports PCIe-compliant link training and manual PHY configuration
- Manual PHY configuration for optical

Power Management

- Active State Power Management (ASPM)
- Software-controlled power management

ChipLink Diagnostic Tools

- Extensive debug, diagnostics, configuration and analysis tools with an intuitive GUI
- Access to configuration data, management capabilities and signal integrity analysis tools (such as real-time eye capture)

Evaluation Kit

The PM42100-KIT Switchtec Gen 4 PCIe Switch Evaluation Kit is a device evaluation environment that supports multiple interfaces.

Example Application

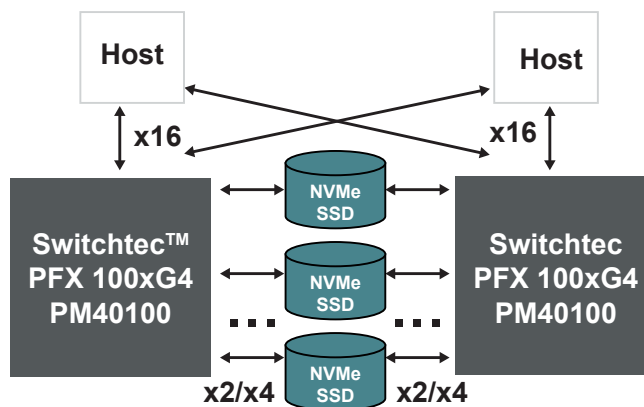

Ordering Information

Product	Part Numbers	Lanes	Ports/NTBs	Partitions	Hot-Plug Controllers
PFX 100xG4 Gen 4 Fanout PCIe® Switch	PM40100B-FEI	100	52/48	26	52
PFX 84xG4 Gen 4 Fanout PCIe Switch	PM40084B-FEI	84	44/42	22	44
PFX 68xG4 Gen 4 Fanout PCIe Switch	PM40068B-FEI	68	36/34	18	36
PFX 52xG4 Gen 4 Fanout PCIe Switch	PM40052B-F3EI	52	28/26	14	28
PFX 36xG4 Gen 4 Fanout PCIe Switch	PM40036B-F3EI	36	20/18	10	20
PFX 28xG4 Gen 4 Fanout PCIe Switch	PM40028B-F3EI	28	16/14	8	16

Looking for pricing, stock, or lifecycle information?

Click below to explore more details on WIN SOURCE:

- ⊖ [View PM40036B1-F3EI on WIN SOURCE](#)
- ⊖ [Microchip Technology](#) Information

Optimize Your Supply Chain with WIN SOURCE Solutions

- ✓ Global Sourcing Solution
- ✓ Obsolete Management
- ✓ Cost Control Management
- ✓ Shortage Management
- ✓ Alternative Solution
- ✓ Excess Inventory Management