



**THE DATASHEET OF
R3110-CBAA-E1T**



Pre-fit DSP Solution for Hearing Aids

RHYTHM R3110

Introduction

The RHYTHM™ R3110 hybrid from ON Semiconductor is a pre-fit DSP system that is based on a two-channel compression circuit and designed for entry level hearing aids. With no need for software configuration nor that of storing audiology parameters via computer fitting, R3110 is a simple, cost-effective solution with many features found in high-end hearing aids, including Adaptive Noise Reduction and Adaptive Feedback Cancellation. R3110 is targeted at replacing aging analog solutions; it offers the same ease of use, yet provides the superior performance of digital technology. In its simplest configuration, a hearing aid build using R3110 only requires four external electronic components.

Key Features and Benefits

- **Pre-Fit Audiology Parameters**– All sound-processing algorithms are preprogrammed to enable manufacturers to develop hearing aids in a variety of form-factors and to fit a wide range of hearing loss profiles. The device can also be configured for additional use-cases through hardware settings.
- **Trimmer-Based Fitting**– Up to four trimmers can be deployed, offering manufacturers the capability to modify most parameters that are important for patient fitting.
- **Mode Control**– Provides a variety of user control options: momentary or static switches, as well as an analog volume control.
- **Adaptive Feedback Canceller**– Automatically reduces acoustic feedback. It allows for an increase in stable gain while minimizing artifacts for music and tonal input signals
- **Automatic Telecoil Support**– Supports the use of telecoil devices, enabled either automatically with a magnetic sensitive switch or via an external switch
- **Adaptive Noise Reduction**– The adaptive noise reduction algorithm monitors signal and noise activities in 32 individual bands and carefully reduces noise
- **Tinnitus Masking**– A noise source can be enabled to mask tinnitus. The noise level is adjustable and mixed with the audio path. Spectral shaping is also possible using the high-cut and low-cut filters.



ON Semiconductor®

www.onsemi.com



21-PAD HYBRID
CASE 127DF

PIN NUMBERING

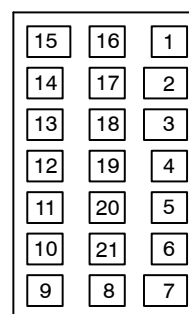

(Bottom View)

MARKING DIAGRAM

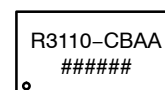

R3110-CBAA = Specific Device Code
= Work Order Number

ORDERING INFORMATION

See detailed ordering and shipping information on page 13 of this data sheet.

RHYTHM R3110

KEY SPECIFICATIONS

- Trimmer-Based Fitting:
 - ◆ Low-Cut Filter Corner Frequency
 - ◆ High-Cut Filter Corner Frequency
 - ◆ Wideband Gain
 - ◆ Tinnitus Noise Level
 - ◆ Output Limiting (AGC-O)
- Three Input Modes
 - ◆ Simple Mode
 - ◆ Advanced Mode
 - ◆ Telecoil Mode
- Push Button Support
- Analog Volume Control
- Basic Acoustic Indicators
- High Quality 20-bit Audio Processing
- High Power/High Gain Capability
- 16 kHz sampling rate (8 kHz bandwidth)
- High Fidelity Audio CODEC
- 96 dB Input Dynamic Range
- Drives Zero-Bias Two-Terminal Receivers
- E1 RoHS-compliant Hybrid
- Hybrid Typical Dimensions:
 - ◆ 200 x 122 x 39.4 mil (5.08 x 3.1 x 1.0 mm)
- R3110 is Pb-Free and RoHS Compliant

BLOCK DIAGRAM

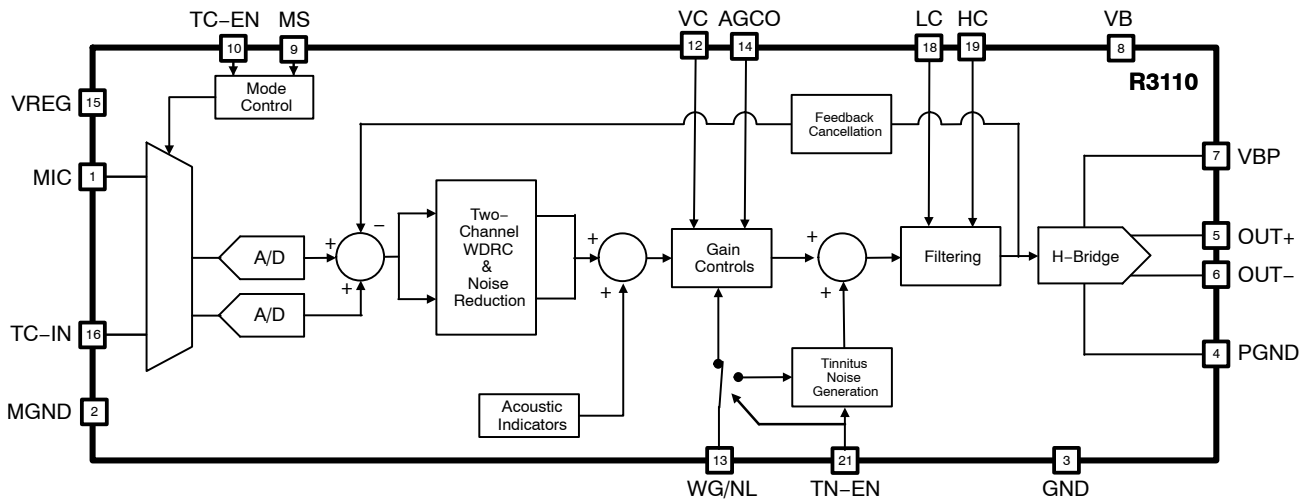

Figure 1. R3110 Block Diagram

SPECIFICATIONS

Table 1. ABSOLUTE MAXIMUM RATINGS

Parameter	Value	Unit
Operating Temperature Range	0 to 40	°C
Storage Temperature Range	-20 to + 70	°C
Absolute Maximum Power Dissipation	25	mW
Maximum Operating Supply Voltage	1.65	VDC
Absolute Maximum Supply Voltage	1.8	VDC

Stresses exceeding those listed in the Maximum Ratings table may damage the device. If any of these limits are exceeded, device functionality should not be assumed, damage may occur and reliability may be affected.

WARNING: Electrostatic Sensitive Device – Do not open packages or handle except at a static-free workstation.

WARNING: Moisture Sensitive Device – RoHS Compliant; Level 3 MSL. Do not open packages except under controlled conditions.

RHYTHM R3110

Table 2. ELECTRICAL CHARACTERISTICS (Supply Voltage $V_B = 1.25\text{ V}$; Temperature = 25°C)

Parameter	Symbol	Conditions	Min	Typ	Max	Units
Hybrid Current	IAMP	All functions, trimmers at default	–	550	–	μA
Minimum Operating Supply Voltage	VBOFF	Ramp down, audio path	0.93	0.95	0.97	V
		Ramp down, control logic	0.77	0.80	0.83	
Supply Voltage Turn On Threshold	VBON	Ramp up	1.06	1.10	1.16	V
Low Frequency System Limit	–	–	–	125	–	Hz
High Frequency System Limit	–	–	–	8	–	kHz
Total Harmonic Distortion	THD	$V_{IN} = -40\text{ dBV}$	–	–	1	%
THD at Maximum Input	THDM	$V_{IN} = -15\text{ dBV}$	–	–	3	%
Audio Path Latency	–	8 kHz bandwidth	–	4.2	–	ms
System Power on Time	–	–	–	3000	–	ms

REGULATOR

Regulator Voltage	V_{REG}	–	0.87	0.90	0.93	V
Regulator PSRR	PSRRSYS	1 kHz, Input referred	54	55	–	dB

INPUT

Input Referred Noise	IRN	Bandwidth 100 Hz– 8kHz	–	–108	–	dBV
Input Impedance	ZIN	1 KHz	–	3	–	$\text{M}\Omega$
Anti–Aliasing Filter Rejection	–	$f = f_{CLK}/2 - 8\text{ kHz}$, $V_{IN} = -40\text{ dBV}$	–	80	–	dB
Crosstalk	–	Between both A/D and Mux	–	60	–	dB
Maximum Input Level	–	–	–15	–13	–	dBV
Analog Input Voltage Range	VAN_IN	V_{IN1}	0	–	800	mV
	VAN_TIN	TIN	–100	–	800	
Input Dynamic Range	–	Bandwidth 100 Hz – 8 kHz	–	95	96	dB

OUTPUT

D/A Dynamic Range	–	100 Hz– 8 kHz	–	88	–	dB
Output Impedance	ZOUT	–	–	10	13	Ω

VOLUME CONTROL AND TRIMMERS

Control Resistance	–	Three– terminal connection	100	–	360	k Ω
Zero Scale Level	–	–	–	0	–	V
Full Scale Level	–	–	–	VREG	–	V
Volume Control Range	–	–	–42	–	0	dB
Low Cut Filter Control Range	–	–	10	–	2000	Hz
High Cut Filter Control Range	–	–	1000	–	8000	Hz
Wideband Gain Control Range	–	TN–EN grounded or floating	–30	–	0	dB
Noise Level Control Range	–	TN–EN pulled to V_B	–100	–	–25	dB
AGCO Control Range	–	–	–30	–	0	dB

DIGITAL CONTROL PINS

Pull–down resistance	–	–	–	1	–	$\text{M}\Omega$
Low–level current with pull–down	–	$V_i = 0$	–	100	–	μA
High–level current with pull–down	–	$V_i = V_B$	–	–1.2	–	μA

Product parametric performance is indicated in the Electrical Characteristics for the listed test conditions, unless otherwise noted. Product performance may not be indicated by the Electrical Characteristics if operated under different conditions.

RHYTHM R3110

Table 3. PIN CONNECTIONS

Pin Number	Pin Name	Signal Description	A/D/P	I/O	Active	Pull
1	MIC	Front microphone input	A	I		
2	MGND	Microphone ground	P	I		
3	GND	Ground	P	I		
4	PGND	Receiver ground	P	I		
5	OUT+	Receiver positive output	A	O		
6	OUT-	Receiver negative output	A	O		
7	VBP	H-bridge power supply	P	I		
8	VB	Main power supply	P	I		
9	MS	Mode select	D	I	RE	PD
10	TC-EN	Telecoil enable	D	I	H	PD
11	N/C	No connect	-	-		
12	VC	Volume control	A	I		
13	WG/NL	Wideband gain / Tinnitus noise level	A	I		
14	AGCO	AGCO level	A	I		
15	VREG	Regulated voltage	P	O		
16	TC-IN	Telecoil input	A	I		
17	N/C	No connect	-	-		
18	LC	Low-cut filter control	A	I		
19	HC	High-cut filter control	A	I		
20	N/C	No connect	-	-		
21	TN-EN	Tinnitus noise enable	D	I	H	PD

A/D/P:

A: Analog pin
D: Digital pin
P: Power pin

I/O:

I: Input
O: Output

Active:

RE: Active on a rising edge
H: Active High

Pull:

PD: Pulled down to GND

RHYTHM R3110

TYPICAL APPLICATION

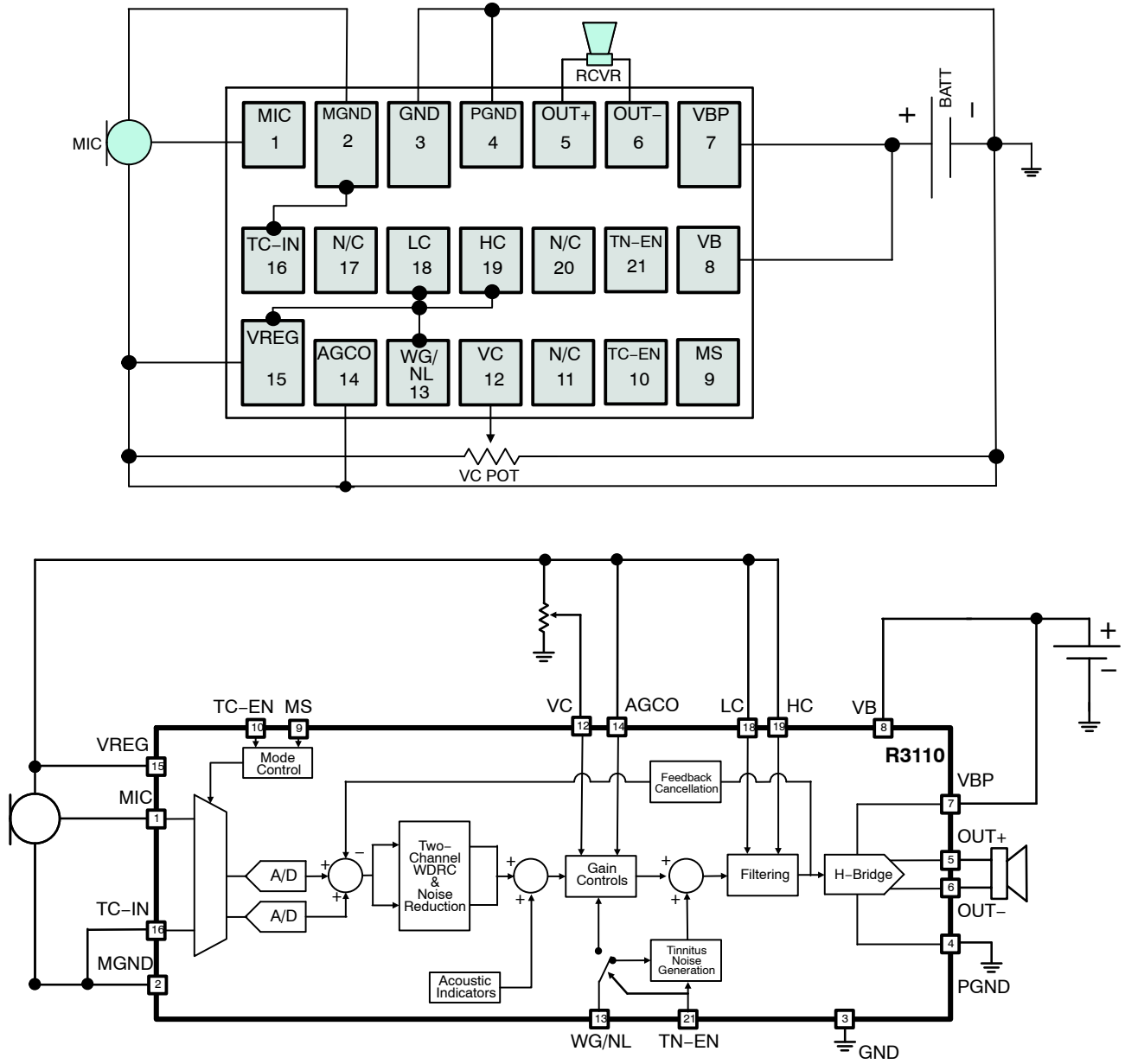

Figure 2. A typical hearing device with R3110: Reference Schematic and Wiring Diagram

RHYTHM R3110

FUNCTIONAL BLOCK DESCRIPTION

Analog Input and Output Stages

R3110 provides two analog inputs: Microphone 1 (MIC), and Telecoil (TC-IN). The following input modes can be selected:

1. Simple Mode, which features two channels of compression. This mode is ideally suited for analog replacement hearing aids and for quiet listening environments.
2. Advanced Mode, where the addition of Adaptive Noise Reduction and Adaptive Feedback Cancellation offers the user better listening comfort in noisier listening environments.
NOTE: You can set Advanced Mode as the default by tying the MS pin to the VB pin.
3. Telecoil Mode (TCM), where R3110 is not processing any microphone signal and is only sampling the signal coming from a telecoil device present on the TC-IN pin.

Important Note: All input transducers (microphones and telecoil) shall use the VREG pin for power and the MGND pin for ground. All unused analog inputs shall be connected to MGND. The MGND pin shall not be connected to the main ground pin (GND)

R3110 includes two 2nd-order sigma-delta analog to digital converters that are used to sample the relevant analog inputs, according to the selected input mode in which the device is operating. The inputs are preconditioned with anti-alias filtering and amplification before being supplied to the Digital Signal Processing engine (DSP).

After processing by the DSP, a digital to analog converter comprised of a 3rd-order sigma-delta modulator and an H-bridge will render the processed signal into the analog domain. The modulator accepts digital audio data from the DSP path and converts it into a 64-times oversampled, 1-bit PDM data stream, which is then supplied to the H-bridge. The H-bridge is a specialized CMOS output driver used to convert the 1-bit data stream into a low-impedance, differential output voltage waveform suitable for driving zero-biased hearing aid receivers.

Microphone and Receiver Selection

R3110 supports multiple types of three-terminal hearing aid microphones operating from a regulated voltage of 0.9 V. Acoustic-referred threshold values for the Wide Dynamic Range Compressor (WDRC) engine and acoustic indicators are also determined by the microphone sensitivity and frequency response. The adaptive feedback suppression and adaptive noise reduction automatically adjust their behavior according to the properties of the selected microphone.

Similarly to the microphone selection, R3110 is designed to support a variety of zero-bias hearing aid receivers. For high power devices, a first order RC filter is recommended to ensure a clean power supply to R3110, despite the large current required by the receiver. Refer to Figure 3 for a recommended high-power output filter.

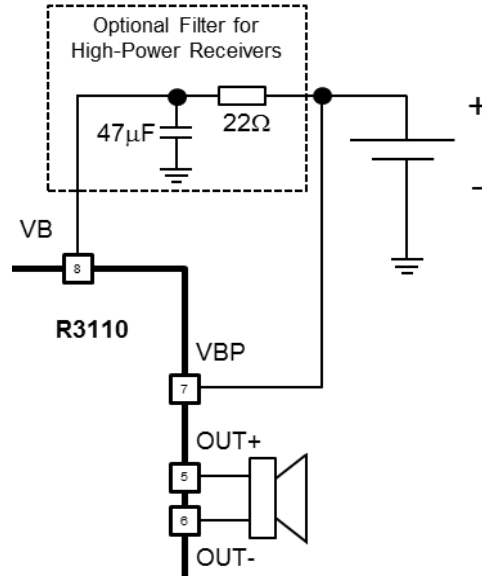

Figure 3. Typical High-Power Filter

Telecoil Support

R3110 is designed to support multiple uses of a telecoil device. It allows transitioning into telecoil mode upon the closing of a switch connected to the TC-EN pin (#10). A static 2-pole switch can be used to initiate such a transition. Alternatively, with a magnetic sensitive switch (such as a GMR or Reed switch) connected to TC-EN, the static magnetic field of a telephone handset will close the switch whenever the handset is brought close to the hearing aid, resulting in R3110 changing to telecoil mode (TCM). When this functionality is used, the MS pin (#9) shall be left floating.

For both cases, static and automatic telecoil control, a debouncing algorithm is used to prevent undesired switching in and out of telecoil mode due to mechanical switch bounces. Upon detecting a close to open switch transition, the debounce algorithm monitors the switch status and switches R3110 out of telecoil mode and back to the initial mode, only once the switch signal has been continuously sampled open over a 1.5 seconds period.

A third option allows R3110 to enter the telecoil mode when only a momentary push button is used on the mode select pin (MS) and no switch is present on TC-EN. Please refer to the Push Button Support section for additional details.

RHYTHM R3110

Channel Processing

R3110 includes a two-channel processing system with the I/O characteristics as defined in Figure 4:

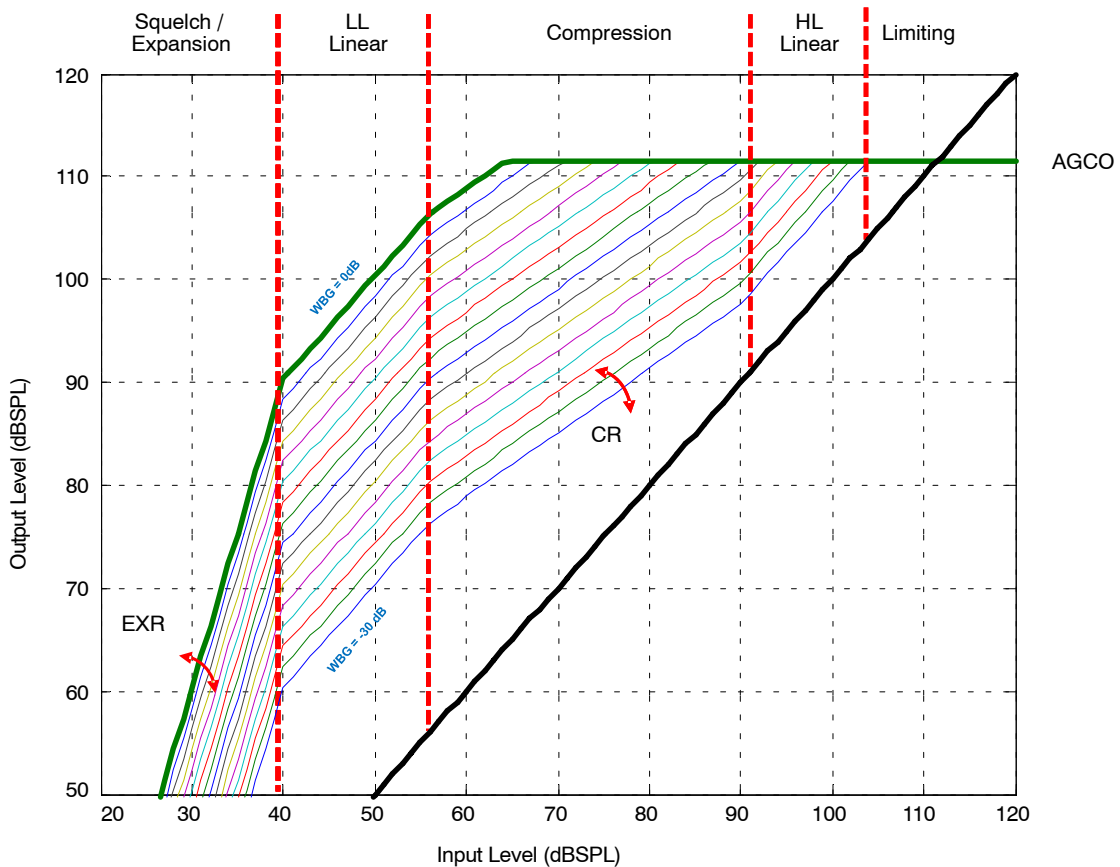

Figure 4. Wide Dynamic Range Compression

The WDRC as defined in R3110 has identical settings for each of the two channels, but the gains in each of these two channels may be different, depending on the dynamics of the incoming signals. They crossover frequency between the two channels is set at 1.625 kHz.

The I/O curve can be divided into five main regions:

- A low input level expansion (squelch) region with a compression ratio of 1:2
- A low input level linear region
- A compression region with a compression ratio of 1.6:1
- A high input level linear region (return to linear)
- A limited output region

The configuration of the WDRC parameters has been calculated with a default microphone and receiver selection such that all the quantities shown on the graph represent acoustic quantities. As previously explained, any change in microphone or receiver characteristics and or sensitivities

will result in a different behavior of the WDRC. In such cases, the WDRC parameters can easily be recalculated, knowing that the microphone sensitivity that was used is $-126 \text{ dBV} / \text{dB SPL}$, and that the default receiver sensitivity that was used is of $115.4 \text{ dB SPL} / \text{dBV}$. The selected units for these sensitivities have been selected such that they are compatible with traditional software tools for other ON Semiconductor preconfigured products.

As shown in Figure 4, one of the parameters that can be controlled is the Wideband Gain. A number of curves are shown, with the default value being the maximum wideband gain (0 dB). The minimum value for this parameter is -30 dB , which has quite some impact on the WDRC.

A second and last parameter can be modified on R3110, is the limiting factor (AGCO). Figure 5, shows the input output curve for the default wideband gain configuration (0 dB), but with all the different options of the limiting factor and their impact on the output level.

RHYTHM R3110

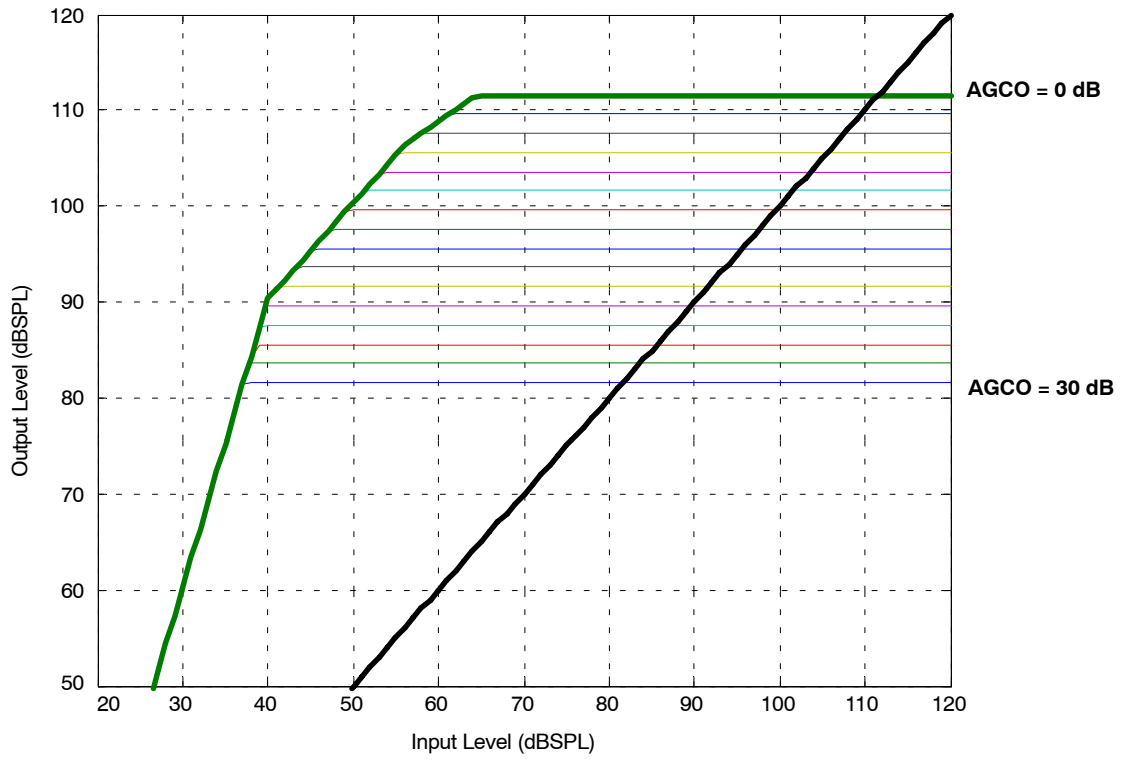

Figure 5. Controlling the Output Limiter (AGC-O)

Adaptive Noise Reduction

The Adaptive Noise Reduction (ANR) algorithm deploys a high resolution 32-band filter bank enabling precise reduction of noise. The algorithm monitors the signal-to-noise ratio activity in these bands, and calculates a separate attenuation gain for each of the 32 bands. Noise reduction has been included in the advanced hearing aid mode option which can be obtained either by using a momentary memory select switch on MS1 (allowing the switching between Basic, Advanced and telecoil mode) or by hard wiring MS to VB to automatically start in Advanced Mode.

Third Generation Adaptive Feedback Canceller

The third generation Adaptive Feedback Canceller (AFC) reduces acoustic feedback by calculating an estimate of the hearing aid feedback signal and then subtracting it from the hearing aid input signal. The forward path of the hearing aid is not affected. Unlike adaptive notch filter approaches, the AFC in R3110 does not reduce the hearing aid's gain. The AFC is based on a time-domain model of the feedback path. The AFC allows for an increase in the stable gain of the hearing instrument while minimizing artefacts on music and tonal input signals. The AFC is fully automatic and is configured in R3110 to support all types of hearing aids, allowing a distance from receiver to microphone as low as 2 centimeters. AFC is available in Advanced Mode and can be selected via the MS pin with a push button or by hard wiring MS to VB.

Analog Volume Control

The external analog volume control works with a three-terminal 100 k Ω – 360 k Ω potentiometer connected between ground (GND) and the regulated voltage (VREG). The volume control shall have a linear taper. The potentiometer must be connected to the VC pin. It allows controlling the output attenuation from full scale down to approximately 42 dB under full scale. This volume control does not affect the tinnitus noise signal level when used.

Trimmers

R3110 is a pre-fit device for which all the sound-processing algorithm parameters have been preconfigured. Nonetheless, four parameters have been assigned to four trimmer pins (referred to as “configuration pins” throughout this document, allowing these parameters to be adjusted externally. The four configuration pins are the following:

- LC: Allows to configure the low-cut filter corner frequency
- HC: Allows to configure the high-cut filter corner frequency
- WG/NL: Allows adjusting either the wideband gain, or the tinnitus noise level, depending on the state of the TN-EN pin (enables the tinnitus noise generation algorithm). When configured for its Wideband Gain functionality (WG), this pin allows controlling the overall gain of the device as per the 16 values defined in Table 4. When used in its Noise Level (NL) functionality, it only scales the level of the generated tinnitus noise as per one of the 16 values also defined in Table 4.
- AGCO: Allows to select the maximum output signals to adjust to a particular receiver. The AGC-O module is an output limiting circuit with a fixed compression ratio of ∞ : 1. The limiting level is adjustable through the AGCO pin as a level measured in dB from full scale. The maximum output of the device is 0 dBFS. The AGC-O module has its own level detector, with fixed attack and release time constants.

Figure 1 shows the signal path and the relative position of these filtering and amplification blocks in the audio path.

There are three possible ways to use these configuration pins:

1. No configuration is performed; in this case, the four configuration pins are connected to VREG. R3110 will be using its predefined default values for all four parameters. The default values are defined by the configuration #16 in Table 4 below.
2. Resistive dividers are used to provide a fixed value to any of the parameters controlled by the four configuration pins. Table 4 shows parameter values related to corresponding configuration numbers (1 to 16). Figure 6 lists the corresponding component values to use in the resistive divider (R1 and R2).
3. A trimmer can be connected to any of the four configuration pins, allowing the parameter to be controlled by the audiologist or the end user. The trimmer shall be a three-terminal 100 k Ω linear taper. The range that the trimmer will offer is defined in Table 4. Maximum gains and frequency ranges are obtained with the default value set #16, which also corresponds to the default position of the trimmer, which is obtained when the trimmer is turned to its end position, clock wise.

RHYTHM R3110

Config	Typical Voltage [mV]	R1 (E24)	R2 (E24)
16	VREG	1K	OPEN
15	870	3.3K	100K
14	831	8.2K	100K
13	782	15K	100K
12	725	24K	100K
11	658	36K	100K
10	579	56K	100K
9	494	82K	100K
8	407	100K	82K
7	321	100K	56K
6	242	100K	36K
5	175	100K	24K
4	118	100K	15K
3	69	100K	8.2K
2	30	100K	3.3K
1	GND	OPEN	1K

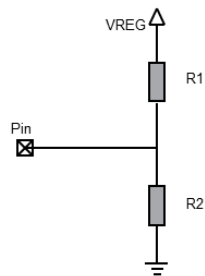

Figure 6. 16 Configurations and their Resistor Values

Table 4. PARAMETER VALUES AND RANGES

Pin Name:	LC	HC	WG/NL	WG/NL	AGCO	
TN-EN	X	X	0	1	X	
Parameter Description:	Low-Cut Filter Corner Frequency	High-Cut Filter Corner Frequency	Wideband Gain	Noise Level	AGC-O	
Units:	Hz	Hz	dB	dB	dB	
Config #	Voltage on pin [mV]	Parameter Values				
16 (Default)	900 (VREG)	10	8000	0	-25	0
15	870.1	125	7500	-2	-30	-2
14	831.4	160	7100	-4	-35	-4
13	782.2	200	6700	-6	-40	-6
12	725.1	250	6000	-8	-45	-8
11	658.3	315	5600	-10	-50	-10
10	579.2	400	4750	-12	-55	-12
9	493.9	500	4000	-14	-60	-14
8	406.9	630	3350	-16	-65	-16
7	320.8	800	2800	-18	-70	-18
6	241.7	1000	2370	-20	-75	-20
5	174.9	1250	2000	-22	-80	-22
4	117.8	1600	1700	-24	-85	-24
3	68.55	1700	1400	-26	-90	-26
2	29.88	1800	1180	-28	-95	-28
1	0 (GND)	2000	1000	-30	-100	-30

Noise Generator for Tinnitus Treatment

R3110 offers a dedicated pin to control the Tinnitus Treatment noise generation algorithm: TN-EN. This pin has an internal pull-down resistor to ground (GND), which disables the algorithm by default. When activated (pulled to VB), Tinnitus Treatment is generated deploying amplitude-scaled white noise, depending on adjustments made via pin WB/NL. When the TN-EN pin is set high (connected to VB) to enable the tinnitus algorithm, the WB/NL pin controls the generated noise level (NL) as per Table 4. The noise is injected into the audio path, as shown in the block diagram of Figure 1 and the entire audio signal is shaped using the internal filters controlled by the LC and HC pins. The VC pin and, consequently the amount of attenuation that it selects, only affects the audio signal and not the tinnitus noise level. The tinnitus mode can be used in conjunction with all three modes (Simple, Advanced and Telecoil). In this configuration, it will control the tinnitus noise level instead.

Using the R3110 Solely as a Tinnitus Masker Device:

R3110 can also be used as a tinnitus only device with no microphones at all, only one receiver. In this configuration all inputs will be connected to MGND (MIC and TC-IN).

Push Button Support

R3110 supports the use of momentary switches via the Mode Select (MS) pin (#9). It allows rotating between the three input modes (Simple, Advanced and Telecoil) as defined earlier, this in a sequential manner. A momentary switch needs to connect the MS pin (#9) to the VB pin (#8) to enable this functionality. R3110 will switch from Simple to Advanced Mode, then Telecoil, and then back to Simple, each time the momentary switch is pushed. When this function is not desired in the end product, the hearing aid, the MS pin can be left floating.

Acoustic Indicators

In the configurations outlined both in the Telecoil Support and in the Push Button Support sections, whenever R3110 transitions between modes, the audio path is temporarily faded-out and an acoustic indicated is played. R3110 has preconfigured acoustic indicators to notify the user of the following events:

- Device startup
 - ◆ Four sequential tones with the following audio frequencies: A4 (440 Hz), F4 (349 Hz), G4 (392 Hz), C4 (262 Hz)
- MS pin: mode switches with momentary push button
 - ◆ Simple mode: one tone at the C5 audio frequency (523 Hz)
 - ◆ Advanced mode: two sequential tones with increasing audio frequencies G4 (392 Hz) and C5 (523 Hz), 250 ms duration and 50 ms silence between the tones.

- ◆ Telecoil mode: three faded tones with increasing audio frequencies E4 (330 Hz), G4 (392 Hz) and C5 (523 Hz).
- TC-EN pin : telecoil mode enabled
 - ◆ Four sequential tones with increasing audio frequencies C4 (262 Hz), E4 (330 Hz), G4 (392 Hz) and C5 (523 Hz).
- Low battery
 - ◆ Three sequential tones with decreasing audio frequencies G4 (392 Hz), E4 (330 Hz) and C4 (262 Hz).

All tones exhibit a nominal 32 ms fade-in and fade-out transition time. The duration of all the tones is 250 ms, and the silence duration between tones is 50 ms. The level of the tones is input referred and determined dynamically by R3110 based on the input signal level as well as the volume control.

Power Management and Low Battery Warning

As the voltage on the hearing aid battery decreases under 1.1 V, an audible warning signal is given to the user indicating that the battery life is low. This indicator is repeated every five minutes until the battery voltage is further decreased under 0.88 V, at which point the device shuts down. In addition to this audible warning and before shut down, the hearing aid applies a sophisticated power management scheme to ensure proper operation given the weak battery supply and to maximize the device's usable battery life by reducing the gain to stabilize the supply based on the instantaneous and average supply voltage levels.

Evaluation Environment and Hybrid Jig

The performances of R3110 can be evaluated by using the hybrid jig evaluation board. As can be seen on Figure 1, a number of evaluation features have been designed on the hybrid jig, such as input and output audio connectors, output amplification circuitry, microphone headers, push buttons, toggle switches, analog potentiometers, a USB connection as well as a wealth of other useful features that will allow easy evaluation of the R3110 hybrid.

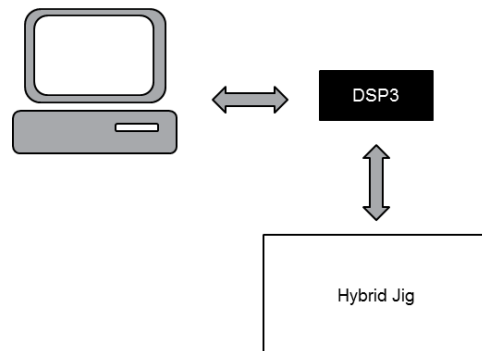

Figure 7. Hybrid Jig

RHYTHM R3110

Aside from this evaluation hardware, a monitoring utility is available and shown on Figure 2. This basic command line tool provides an extremely useful mechanism to read important information out of a R3110 hybrid such that the current input mode, the state of digital control pins, and the presence of valid audio in the input channels or the status of the configuration pins.

Test Mode

Using the R3110 Monitoring Utility, you can put R3110 into Test Mode, which disables adaptive algorithms and can be useful when running tests that require this configuration. There is also a secondary mechanism to enter Test Mode which does not require the use of a computer or the connection of the I²C pads. When a voltage of greater than 1.5 V is applied to the VB pad during boot, R3110 will enter Test Mode, even with MS tied to VB (which would normally enable Advanced Mode). It is recommended to use a voltage between 1.52 V and 1.57 V if possible. Do not exceed the maximum supply voltage as described in Table 1.

You can exit Test Mode by restarting R3110 (at nominal voltage) regardless of how it entered Test Mode.

When comparing results with and without adaptive algorithms running, you should expect to see some differences, depending on the test signal used.

NOTE: Test Mode is not necessary in R3110's Simple Mode.

Monitoring Utility Batch Files

To make the use of the basic command line tool easier, a set of batch files is provided which may be executed from within the Windows environment. These files are located on the R3110 product page at www.onsemi.com. Once you have downloaded the file, please follow these steps:

1. Download and unzip the files to the R3110MU\bin\ directory
2. Right click on the batch file name with the required parameters and save a shortcut to your desktop
3. Clicking on the desktop shortcut will launch the R3110 Monitor utility with the correct parameters.

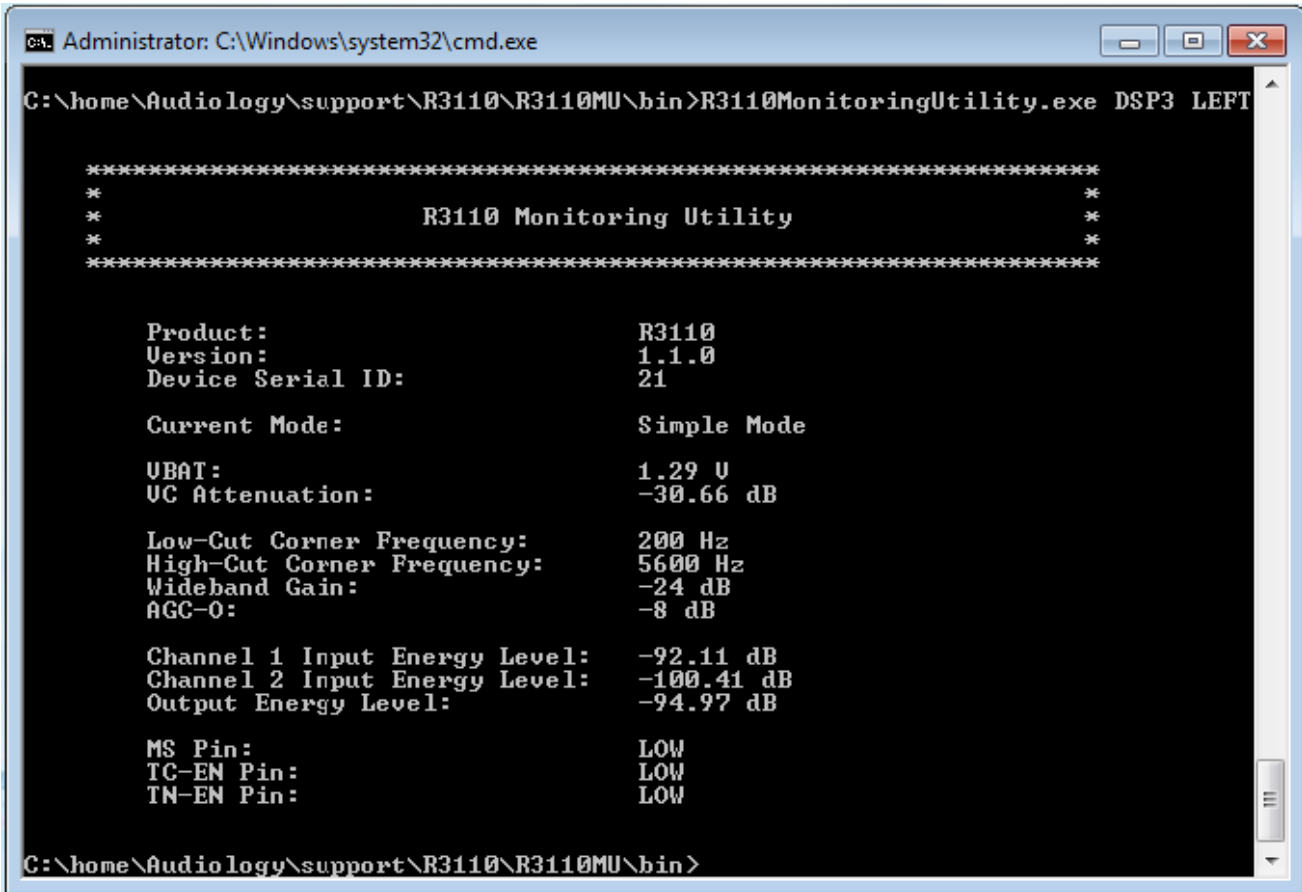

Figure 8. Monitoring Utility

RHYTHM R3110

ORDERING INFORMATION

Device	Marking	Package	Shipping†
R3110-CBAA-E1T	R3110-E1	21 Pad Hybrid	250 Units / Tape & Reel

†For information on tape and reel specifications, including part orientation and tape sizes, please refer to our Tape and Reel Packaging Specification Brochure, BRD8011/D.

Hybrid Jig Ordering Information

To order a Hybrid Jig Evaluation Board for R3110, contact your Sales Account Manager or FAE and use part number R3110GEVB.

Table 5. PAD POSITIONS AND DIMENSIONS

Pin No.	Pin Name	Pad Position		Pad Dimension	
		X (mil / mm)	Y (mil / mm)	Xdim (mil / mm)	Ydim (mil / mm)
1	MIC	-81.0 / -2.057	40.5 / 1.029	20.0 / 0.508	23.0 / 0.584
2	MGND	-54.0 / -1.372	38.0 / 0.965	20.0 / 0.508	28.0 / 0.711
3	GND	-27.0 / -0.686	38.0 / 0.965	20.0 / 0.508	28.0 / 0.711
4	PGND	0.0 / 0.0	40.5 / 1.029	20.0 / 0.508	23.0 / 0.584
5	OUT+	27.0 / 0.686	40.5 / 1.029	20.0 / 0.508	23.0 / 0.584
6	OUT-	54.0 / 1.372	40.5 / 1.029	20.0 / 0.508	23.0 / 0.584
7	VBP	81.0 / 2.057	38.0 / 0.965	20.0 / 0.508	28.0 / 0.711
8	VB	81.0 / 2.057	0.0 / 0.0	20.0 / 0.508	23.0 / 0.584
9	MS	81.0 / 2.057	-40.5 / -1.029	20.0 / 0.508	23.0 / 0.584
10	TC-EN	54.0 / 1.372	-40.5 / -1.029	20.0 / 0.508	23.0 / 0.584
11	N/C	27.0 / 0.686	-40.5 / -1.029	20.0 / 0.508	23.0 / 0.584
12	VC	0.0 / 0.0	-40.5 / -1.029	20.0 / 0.508	23.0 / 0.584
13	WG/NL	-27.0 / -0.686	-40.5 / -1.029	20.0 / 0.508	23.0 / 0.584
14	AGCO	-54.0 / -1.372	-40.5 / -1.029	20.0 / 0.508	23.0 / 0.584
15	VREG	-81.0 / -2.057	-38.0 / -0.965	20.0 / 0.508	28.0 / 0.711
16	TC-IN	-81.0 / -2.057	0.0 / 0.0	20.0 / 0.508	23.0 / 0.584
17	N/C	-54.0 / -1.372	0.0 / 0.0	20.0 / 0.508	23.0 / 0.584
18	LC	-27.0 / -0.686	0.0 / 0.0	20.0 / 0.508	23.0 / 0.584
19	HC	0.0 / 0.0	0.0 / 0.0	20.0 / 0.508	23.0 / 0.584
20	N/C	27.0 / 0.686	0.0 / 0.0	20.0 / 0.508	23.0 / 0.584
21	TN-EN	54.0 / 1.372	0.0 / 0.0	20.0 / 0.508	23.0 / 0.584

RHYTHM is a trademark of Semiconductor Components Industries, LLC.

MECHANICAL CASE OUTLINE

PACKAGE DIMENSIONS

ON Semiconductor®



SCALE 2:1

SIP21, 3.10x5.08
CASE 127DF
ISSUE O

DATE 20 MAR 2014

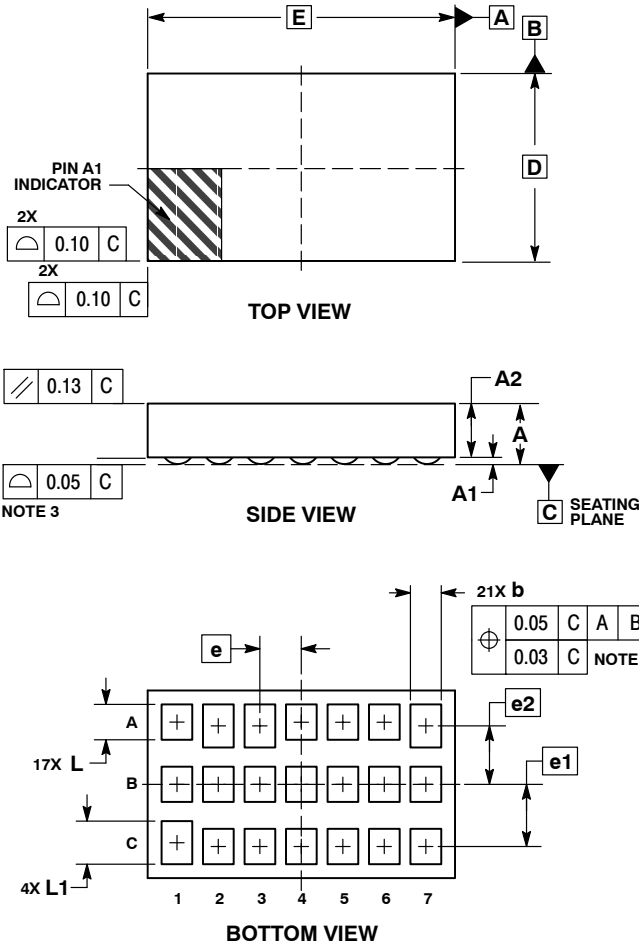

NOTES:

1. DIMENSIONING AND TOLERANCING PER ASME Y14.5M, 1994.
2. CONTROLLING DIMENSION: MILLIMETERS.
3. COPLANARITY APPLIES TO THE SPHERICAL CROWNS OF THE SOLDER BALLS.
4. DIMENSIONS b, L, AND L1 ARE MEASURED AT THE SURFACE OF THE PACKAGE BODY.

DIM	MILLIMETERS	
	MIN	MAX
A	---	1.14
A1	0.07	0.17
A2	0.889 REF	
b	0.470	0.546
D	3.100 BSC	
E	5.080 BSC	
e	0.686 BSC	
e1	1.029 BSC	
e2	0.965 BSC	
L	0.546	0.622
L1	0.673	0.749

GENERIC MARKING DIAGRAM*

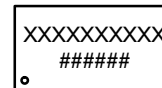

XX = Specific Device Code
= Work Order Number

*This information is generic. Please refer to device data sheet for actual part marking. Pb-Free indicator, "G" or microdot "•", may or may not be present.

RECOMMENDED SOLDERING FOOTPRINT*

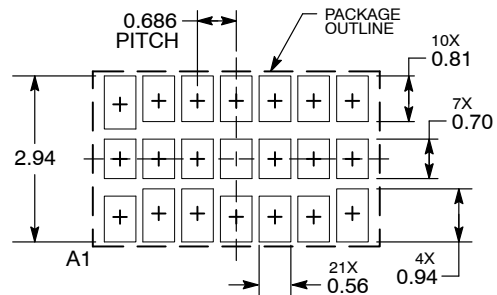

DIMENSIONS: MILLIMETERS

*For additional information on our Pb-Free strategy and soldering details, please download the ON Semiconductor Soldering and Mounting Techniques Reference Manual, SOLDERRM/D.

DOCUMENT NUMBER:	98AON82679F	Electronic versions are uncontrolled except when accessed directly from the Document Repository. Printed versions are uncontrolled except when stamped "CONTROLLED COPY" in red.
DESCRIPTION:	SIP21, 3.10X5.08	PAGE 1 OF 1

ON Semiconductor and are trademarks of Semiconductor Components Industries, LLC dba ON Semiconductor or its subsidiaries in the United States and/or other countries. ON Semiconductor reserves the right to make changes without further notice to any products herein. ON Semiconductor makes no warranty, representation or guarantee regarding the suitability of its products for any particular purpose, nor does ON Semiconductor assume any liability arising out of the application or use of any product or circuit, and specifically disclaims any and all liability, including without limitation special, consequential or incidental damages. ON Semiconductor does not convey any license under its patent rights nor the rights of others.

onsemi, **Onsemi**, and other names, marks, and brands are registered and/or common law trademarks of Semiconductor Components Industries, LLC dba "**onsemi**" or its affiliates and/or subsidiaries in the United States and/or other countries. **onsemi** owns the rights to a number of patents, trademarks, copyrights, trade secrets, and other intellectual property. A listing of **onsemi**'s product/patent coverage may be accessed at www.onsemi.com/site/pdf/Patent-Marking.pdf. **onsemi** reserves the right to make changes at any time to any products or information herein, without notice. The information herein is provided "as-is" and **onsemi** makes no warranty, representation or guarantee regarding the accuracy of the information, product features, availability, functionality, or suitability of its products for any particular purpose, nor does **onsemi** assume any liability arising out of the application or use of any product or circuit, and specifically disclaims any and all liability, including without limitation special, consequential or incidental damages. Buyer is responsible for its products and applications using **onsemi** products, including compliance with all laws, regulations and safety requirements or standards, regardless of any support or applications information provided by **onsemi**. "Typical" parameters which may be provided in **onsemi** data sheets and/or specifications can and do vary in different applications and actual performance may vary over time. All operating parameters, including "Typicals" must be validated for each customer application by customer's technical experts. **onsemi** does not convey any license under any of its intellectual property rights nor the rights of others. **onsemi** products are not designed, intended, or authorized for use as a critical component in life support systems or any FDA Class 3 medical devices or medical devices with a same or similar classification in a foreign jurisdiction or any devices intended for implantation in the human body. Should Buyer purchase or use **onsemi** products for any such unintended or unauthorized application, Buyer shall indemnify and hold **onsemi** and its officers, employees, subsidiaries, affiliates, and distributors harmless against all claims, costs, damages, and expenses, and reasonable attorney fees arising out of, directly or indirectly, any claim of personal injury or death associated with such unintended or unauthorized use, even if such claim alleges that **onsemi** was negligent regarding the design or manufacture of the part. **onsemi** is an Equal Opportunity/Affirmative Action Employer. This literature is subject to all applicable copyright laws and is not for resale in any manner.

ADDITIONAL INFORMATION

TECHNICAL PUBLICATIONS:



Technical Library: www.onsemi.com/design/resources/technical-documentation
onsemi Website: www.onsemi.com

ONLINE SUPPORT: www.onsemi.com/support

For additional information, please contact your local Sales Representative at www.onsemi.com/support/sales

Looking for pricing, stock, or lifecycle information?

Click below to explore more details on WIN SOURCE:

-  [View R3110-CBAA-E1T on WIN SOURCE](#)
-  [ON Semiconductor Information](#)

Optimize Your Supply Chain with WIN SOURCE Solutions

-  Global Sourcing Solution
-  Obsolete Management
-  Cost Control Management
-  Shortage Management
-  Alternative Solution
-  Excess Inventory Management