



THE DATASHEET OF HDC1010EVM



HDC1010EVM User's Guide

User's Guide



Literature Number: SNAU199
July 2016

1	Introduction	6
2	Setup	6
	2.1 Input/Output Connector Description	7
	2.2 Hardware Setup	7
	2.3 Software Setup	8
	2.4 Operation	13
	2.5 Reducing the SensorThermal Mass.....	14
3	GUI Operation	15
	3.1 Starting the GUI.....	15
	3.2 Connecting the EVM	16
	3.3 Navigating the GUI	18
	3.4 Configuring the Device using Register Page	19
	3.5 Configuring the Device using Configuration Page.....	28
	3.6 Streaming Measurement Data	29
	3.7 Updating the EVM Firmware	39
4	Board Layout	43
5	Schematic	44
6	HDC1010EVM Bill of Materials	45

List of Figures

1	HDC1010EVM.....	6
2	HDC1010EVM : Sensor module	7
3	HDC1010EVM: Layout Resistors for I2C Address Setting - Top.....	8
4	HDC1010EVM: Layout Resistors for I2C Address Setting - Bottom	8
5	GUI Installer Welcome Page	9
6	GUI Installer License Agreement.....	10
7	GUI Installer Installation Directory	10
8	GUI Installer Copying Files.....	11
9	EVM Driver Installer Welcome Page.....	11
10	EVM Driver Installer In Progress	12
11	EVM Driver Installer Complete	12
12	GUI Installer Complete	13
13	HDC1010EVM : PC Interface and Sensor Module	14
14	HDC1010EVM : PC Interface and Smaller Sensor Module	14
15	HDC1010EVM : Pads for I2C and Supply of the Smaller Sensor Module.....	14
16	GUI Splash Screen.....	15
17	GUI Introduction Page	16
18	GUI Disconnected From EVM	17
19	GUI Connected from EVM	17
20	GUI Menu Button	18
21	GUI Navigation Menu.....	19
22	Selecting Auto-Read Interval on Register Page.....	20
23	Selecting a Register's Current Value for Editing on Register Page.....	21
24	Entering New Value for Register on Register Page	21
25	Register Value Updated After Changing Value on Register Page.....	22
26	Hovering Mouse Over Register Bit Value on Register Page	22
27	Toggling Register Bit Value on Register Page	23
28	Selecting a Register on Register Page.....	24
29	Reading the Current Device Register Value on Register Page	24
30	Save Register Values to File on Register Page.....	25
31	Choosing a JSON File Name to Save Register Values	26
32	Loading Previously Saved Register Values from File on Register Page	27
33	Selecting Previously Save Register Value JSON File.....	27
34	HDC1010 GUI Configuration Page	28
35	Selecting the Measurement Units for the Data Streaming Graph	29
36	Data Streaming Graph Showing Only Relative Humidity Percent	30
37	Data Streaming Graph Showing Only Temperature	30
38	Select Log File Button on Data Streaming Page.....	31
39	Selecting the Log File for Data Streaming	32
40	Show Graph Configuration Button on Data Streaming Page.....	33
41	Setting the Data Streaming Sample Rate to 1 Second	33
42	Manually Setting the Vertical Scale on Data Streaming Graph	34
43	Starting Data Acquisition on Data Streaming Graph	35
44	Data Acquisition In Progress on Data Streaming Page	35
45	Stopping Data Acquisition on Data Streaming Graph	36
46	Show Statistics Button on Data Streaming Graph	37
47	Data Statistics on Data Streaming Graph.....	37

48	Moving the Data Graph Sample View	38
49	Viewing the Entire Buffer on Data Graph	39
50	Select TI-TXT File Button on Firmware Upload Page	40
51	Selecting TI-TXT Firmware File for Upload to EVM	40
52	Upload Firmware Button on Firmware Upload Page	41
53	Firmware Upload in Progress.....	41
54	Firmware Upload Success	42
55	Top Layer Routing	43
56	Bottom Layer Routing.....	43
57	HDC1010EVM Schematic.....	44

List of Tables

1	Device and Package Configurations	6
2	I2C Address	8

HDC1010EVM User's Guide

1 Introduction

The Texas Instruments HDC1010EVM evaluation module (EVM) enables designers to evaluate the operation and performance of the HDC1010 Relative Humidity and Temperature sensor.

The EVM contains one HDC1010 (See [Table 1](#)).

Table 1. Device and Package Configurations

DEVICE	IC	PACKAGE
U1	HDC1010YPAR	DSBGA - 8 pin (YPA0008)

The EVM hosts an MSP430F5528 microcontroller (μC) as well as the HDC1010. The μC is used to control the HDC1010 and communicate with a host PC through a USB port. The EVM is designed to be broken into two sections if desired. The sensor section can be separated from the μC section so that the user can remotely locate the sensor from the μC section.

2 Setup

This section describes the connectors on the EVM as well and how to properly connect, setup and use the HDC1010EVM.

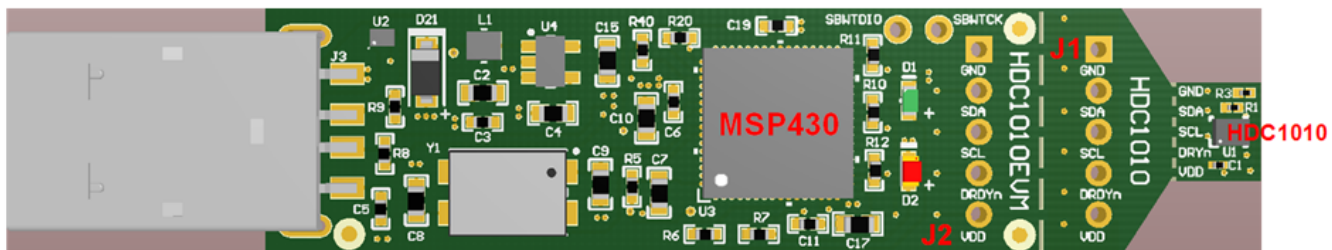

Figure 1. HDC1010EVM

2.1 Input/Output Connector Description

2.1.1 J1 – 5x1 Header

This header is not populated and can be installed if the EVM is broken in 2 sections: PC interface and Sensor. This connector with its counterpart J2 allows the communication of the two sections through a 5-wire cable

J1.1	GND
J1.2	SDA
J1.3	SCL
J1.4	DRDYn
J1.5	VDD

2.1.2 J2 – 5x1 Header

This header is not populated and can be installed if the EVM is broken in 2 sections: PC interface and Sensor. This connector with its counterpart J1 allows the communication of the two sections through a 5-wire cable.

J2.1	GND
J2.2	SDA
J2.3	SCL
J2.4	DRDYn
J2.5	VDD

2.1.3 USB Type A Connector

This connector is used for communications with the PC and provides power for the EVM.

2.2 Hardware Setup

The HDC1010EVM power is supplied via the USB connector. The LDO (U4) converts the 5V from the USB to 3.3V used by the HDC1010 and the MSP430. The EVM may be directly inserted into a USB port on a PC or laptop, or may be connected to the latter using the appropriate USB cable.

The I2C address of the HDC1010 is set at EVM level at 1000000xb on the EVM. The I2C address has been set mounting the 0 Ω resistors R3 and R1 (refer to [Figure 2](#)).

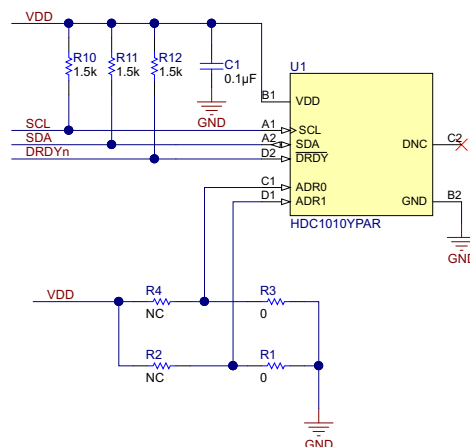

Copyright © 2016, Texas Instruments Incorporated

Figure 2. HDC1010EVM : Sensor module

In order to change the I2C address, remove the resistors R1 and R3 and populate the R2 and R4 with 0 Ω resistors (refer to Figure 3 and Figure 4)

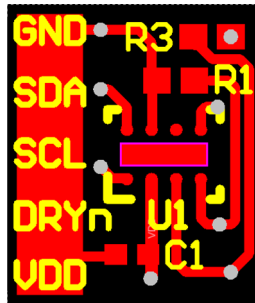

Figure 3. HDC1010EVM: Layout Resistors for I2C Address Setting - Top

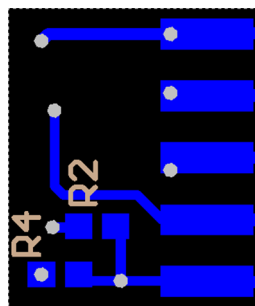

Figure 4. HDC1010EVM: Layout Resistors for I2C Address Setting - Bottom

Table 2. I2C Address

ADR1	ADR0	R1	R2	R3	R4	HDC1010 ADDRESS
0	0	Short	Open	Short	Open	1000000
0	1	Open	Short	Short	Open	1000001
1	0	Short	Open	Open	Short	1000010
1	1	Open	Short	Open	Short	1000011

In the table above, the EVM default configuration is in **bold**.

2.3 Software Setup

2.3.1 System Requirements

The Sensing Solutions GUI supports:

- 64-bit Windows 7
- 64-bit Windows XP

The current GUI does not support 32-bit Windows operating systems. The host machine is required for device configuration and data streaming. The following steps are necessary to prepare the EVM for the GUI:

- The GUI and EVM driver must be installed on the host.
- The EVM must be connected to a full speed USB port (USB 1.0 or above).

2.3.2 Sensing Solutions GUI and EVM Driver Installation

The Sensing Solutions GUI and EVM driver installer is packaged in a zip file. Follow these steps to install the software.

1. Download the software ZIP file from the EVM tool page
2. Extract the downloaded ZIP file
3. Run the included executable
4. Follow all directions from the installer

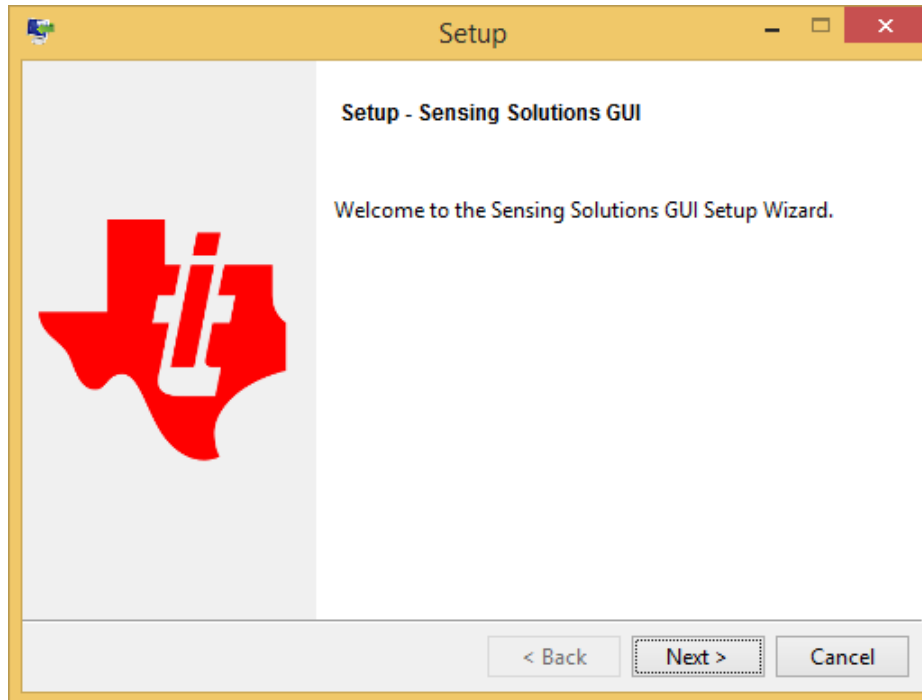

Figure 5. GUI Installer Welcome Page

5. Read the license agreement and if you still wish to install the software, select “I accept the agreement” and click “Next” as shown in

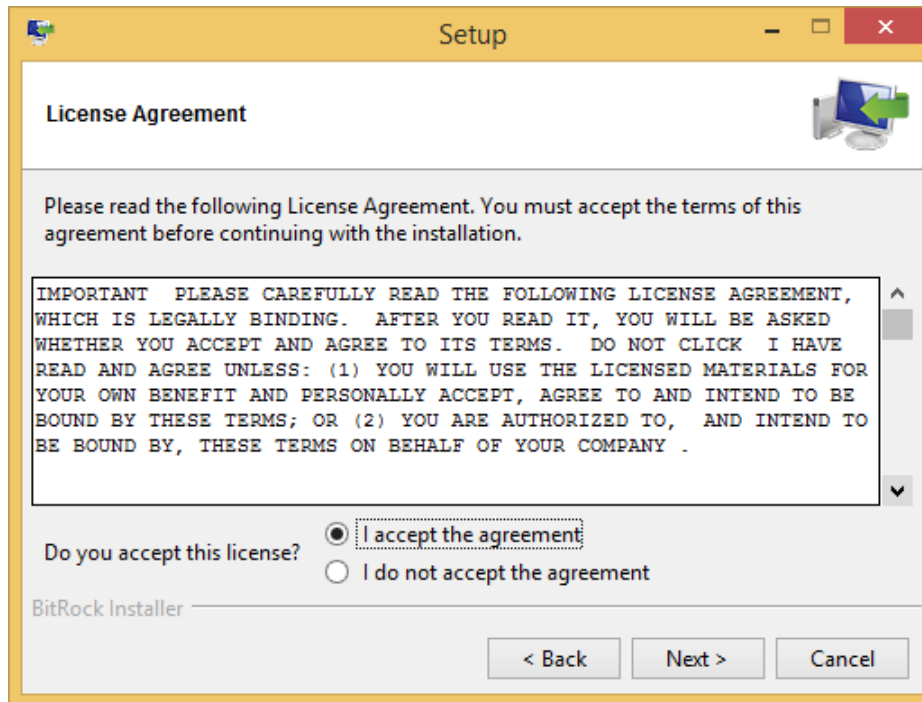

Figure 6. GUI Installer License Agreement

6. Select the installation directory. If the user installing the software is not a system administrator a directory not with “Program Files” should be chosen instead of the default.

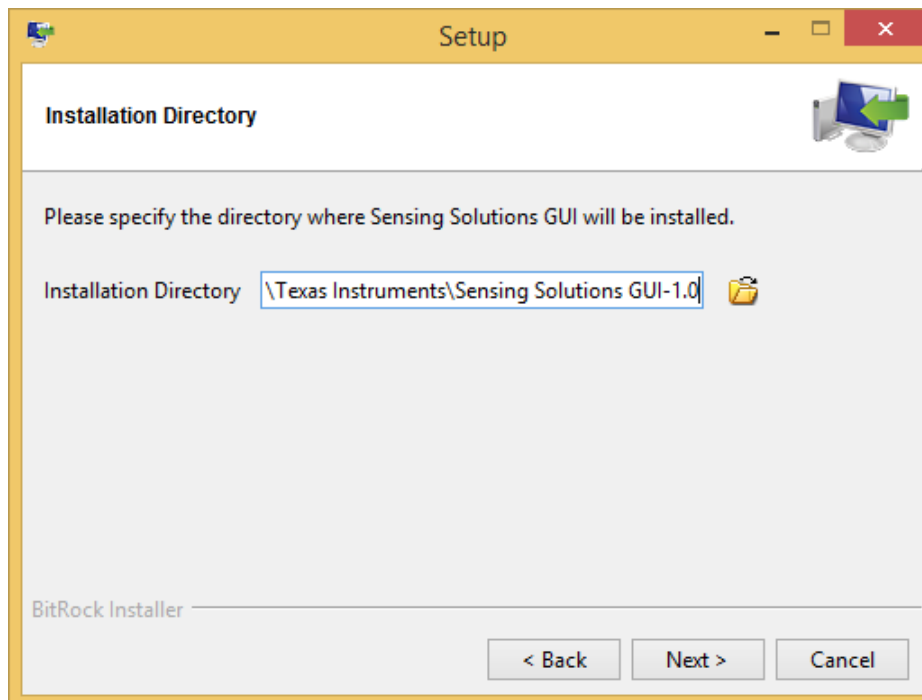

Figure 7. GUI Installer Installation Directory

7. Wait for all files to install

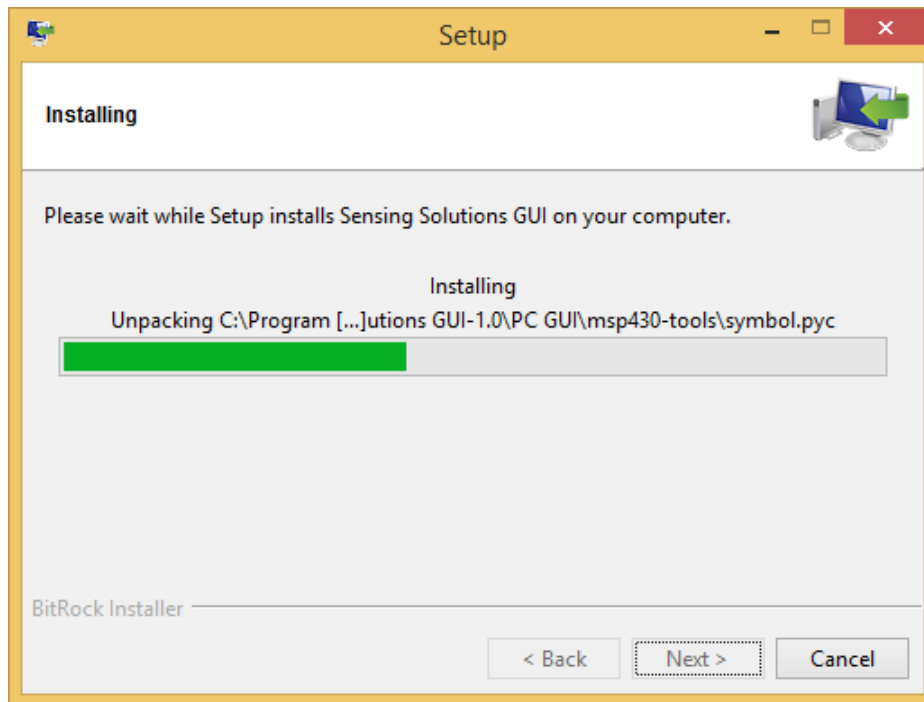

Figure 8. GUI Installer Copying Files

8. After the files have copied a device driver installer will start. If prompted about an unsigned driver, choose to install the driver anyways. If running Windows 8 or 8.1, the PC must be started in a “Safe” mode to install the unsigned driver.

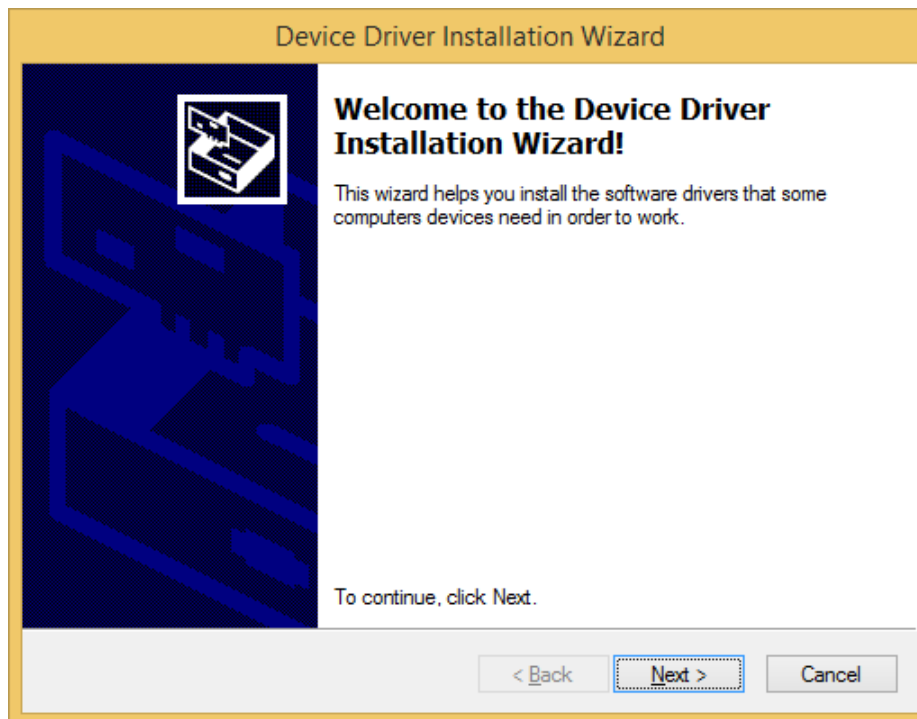

Figure 9. EVM Driver Installer Welcome Page

9. Wait for the driver to install

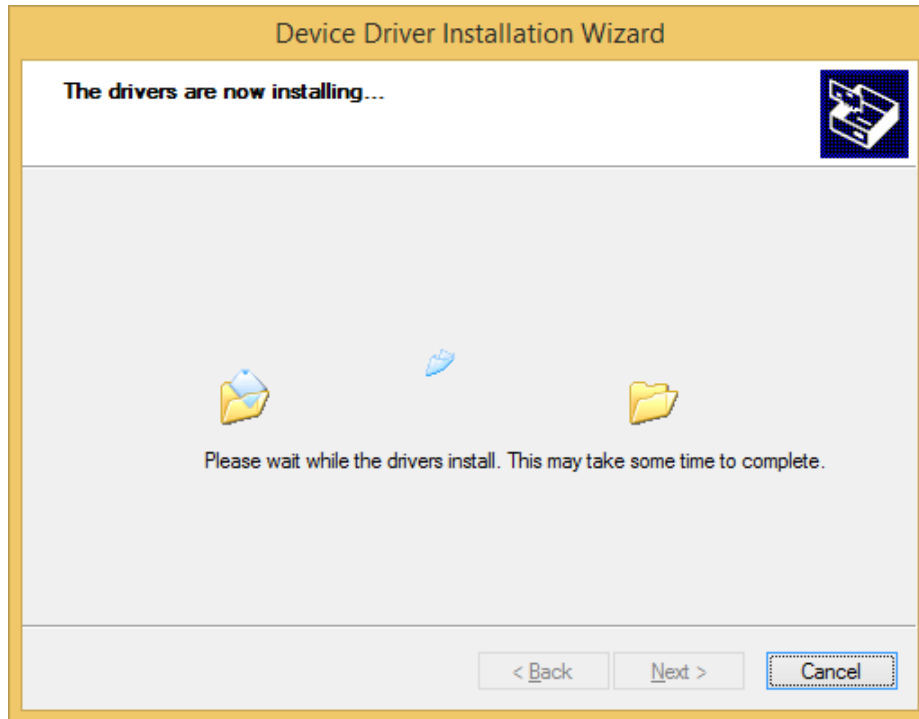

Figure 10. EVM Driver Installer In Progress

10. Click "Finish" after the driver has been installed

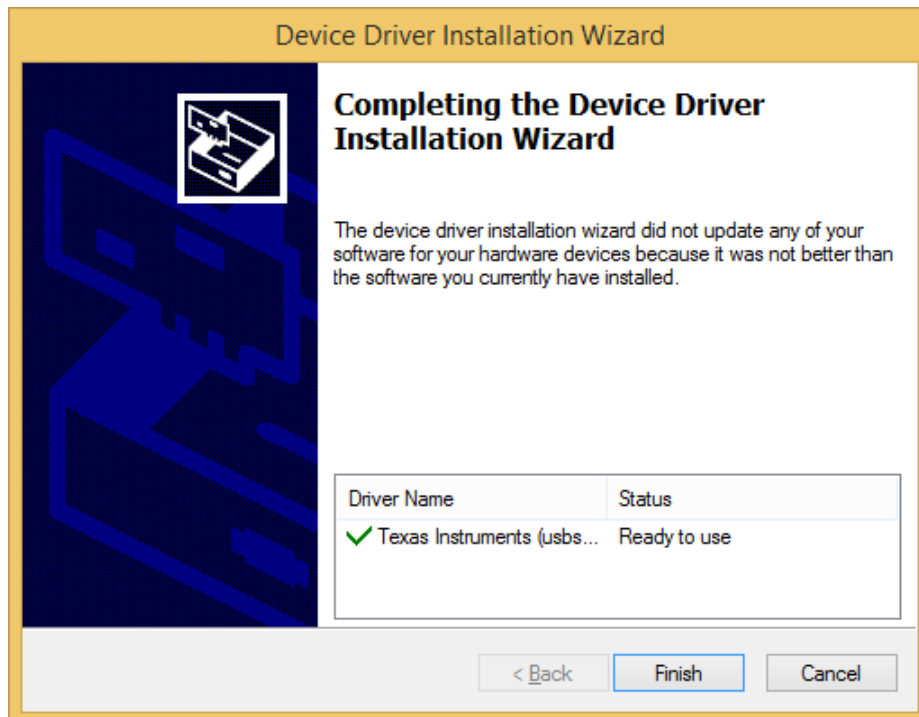

Figure 11. EVM Driver Installer Complete

11. Click "Finish" to complete the software installation

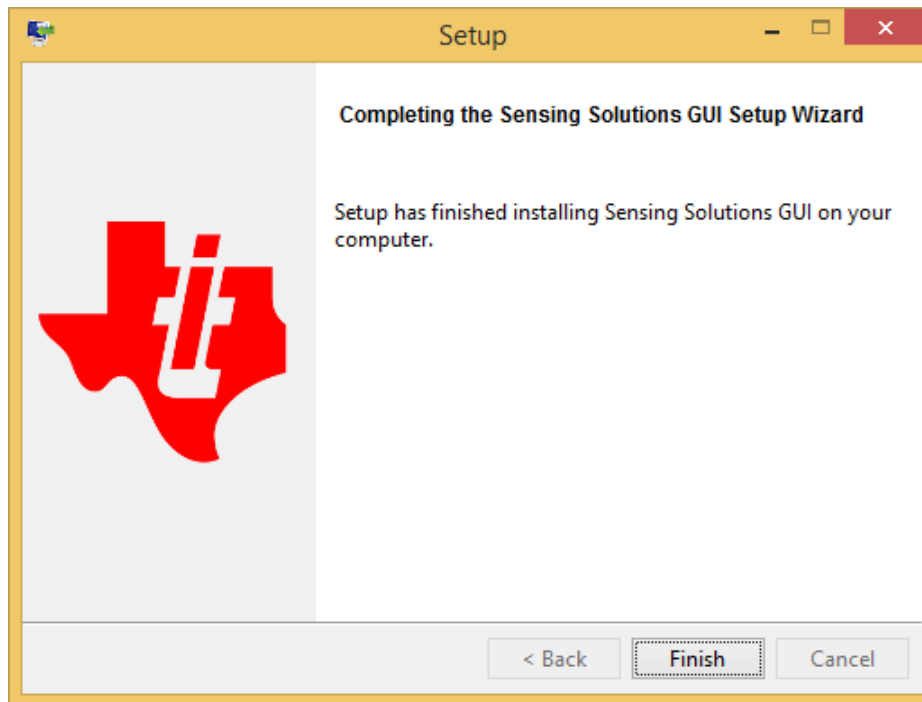

Figure 12. GUI Installer Complete

2.4 Operation

When the EVM is connected to the host computer, the latter should automatically detect the device as an HDC1080EVM/HDC1000EVM.

Launch the GUI. A detailed description of the GUI operation is presented later in this document.

2.5 Reducing the Sensor Thermal Mass

The HDC1010EVM can be broken into 2 sections to isolate the thermal mass of the μC from the HDC1010. [Figure 13](#) shows the board perforations that allow the two sections to be broken apart.

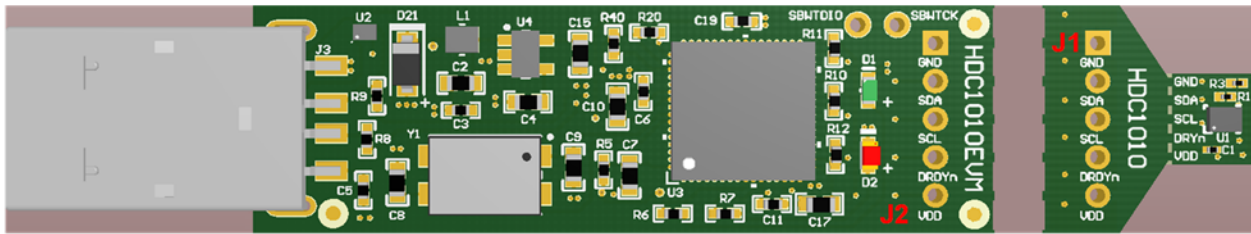

Figure 13. HDC1010EVM : PC Interface and Sensor Module

The communication between the two modules is ensured through the connector J1 and J2 and a 5-wire cable. In this configuration the thermal mass of the EVM is dramatically reduced, improving the temperature measurements performances of the HDC1010. The cable connecting J1 to J2 must conform to I2C cable length constraints. When used in this configuration, the GUI can still be used to communicate with the EVM and collect data.

If the thermal mass of the sensor section is still excessive, the sensor section can be reduced by breaking it at the perforation shown in [Figure 14](#). The PCB segment that hosts the HDC1010 is 5.5mm x 5mm.

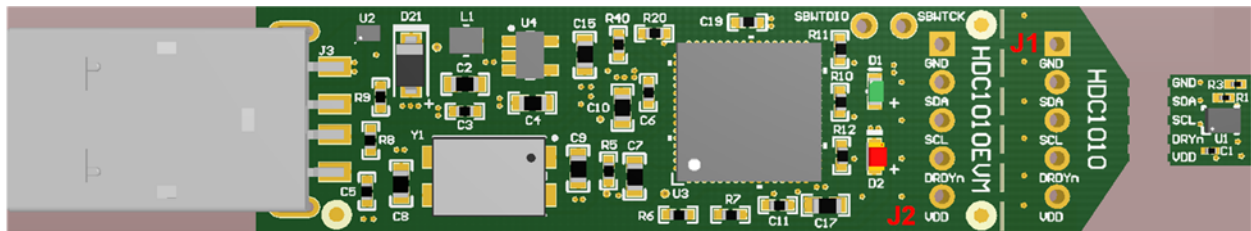

Figure 14. HDC1010EVM : PC Interface and Smaller Sensor Module

Also in the case where the EVM is broken in 2 sections it is still possible to use the GUI (ensuring the connections between the modules) or alternatively it is possible to connect the sensor module to a custom micro-controller. (Refer to [Figure 15](#)).

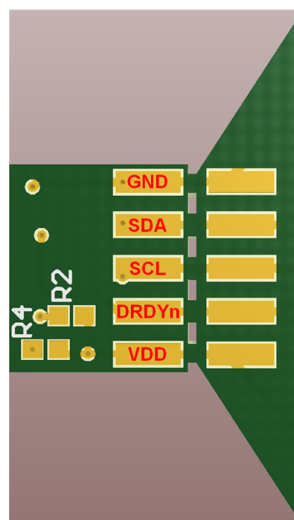

Figure 15. HDC1010EVM : Pads for I2C and Supply of the Smaller Sensor Module

3 GUI Operation

The section describes how to use the GUI

3.1 *Starting the GUI*

Follow these steps to start the GUI:

1. Select the windows start menu
2. Select "All programs"
3. Select the "Texas Instruments" folder
4. Select the Sensing Solutions GUI
5. Click "Sensing Solutions GUI"
6. Splash screen will appear for at least two seconds.
 - Slower PC's may show a blank splash screen without any texts for up to 20 seconds

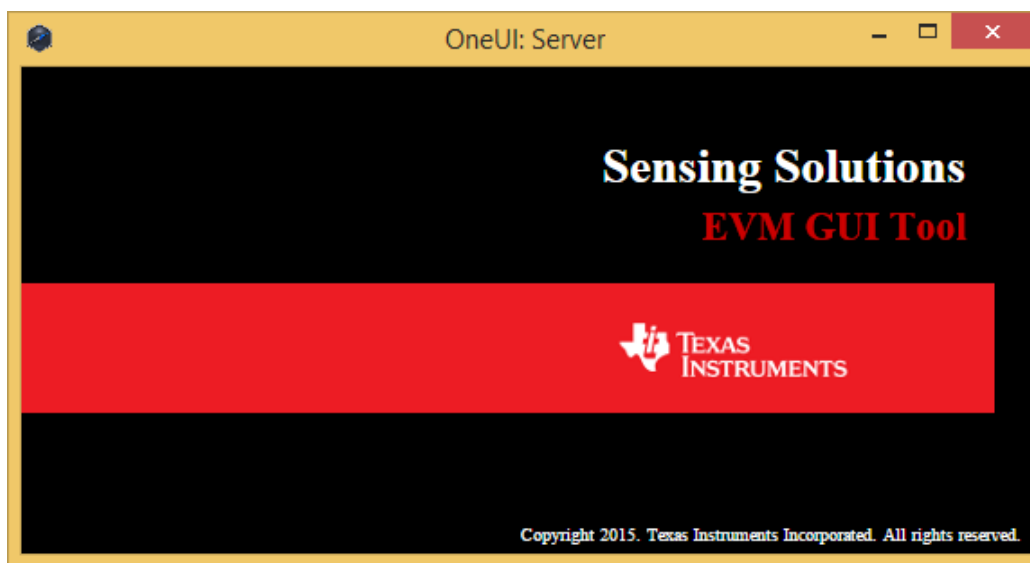

Figure 16. GUI Splash Screen

7. After the splash screen is displayed the main window will open. Note: Only one instance of the GUI may be open at a time!

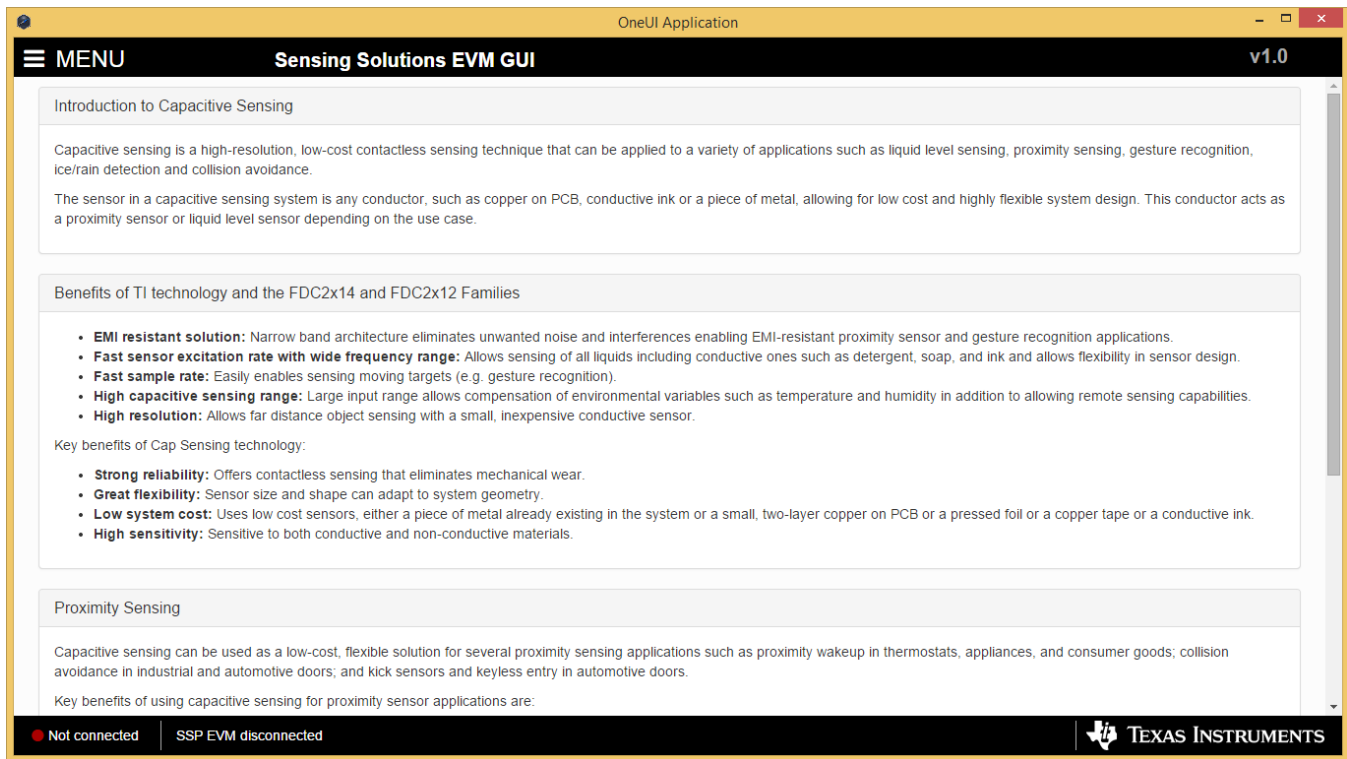

Figure 17. GUI Introduction Page

3.2 Connecting the EVM

Follow these steps to connect the EVM to the GUI:

1. Attach the EVM to the computer via the USB port.
2. The GUI always shows the connection status on the bottom left corner of the GUI
 - The initial release of this GUI does not support multiple GUI instances or multiple devices. To control multiple EVMs, virtual machines may be used or multiple PC's are required. Future releases will support multiple EVMs from a single instance of the GUI.

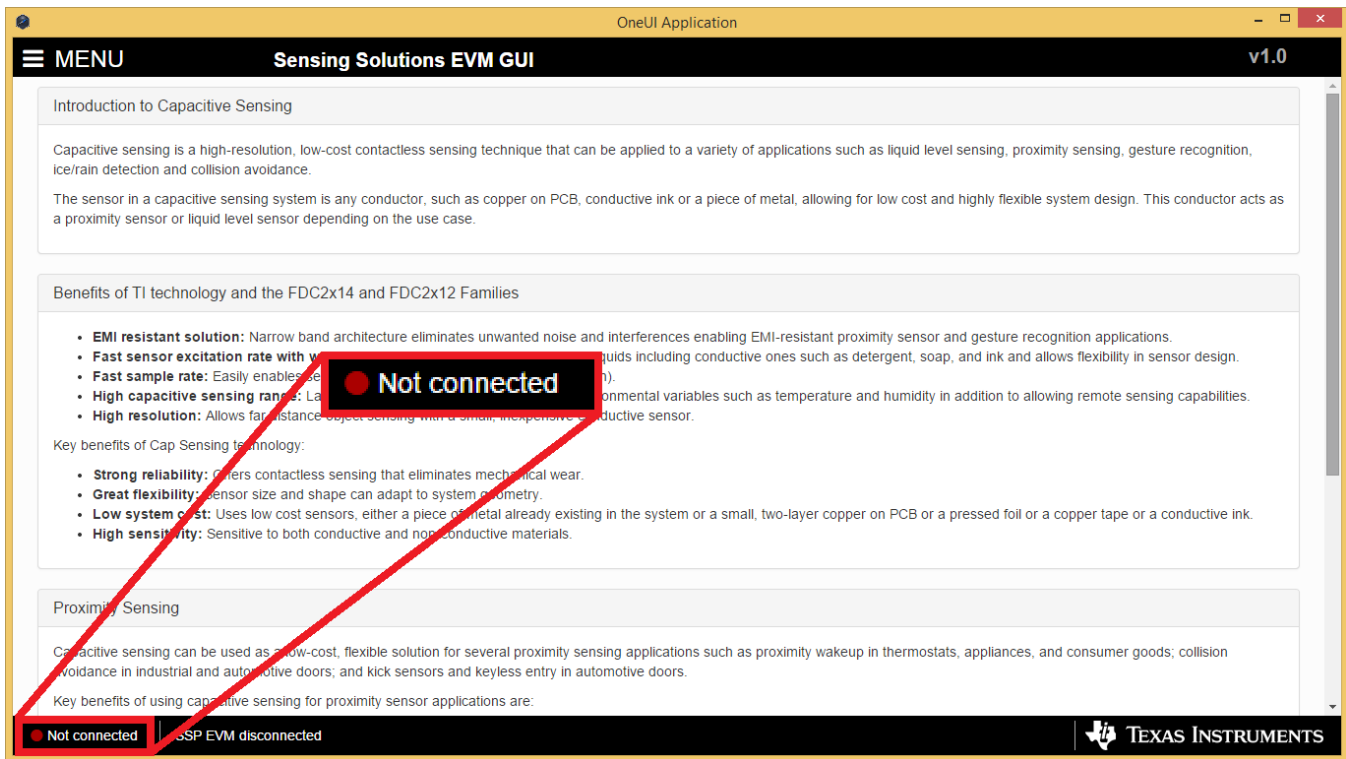

Figure 18. GUI Disconnected From EVM

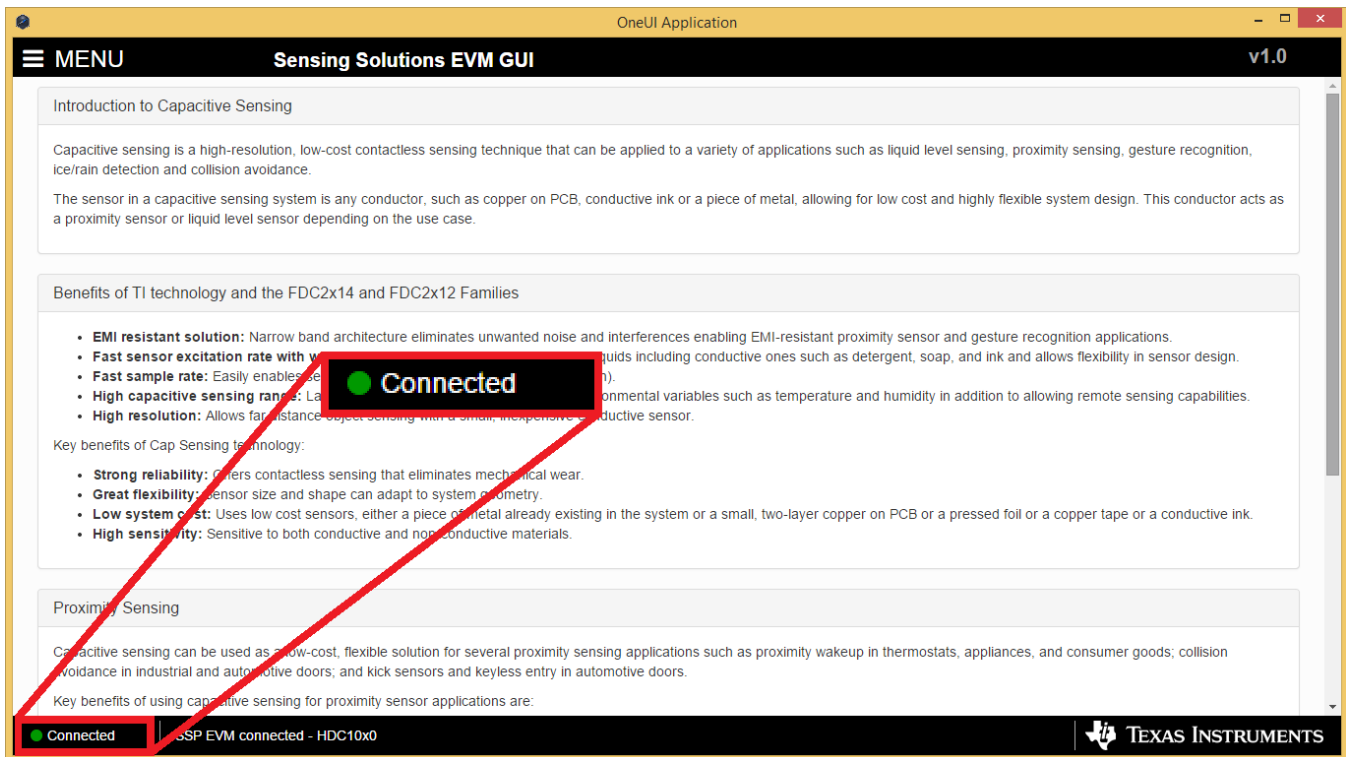

Figure 19. GUI Connected from EVM

3.3 Navigating the GUI

To navigate to different pages of the GUI follow these steps:

1. Click “Menu” in the upper left corner

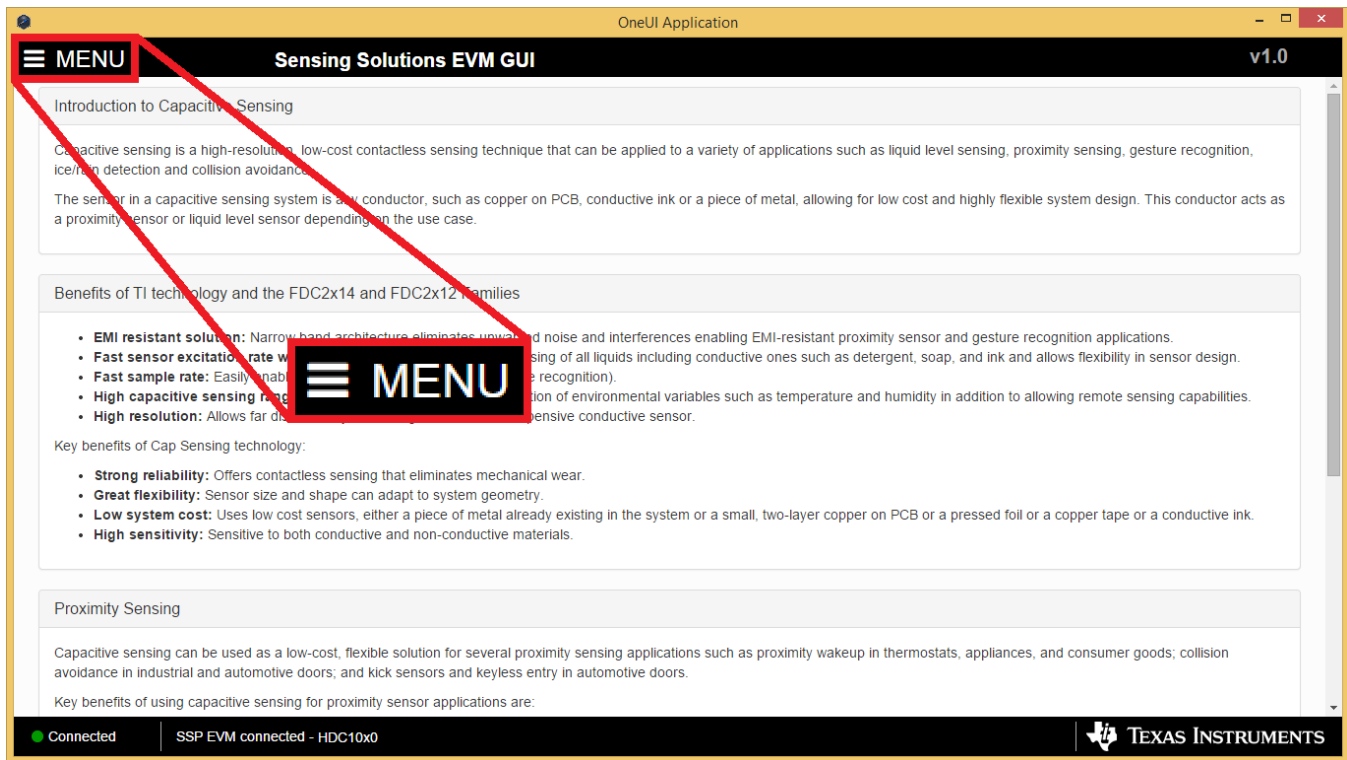

Figure 20. GUI Menu Button

2. Select the desired page from the menu shown on the left

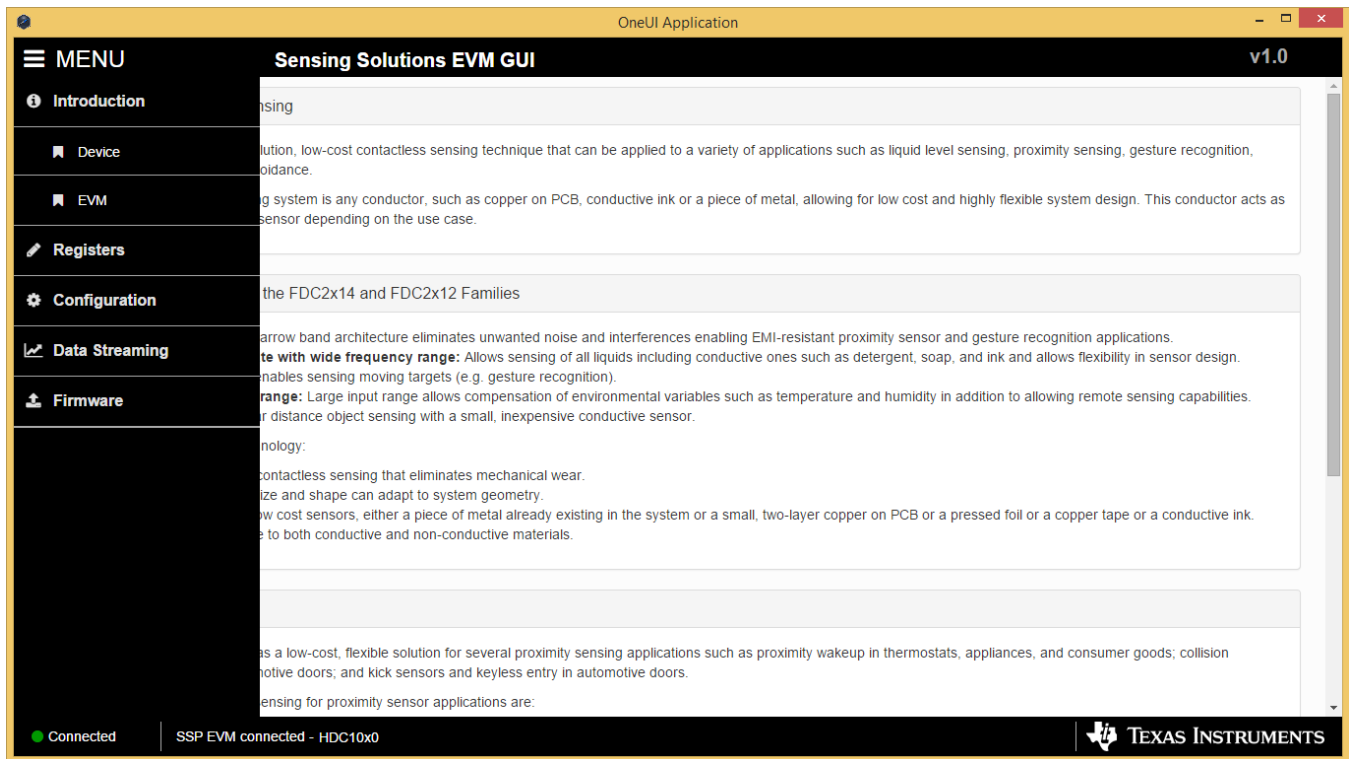

Figure 21. GUI Navigation Menu

3.4 Configuring the Device using Register Page

The register page allows users to control the device directly with the register values. The user may also use this page to read the current register values on the device.

3.4.1 Automatically Updating GUI Register Values Using Auto-Read

Autoread will periodically request the register values on the device. Click the dropdown box next to "Auto Read" to select the update interval.

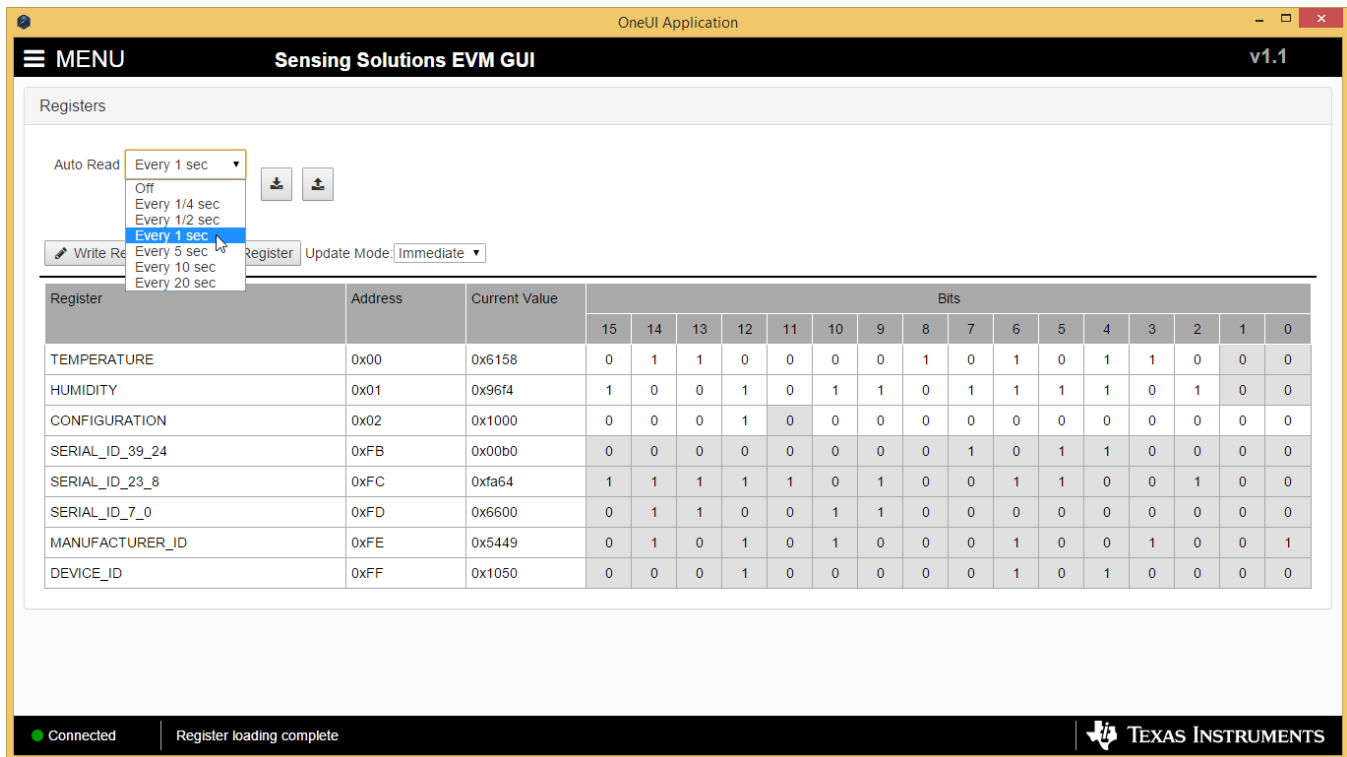

Figure 22. Selecting Auto-Read Interval on Register Page

3.4.2 Manually Updating Device Register Values

There are two methods to change register values: update the entire register value or change a single bit within the register. The recommended update mode is always “Immediate” and not “Deferred”. To update register values, follow these steps.

1. Double-click the current value of the register that needs to be changed. The text will turn into an editable text box

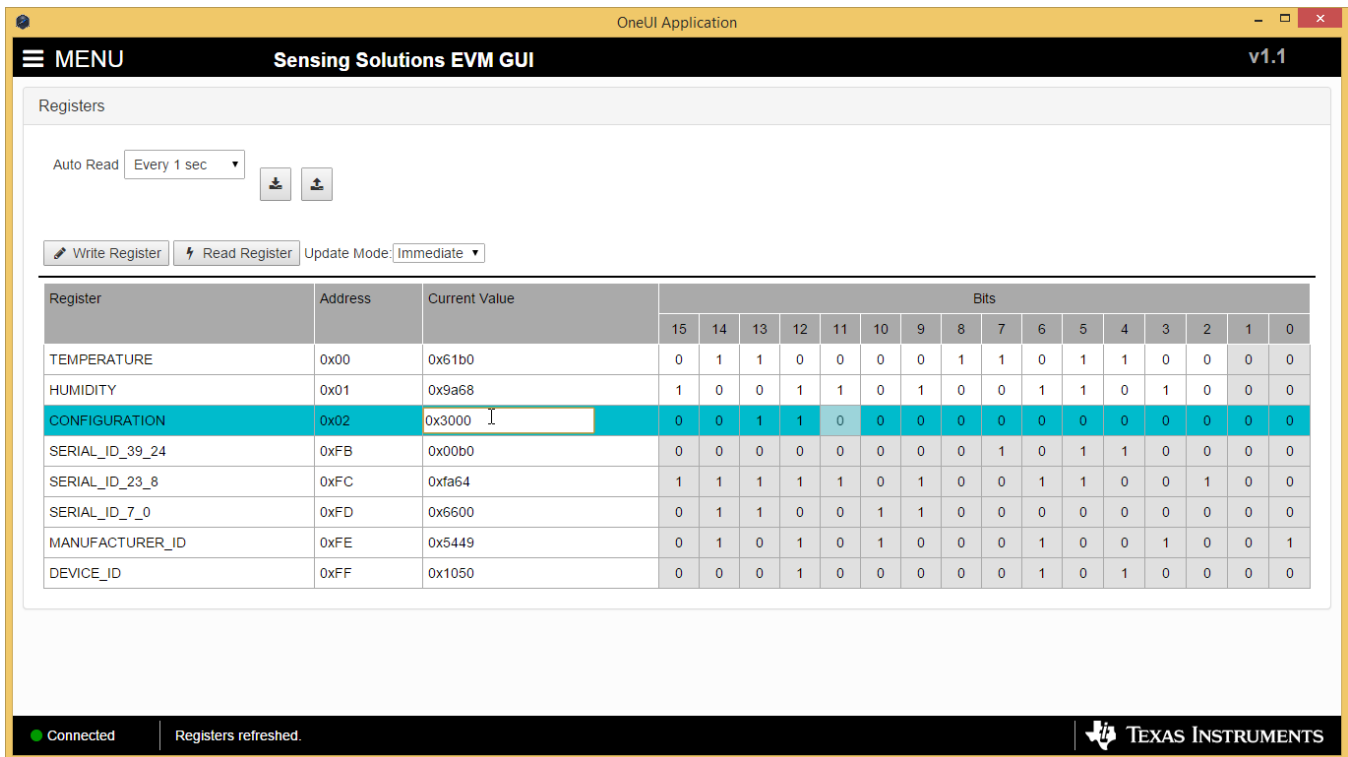

Figure 23. Selecting a Register's Current Value for Editing on Register Page

2. Type the new value in hexadecimal into the box and click enter. The text box changes to normal text and the GUI will send a command to the EVM to update the device register

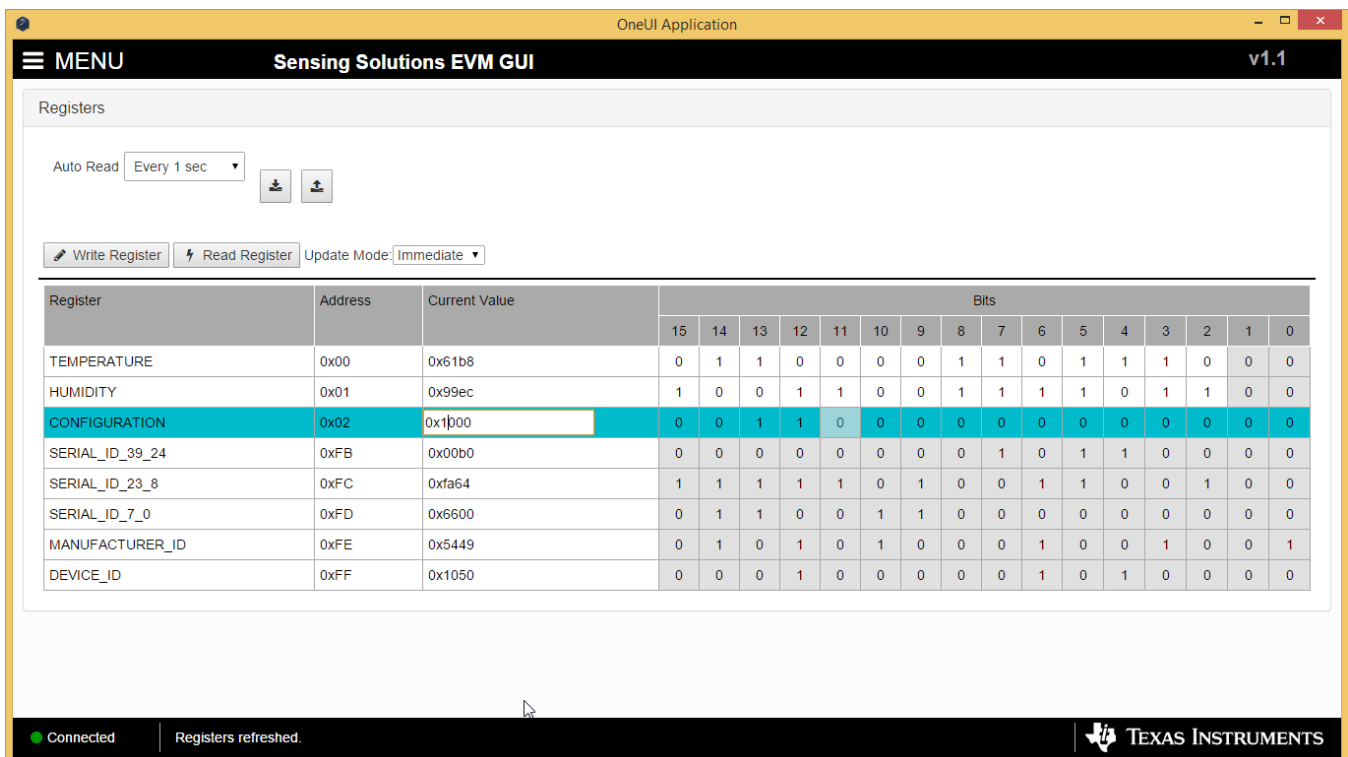

Figure 24. Entering New Value for Register on Register Page

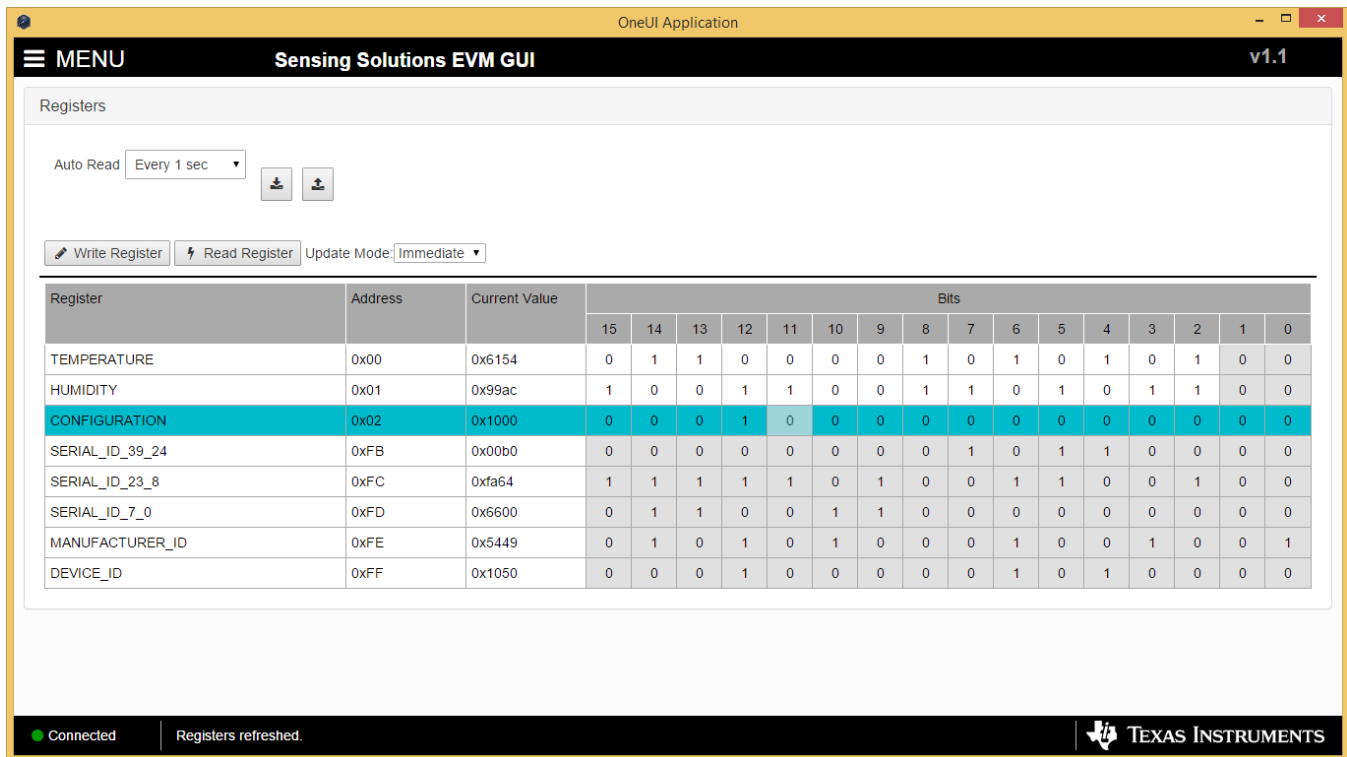

Figure 25. Register Value Updated After Changing Value on Register Page

To change individual bit values rather than entire register values follow these steps.

1. Hover the mouse over the desired bit to change

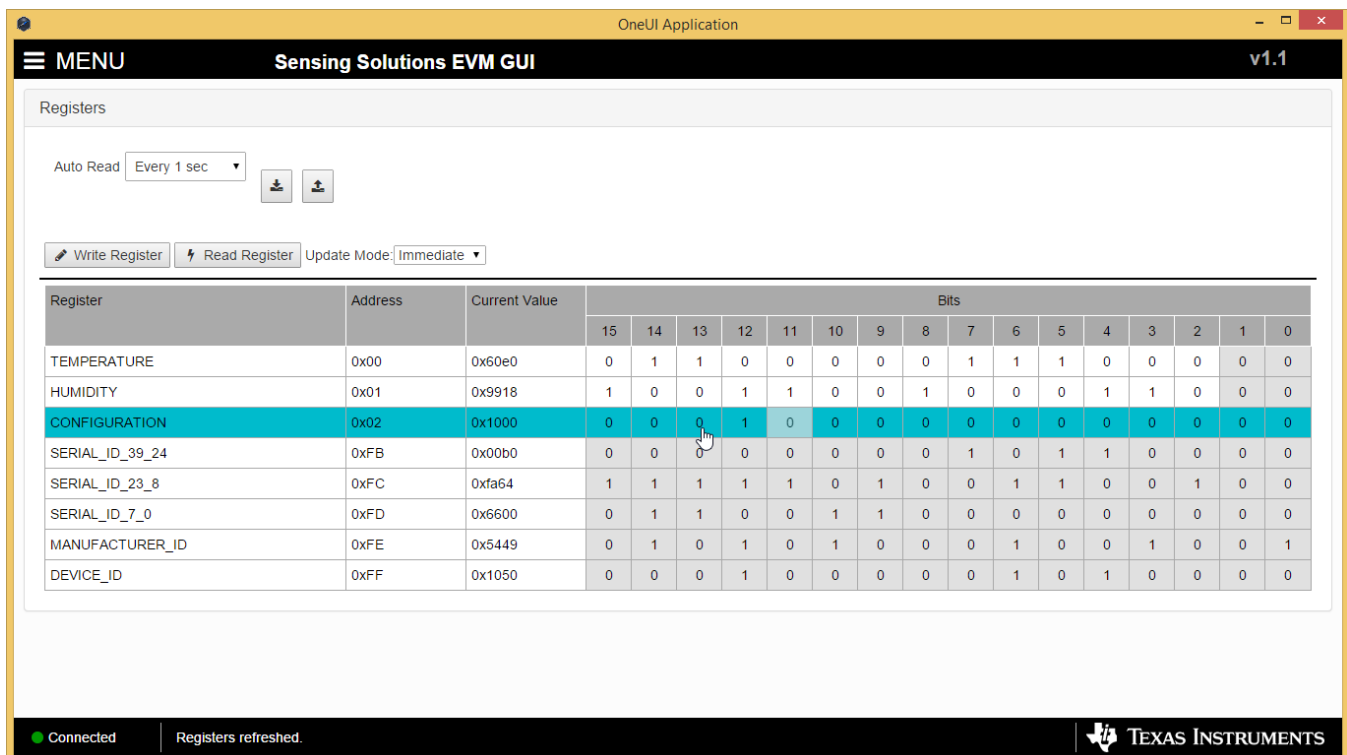
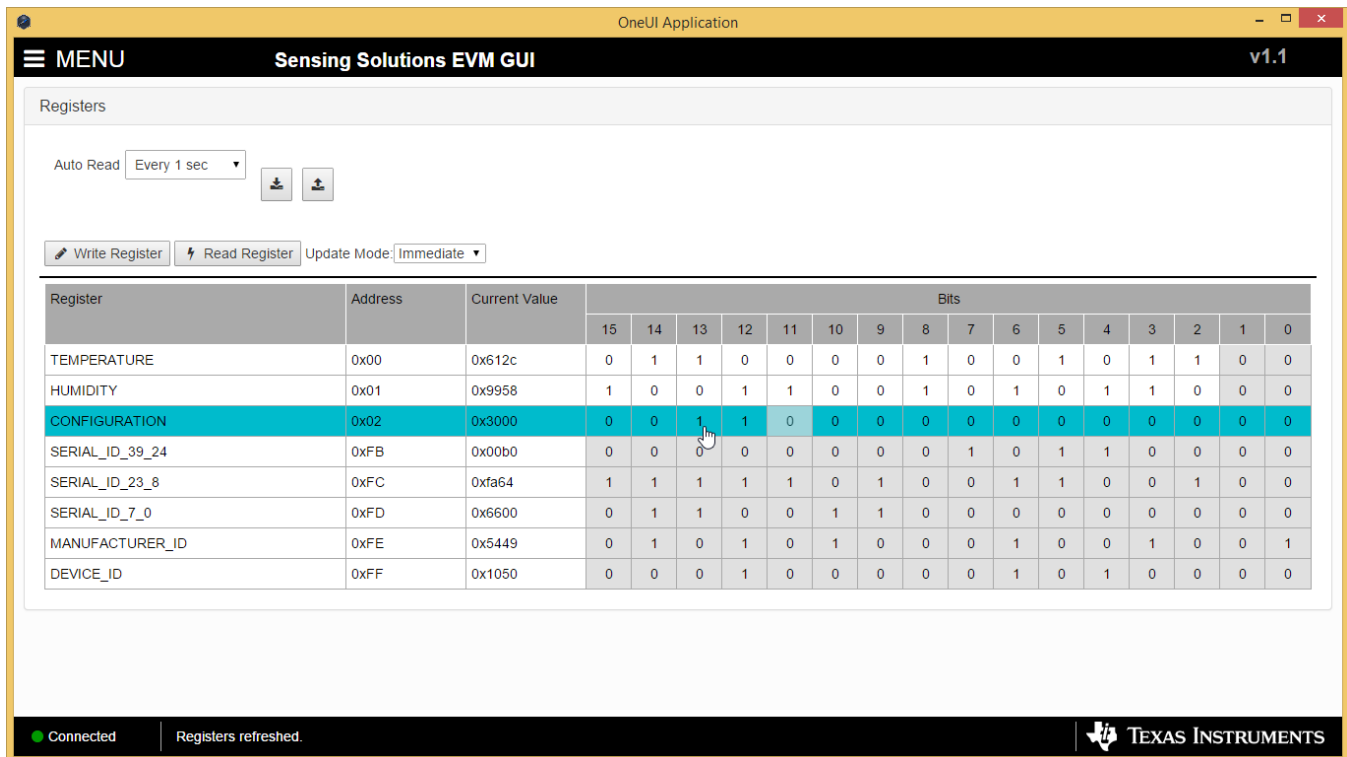

Figure 26. Hovering Mouse Over Register Bit Value on Register Page

2. Double-click the bit to toggle its value and the register's current value will update automatically



The screenshot shows the 'Sensing Solutions EVM GUI' window. At the top, there is a 'MENU' button and the version 'v1.1'. Below the title bar, there are controls for 'Auto Read' (set to 'Every 1 sec'), 'Write Register', 'Read Register', and 'Update Mode' (set to 'Immediate'). The main area contains a table of registers with columns for 'Register', 'Address', 'Current Value', and 'Bits' (15 to 0). The 'CONFIGURATION' register (Address 0x02, Current Value 0x3000) is highlighted in blue. A mouse cursor is hovering over the bit 13 column of the CONFIGURATION row, which currently shows a '1'. The status bar at the bottom indicates 'Connected' and 'Registers refreshed.', along with the Texas Instruments logo.

Register	Address	Current Value	Bits																
			15	14	13	12	11	10	9	8	7	6	5	4	3	2	1	0	
TEMPERATURE	0x00	0x612c	0	1	1	0	0	0	0	0	1	0	0	1	0	1	1	0	0
HUMIDITY	0x01	0x9958	1	0	0	1	1	0	0	1	0	1	0	1	1	0	0	0	0
CONFIGURATION	0x02	0x3000	0	0	1	1	0	0	0	0	0	0	0	0	0	0	0	0	0
SERIAL_ID_39_24	0xFB	0x00b0	0	0	0	0	0	0	0	0	1	0	1	1	0	0	0	0	0
SERIAL_ID_23_8	0xFC	0xfa64	1	1	1	1	1	0	1	0	0	1	1	0	0	1	0	0	0
SERIAL_ID_7_0	0xFD	0x6600	0	1	1	0	0	1	1	0	0	0	0	0	0	0	0	0	0
MANUFACTURER_ID	0xFE	0x5449	0	1	0	1	0	1	0	0	0	1	0	0	1	0	0	0	1
DEVICE_ID	0xFF	0x1050	0	0	0	1	0	0	0	0	0	1	0	1	0	0	0	0	0

Figure 27. Toggling Register Bit Value on Register Page

3.4.3 Reading Register Values without Auto-Read

To read register values follow these steps.

1. Select the register to update by clicking any column of the register row in the table

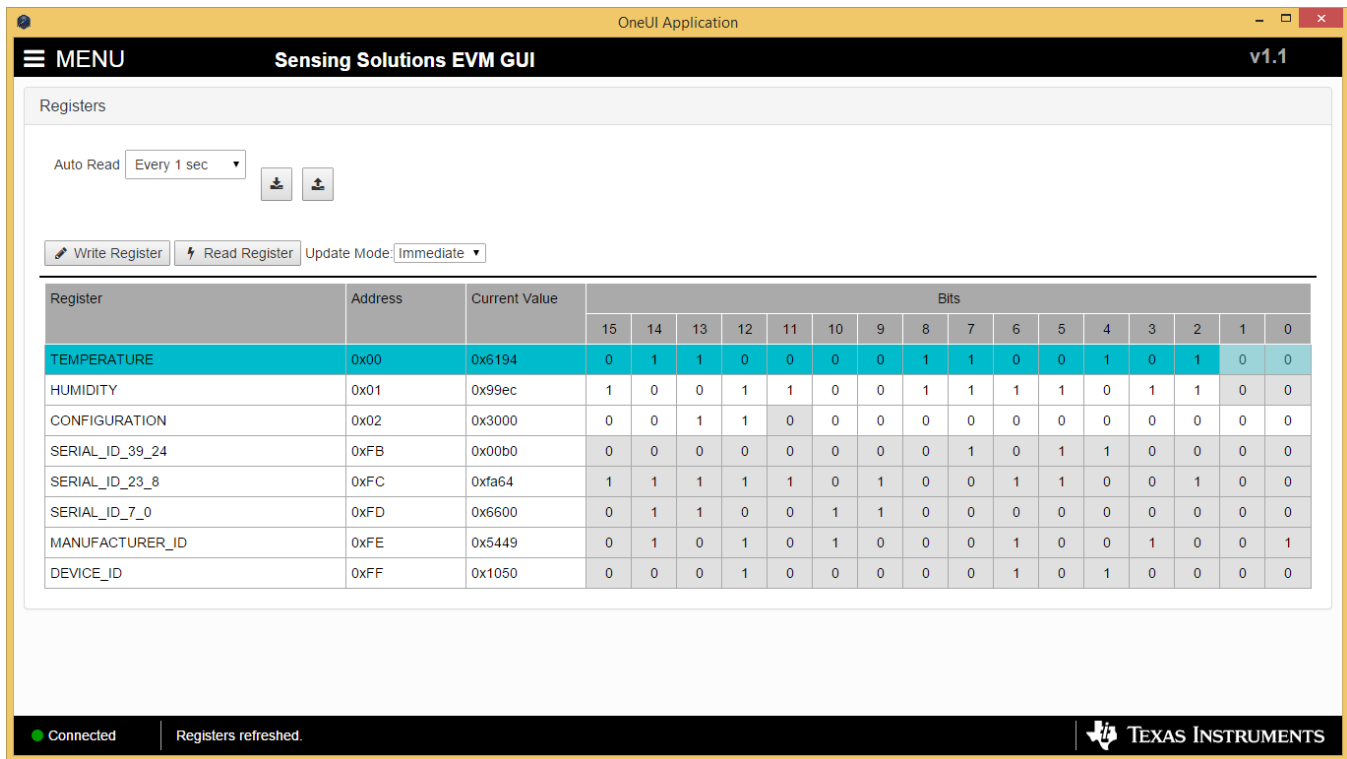

Figure 28. Selecting a Register on Register Page

2. Click the “Read Register” button to update the selected register’s current value and bit values in the table

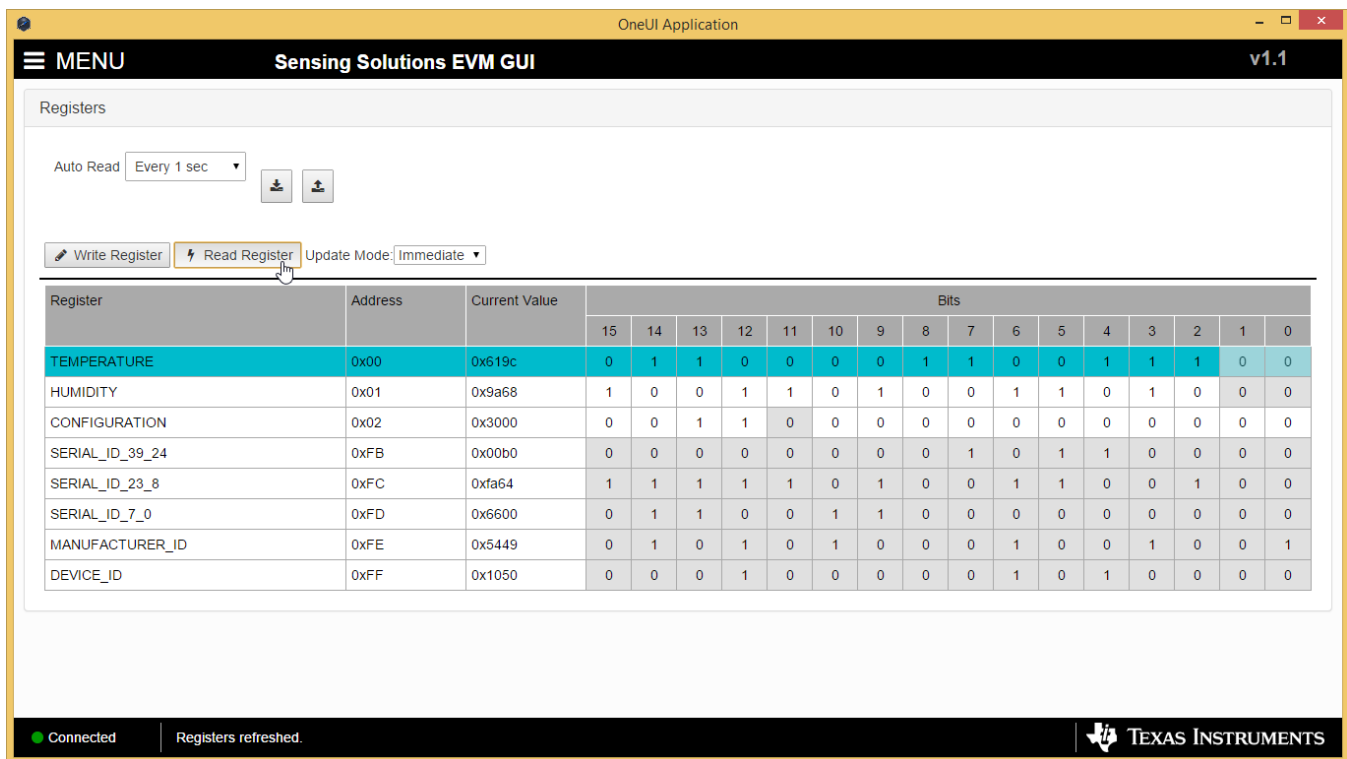

Figure 29. Reading the Current Device Register Value on Register Page

3.4.4 Saving Device Configuration

To save the current register settings of the device follow these steps.

1. Click the button immediately right to the “Auto-Read” selection dropdown

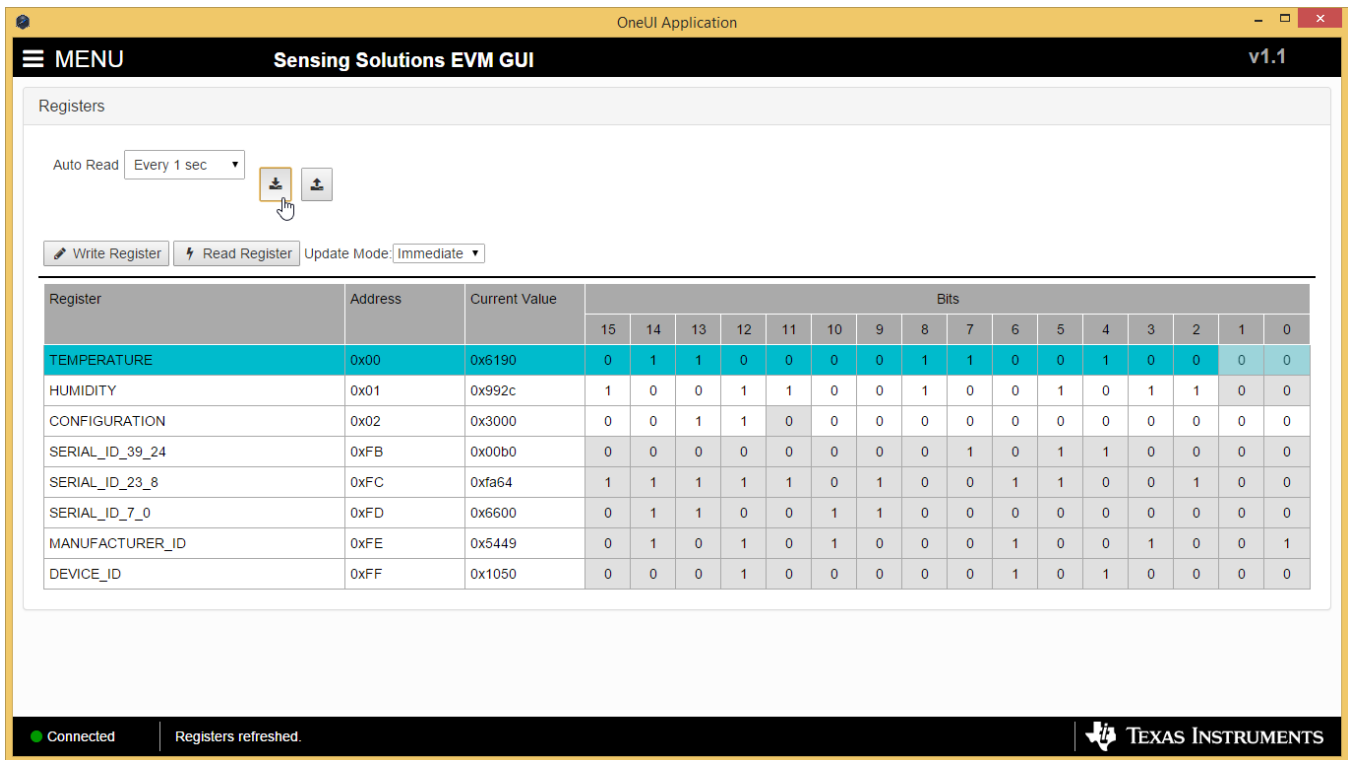

Figure 30. Save Register Values to File on Register Page

2. Choose a JSON file name and the directory to save it within. Then click “Save”

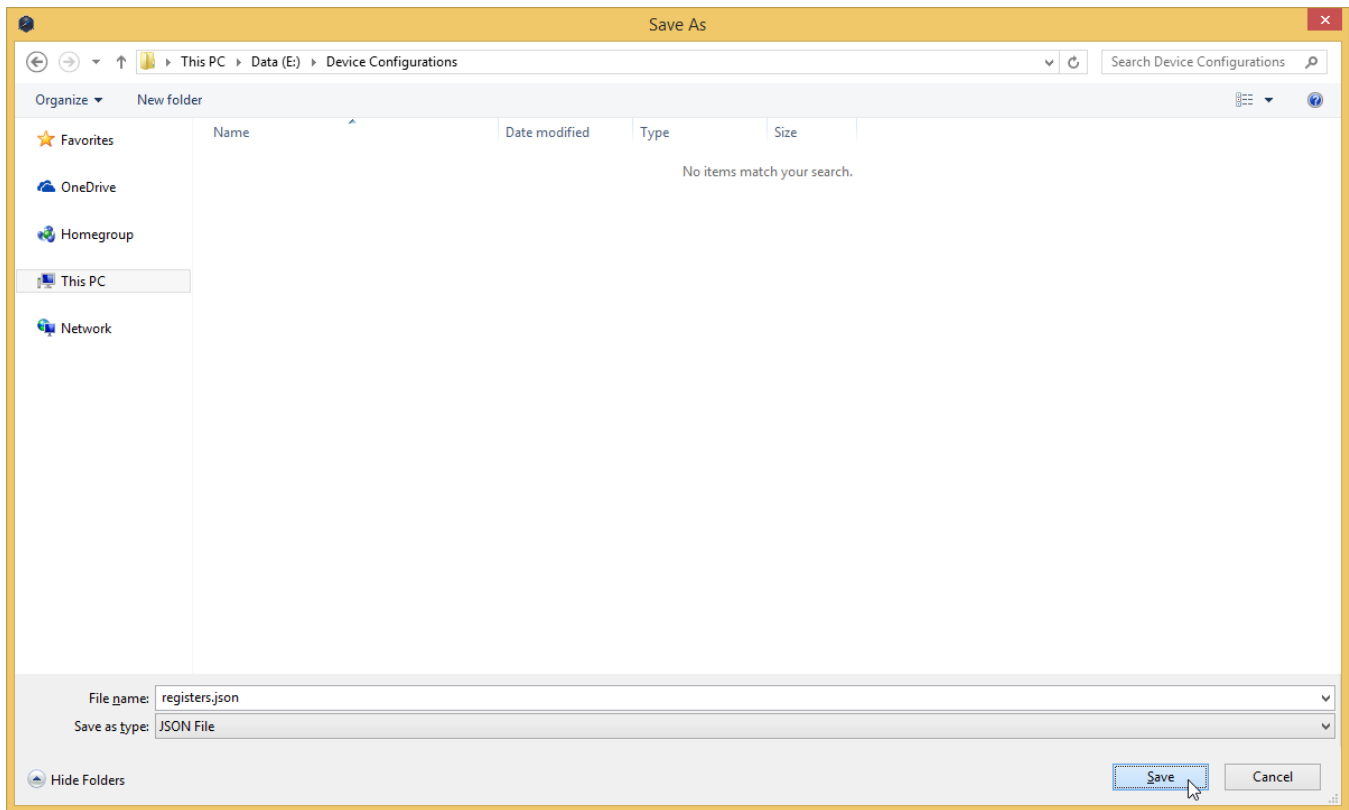

Figure 31. Choosing a JSON File Name to Save Register Values

3.4.5 Loading Previously Saved Device Configuration

To load previously saved register settings from a JSON file follow these steps.

1. Click the button furthest right from the “Auto-Read” selection dropdown

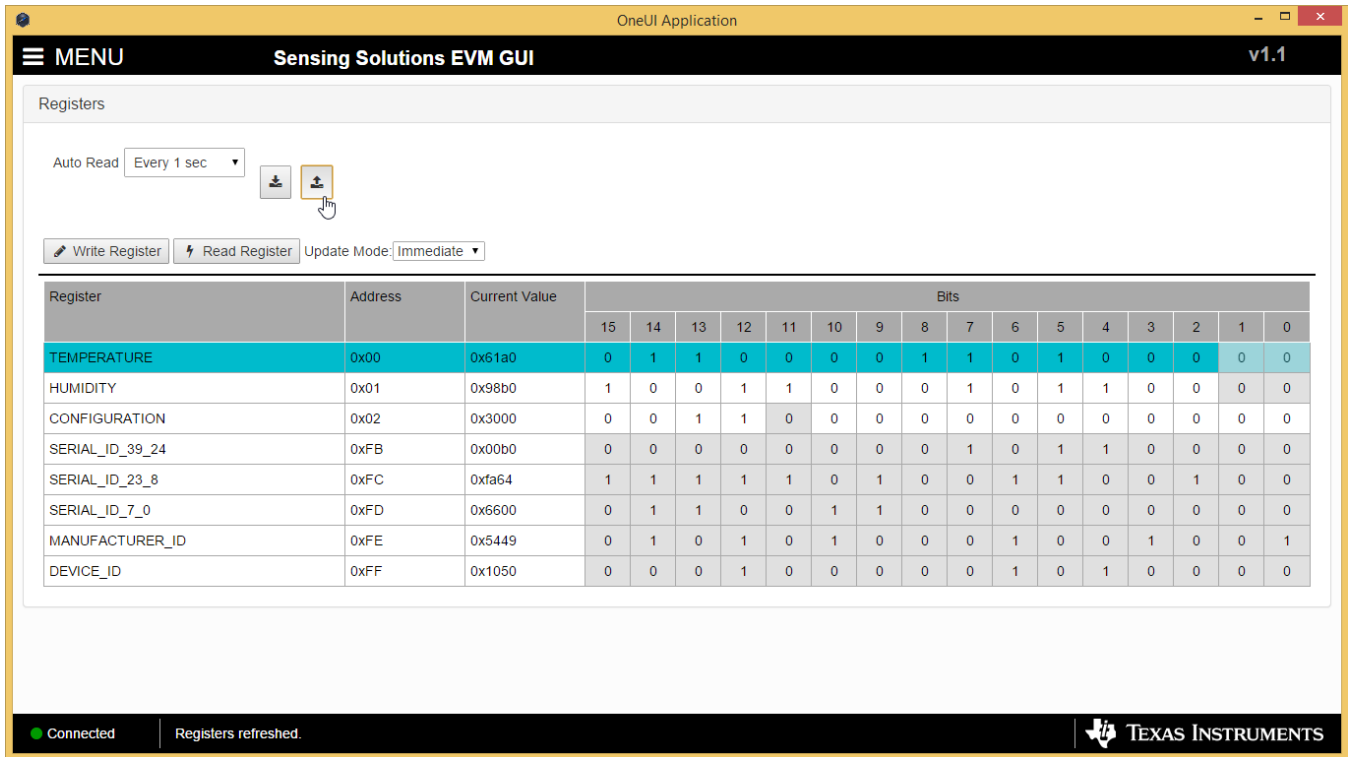

Figure 32. Loading Previously Saved Register Values from File on Register Page

2. Select the JSON file with the desired settings and click “Open”

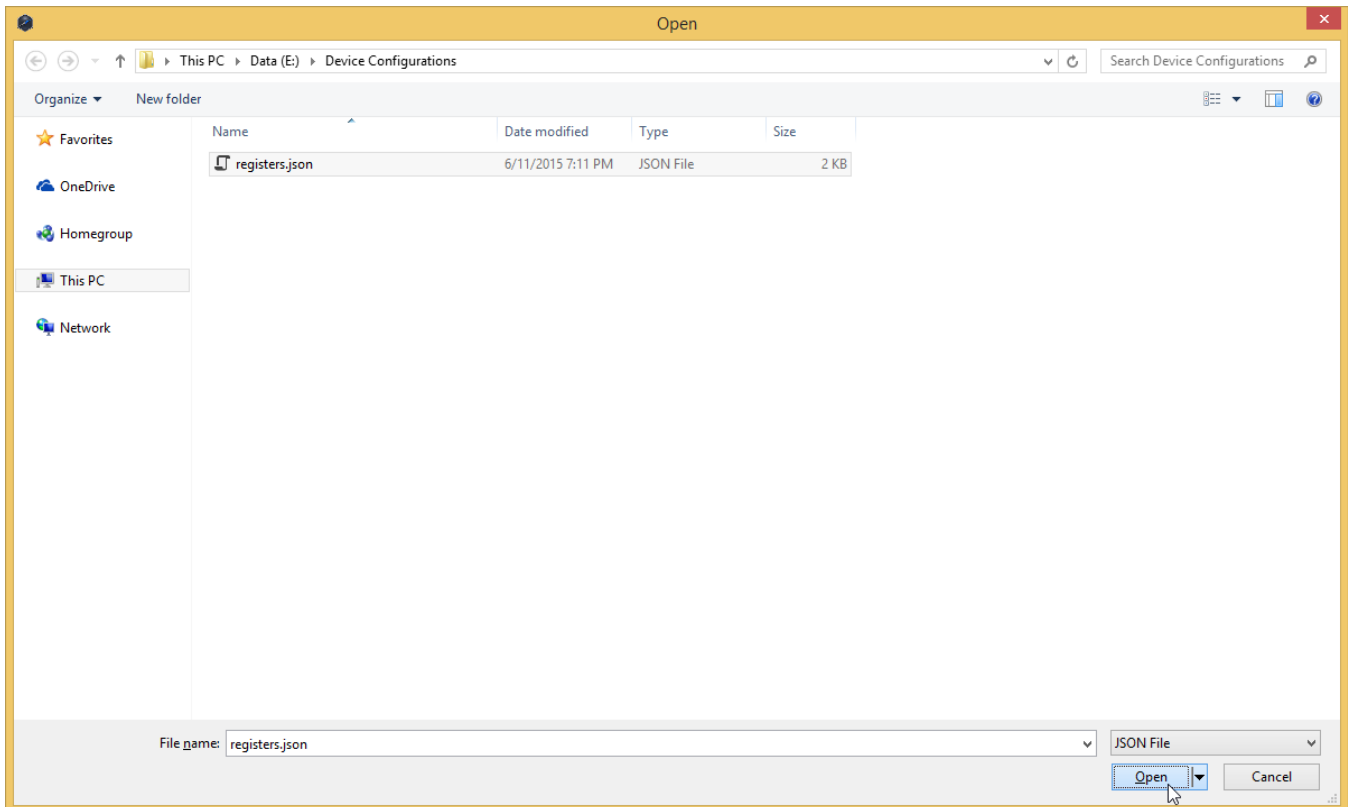

Figure 33. Selecting Previously Save Register Value JSON File

3.5 Configuring the Device using Configuration Page

The Sensing Solutions GUI is capable on configuring the device more intuitively than the direct register values. For more information about configuring the HDC1010 please reference the device datasheet.

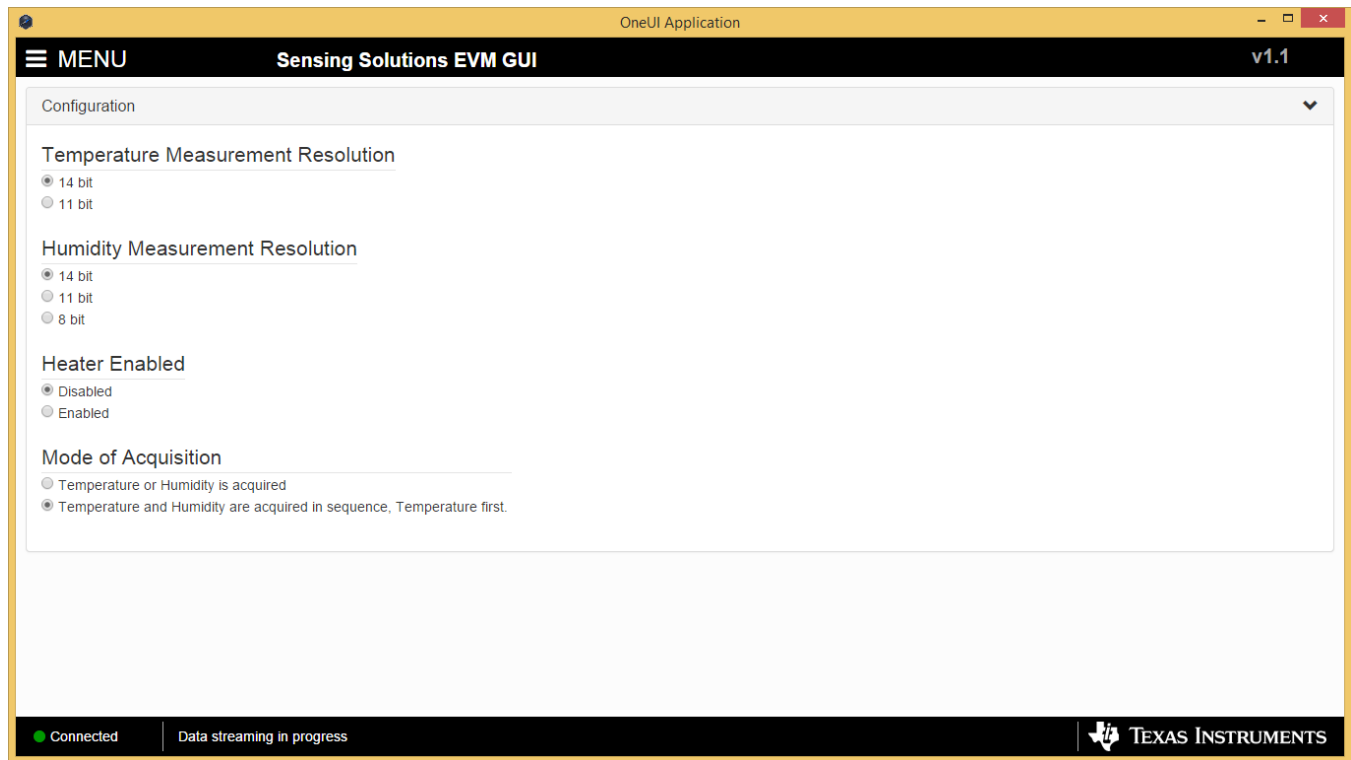

Figure 34. HDC1010 GUI Configuration Page

3.6 Streaming Measurement Data

The Sensing Solutions GUI and EVM provide a tool to capture measurement data at rates up to 500Hz. The section describes how to use the data measurement tools from the "Data Streaming" page accessible from the GUI menu.

3.6.1 Choosing Graph Units and Visible Channels

Select the drop down menu on top of the y-axis to choose the units of the graph. Available options include: Temperature and Humidity, and Raw Code.

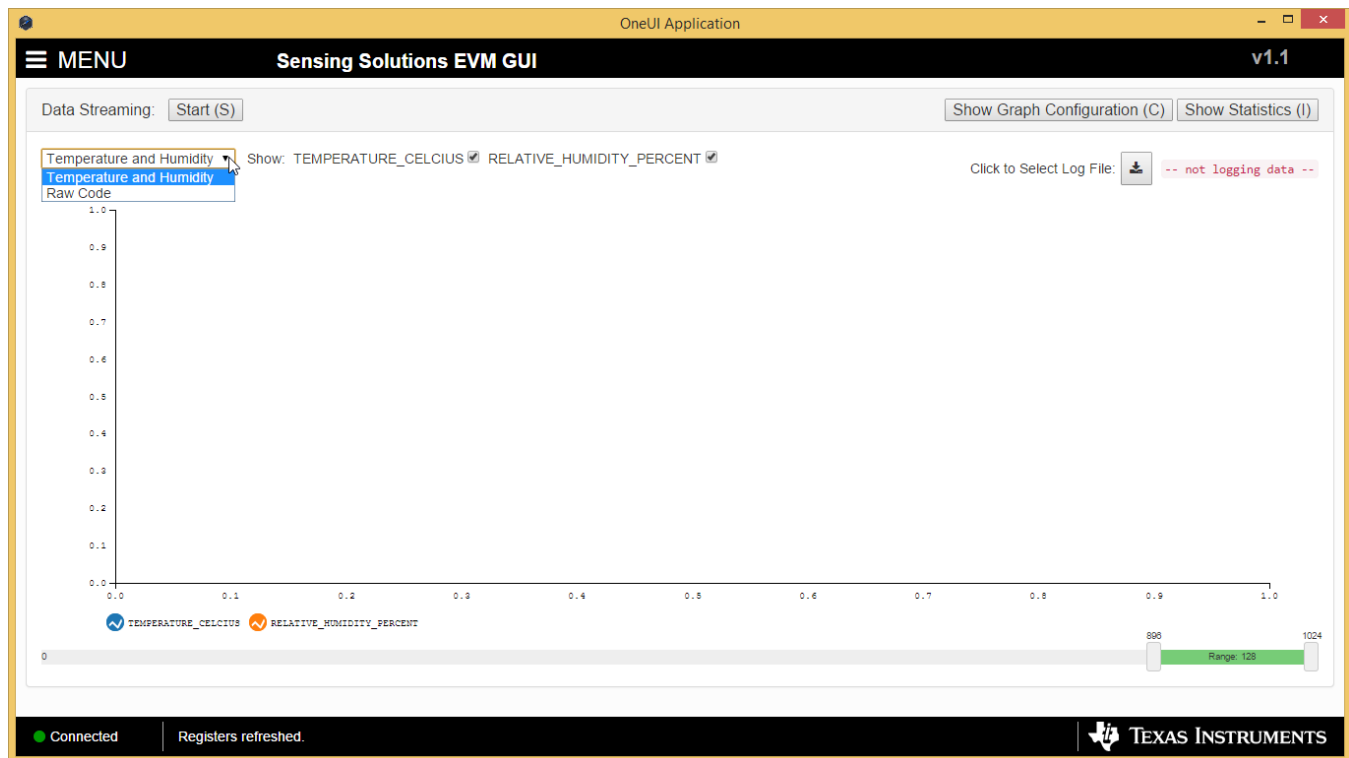

Figure 35. Selecting the Measurement Units for the Data Streaming Graph

To select which measurements are displayed in the graph, check or uncheck the temperature and relative humidity boxes shown next to the graph units. Selecting or not selecting the data types only affects the graph and not the data logged to a file. If a data type is not enabled in the Configuration page it will not appear on the Data Streaming page.

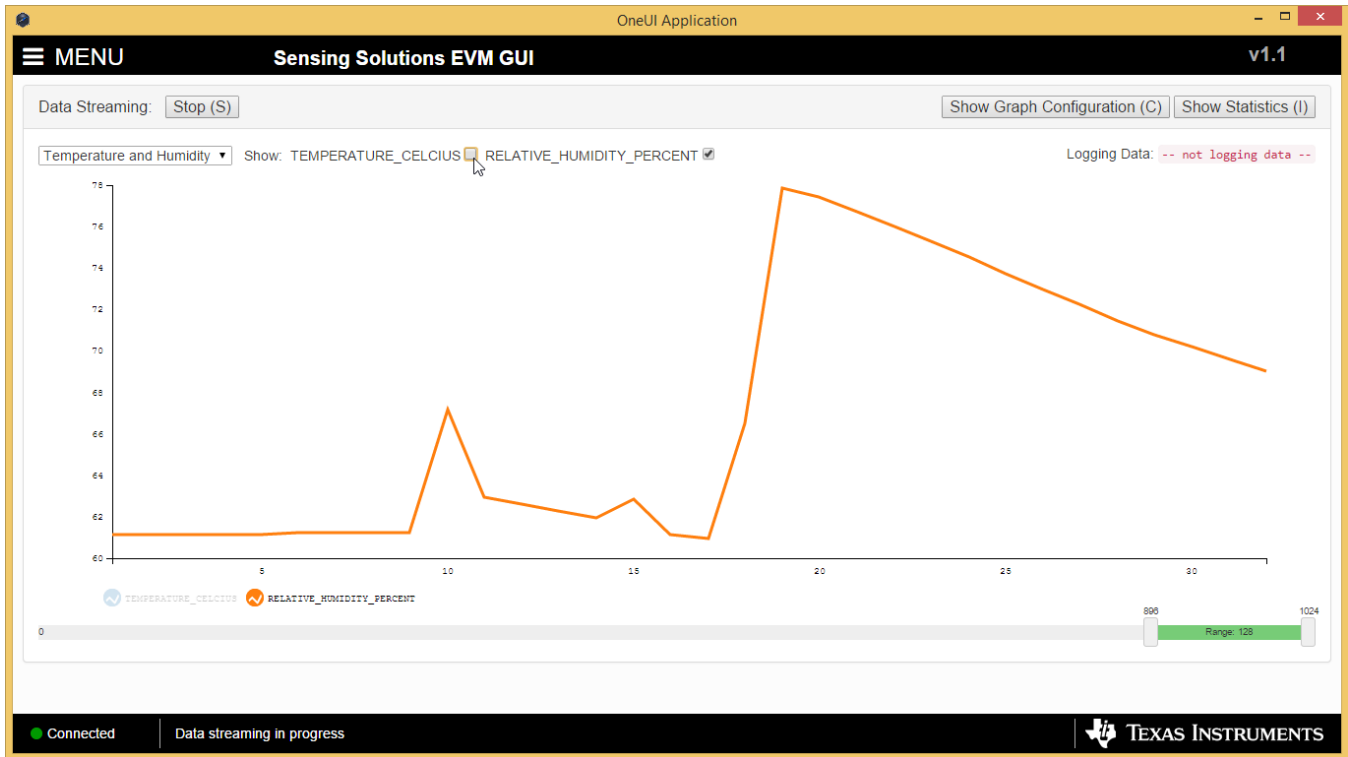

Figure 36. Data Streaming Graph Showing Only Relative Humidity Percent

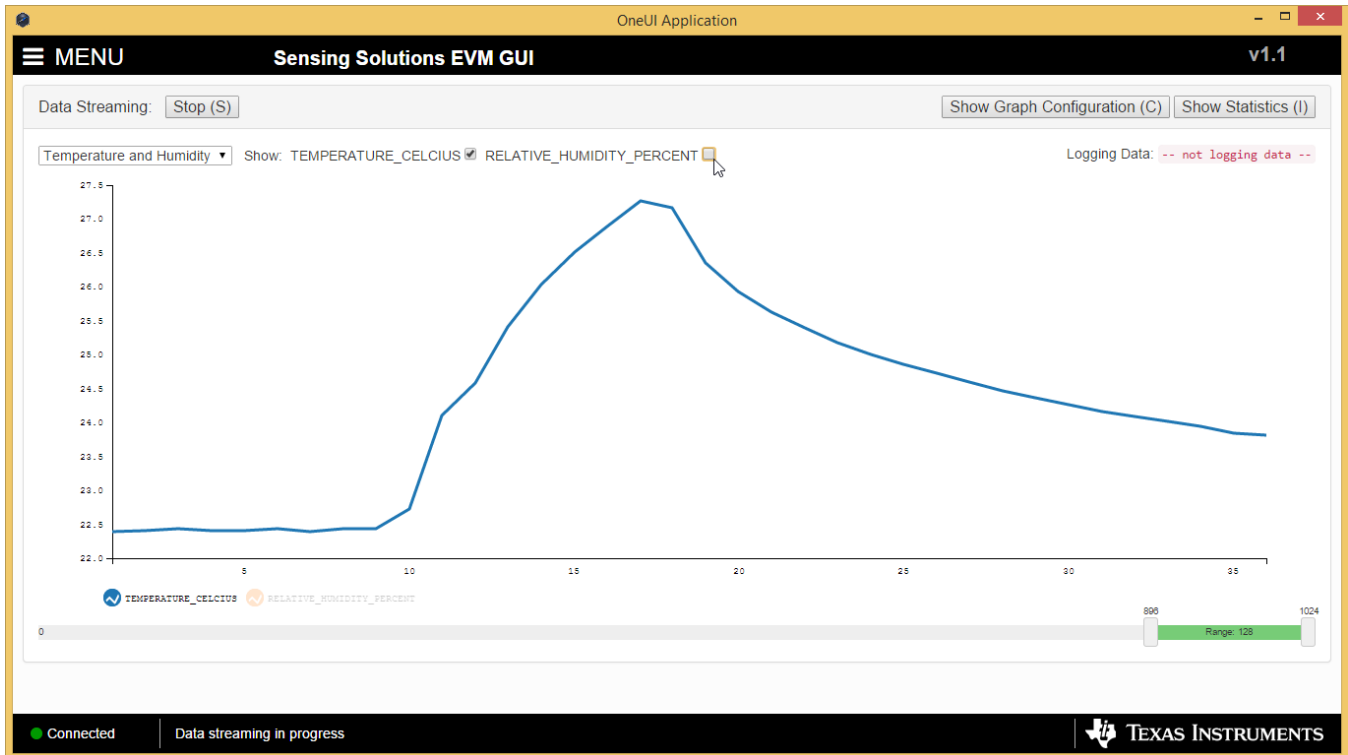

Figure 37. Data Streaming Graph Showing Only Temperature

3.6.2 Logging data to a file

Follow these steps to log measurement data to a file.

1. Click the button in the upper right under next to "Click to Select Log File"

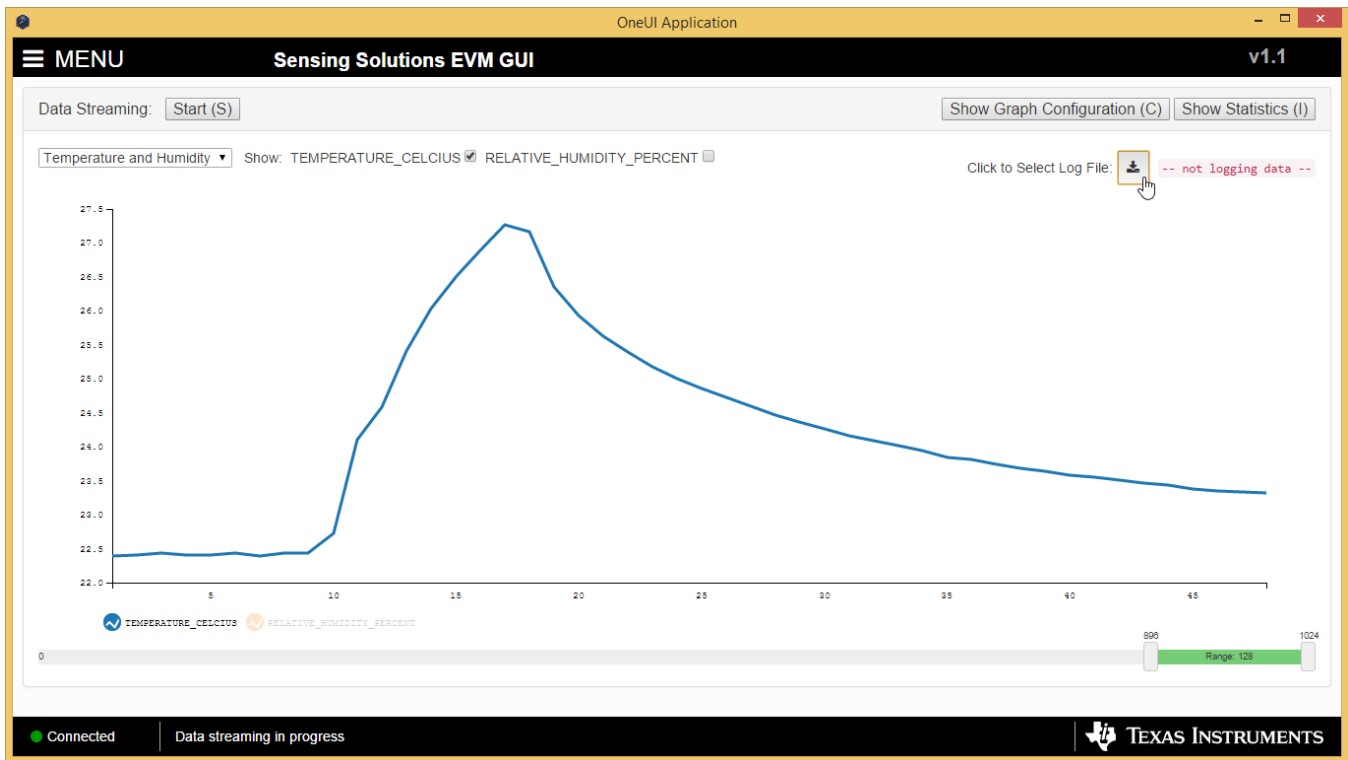

Figure 38. Select Log File Button on Data Streaming Page

2. Select a file name and directory to save the data to and then click the “Save” button

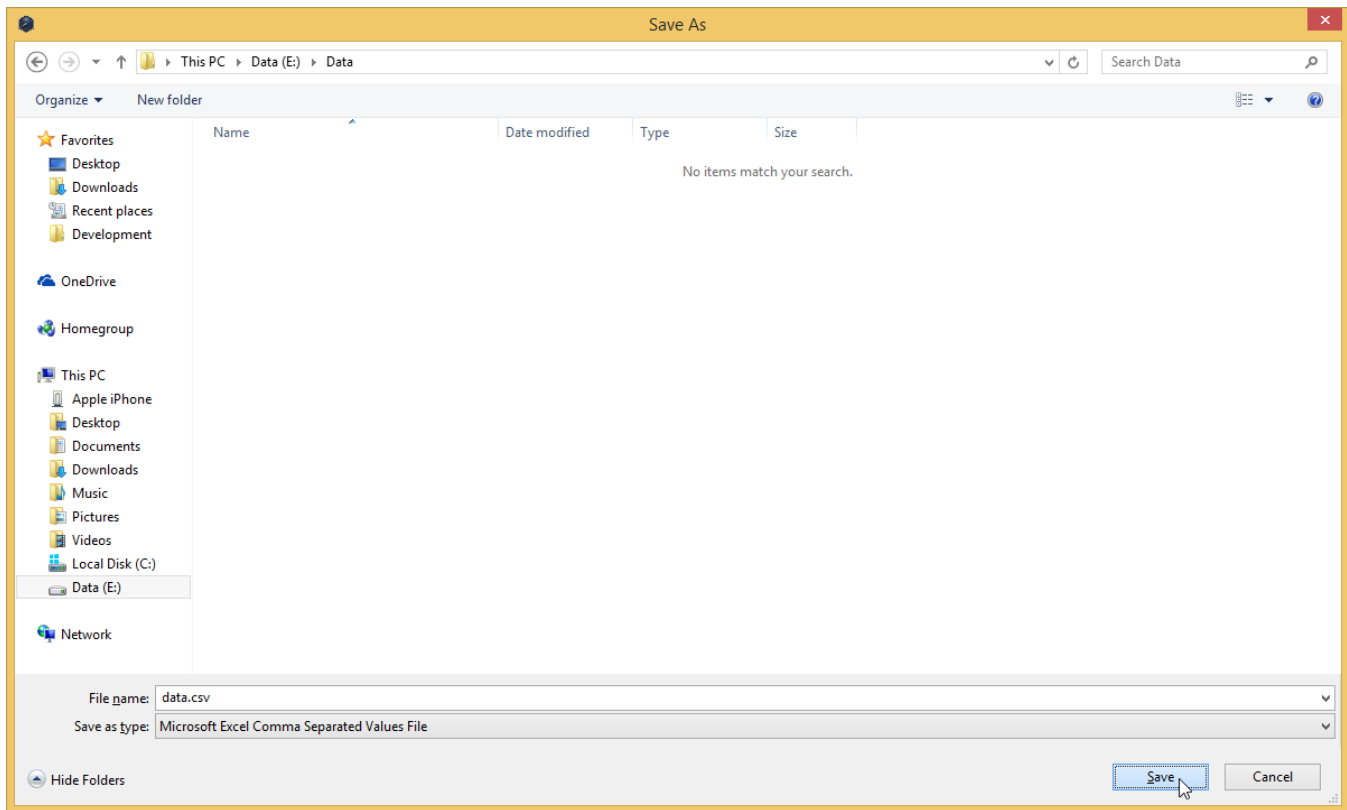

Figure 39. Selecting the Log File for Data Streaming

3.6.3 Setting the vertical axis scale and sampling rate

To set the vertical axis scale or change the sampling rate follow these steps.

1. Click the “Show Graph Configuration” button

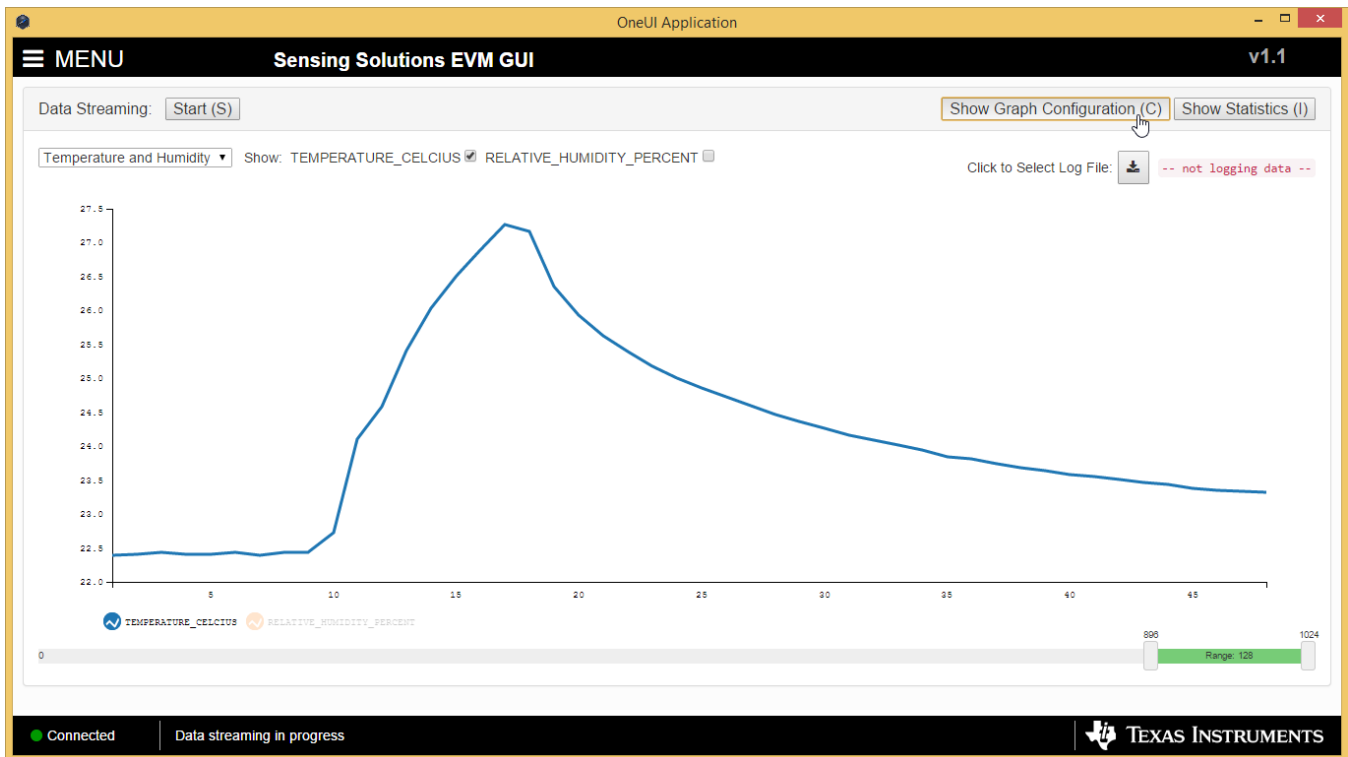

Figure 40. Show Graph Configuration Button on Data Streaming Page

2. The sampling rate can be adjusted in the "Sampling Rate" table.
 - Note that the GUI sampling rate affects only the graph and logging rate but not the actual device sampling rate

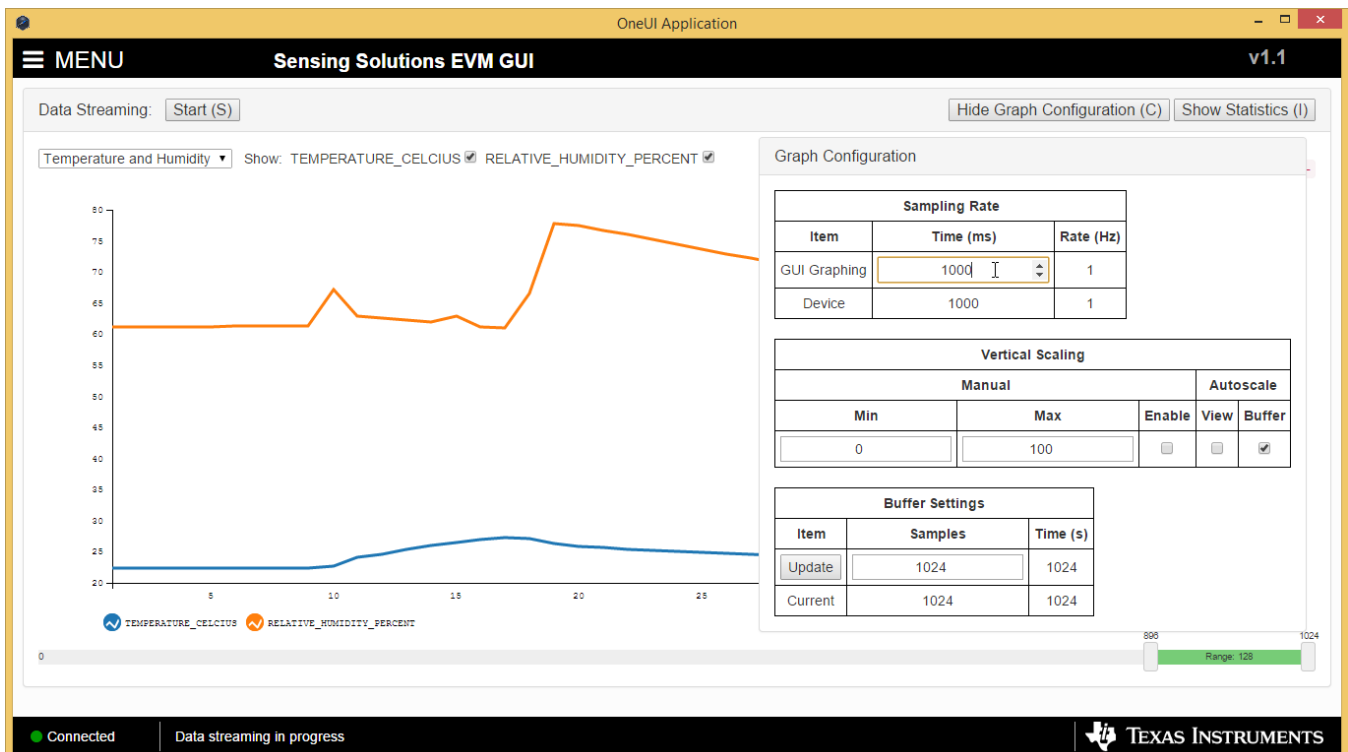

Figure 41. Setting the Data Streaming Sample Rate to 1 Second

- The vertical scaling can be automatically updated or manually controlled by selecting either checkboxes in the “Vertical Scaling” table

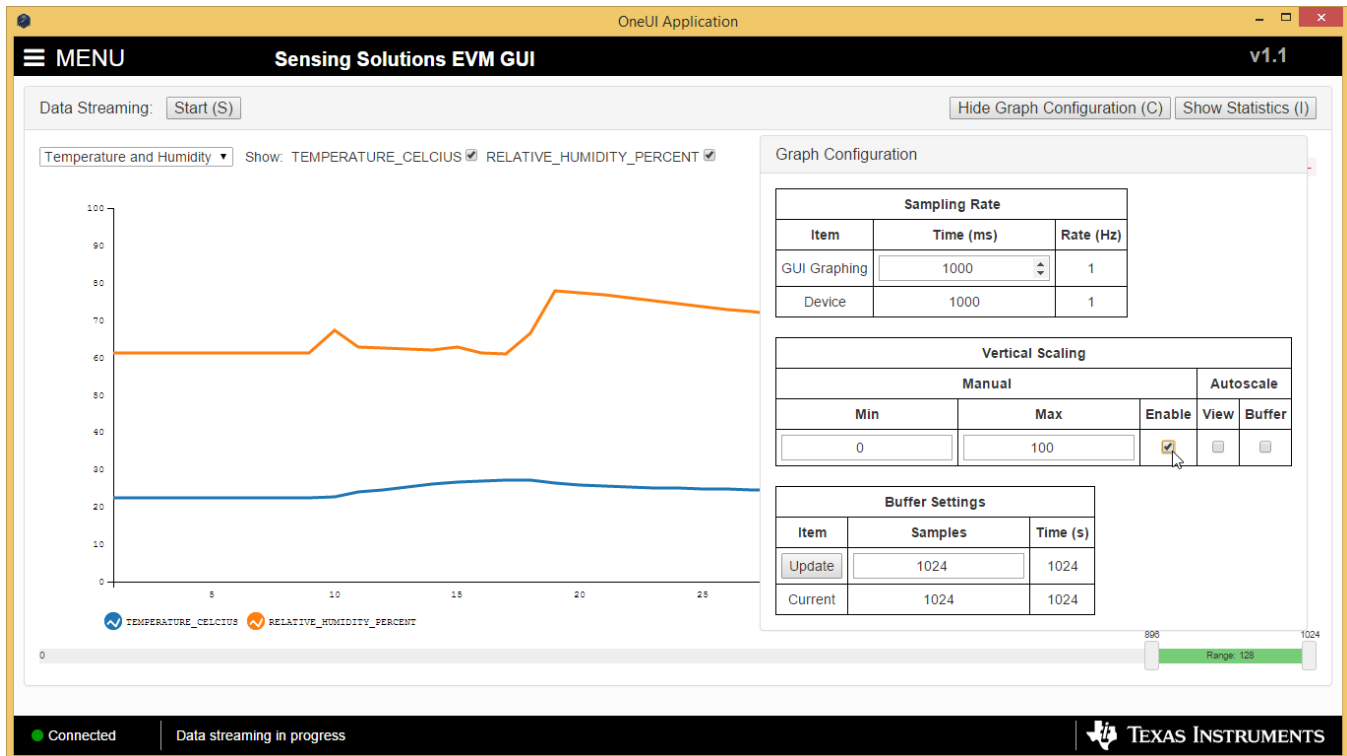

Figure 42. Manually Setting the Vertical Scale on Data Streaming Graph

3.6.4 Starting and Stopping Measurement Data Acquisition

To start data streaming click the “Start” button.

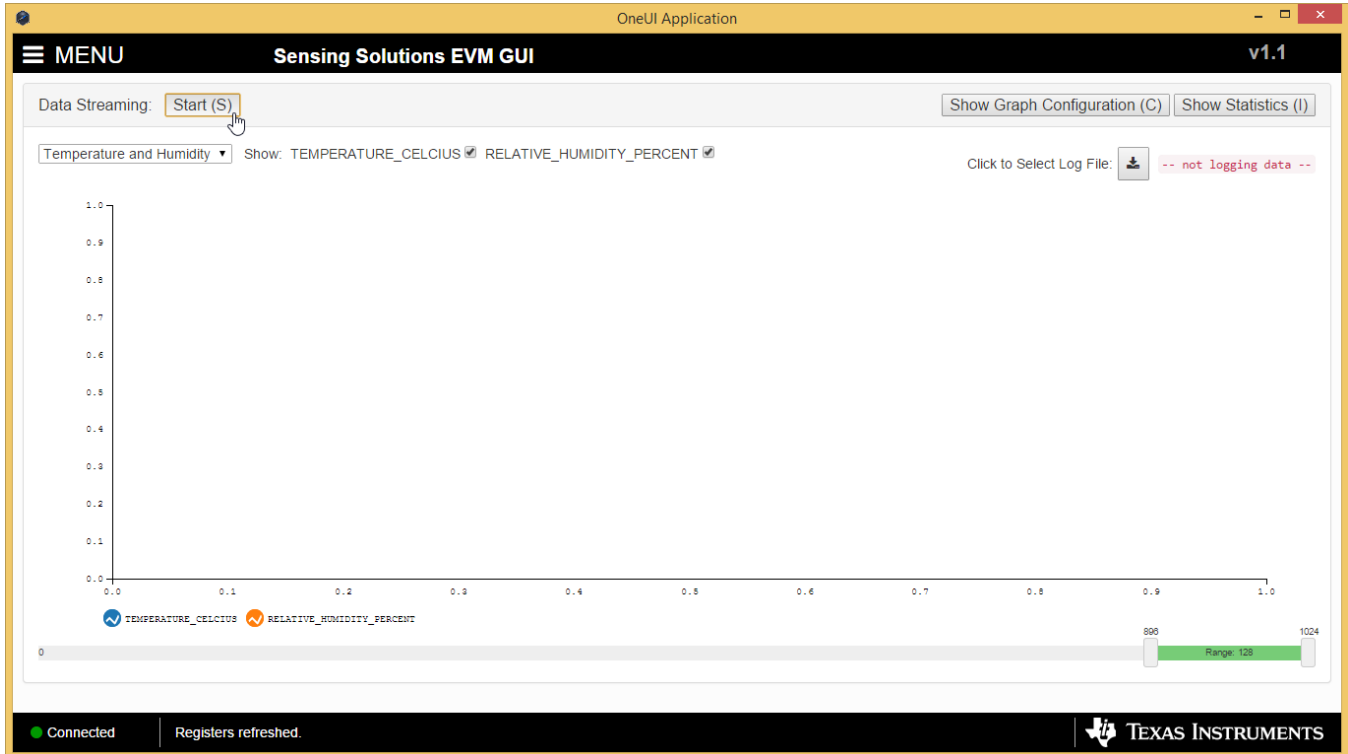

Figure 43. Starting Data Acquisition on Data Streaming Graph

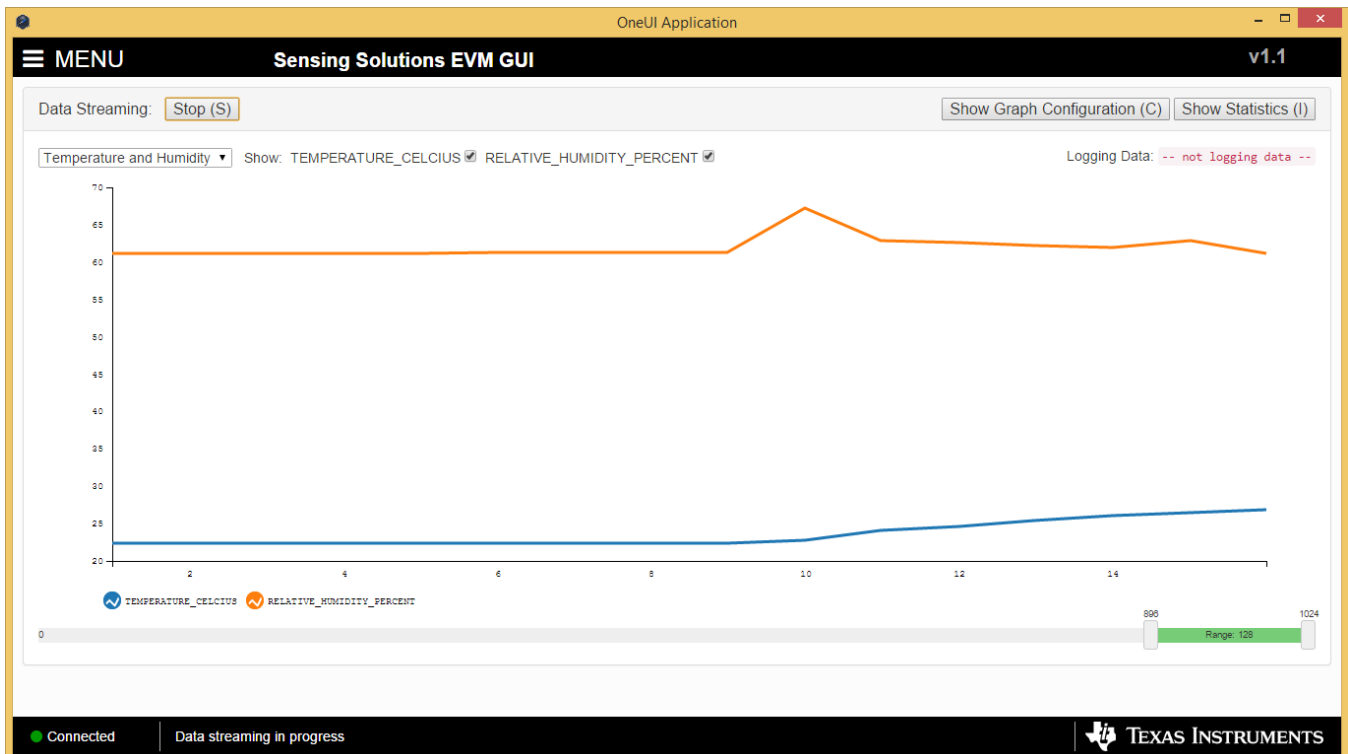

Figure 44. Data Acquisition In Progress on Data Streaming Page

To stop data streaming click the “Stop” button.

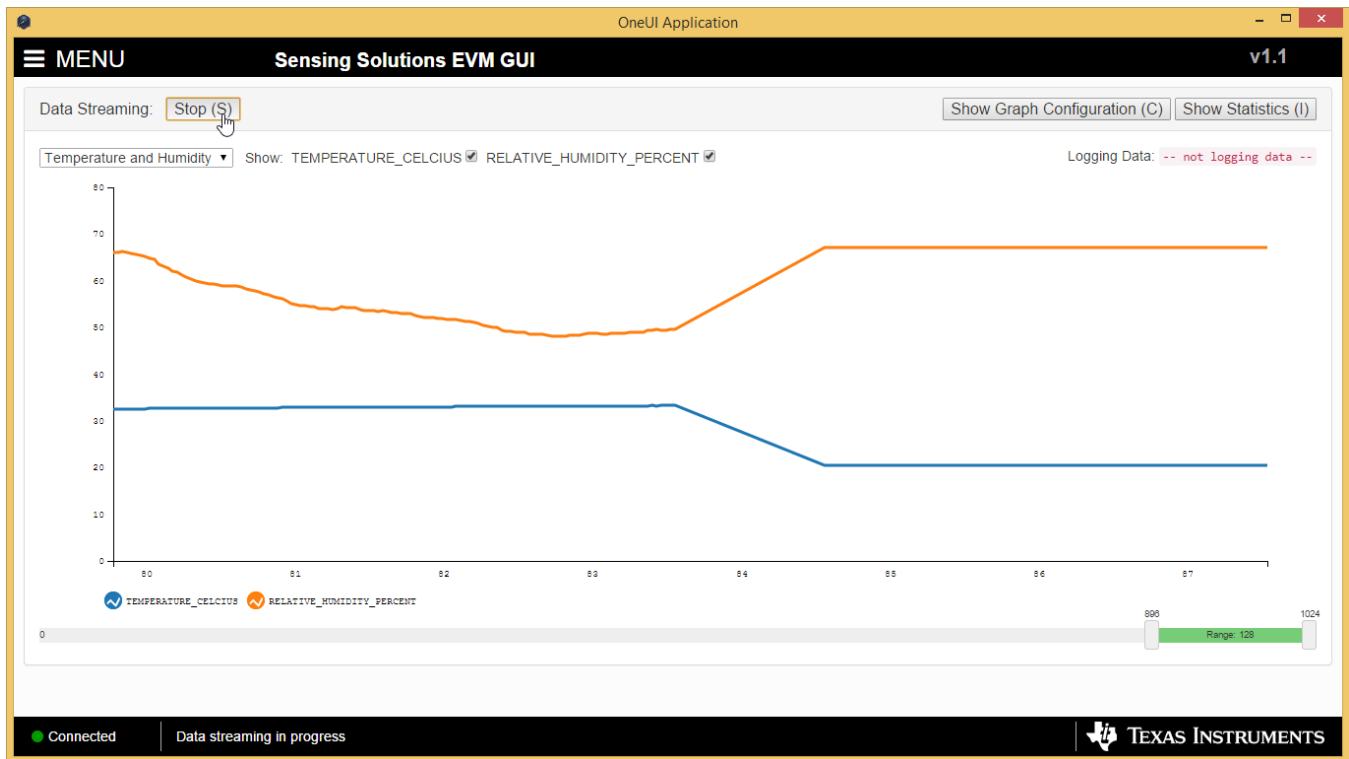

Figure 45. Stopping Data Acquisition on Data Streaming Graph

3.6.5 Displaying Measurement Data Statistics

Click the “Show Statistics” button to view the measurement statistics.

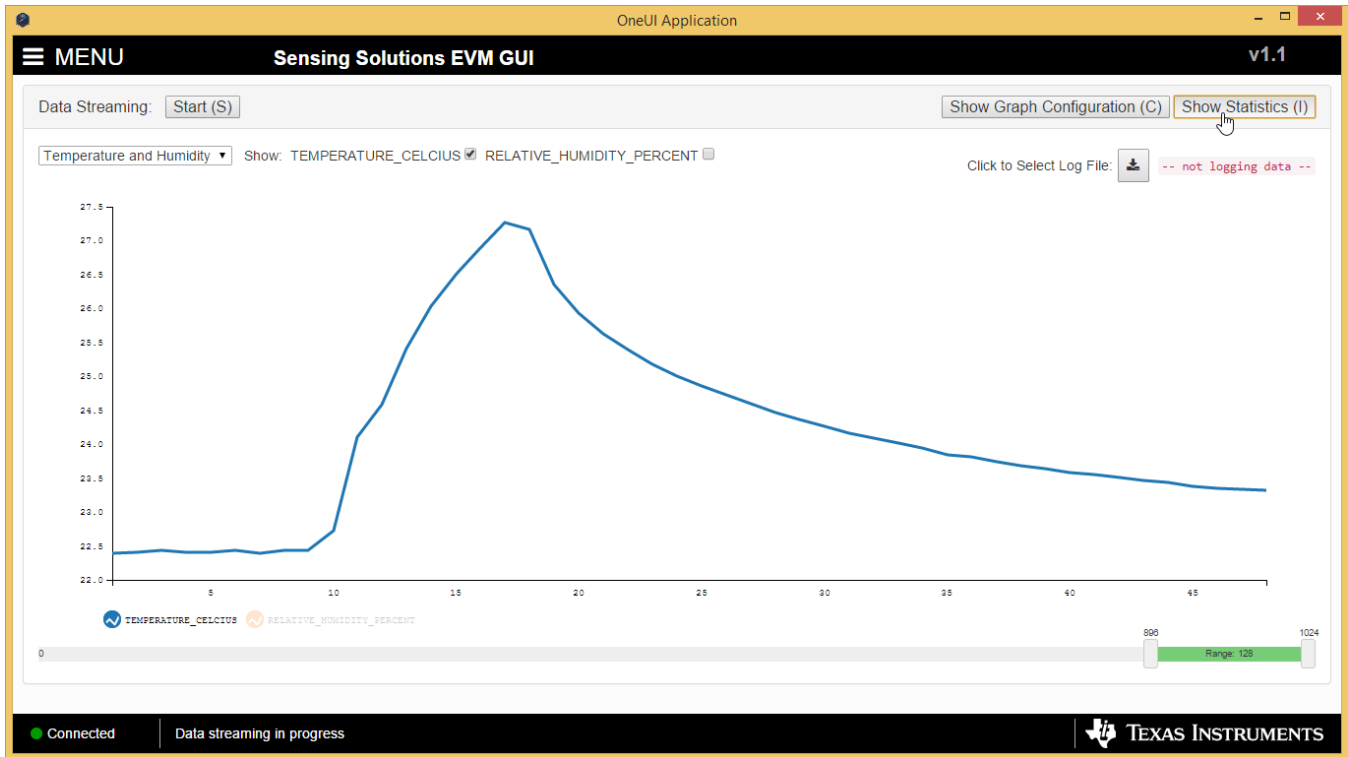

Figure 46. Show Statistics Button on Data Streaming Graph

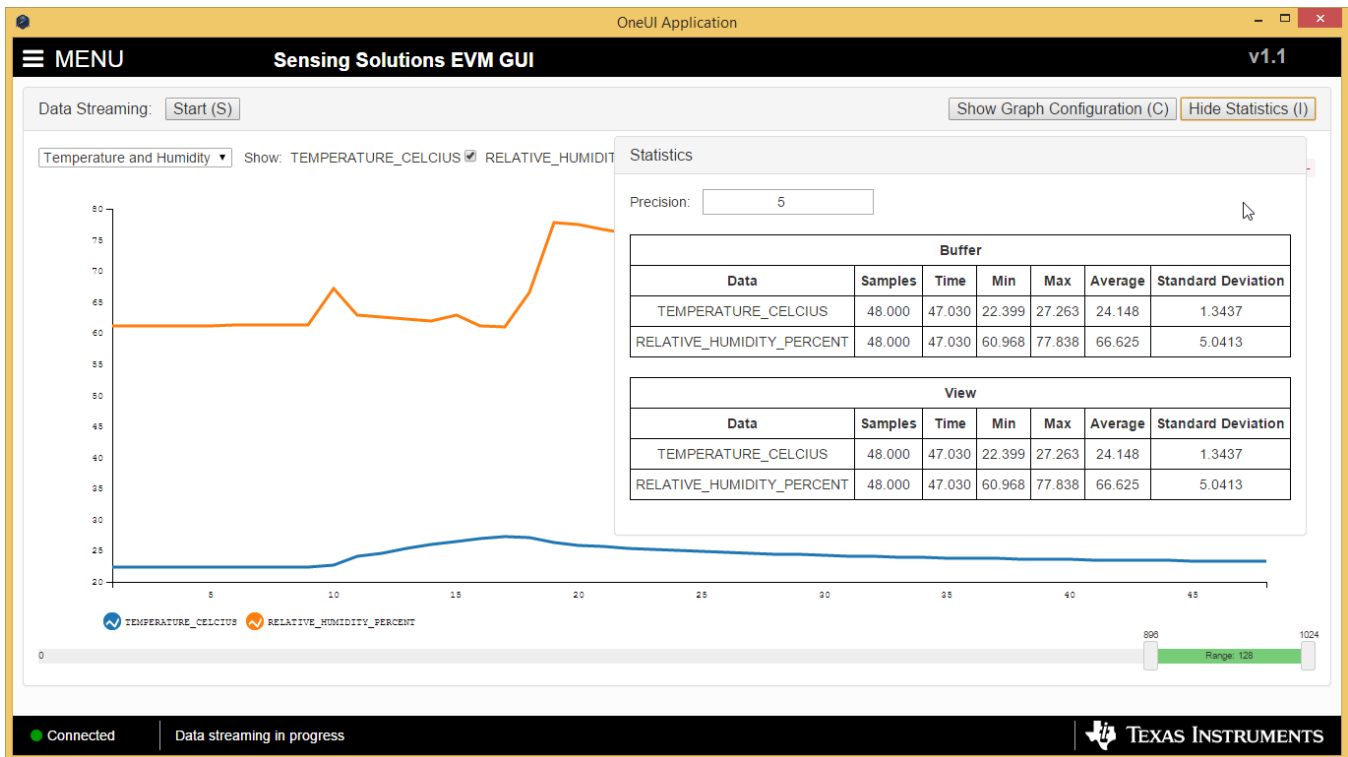

Figure 47. Data Statistics on Data Streaming Graph

3.6.6 Navigating the GUI's Data Buffer

After stopping the data stream, the number of data samples displayed can be selected by moving the dual slider under the graph.

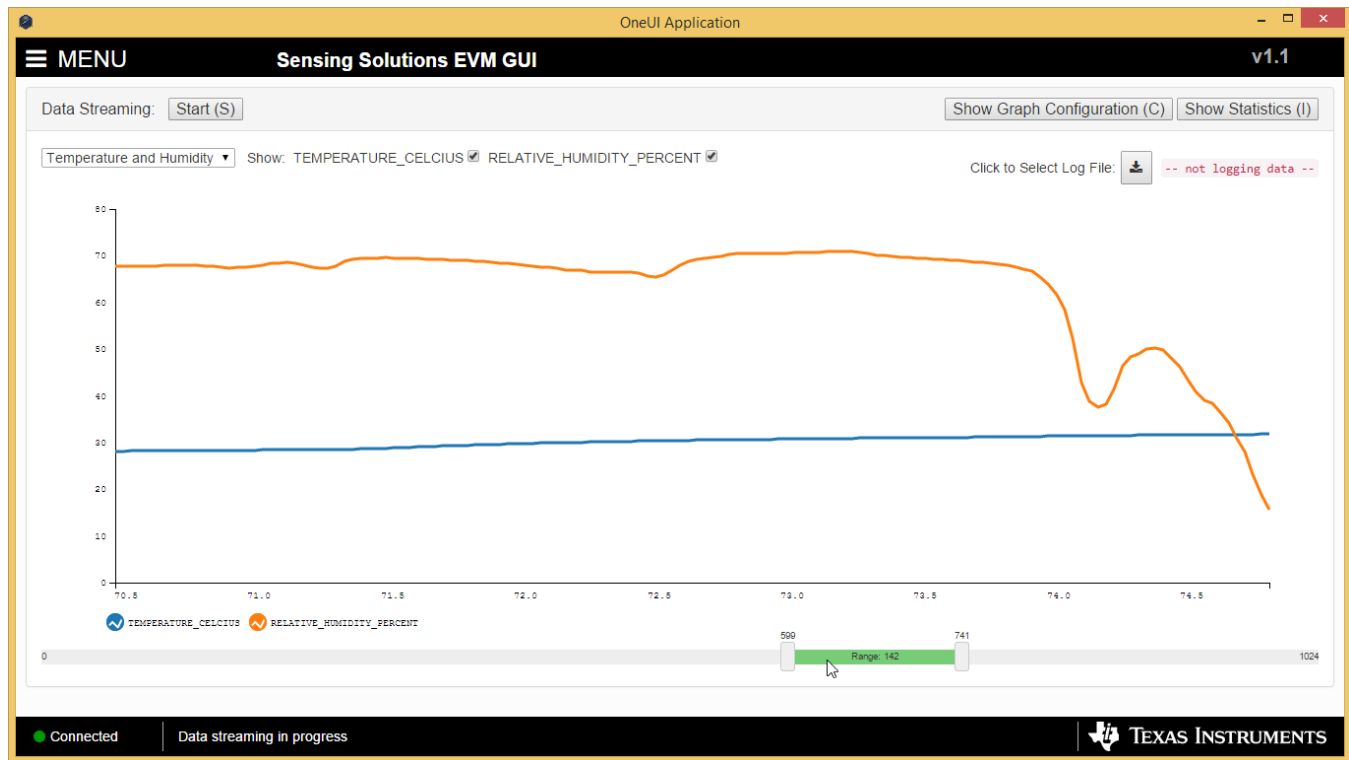

Figure 48. Moving the Data Graph Sample View



Figure 49. Viewing the Entire Buffer on Data Graph

3.7 Updating the EVM Firmware

To upload new firmware to the EVM, navigate to the "Firmware" page from the GUI menu and follow these steps.

1. Click the button to select a TI-TXT firmware file

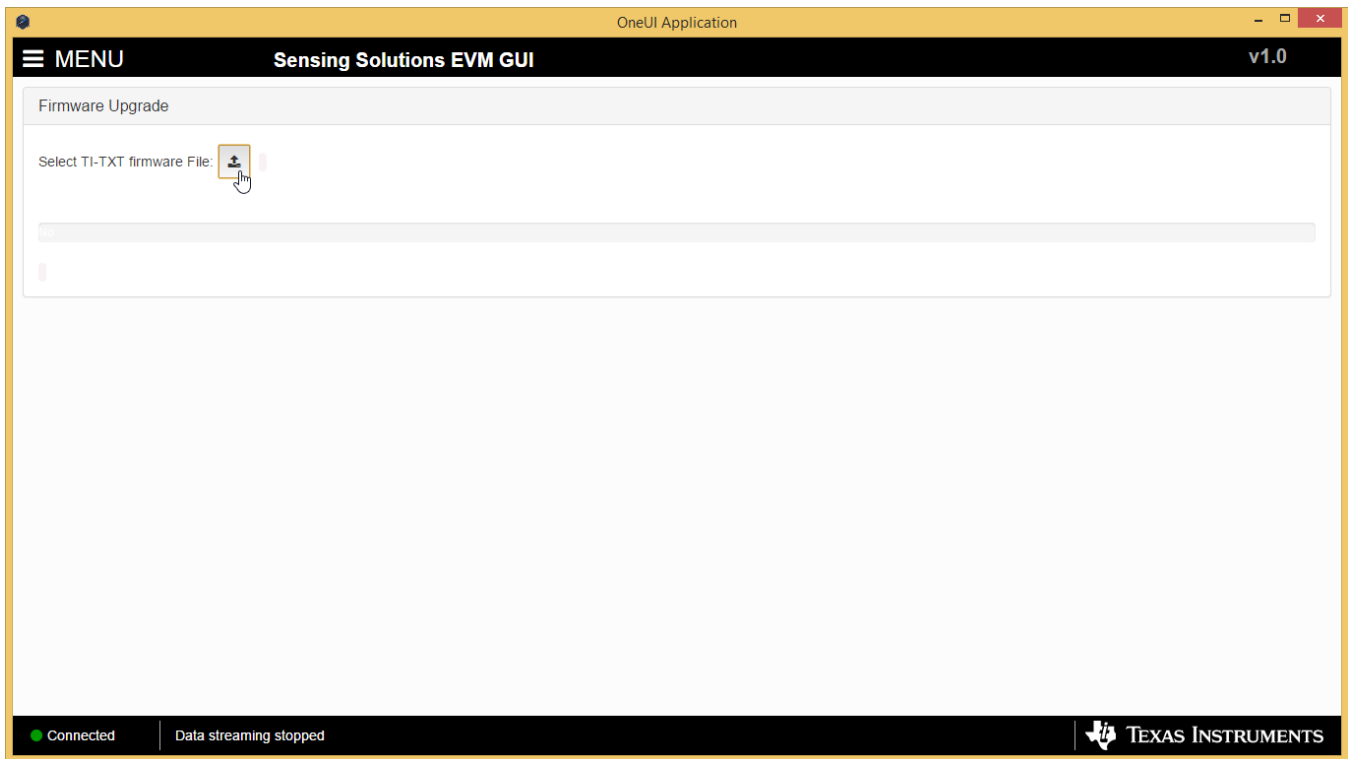

Figure 50. Select TI-TXT File Button on Firmware Upload Page

2. Select the firmware file and click “Open”

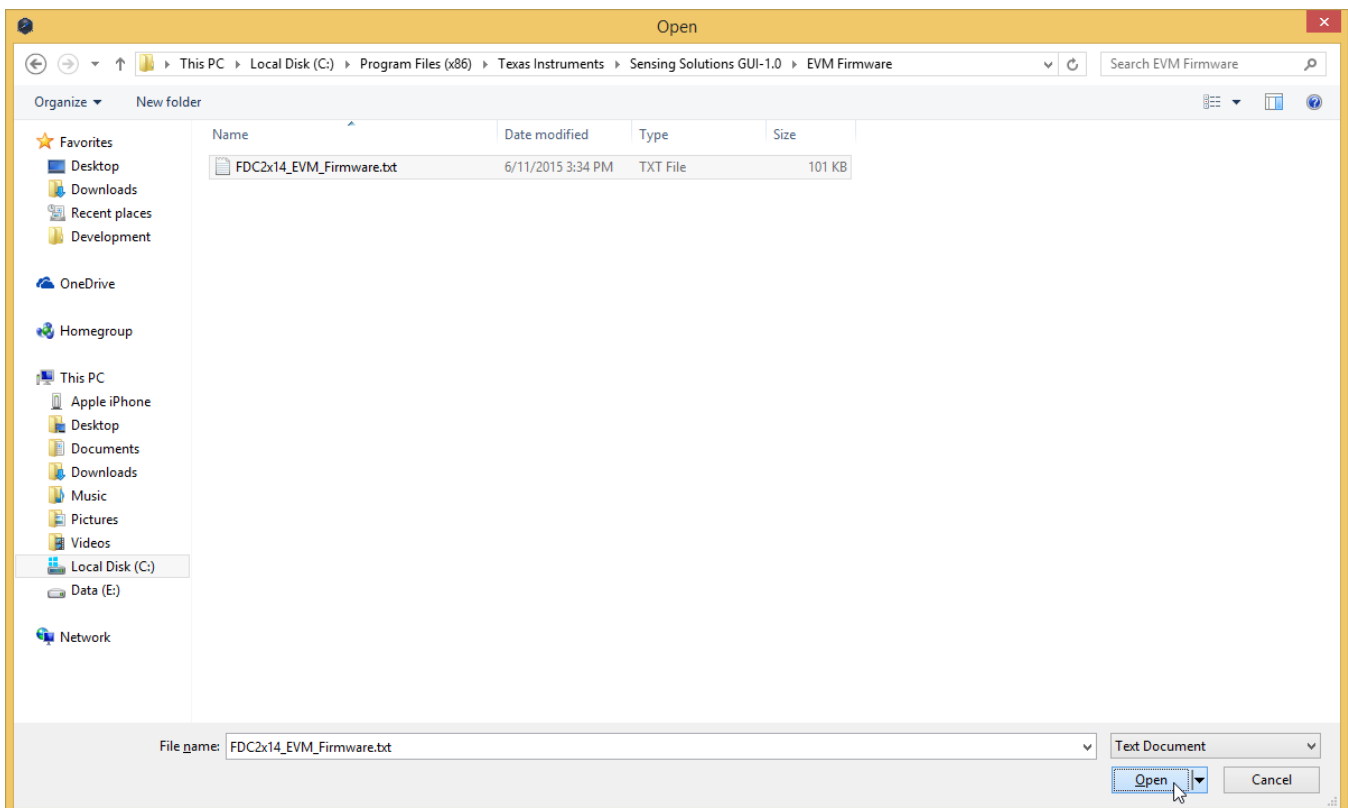

Figure 51. Selecting TI-TXT Firmware File for Upload to EVM

3. Click the “Upload Firmware” button

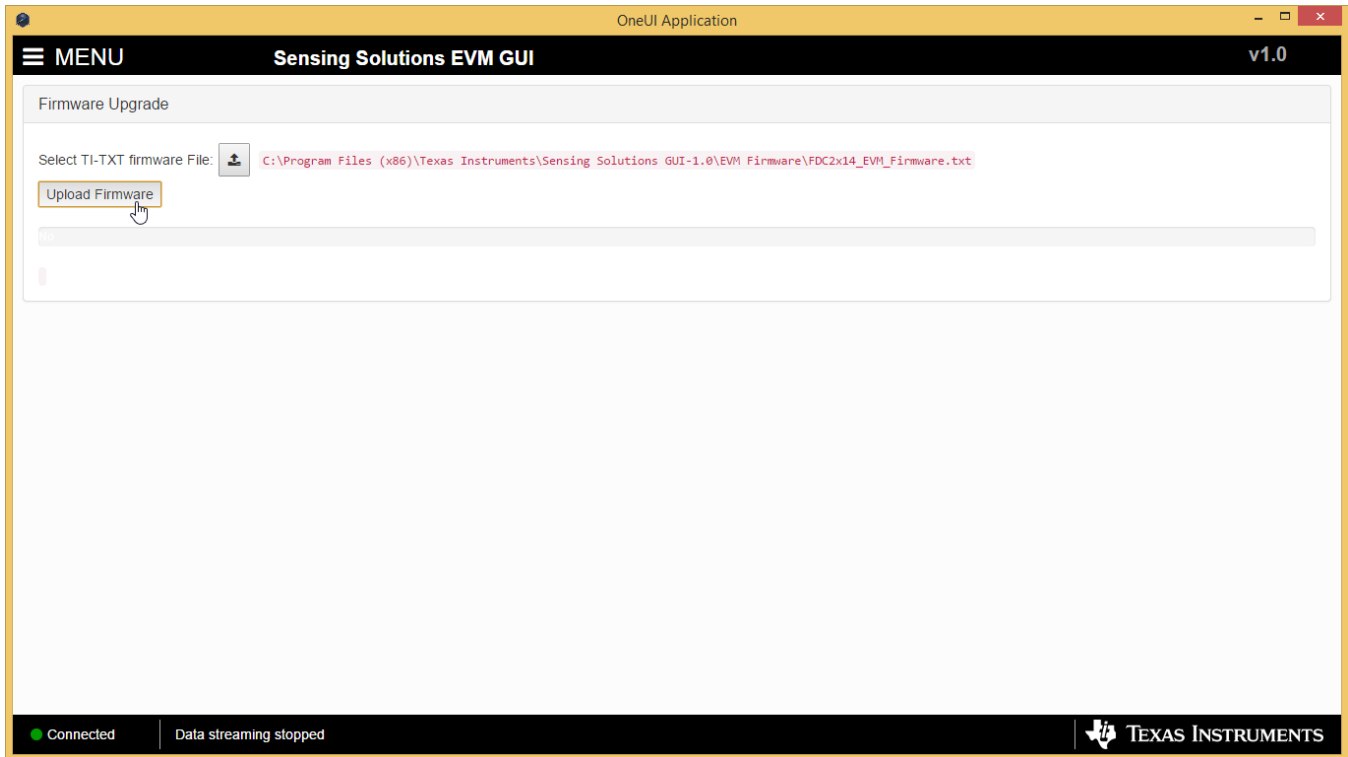

Figure 52. Upload Firmware Button on Firmware Upload Page

4. Wait for the firmware to upload. Do NOT disconnect the EVM from the PC at this time! Also note that the GUI will disconnect from the EVM. The upload process should not take more than one minute.

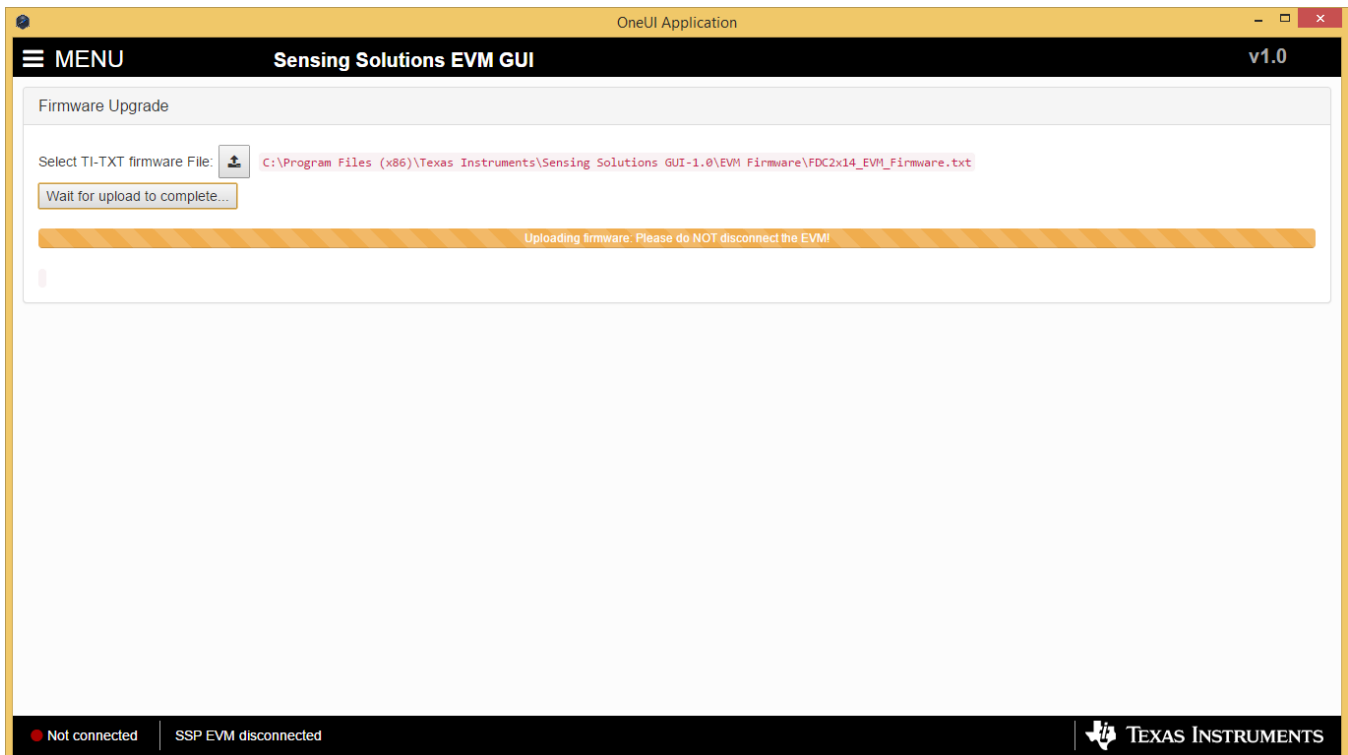

Figure 53. Firmware Upload in Progress

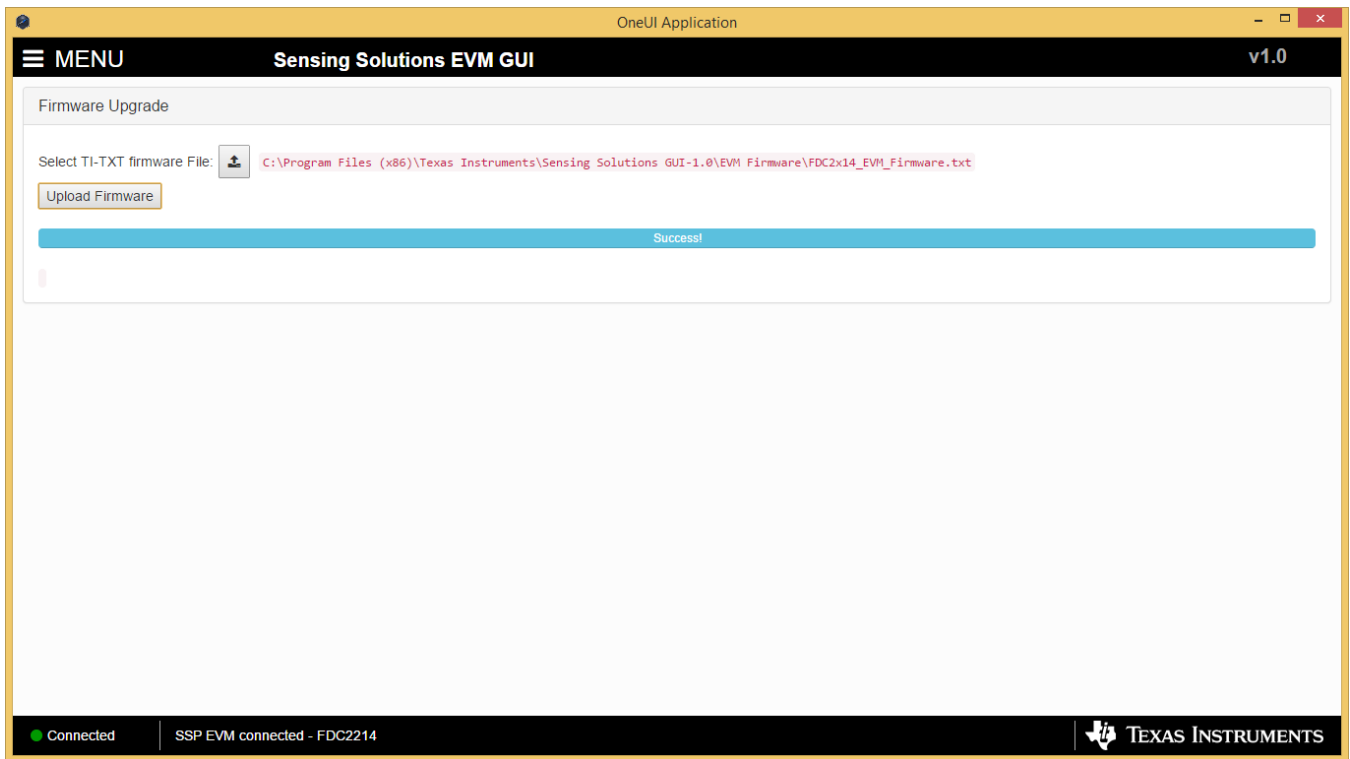
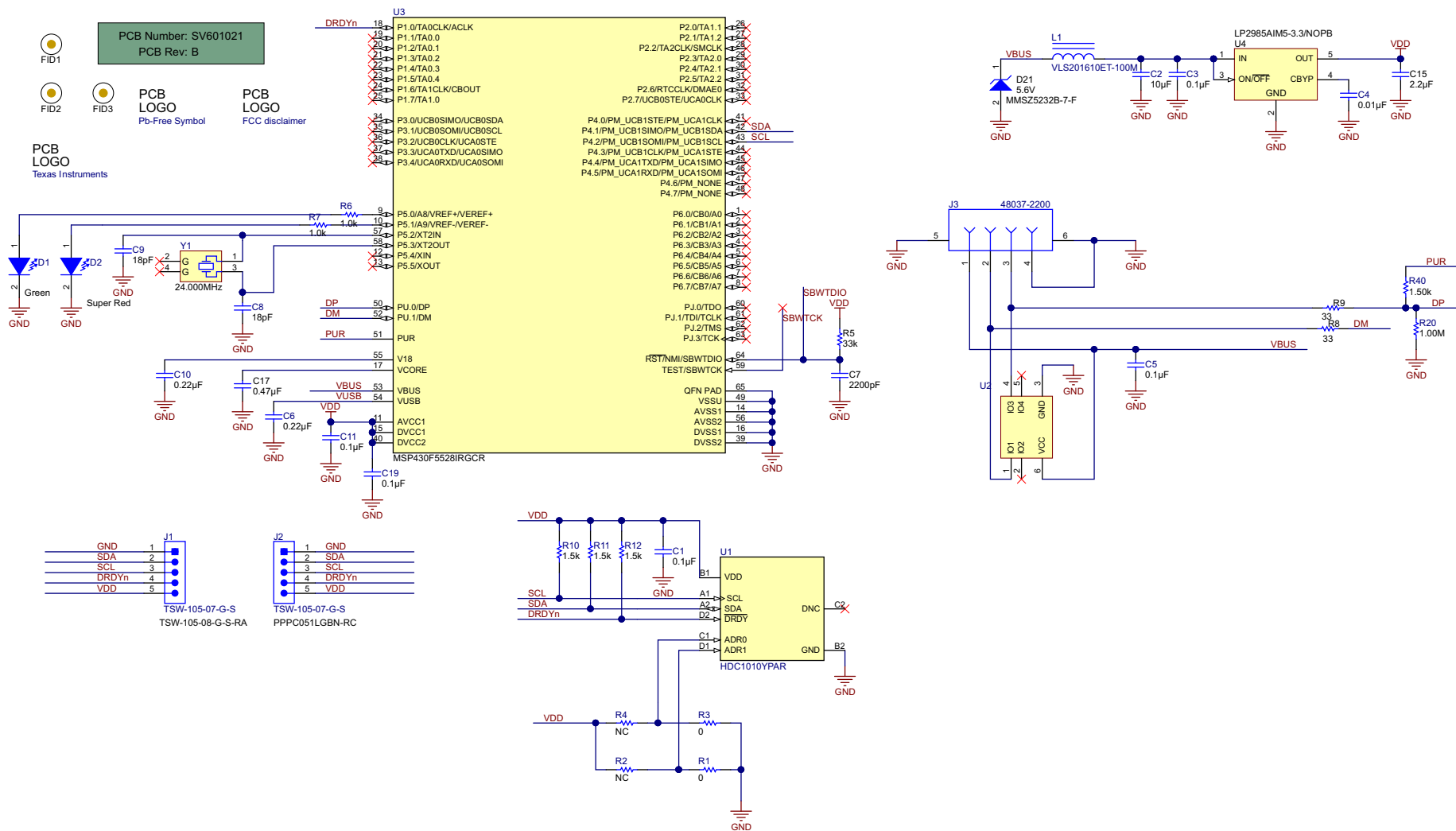

Figure 54. Firmware Upload Success

5 Schematic



Copyright © 2016, Texas Instruments Incorporated

Figure 57. HDC1010EVM Schematic

6 HDC1010EVM Bill of Materials

COUNT	REF DES	DESCRIPTION	FOOTPRINT	PART NUMBER
1	C1	CAP, CERM, 0.1µF, 10V, ±10%, X5R, 0201	0201	CL03A104KP3NNNC
1	C2	CAP, CERM, 10µF, 10V, ±20%, X5R, 0603	0603	C1608X5R1A106M080A C
4	C3, C5, C11, C19	CAP, CERM, 0.1µF, 16V, ±5%, X7R, 0402	0402	GRM155R71C104JA88D
1	C4	CAP, CERM, 0.01µF, 50V, ±5%, C0G/NP0, 0603	0603	CGA3E2C0G1H103J080 AA
1	C6	CAP, CERM, 0.22µF, 16V, ±10%, X7R, 0402	0402	GRM155R71C224KA12D
1	C7	CAP, CERM, 2200pF, 50V, ±10%, X7R, 0603	0603	C0603X222K5RACTU
2	C8, C9	CAP, CERM, 18pF, 100V, ±5%, C0G/NP0, 0603	0603	GRM1885C2A180JA01D
1	C10	CAP, CERM, 0.22µF, 25V, ±10%, X5R, 0603	0603	06033D224KAT2A
1	C15	CAP, CERM, 2.2µF, 10V, ±10%, X5R, 0603	0603	C0603C225K8PACTU
1	C17	CAP, CERM, 0.47µF, 10V, ±10%, X7R, 0603	0603	C0603C474K8RACTU
1	D1	GREEN LED, 1.7x0.65x0.8mm	0603	LG L29K-G2J1-24-Z
1	D2	SUPER RED LED, 1.6x0.60x0.8mm	0603	SML-LX0603SRW-TR
1	D21	Diode, Zener, 5.6V, 500mW, SOD-123	SOD-123	MMSZ5232B-7-F
2	J1, J2	Header, TH, 100mil, 5x1, Gold plated, 230 mil above insulator	-	TSW-105-07-G-S
1	J3	Connector, USB Type A, 4POS R/A, SMD	-	48037-2200
1	L1	INDUCTOR POWER 10µH .45A SMD	VLS201610	VLS201610ET-100M
2	R1, R3	RES, 0Ω, 5%, 0.05W, 0201	0201M	ERJ-1GE0R00C
2	R2, R4	RES, 0Ω, 5%, 0.05W, 0201	0201M	ERJ-1GE0R00C
1	R5	RES, 33kΩ, 5%, 0.063W, 0402	0402	CRCW040233K0JNED
2	R6, R7	RES, 1kΩ, 5%, 0.063W, 0402	0402	CRCW04021K00JNED
2	R8, R9	RES, 33Ω, 5%, 0.063W, 0402	0402	CRCW040233R0JNED
3	R10, R11, R12	RES, 1.5kΩ, 5%, 0.063W, 0402	0402	CRCW04021K50JNED
1	R20	RES, 1MΩ 5%, 0.063W, 0402	0402	RC0402FR-071ML
1	R40	RES, 1.50kΩ, 1%, 0.063W, 0402	0402	CRCW04021K50FKED
1	U1	HDC1010 – Low Power, High Accuracy Digital Humidity Sensor with Temperature Sensor	YPA0008	HDC1010
1	U2	4-Channels ESD-Protection Array for High-Speed Data Interfaces	DRY0006A	TPD4E004DRY
1	U3	MSP430F5528 Mixed Signal micro-controller	RGC0064B	MSP430F5528IRGC
1	U4	Micropower 150 mA Low-Noise Ultra Low-Dropout Regulator, 5-pin SOT-23, Pb-Free	MF05A	LP2985AIM5-3.3/NOPB
1	Y1	CRYSTAL 24.000MHZ, 18pF, SMD	ABMM	ABMM-24.000MHZ-B2-T

IMPORTANT NOTICE

Texas Instruments Incorporated and its subsidiaries (TI) reserve the right to make corrections, enhancements, improvements and other changes to its semiconductor products and services per JESD46, latest issue, and to discontinue any product or service per JESD48, latest issue. Buyers should obtain the latest relevant information before placing orders and should verify that such information is current and complete. All semiconductor products (also referred to herein as "components") are sold subject to TI's terms and conditions of sale supplied at the time of order acknowledgment.

TI warrants performance of its components to the specifications applicable at the time of sale, in accordance with the warranty in TI's terms and conditions of sale of semiconductor products. Testing and other quality control techniques are used to the extent TI deems necessary to support this warranty. Except where mandated by applicable law, testing of all parameters of each component is not necessarily performed.

TI assumes no liability for applications assistance or the design of Buyers' products. Buyers are responsible for their products and applications using TI components. To minimize the risks associated with Buyers' products and applications, Buyers should provide adequate design and operating safeguards.

TI does not warrant or represent that any license, either express or implied, is granted under any patent right, copyright, mask work right, or other intellectual property right relating to any combination, machine, or process in which TI components or services are used. Information published by TI regarding third-party products or services does not constitute a license to use such products or services or a warranty or endorsement thereof. Use of such information may require a license from a third party under the patents or other intellectual property of the third party, or a license from TI under the patents or other intellectual property of TI.

Reproduction of significant portions of TI information in TI data books or data sheets is permissible only if reproduction is without alteration and is accompanied by all associated warranties, conditions, limitations, and notices. TI is not responsible or liable for such altered documentation. Information of third parties may be subject to additional restrictions.

Resale of TI components or services with statements different from or beyond the parameters stated by TI for that component or service voids all express and any implied warranties for the associated TI component or service and is an unfair and deceptive business practice. TI is not responsible or liable for any such statements.

Buyer acknowledges and agrees that it is solely responsible for compliance with all legal, regulatory and safety-related requirements concerning its products, and any use of TI components in its applications, notwithstanding any applications-related information or support that may be provided by TI. Buyer represents and agrees that it has all the necessary expertise to create and implement safeguards which anticipate dangerous consequences of failures, monitor failures and their consequences, lessen the likelihood of failures that might cause harm and take appropriate remedial actions. Buyer will fully indemnify TI and its representatives against any damages arising out of the use of any TI components in safety-critical applications.

In some cases, TI components may be promoted specifically to facilitate safety-related applications. With such components, TI's goal is to help enable customers to design and create their own end-product solutions that meet applicable functional safety standards and requirements. Nonetheless, such components are subject to these terms.

No TI components are authorized for use in FDA Class III (or similar life-critical medical equipment) unless authorized officers of the parties have executed a special agreement specifically governing such use.

Only those TI components which TI has specifically designated as military grade or "enhanced plastic" are designed and intended for use in military/aerospace applications or environments. Buyer acknowledges and agrees that any military or aerospace use of TI components which have **not** been so designated is solely at the Buyer's risk, and that Buyer is solely responsible for compliance with all legal and regulatory requirements in connection with such use.

TI has specifically designated certain components as meeting ISO/TS16949 requirements, mainly for automotive use. In any case of use of non-designated products, TI will not be responsible for any failure to meet ISO/TS16949.

Products

Audio	www.ti.com/audio
Amplifiers	amplifier.ti.com
Data Converters	dataconverter.ti.com
DLP® Products	www.dlp.com
DSP	dsp.ti.com
Clocks and Timers	www.ti.com/clocks
Interface	interface.ti.com
Logic	logic.ti.com
Power Mgmt	power.ti.com
Microcontrollers	microcontroller.ti.com
RFID	www.ti-rfid.com
OMAP Applications Processors	www.ti.com/omap
Wireless Connectivity	www.ti.com/wirelessconnectivity

Applications

Automotive and Transportation	www.ti.com/automotive
Communications and Telecom	www.ti.com/communications
Computers and Peripherals	www.ti.com/computers
Consumer Electronics	www.ti.com/consumer-apps
Energy and Lighting	www.ti.com/energy
Industrial	www.ti.com/industrial
Medical	www.ti.com/medical
Security	www.ti.com/security
Space, Avionics and Defense	www.ti.com/space-avionics-defense
Video and Imaging	www.ti.com/video

TI E2E Community

e2e.ti.com

Looking for pricing, stock, or lifecycle information?

Click below to explore more details on WIN SOURCE:

 [View HDC1010EVM](#) on WIN SOURCE

 [Texas Instruments](#) Information

Optimize Your Supply Chain with WIN SOURCE Solutions

-  Global Sourcing Solution
-  Obsolete Management
-  Cost Control Management
-  Shortage Management
-  Alternative Solution
-  Excess Inventory Management