



**THE DATASHEET OF
SD5410-001**



SD3410/5410

Silicon Photodarlington

FEATURES

- TO-46 metal can package
- Choice of flat window or lensed package
- 90° or 12° (nominal) acceptance angle option
- Wide operating temperature range (-55°C to +125°C)
- Wide sensitivity ranges
- Mechanically and spectrally matched to SE3450/5450, SE3455/5455 and SE3470/5470 infrared emitting diodes

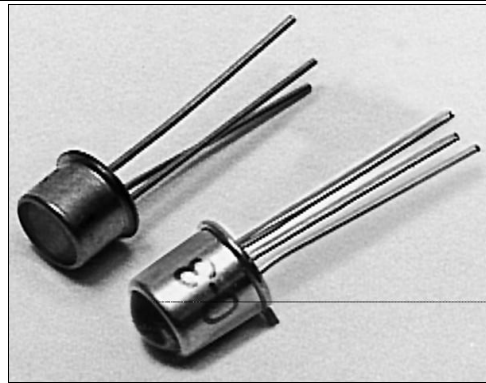

INFRA-17.TIF

DESCRIPTION

The SD3410/5410 series consists of an NPN silicon photodarlington mounted in a TO-46 metal can package. The SD3410 has flat window cans providing a wide acceptance angle, while the SD5410 has glass lensed cans providing a narrow acceptance angle. The TO-46 packages are ideally suited for operation in hostile environments.

OUTLINE DIMENSIONS in inches (mm)

Tolerance	3 plc decimals	±0.005(0.12)
	2 plc decimals	±0.020(0.51)

SD3410

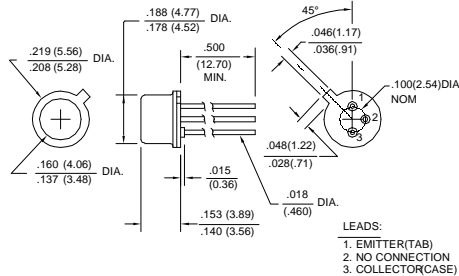

DIM_021.ds4

SD5410

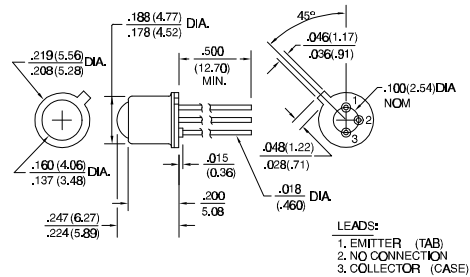

DIM_21b.ds4

SD3410/5410

Silicon Photodarlington

ELECTRICAL CHARACTERISTICS (25°C unless otherwise noted)

PARAMETER	SYMBOL	MIN	TYP	MAX	UNITS	TEST CONDITIONS
Light Current SD3410-001 SD3410-002 SD3410-003 SD3410-004	I_L	0.6 2.0 4.0 8.0			mA	$V_{CE}=5\text{ V}$ $H=2\text{ mW/cm}^2$ (1)
Light Current SD5410-001 SD5410-002 SD5410-003	I_L	2.0 4.0 8.0			mA	$V_{CE}=5\text{ V}$ $H=0.2\text{ mW/cm}^2$ (1)
Collector Dark Current	I_{CE0}			250	nA	$V_{CE}=10\text{ V}$, $H=0$
Collector-Emitter Breakdown Voltage	$V_{(BR)CEO}$	15			V	$I_C=100\text{ }\mu\text{A}$
Emitter-Collector Breakdown Voltage	$V_{(BR)ECO}$	5.0			V	$I_E=100\text{ }\mu\text{A}$
Collector-Emitter Saturation Voltage SD3410 SD5410	$V_{CE(SAT)}$			1.1	V	$I_C=1\text{ mA}$ $H=2\text{ mW/cm}^2$ $H=0.2\text{ mW/cm}^2$
Angular Response (2) SD3410 SD5410	\emptyset		90 12		degr.	$I_F=\text{Constant}$
Rise And Fall Time	t_r, t_f		75		μs	$V_{CC}=5\text{ V}$, $I_L=1\text{ mA}$ $R_L=100\text{ }\Omega$

Notes

- The radiation source is a tungsten lamp operating at a color temperature of 2870°K.
- Angular response is defined as the total included angle between the half sensitivity points.

ABSOLUTE MAXIMUM RATINGS

(25°C Free-Air Temperature unless otherwise noted)

Collector-Emitter Voltage	15 V
Emitter-Collector Voltage	5 V
Power Dissipation	150 mW (1)
Operating Temperature Range	-55°C to 125°C
Storage Temperature Range	-65°C to 150°C
Soldering Temperature (10 sec)	260°C

Notes

- Derate linearly from 25°C free-air temperature at the rate of 1.43 mW/°C.

SCHEMATIC

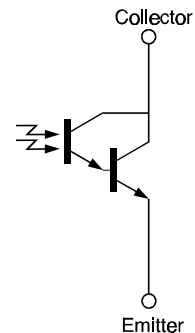

Honeywell reserves the right to make changes in order to improve design and supply the best products possible.

Honeywell

SD3410/5410

Silicon Photodarlington

SWITCHING TIME TEST CIRCUIT

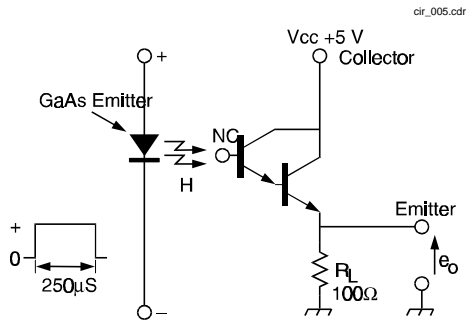

SWITCHING WAVEFORM

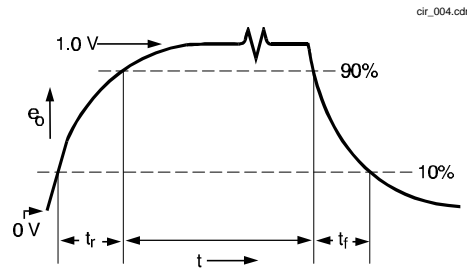

Fig. 1 Responsivity vs Angular Displacement (SD3410)

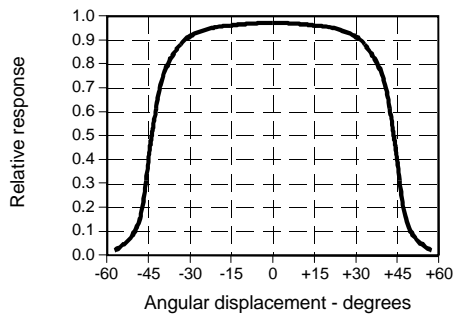

Fig. 2 Responsivity vs Angular Displacement (SD5410)

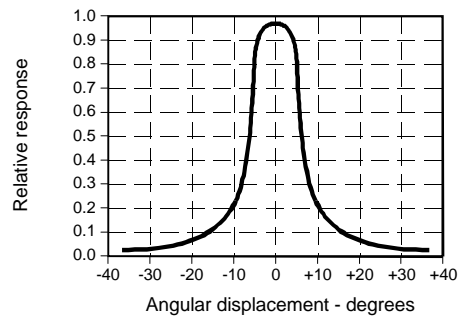

Fig. 3 Non-Saturated Switching Time vs Load Resistance

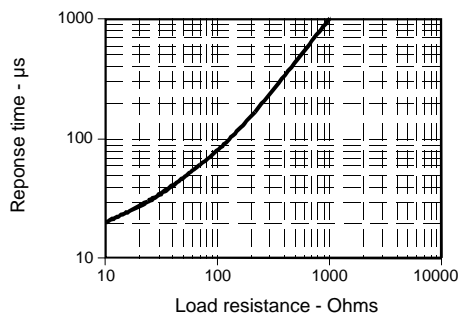
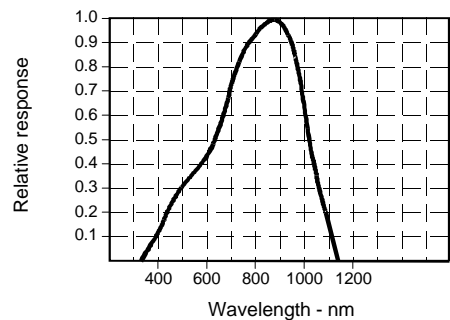

Fig. 4 Spectral Responsivity



All Performance Curves Show Typical Values

SD3410/5410
Silicon Photodarlington





Honeywell reserves the right to make changes in order to improve design and supply the best products possible.

Honeywell

Looking for pricing, stock, or lifecycle information?

Click below to explore more details on WIN SOURCE:

-  [View SD5410-001 on WIN SOURCE](#)
-  [Honeywell Information](#)

Optimize Your Supply Chain with WIN SOURCE Solutions

-  Global Sourcing Solution
-  Obsolete Management
-  Cost Control Management
-  Shortage Management
-  Alternative Solution
-  Excess Inventory Management