

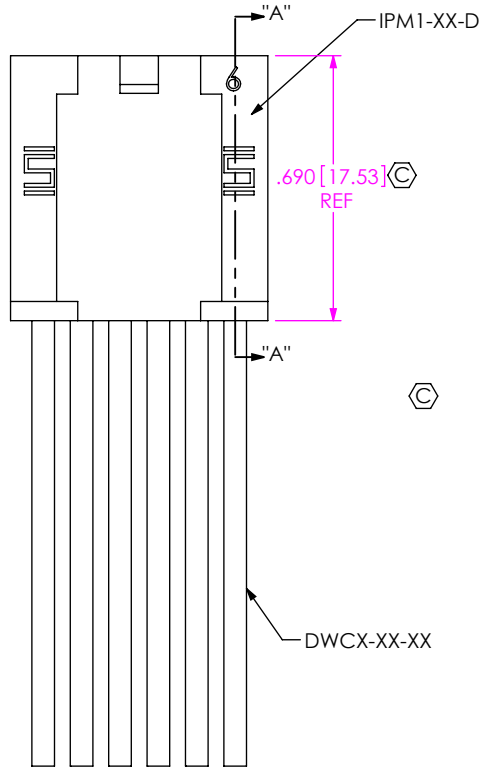

**THE DATASHEET OF  
MMTD-05-22-F-12.00-S**

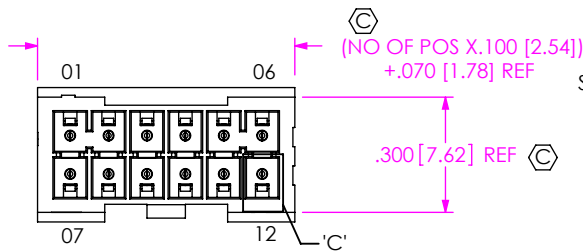

DO NOT SCALE FROM THIS PRINT



ROW OPTION  
 -D: DOUBLE  
 -S: SINGLE (SEE SHT 3, FIG 4)

FEP CABLE OPTION  
 -T: FEP  
 (LEAVE BLANK FOR STANDARD PVC INSULATION) (SEE NOTE 11)

No OF POSITIONS  
 -02 THRU -25 (PER ROW)

WIRE GAUGE (AWG)  
 -20, -22, -24, -26, -28, -30  
 FEP: -20, -24, -28, -30

COLOR CODE  
 -C (SEE TABLE 2)  
 (LEAVE BLANK FOR STANDARD BLACK CABLE)  
 (NOT AVAILABLE WITH PTFE OPTION)

PLATING SPECIFICATION  
 -F: 3μ" SELECTIVE GOLD IN CONTACT AREA, BRIGHT ACID TIN ON TAIL  
 -L: 10μ" SELECTIVE GOLD IN CONTACT AREA, BRIGHT ACID TIN ON TAIL  
 -S: 30μ" SELECTIVE GOLD IN CONTACT AREA, BRIGHT ACID TIN ON TAIL

DOUBLE END OPTIONS  
 [MUST BE USED ON -D END OPTION ONLY & APPLIES TO END 2 HOUSING]  
 -TUS: TRANSFER LATCH UP, STRAIGHT (SEE FIG 2, SHEET 2)  
 -TDS: TRANSFER LATCH DOWN, STRAIGHT (SEE FIG 3, SHEET 2)  
 -LDS: PLASTIC LATCH DOWN, STRAIGHT (SEE FIG 9, SHEET 4)  
 -LUS: PLASTIC LATCH UP, STRAIGHT (SEE FIG 10, SHEET 4)  
 \*-TDX: TRANSFER LATCH DOWN, CROSSED (SEE FIG 11, SHEET 5)  
 \*-LDX: PLASTIC LATCH DOWN, CROSSED (SEE FIG 12, SHEET 5)

POLARIZATION OPTION  
 -G: GUIDE POST (USE IPM1-XX-D-GP) (LEAVE BLANK FOR NO POLARIZATION) (SEE FIG 5 SHEET 3)  
 (ONLY AVAILABLE ON DOUBLE ROW)

END OPTION  
 -S: SINGLE END  
 -D: DOUBLE END (MUST CHOOSE A DOUBLE END OPTION.)

ASSEMBLED LENGTH  
 SPECIFY IN INCHES [USE DWCX-XX-XX]  
 (SINGLE END: 03.00 [76.2] INCH MINIMUM, DOUBLE END: 03.25 [82.6] INCH MINIMUM)

\* = 10 POS MAXIMUM, -07.00 MINIMUM

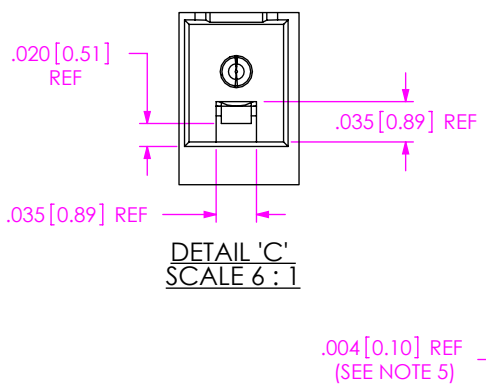

DETAIL 'C'  
 SCALE 6 : 1

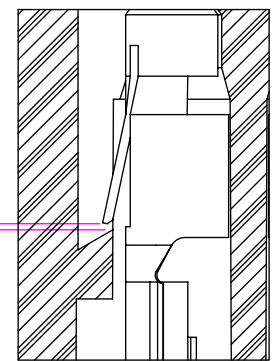

DETAIL 'B'  
 SCALE 8 : 1

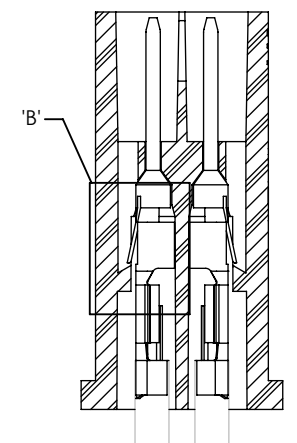

SECTION "A"-A"  
 SCALE 3 : 1

FIG 1  
 MMTD-06-20-X-X-XX.XX-S SHOWN

- NOTES:
1. Ⓢ REPRESENTS A CRITICAL DIMENSION.
  2. NOTE DELETED
  3. NOTE DELETED
  4. MINIMUM PULLOUT FORCE: 0.5 lbs [2.22 N].
  5. CONTACT MUST BE INSERTED UNTIL RETENTION FEATURE LOCKS INTO PLACE.
  6. ALL FINISHED GOODS ARE TO BE ELECTRICAL TESTED INCLUDING HI-POT TEST @ 1000 VOLTS DC. AFTER FINAL ELECTRICAL TEST, MARK EACH ASSEMBLY PER INSTRUCTIONS REFERENCED IN CO-{AD-ID}-WI-3092-M.
  7. TINNED COPPER WIRE IS ROHS COMPLIANT.
  8. PARTS ARE TO BE LAYER PACKAGED.
  9. REFER TO CRIMP SPECIFICATIONS PRINT FOR CRIMP AND STRIP DIMENSIONS, TOLERANCES, TOOLING AND ITS REQUIREMENTS.
  10. FOR LENGTHS LESS THAN 12 IN [304.8], TOLERANCE SHALL BE ± .125 [3.18]. FOR OTHER LENGTHS, TOLERANCES SHALL BE ± 2%.
  11. ASSEMBLIES USING THE FEP OPTION ARE FOR CRIMP APPLICATIONS ONLY.
  12. CUT LENGTH IS ASSEMBLY LENGTH MINUS OVERALL LENGTH SUBTRACTOR.

<p>UNLESS OTHERWISE SPECIFIED, DIMENSIONS ARE IN INCHES. TOLERANCES ARE:</p> <p>DECIMALS ANGLES                  .XX: ±.01 [.3] 2°                  .XXX: ±.005 [.13]                  .XXXX: ±.0020 [.051]</p>	<p>PROPRIETARY NOTE                  THIS DOCUMENT CONTAINS CONFIDENTIAL AND PROPRIETARY INFORMATION AND ALL DESIGN, MANUFACTURING, REPRODUCTION, USE, PATENT RIGHTS AND SALES RIGHTS ARE EXPRESSLY RESERVED BY SAMTEC, INC. THIS DOCUMENT SHALL NOT BE DISCLOSED, IN WHOLE OR PART, TO ANY UNAUTHORIZED PERSON OR ENTITY NOR REPRODUCED, TRANSFERRED OR INCORPORATED IN ANY OTHER PROJECT IN ANY MANNER WITHOUT THE EXPRESS WRITTEN CONSENT OF SAMTEC, INC.</p>	 <p>520 PARK EAST BLVD, NEW ALBANY, IN 47150                  PHONE: 812-944-6733 FAX: 812-948-5047                  e-Mail: info@SAMTEC.com code: 55322</p>
<p>MATERIAL: DO NOT SCALE DRAWING                  HOUSING: NYLON 6/6, COLOR: WHITE                  CONTACT: PHOS BRONZE                  CABLE: INSULATION: SEE CALLOUT                  WIRE: TINNED COPPER</p>	<p>SHEET SCALE: 2:1</p>	<p>DESCRIPTION:                  .100 [2.54] TERMINAL DISCRETE CABLE ASSEMBLY</p> <p>DWG. NO.                  MMTXX-XX-XX-X-X-XX.XX-X-X-XXX</p>
<p>F:\DWG\MISC\MKTG\MMTX-XX-XX-X-X-XX.XX-X-X-XXX-MKT.SLDDRW</p>		<p>BY: D. SCHMELZ 12/04/2008 SHEET 1 OF 5</p>

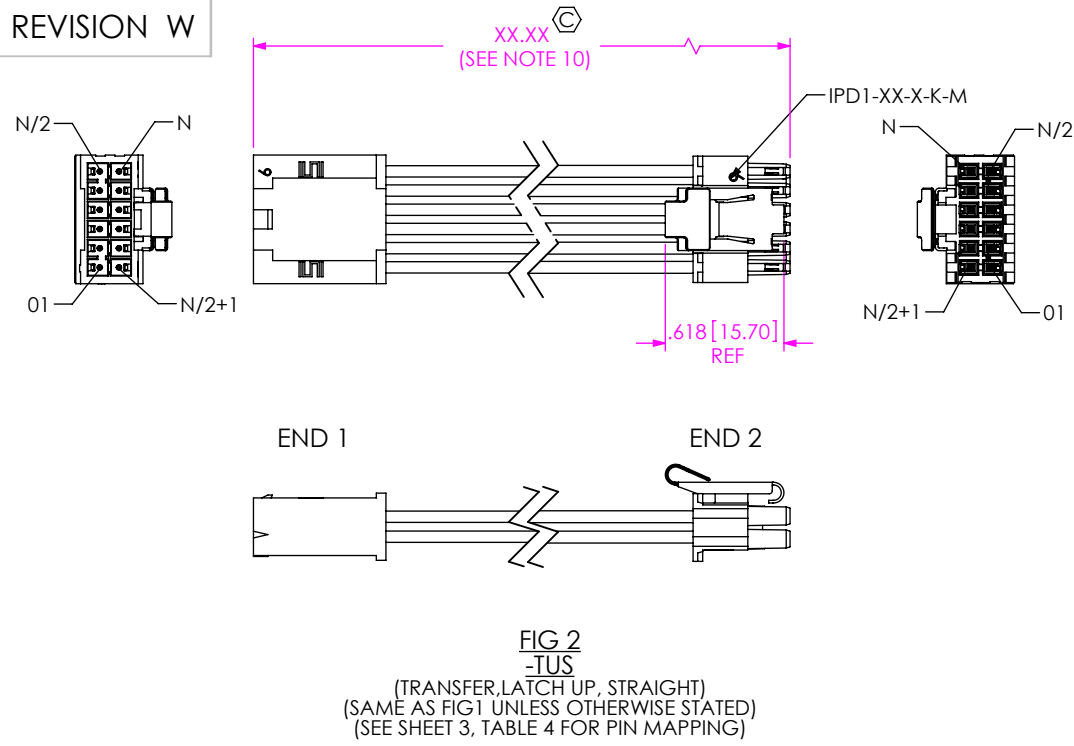

**FIG 2**  
-TUS  
(TRANSFER, LATCH UP, STRAIGHT)  
(SAME AS FIG 1 UNLESS OTHERWISE STATED)  
(SEE SHEET 3, TABLE 4 FOR PIN MAPPING)

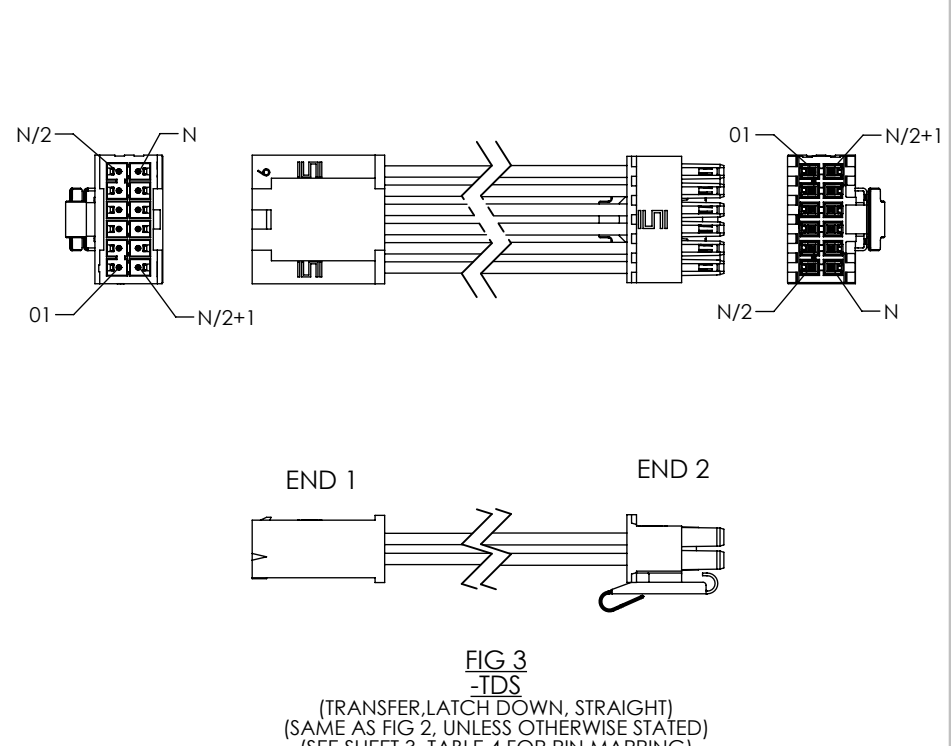

**FIG 3**  
-TDS  
(TRANSFER, LATCH DOWN, STRAIGHT)  
(SAME AS FIG 2, UNLESS OTHERWISE STATED)  
(SEE SHEET 3, TABLE 4 FOR PIN MAPPING)

**TABLE 2**

**MMTXX COLOR CODED WIRE SEQUENCE**

PIN #	COLOR									
	BROWN	RED	ORANGE	YELLOW	GREEN	BLUE	VIOLET	GRAY	WHITE	BLACK
	DWC-XX-01-300	DWC-XX-02-300	DWC-XX-03-300	DWC-XX-04-300	DWC-XX-05-300	DWC-XX-13-300	DWC-XX-07-300	DWC-XX-08-300	DWC-XX-09-300	DWC-XX-10-300
1	2	3	4	5	6	7	8	9	10	
11	12	13	14	15	16	17	18	19	20	
21	22	23	24	25	26	27	28	29	30	
31	32	33	34	35	36	37	38	39	40	
41	42	43	44	45	46	47	48	49	50	

**TABLE 1**

SERIES	WIRE GAUGE	CABLE	TERMINAL	CONTACT
MMTXX	20 AWG	DWC-20-XX-300	T-1M74-02-X	C-179-03-X
MMTXX	22 AWG	DWC-22-XX-300	T-1M74-02-X	C-179-03-X
MMTXX	24 AWG	DWC-24-XX-300	T-1M74-02-X	C-179-03-X
MMTXX	26 AWG	DWC-26-XX-300	T-1M74-01-X	C-179-02-X
MMTXX	28 AWG	DWC-28-XX-300	T-1M74-01-X	C-179-02-X
MMTXX	30 AWG	DWC-30-XX-300	T-1M74-01-X	C-179-02-X
MMTXX	20 AWG	DWCT-20-XX-TC	T-1M74-02-X	C-179-03-X
MMTXX	24 AWG	DWCT-24-XX-TC	T-1M74-02-X	C-179-03-X
MMTXX	28 AWG	DWCT-28-XX-TC	T-1M74-03-X	C-179-04-X
MMTXX	30 AWG	DWCT-30-XX-TC	T-1M74-03-X	C-179-04-X

**PROPRIETARY NOTE**  
THIS DOCUMENT CONTAINS CONFIDENTIAL AND PROPRIETARY INFORMATION AND ALL DESIGN, MANUFACTURING, REPRODUCTION, USE, PATENT RIGHTS AND SALES RIGHTS ARE EXPRESSLY RESERVED BY SAMTEC, INC. THIS DOCUMENT SHALL NOT BE DISCLOSED, IN WHOLE OR PART, TO ANY UNAUTHORIZED PERSON OR ENTITY NOR REPRODUCED, TRANSFERRED OR INCORPORATED IN ANY OTHER PROJECT IN ANY MANNER WITHOUT THE EXPRESS WRITTEN CONSENT OF SAMTEC, INC.

DO NOT SCALE DRAWING  
SHEET SCALE: 2:1



520 PARK EAST BLVD, NEW ALBANY, IN 47150  
PHONE: 812-944-6733 FAX: 812-948-5047  
e-Mail: info@SAMTEC.com code: 55322

DESCRIPTION:  
.100[2.54] TERMINAL DISCRETE CABLE ASSEMBLY  
DWG. NO.  
MMTXX-XX-XX-X-X-XX.XX-X-X-XXX  
BY: D. SCHMELZ 12/04/2008 SHEET 2 OF 5

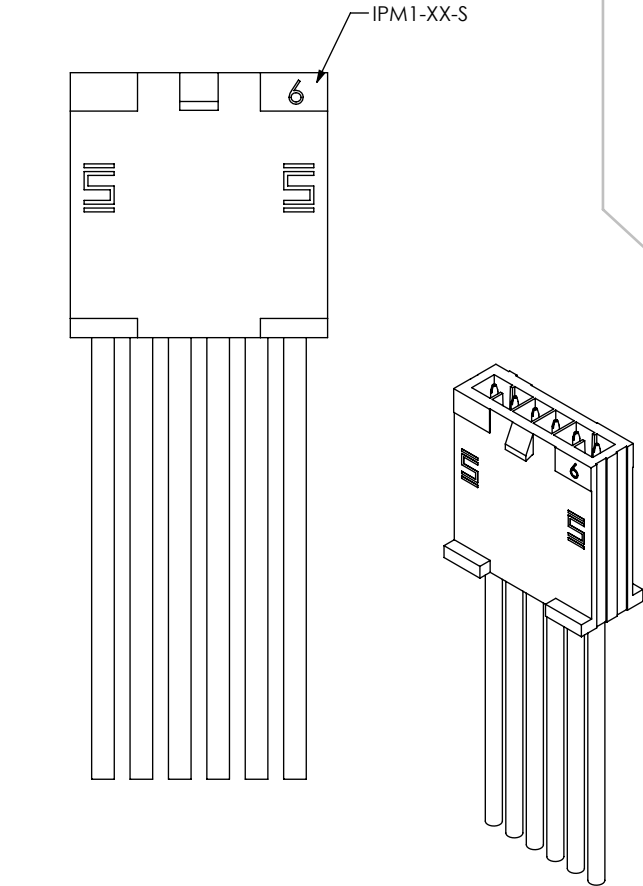
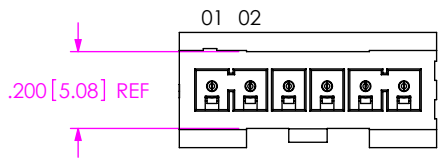

FIG 4  
MMTS-06-20-X-XX-XX-S SHOWN  
(DIFFERENT AS SHOWN, OTHERWISE SAME AS FIG 1)

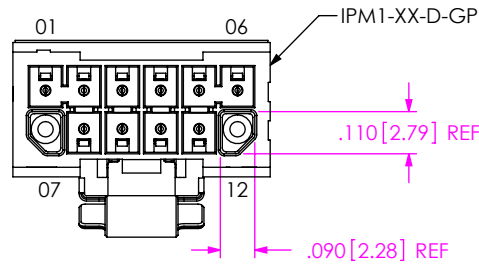

FIG 5  
MMTD-06-20-X-X-XX-XX-G-S SHOWN  
(DIFFERENT AS SHOWN, OTHERWISE SAME AS FIG 1)

TABLE 4			
PIN MAPPING			
ROW OPTION	END OPTION	END 1	END 2
SINGLE	-TUS, -LUS	01	01
	-TDS, -LDS	01	N
	-TDX, -LDX	01	01
DOUBLE	-TUS, -LUS	01	01
	-TDS, -LDS	01	N
	-TDX, -LDX	01	01

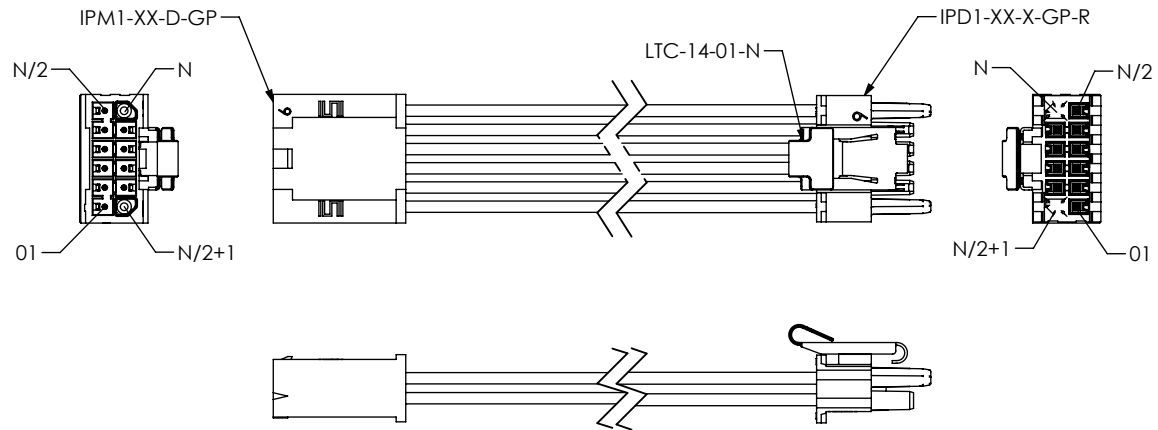

FIG 6  
MMTD-06-20-X-X-XX-XX-G-TUS SHOWN  
(DIFFERENT AS SHOWN, OTHERWISE SAME AS FIG 1)  
(SEE TABLE 4 FOR PIN MAPPING)

**PROPRIETARY NOTE**  
THIS DOCUMENT CONTAINS CONFIDENTIAL AND PROPRIETARY INFORMATION AND ALL DESIGN, MANUFACTURING, REPRODUCTION, USE, PATENT RIGHTS AND SALES RIGHTS ARE EXPRESSLY RESERVED BY SAMTEC, INC. THIS DOCUMENT SHALL NOT BE DISCLOSED, IN WHOLE OR PART, TO ANY UNAUTHORIZED PERSON OR ENTITY NOR REPRODUCED, TRANSFERRED OR INCORPORATED IN ANY OTHER PROJECT IN ANY MANNER WITHOUT THE EXPRESS WRITTEN CONSENT OF SAMTEC, INC.

DO NOT SCALE DRAWING

SHEET SCALE: 2:1



520 PARK EAST BLVD, NEW ALBANY, IN 47150  
PHONE: 812-944-6733 FAX: 812-948-5047  
e-Mail: info@SAMTEC.com code: 55322

DESCRIPTION:  
.100[2.54] TERMINAL DISCRETE CABLE ASSEMBLY

DWG. NO.  
MMTXX-XX-XX-X-X-XX-XX-X-X-XXX

BY: D. SCHMELZ 12/04/2008 SHEET 3 OF 5

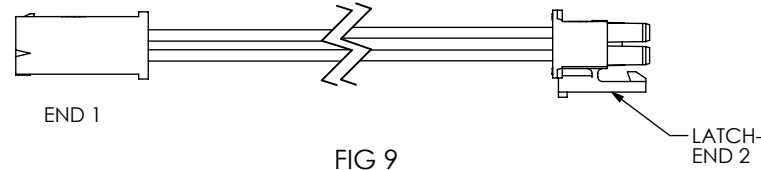
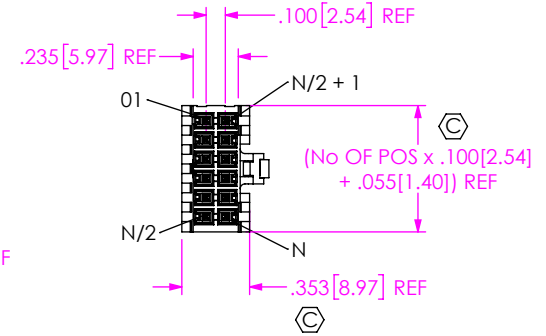
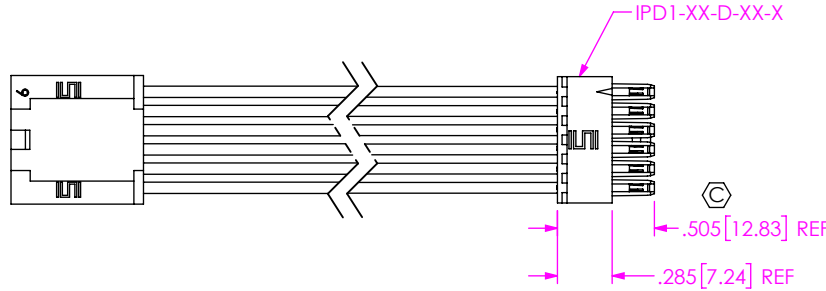
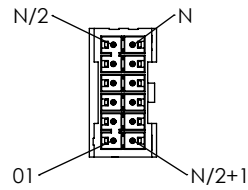

**FIG 9**  
-LDS  
(TRANSFER, LATCH DOWN, STRAIGHT)  
(DIFFERENT AS SHOWN, OTHERWISE SAME AS FIG 2)  
(SEE SHEET 3, TABLE 4 FOR PIN MAPPING)

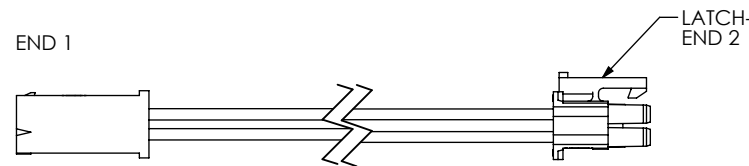
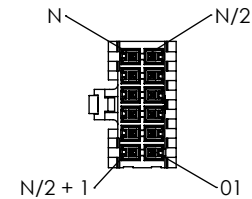
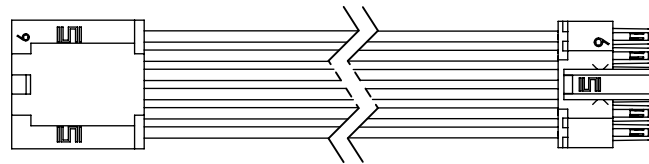
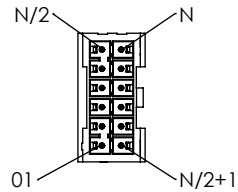

**FIG 10**  
-LUS  
(TRANSFER, LATCH UP, STRAIGHT)  
(DIFFERENT AS SHOWN, OTHERWISE SAME AS FIG 2 & 9)  
(SEE SHEET 3, TABLE 4 FOR PIN MAPPING)

**PROPRIETARY NOTE**  
THIS DOCUMENT CONTAINS CONFIDENTIAL AND PROPRIETARY INFORMATION AND ALL DESIGN, MANUFACTURING, REPRODUCTION, USE, PATENT RIGHTS AND SALES RIGHTS ARE EXPRESSLY RESERVED BY SAMTEC, INC. THIS DOCUMENT SHALL NOT BE DISCLOSED, IN WHOLE OR PART, TO ANY UNAUTHORIZED PERSON OR ENTITY NOR REPRODUCED, TRANSFERRED OR INCORPORATED IN ANY OTHER PROJECT IN ANY MANNER WITHOUT THE EXPRESS WRITTEN CONSENT OF SAMTEC, INC.

DO NOT SCALE DRAWING

SHEET SCALE: 2:1



520 PARK EAST BLVD, NEW ALBANY, IN 47150  
PHONE: 812-944-6733 FAX: 812-948-5047  
e-Mail: info@SAMTEC.com code: 55322

DESCRIPTION:  
.100[2.54] TERMINAL DISCRETE CABLE ASSEMBLY

DWG. NO.  
MMTXX-XX-XX-X-X-XX.XX-X-X-XXX

BY: D. SCHMELZ12/04/2008 SHEET 4 OF 5

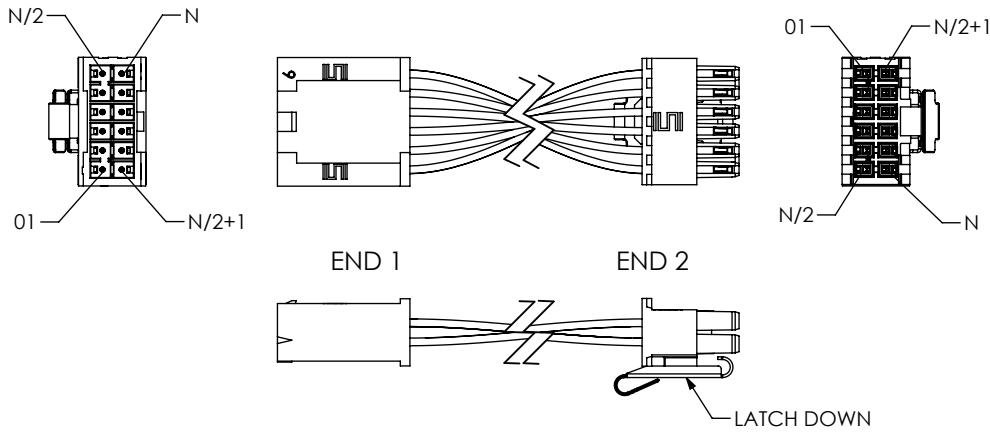

**FIG 12**  
**-TDX**  
 (TRANSFER, LATCH DOWN, CROSSED)  
 (SAME AS FIG 2, UNLESS OTHERWISE STATED)  
 (SEE SHEET 3, TABLE 4 FOR PIN MAPPING)

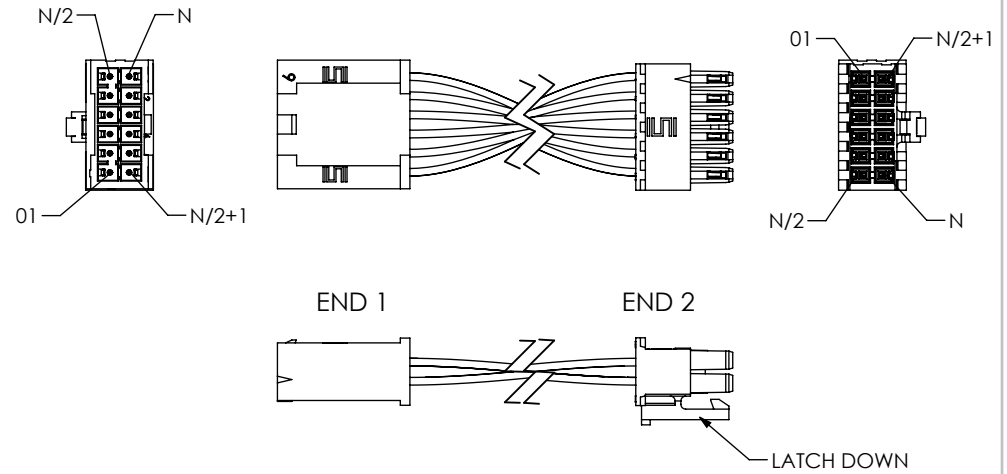

**FIG 14**  
**-LDX**  
 (TRANSFER, LATCH DOWN, CROSSED)  
 (DIFFERENT AS SHOWN, OTHERWISE SAME AS FIG 2)  
 (SEE SHEET 3, TABLE 4 FOR PIN MAPPING)

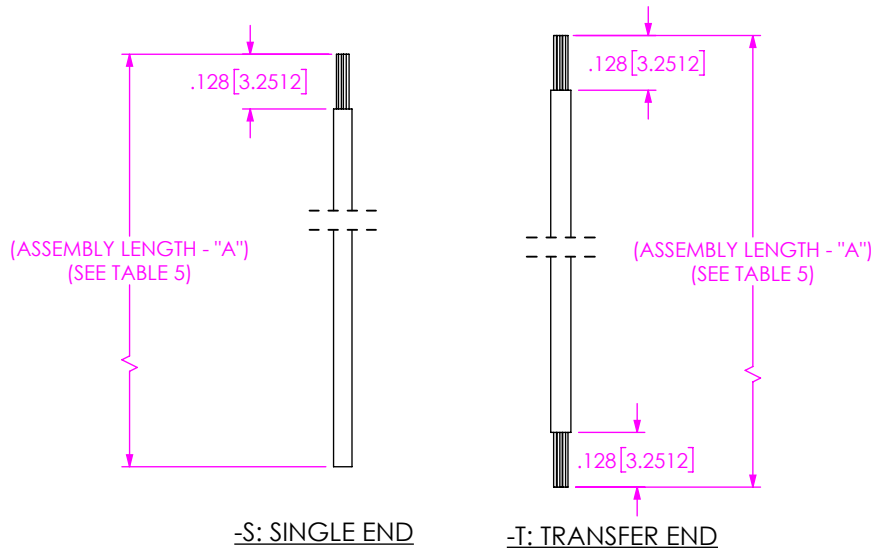

CABLE CUT IN-PROCESS

TABLE 5 ( OVERALL LENGTH SUBTRACTORS) (SEE NOTE 12)	
	"A"
-S: SINGLE END	.464 [11.79]
-T: TRANSFER END	.714 [18.14]

**PROPRIETARY NOTE**  
 THIS DOCUMENT CONTAINS CONFIDENTIAL AND PROPRIETARY INFORMATION AND ALL DESIGN, MANUFACTURING, REPRODUCTION, USE, PATENT RIGHTS AND SALES RIGHTS ARE EXPRESSLY RESERVED BY SAMTEC, INC. THIS DOCUMENT SHALL NOT BE DISCLOSED, IN WHOLE OR PART, TO ANY UNAUTHORIZED PERSON OR ENTITY NOR REPRODUCED, TRANSFERRED OR INCORPORATED IN ANY OTHER PROJECT IN ANY MANNER WITHOUT THE EXPRESS WRITTEN CONSENT OF SAMTEC, INC.

DO NOT SCALE DRAWING  
 SHEET SCALE: 2:1



520 PARK EAST BLVD, NEW ALBANY, IN 47150  
 PHONE: 812-944-6733 FAX: 812-948-5047  
 e-Mail: info@SAMTEC.com code: 55322

DESCRIPTION:  
 .100[2.54] TERMINAL DISCRETE CABLE ASSEMBLY

DWG. NO.  
 MMTXX-XX-XX-X-X-XX.XX-X-X-XXX

BY: D. SCHMELZ 12/04/2008 SHEET 5 OF 5

## Looking for pricing, stock, or lifecycle information?

Click below to explore more details on WIN SOURCE:

 [View MMTD-05-22-F-12.00-S on WIN SOURCE](#)

 [Samtec Inc. Information](#)

## Optimize Your Supply Chain with WIN SOURCE Solutions

-  Global Sourcing Solution
-  Obsolete Management
-  Cost Control Management
-  Shortage Management
-  Alternative Solution
-  Excess Inventory Management