



**THE DATASHEET OF
MLX91209LVA-CAA-001-SP**



1. Features and Benefits

- Programmable high speed current sensor
- Programmable linear transfer characteristic
- Selectable analog ratiometric output
- Measurement range from 15 to 450mT
- Single die VA package RoHS compliant
- Wideband: DC to 250kHz
- Short response time 2μsec
- Lead free component, suitable for lead free soldering profile 260°C (target), MSL1
- AEC-Q100 Automotive Qualified



2. Application Examples

- Inverter applications in HEV and EV
- BLDC motor current monitoring
- AC/DC converters
- Over current detection circuit

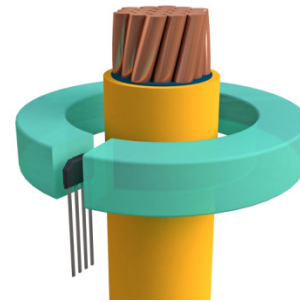

Figure 1: Typical Current Sensing Application

3. General Description

The MLX91209 is a monolithic programmable Hall sensor IC featuring the planar Hall technology, which is sensitive to the flux density applied orthogonally to the IC surface. The sensor provides an output signal proportional to the applied magnetic flux density and is preferably suited for current measurement. The transfer characteristic of the MLX91209 is programmable (offset, gain). The linear analog output is designed for applications

where a very fast response is required, such as inverter applications.

In a typical application, the sensor is used in combination with a ring shaped soft ferromagnetic core. The Hall IC is placed in a small air gap and the current conductor is passed through the inner part of the ferromagnetic ring. The ring concentrates and amplifies the magnetic flux on the Hall sensor IC, which generates an output voltage proportional to the current flowing in the conductor.

4. Ordering Information

Product	Temperature	Package	Option Code	Packing Form	Default Sensitivity
MLX91209	L (-40°C to 150°C)	VA	CAA - 000	BU/CR	50 mV/mT (prog: 5..150mV/mT)
MLX91209	L (-40°C to 150°C)	VA	CAA - 001	BU/CR	15 mV/mT (prog: 5..150mV/mT)
MLX91209	L (-40°C to 150°C)	VA	CAA - 002	BU/CR	7.3 mV/mT (prog: 5..150mV/mT)
MLX91209	L (-40°C to 150°C)	VA	CAA - 003	BU/CR	19 mV/mT (prog: 5..150mV/mT)
MLX91209	L (-40°C to 150°C)	VA	CAA - 005	BU/CR	8.78mV/mT (prog: 5..150mV/mT)
MLX91209	L (-40°C to 150°C)	VA	CAA - 006	BU/CR	6.9 mV/mT (prog: 5..150mV/mT)

Table 1: Ordering Information

Contents

1. Features and Benefits.....	1
2. Application Examples	1
3. General Description.....	1
4. Ordering Information	1
5. Functional Diagram	2
6. Glossary of Terms.....	4
7. Absolute Maximum Ratings.....	5
8. Pin Definitions and Descriptions.....	5
9. General Electrical Specifications.....	6
10. Magnetic specification	6
10.1. Sensor active measurement direction.....	7
11. Analog output specification.....	7
11.1. Timing specification.....	7
11.2. Accuracy specification	8
11.3. Remarks to the achievable accuracy	8
12. Programmable items	9
12.1. Parameter table.....	9
12.2. Sensitivity programming (RG, FG)	9
12.3. Offset / output quiescent voltage programming (VOQ)	9
12.4. Output ratiometry (ENRATIO)	9
12.5. Sensitivity temperature drift programming (TC1, TC2COLD, TC2HOT)	10
12.6. Offset temperature drift programming (OFFDR2C, OFFDR2H)	10
12.7. Noise filter (NOISEFILT).....	10
12.8. Identification code (ID).....	10
13. Self-diagnostic.....	11
14. Recommended Application Diagrams.....	12
14.1. Resistor and capacitor values.....	12
14.2. Pull down resistor for diagnostic low	12
15. Typical performance.....	13
16. Standard information regarding manufacturability of Melexis products with different soldering processes.....	14
17. ESD Precautions	15
18. FAQ	15
Package Information	15
19.....	15
19.1. Package Marking & Hall Plate Position.....	15
19.2. VA / SIP 4L (single in-line package).....	16
19.3. Trim and form type: 90° 2x2x91.3 (h=5.34mm); Bending-STD2 (CAR-xxx)	17
19.4. Trim and form type: SMD style TFT4K1 (CAZ-xxx).....	18
20. Contact.....	19
21. Disclaimer.....	19

6. Glossary of Terms

Terms	Definition
Tesla	Units for the magnetic flux density, 1 mT = 10 Gauss
TC	Temperature Coefficient in ppm/deg C
NC	Not Connected
ADC	Analog to Digital Converter
DAC	Digital to Analog Converter
LSB	Least Significant Bit
MSB	Most Significant Bit
DNL	Differential Non Linearity
INL	Integral Non Linearity
IMC	Integrated Magneto Concentrator (IMC-Hall®)
PTC	Programming Through Connector

Table 3: Glossary of Terms

7. Absolute Maximum Ratings

Parameter	Symbol	Value	Units
Positive Supply Voltage (overvoltage)	Vdd	+10	V
Reverse Supply Voltage Protection		-0.3	V
Positive Output Voltage ⁽¹⁾		+10	V
Output Current	Iout	±70	mA
Reverse Output Voltage		-0.3	V
Reverse Output Current		-50	mA
Package Thermal Resistance <i>(junction-to-ambient) θ_{ja} is defined according JEDEC 1s0p board</i>	θ_{ja}	205	°C/W
Operating Ambient Temperature Range	T _A	-40 to +150	°C
Storage Temperature Range	T _S	-55 to +165	°C
Magnetic Flux Density		±3	T
Maximum Junction Temperature		-55 to 155	°C
ESD – Human Body Model <i>(applicable for all pins)</i>		2	kV

Table 4: Absolute maximum ratings

Exceeding the absolute maximum ratings may cause permanent damage. Exposure to absolute maximum rated conditions for extended periods may affect device reliability.

(1) Valid for supply=10V or supply-pin floating.

8. Pin Definitions and Descriptions

Pin №	Name	Type	Function
1	VDD	Supply	Supply Voltage
2	OUT	Analog	Current Sensor Output
3	TEST/MUST	Digital	Test and Factory Calibration
4	GND	Ground	Supply Voltage

Table 5: Pin definitions and descriptions

It is recommended to connect the TEST/MUST pin to the Ground for optimal EMC performance.

9. General Electrical Specifications

Operating Parameters: $T_A = -40^{\circ}\text{C}$ to 125°C , $V_{dd} = 4.5\text{V}$ to 5.5V , $I_{out} = -2\text{mA}$ to 2mA , recommended application diagram, unless otherwise specified.

Parameter	Symbol	Test Conditions	Min	Typ	Max	Units
Nominal Supply Voltage	V_{dd}		4.5	5	5.5	V
Supply Current	I_{dd}	No output load, application mode, $T_A = -40^{\circ}\text{C}$ to 150°C	9	12	14	mA
DC Load Current	I_{out}	R_{load} in range [6k Ω , 100k Ω]	-2		2	mA
Maximum Output Current (driving capability)	I_{max}	Inside this range, output voltage reaches 3 and 97% V_{dd}	-2		2	mA
Output Resistance		$V_{out} = 50\% V_{dd}$, $R_L = 6\text{k}\Omega$		1	5	Ω
Output Capacitive Load	C_{load}	Output amplifier is optimized for the capacitive load range.	1		10	nF
Output Resistive Load (pull-down resistor)	R_{load}	Output resistive load for high linearity	6			k Ω
Output Short Circuit Current (Permanent)	I_{short}	Output shorted permanent to V_{dd} Output shorted permanent to GND				Not destroyed Not destroyed
Output Leakage current	I_{leak}	High impedance mode ⁽¹⁾ $T_A = 150^{\circ}\text{C}$			20	μA
Linear Output Voltage Range <i>Vout in [10%Vdd, 90%Vdd]</i>	V_{out_pd}	pull-down $\geq 10\text{ k}\Omega$	10		90	%Vdd
High-impedance mode levels ⁽¹⁾	$V_{out_HiZ_pd}$	pull-down $R_L \leq 25\text{ k}\Omega$, $T \leq 125^{\circ}\text{C}$			5	%Vdd
Under-voltage detection ⁽²⁾	V_{dd_uvd}	Low to High Voltage	3.0	3.3	4.0	V
	V_{dd_uvh}	Hysteresis	0.2	0.3	0.45	V
Ratiometry enable detection	V_{ratio_d}	Low to High Voltage	4		4.5	V
	V_{ratio_h}	Hysteresis	0.01		0.5	V
Over-voltage detection ⁽²⁾	V_{dd_ovd}	Low to High Voltage	6.5		7.6	V
	V_{dd_ovh}	Hysteresis	0.05		0.7	V

Table 6: General electrical parameters

(1) Refer to section *Self-diagnostic*, Table 11.

(2) According to the following diagram:

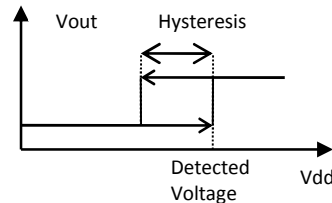

10. Magnetic specification

Operating Parameters $T_A = -40^{\circ}\text{C}$ to 125°C , $V_{dd} = 4.5\text{V}$ to 5.5V , unless otherwise specified.

Parameter	Symbol	Test Conditions / Comments	Min	Typ	Max	Units
Magnetic field range	B		± 15		± 450	mT
Linearity Error	NL	V_{dd} in range [4.5V, 5.5V] V_{out} in [10% V_{dd} , 90% V_{dd}]	-0.4		+0.4	%FS
Programmable Sensitivity	S		5		150	mV/mT
Sensitivity programming Resolution	S_{res}			0.1		%

Table 7: Magnetic specification

10.1. Sensor active measurement direction

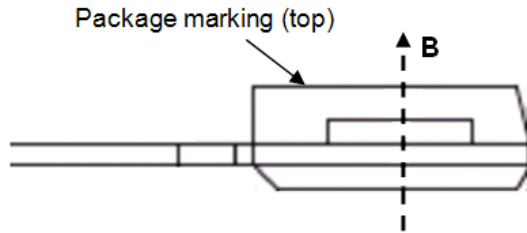

Figure 3: Magnetic Field Direction

11. Analog output specification

11.1. Timing specification

Operating Parameters $T_A = -40^{\circ}\text{C}$ to 125°C , $V_{dd} = 4.5\text{V}$ to 5.5V (unless otherwise specified).

Parameter	Symbol	Test Conditions / Comments	Min	Typ	Max	Units
Refresh rate	Trr		0.8	1	2	μs
Step Response Time	Tresp	Delay between the input signal reaching 90% and the output signal reaching 90%, (2V step at the output, input rise time = $1\mu\text{s}$) -Noise filter OFF -Noise filter ON		2	3	μs
				5	6	μs
Bandwidth	BW	-Noise filter OFF		250		kHz
		-Noise filter ON		70		kHz
Power on Delay	T_{POD}	$V_{\text{out}} = 100\%$ of FS Pull-down resistor $\leq 100\text{k}\Omega$ During the Power-on delay, output will remain within the 10% fault band at all time.			1	ms
Ratiometry Cut-off Frequency	Fratio			250		Hz

Table 8: Timing specification for high speed analog output

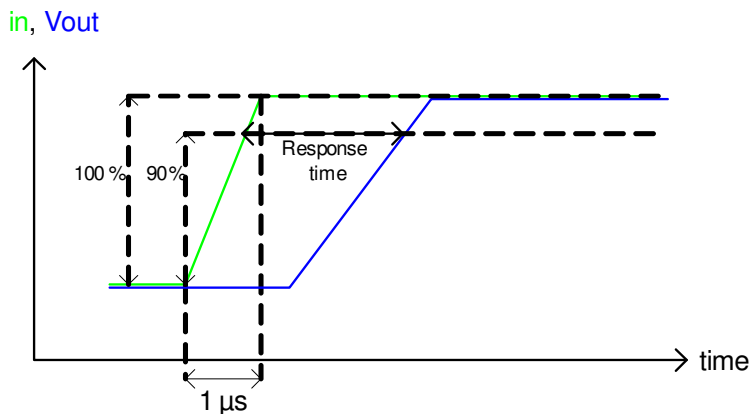

Figure 4: Response time definition

11.2. Accuracy specification

Operating Parameters $T_A = -40^{\circ}\text{C}$ to 125°C , $V_{dd} = 4.5\text{V}$ to 5.5V (unless otherwise specified).

Parameter	Symbol	Test Conditions	Min	Typ.	Max	Units
Thermal Offset Drift ⁽¹⁾	$\Delta^T\text{Voq}$	In ref. to $T = 35^{\circ}\text{C}$ $V_{dd} = 5\text{V}$ $\text{Voq} = 50 \pm 0.2 \%V_{dd}$	-10		10	mV
Thermal Sensitivity Drift	TC	In ref. to $T = 35^{\circ}\text{C}$ $V_{dd} = 5\text{V}$	-1.5	0	+1.5	% of S
RMS Output noise ⁽²⁾	N_{rms}	$S = 50\text{mV/mT}$			10	mVrms
		-Noise filter OFF			6	mVrms
		$S = 7.3\text{mV/mT}$		2.8		mVrms
		-Noise filter ON		1.9		mVrms
Ratiometry Error Offset	ΔVoq	$\text{Voq} = 50\%V_{dd}$ $\Delta V_{dd} = 10\%V_{dd}$	-0.4		+0.4	% of Voq
Ratiometry Error Sensitivity	ΔS	$\Delta V_{dd} = 10\%V_{dd}$	-0.4		+0.4	% of S

Table 9: Accuracy specification for high speed analog output

- (1) Thermal offset drift specification is only valid when ENRATIO and PLATEPOL parameters are kept in their default configuration.
- (2) The RMS Output Noise depends on the factory sensitivity [mV/mT].

11.3. Remarks to the achievable accuracy

The achievable target accuracy depends on end-of-line calibration in the application. Resolution for offset calibration is better than $0.1\%V_{dd}$. Trimming capability is higher than measurement accuracy. End-of-line calibration can increase overall system accuracy.

12. Programmable items

12.1. Parameter table

Parameter	Bits	Factory Setting	Comment
VOQ[11:0]	12	trimmed	Quiescent output level (0 Gauss) adjustment
RG[2:0]	3	trimmed	Rough gain adjustment
FG[9:0]	10	trimmed	Fine gain adjustment
ENRATIO	1	1	Ratiometry enablement
TC1[7:0]	8	trimmed	Adjustment of the first order temperature compensation of the magnetic sensitivity
TC2HOT[4:0]	5	trimmed	Adjustment of the extra temperature compensation of the magnetic sensitivity at high temperature
TC2COLD[4:0]	5	trimmed	Adjustment of the extra temperature compensation of the magnetic sensitivity at low temperature
OFFDR2C[5:0]	6	trimmed	Adjustment of the offset drift at low temperature after the VGA
OFFDR2H[5:0]	6	trimmed	Adjustment of the offset drift at high temperature after the VGA
NOISEFILT ¹	1	0 1	0 : Noise filter deactivated 1 : Noise filter enabled
ID[47:0]	48	Programmed	Melexis traceability ID

Table 10: Customer programmable items

12.2. Sensitivity programming (RG, FG)

The sensitivity can be programmed from 5 to 150 mV/mT, with the ROUGHGAIN (3 bits) and FINEGAIN (10 bits) parameters.

12.3. Offset / output quiescent voltage programming (VOQ)

The offset is programmable with 12 bits in 1.5 mV steps over the full output range. This corresponds to a calibration resolution of 0.03 %VDD. (The typical step would be $5V/4096 = 1.22$ mV, the actual step size can differ from the nominal value because of internal gain tolerance. The maximum step size of 1.5 mV is guaranteed).

Note: for optimal performance over temperature, VOQ should be programmed in the range 2 to 3V.

12.4. Output ratiometry (ENRATIO)

The ratiometry of the output versus the supply can be disabled by setting this bit to 0.

Note: for optimal performance over temperature, ratiometry should always be enabled (ENRATIO=1).

¹ Noise Filter enabled by default (NOISEFILT = 1) in MLX91209LVA-CAA-003. All other option codes use NOISEFILT = 0 in their default configuration

12.5. Sensitivity temperature drift programming (TC1, TC2COLD, TC2HOT)

First order sensitivity temperature drift can be trimmed from -2000 to 2000ppm/K with TC1. The programming resolution is 40ppm/K.

Second order sensitivity temperature drift can be trimmed from TC2COLD and TC2HOT. The programming resolution is 2ppm/K² for TC2COLD and 0.6ppm/K² for TC2HOT. The second order can also be seen as third order correction since cold and hot sides are independently adjusted.

Note: for optimal performance over temperature, the first order sensitivity drift compensation (TC1ST) should not exceed ± 500 ppm/K.

12.6. Offset temperature drift programming (OFFDR2C, OFFDR2H)

Offset temperature drift caused by the output amplifier can be compensated with these two parameters. This first order correction is done independently for temperatures over and below 25°C.

Note: two additional parameters (OFFDR1C, OFFDR1H) are calibrated by Melexis to compensate for the offset temperature drift caused by the Hall element (before the variable gain amplifier). These parameters should not be adjusted on customer-side.

12.7. Noise filter (NOISEFILT)

Setting this bit to 1 enables the noise filter, reducing noise and increasing response time.

12.8. Identification code (ID)

48 bits programmable identification code.

13. Self-diagnostic

The MLX91209 provides self-diagnostic features to detect internal memory errors and over- / under-voltage conditions. These features increase the robustness of the IC functionality, as they prevent erroneous output signal in case of internal or external failure modes.

Error	Action	Effect on Outputs	Remarks
Calibration Data CRC Error (at power up and in normal working mode)	Fault mode	High Impedance mode	Pull down resistive load => Diag Low
Power On delay		High Impedance mode	5ms max in high impedance followed by settling
Undervoltage Mode	IC is reset	High Impedance mode	300mV Hysteresis (typical)
Overvoltage detection	IC is reset	High Impedance mode	500mV Hysteresis (typical)

Table 11: Self diagnostic

14. Recommended Application Diagrams

14.1. Resistor and capacitor values

Part	Description	Value	Unit
C1	Supply capacitor, EMI, ESD	100	nF
C2	Decoupling, EMI, ESD	1-10 ⁽¹⁾	nF
R1	Pull-down resistor	6-100	kΩ

Table 12: Recommended Resistors and Capacitors Values

(1) 10nF is recommended for better EMC and ESD performance.

14.2. Pull down resistor for diagnostic low

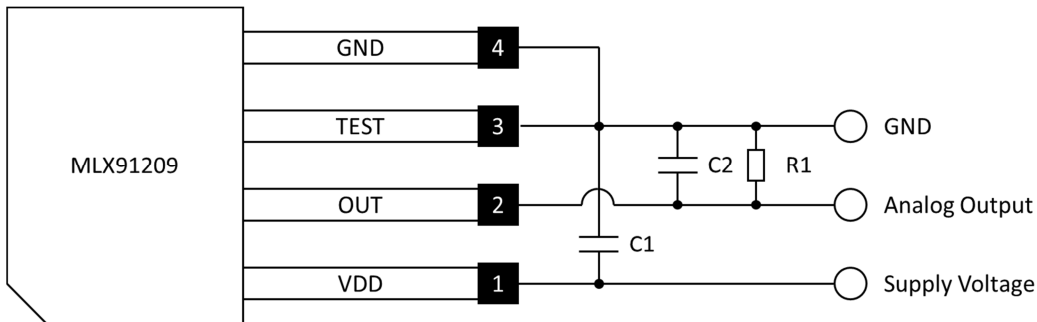

Figure 5: Diagnostic low

15. Typical performance

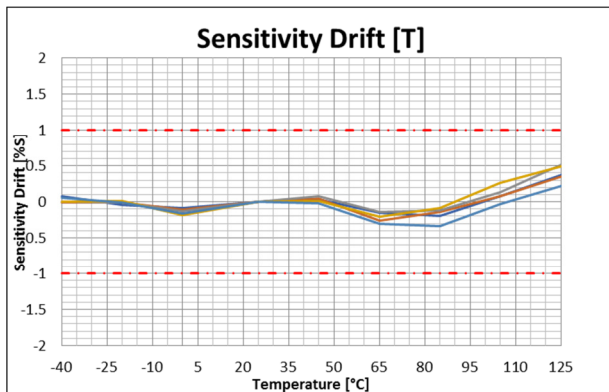

Figure 6: Thermal sensitivity drift.

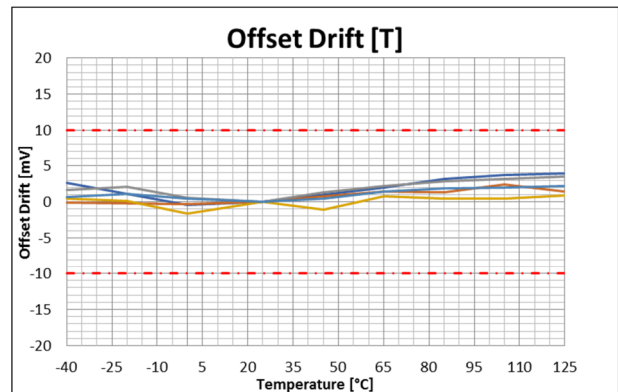

Figure 7: Thermal offset drift

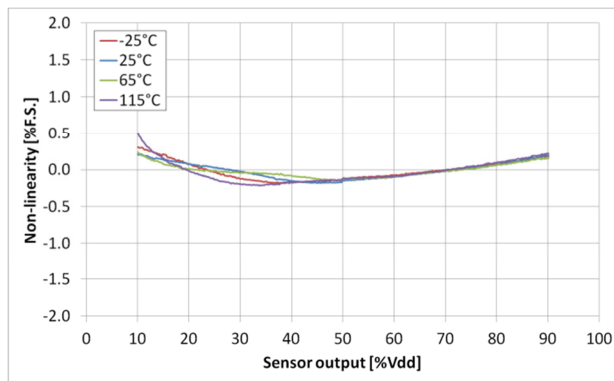

Figure 8: Non-linearity over temperature

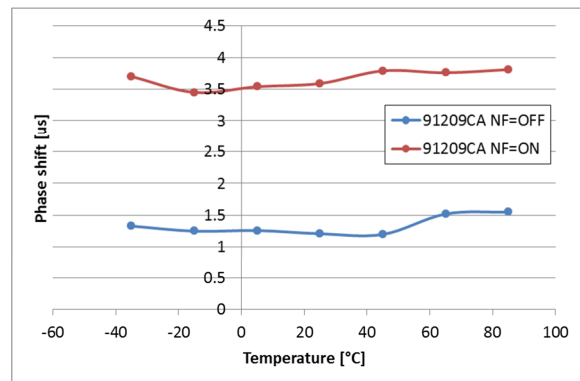

Figure 9: Phase shift over temperature.

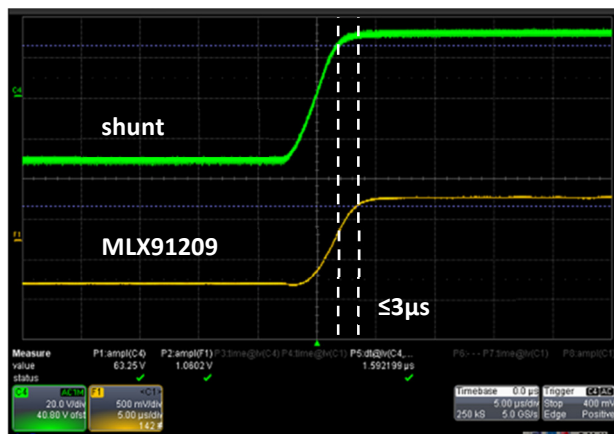

Figure 10: Response time with noise filter OFF.

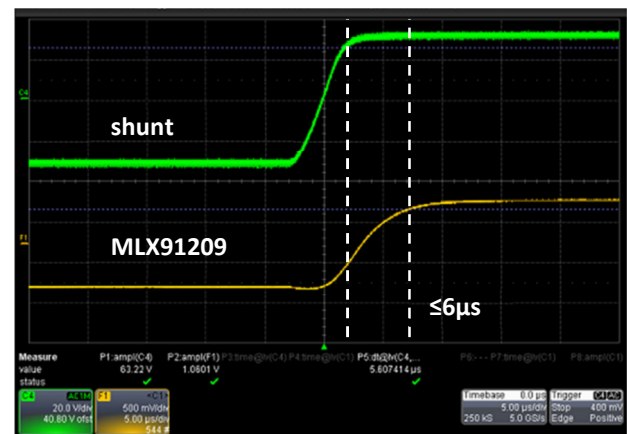

Figure 11: Response time with noise filter ON.

16. Standard information regarding manufacturability of Melexis products with different soldering processes

Our products are classified and qualified regarding soldering technology, solderability and moisture sensitivity level according to following test methods:

Reflow Soldering SMD's (Surface Mount Device)s)

- IPC/JEDEC J-STD-020
Moisture/Reflow Sensitivity Classification for Nonhermetic Solid State Surface Mount Devices (classification reflow profiles according to table 5-2)
- EIA/JEDEC JESD22-A113
Preconditioning of Nonhermetic Surface Mount Devices Prior to Reliability Testing (reflow profiles according to table 2)

Wave Soldering SMD's (Surface Mount Device)s) and THD's (Through Hole Device)s)

- EN60749-20
Resistance of plastic- encapsulated SMD's to combined effect of moisture and soldering heat
- EIA/JEDEC JESD22-B106 and EN60749-15
Resistance to soldering temperature for through-hole mounted devices

Iron Soldering THD's (Through Hole Device)s)

- EN60749-15
Resistance to soldering temperature for through-hole mounted devices

Solderability SMD's (Surface Mount Device)s) and THD's (Through Hole Device)s)

- EIA/JEDEC JESD22-B102 and EN60749-21
Solderability

For all soldering technologies deviating from above mentioned standard conditions (regarding peak temperature, temperature gradient, temperature profile, etc.) additional classification and qualification tests have to be agreed upon with Melexis.

The application of Wave Soldering for SMD's is allowed only after consulting Melexis regarding assurance of adhesive strength between device and board.

Melexis recommends reviewing on our web site the General Guidelines **soldering recommendation** (<https://www.melexis.com/en/tech-info/ic-handling-and-assembly/soldering>) as well as **trim&form recommendations** (<https://www.melexis.com/en/tech-info/ic-handling-and-assembly/lead-forming>).

Melexis is contributing to global environmental conservation by promoting **lead free** solutions. For more information on qualifications of **RoHS** compliant products (RoHS = European directive on the Restriction Of the use of certain Hazardous Substances) please visit the quality page on our website: <http://www.melexis.com/quality.aspx>

17. ESD Precautions

Electronic semiconductor products are sensitive to Electro Static Discharge (ESD). Always observe Electro Static Discharge control procedures whenever handling semiconductor products.

18. FAQ

For which current range can the sensor be used?

The magnetic field [mT] seen by the sensor for a given current [A] depends on the design of the enclosing ferromagnetic core (air gap size, material type, etc.). Therefore, the current range is not limited by the sensor itself, but rather by the magnetic properties of the core (saturation, hysteresis, etc.).

What is the default sensitivity of the sensor?

The sensor is factory calibrated for a typical sensitivity of 50mV/mT.

How can I program the sensor?

The sensor uses a 3 wires communication protocol (Vdd, GND and Out) and can be programmed using Melexis Universal Programmer (PTC-04), with the dedicated daughter board PTC04-DB-HALL05. For more information, please visit <http://www.melexis.com/Hardware-and-Software-Tools/Programming-Tools/PTC-04-568.aspx>.

19. Package Information

19.1. Package Marking & Hall Plate Position

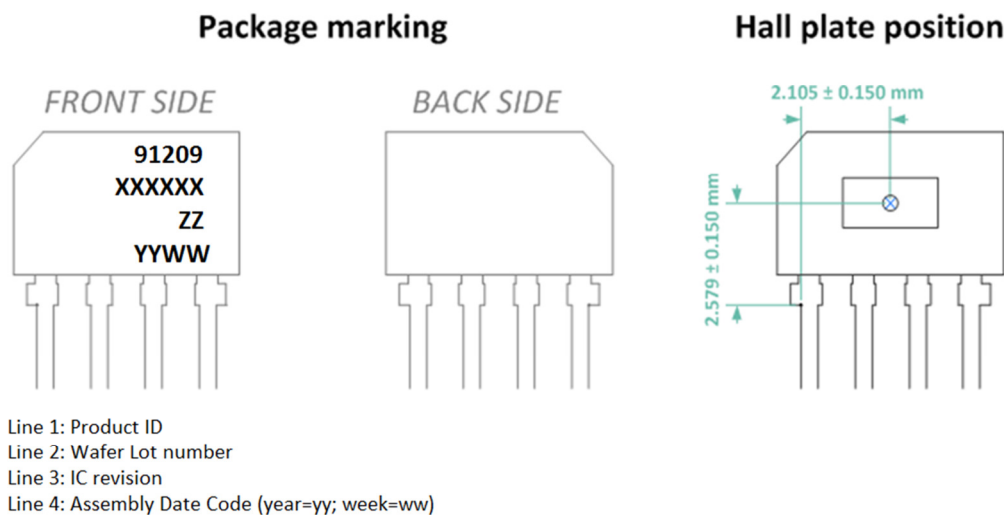
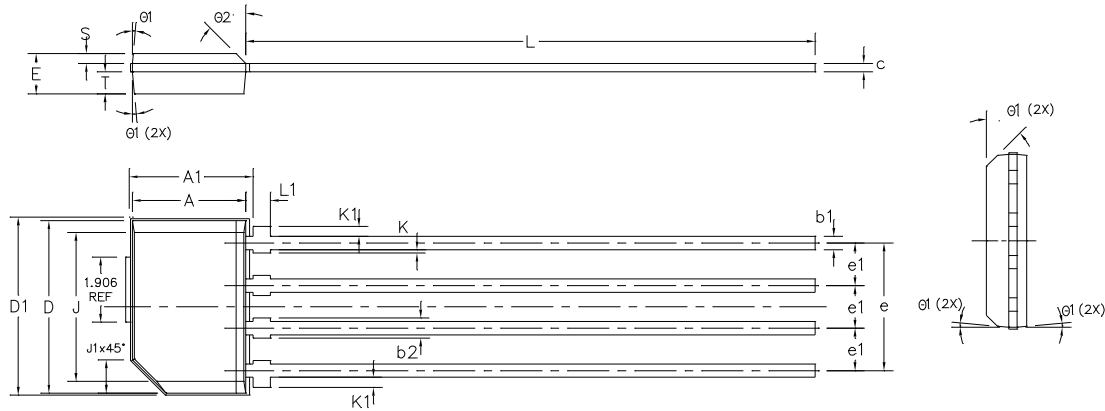

Figure 12: VA/SIP 4L Package Marking and Hall Plate Position

19.2. VA / SIP 4L (single in-line package)



SYMBOLS	DIMENSIONS IN MILLIMETERS		
	MIN	NOM	MAX
A	3.30	3.38	3.46
A1	3.63	3.71	3.79
D	5.08	5.16	5.24
D1	5.33	5.38	5.43
E	1.10	---	1.20
J	4.10	4.30	4.50
J1	1.00 REF		
K	0.00	---	0.15
K1	0.25	0.30	0.35
L	17.5	18.0	18.5
L1	0.48	0.53	0.58
S	0.24	---	0.29
T	0.61	---	0.66
b1	0.35	---	0.48
b2	0.40	---	0.60
c	0.18	---	0.34
e	3.76	---	3.86
e1	1.22	1.27	1.32
Ø1	5° REF		
Ø2	45° REF		

- Note:
1. DIMENSIONS "A" AND "D" DO NOT INCLUDE MOLD FLASH, PROTRUSIONS AND GATE BURRS.
 2. DIMENSIONS "A1" DOES NOT INCLUDE GATE BURRS BUT INCLUDES MOLD FLASH AT BOTH ENDS.
 3. MOLD GATE BURRS SHALL NOT EXCEED 0.15 mm MEASURED FROM EDGE OF MOLD FLASH (FLANGE).
 4. DIMENSION "D1" INCLUDES MOLD FLASH AT BOTH ENDS.
 5. LEAD PLATING; MATTE TIN PLATING THICKNESS 7.62 - 15.42 μ m.

19.3. Trim and form type: 90° 2x2x91.3 (h=5.34mm); Bending-STD2 (CAR-xxx)

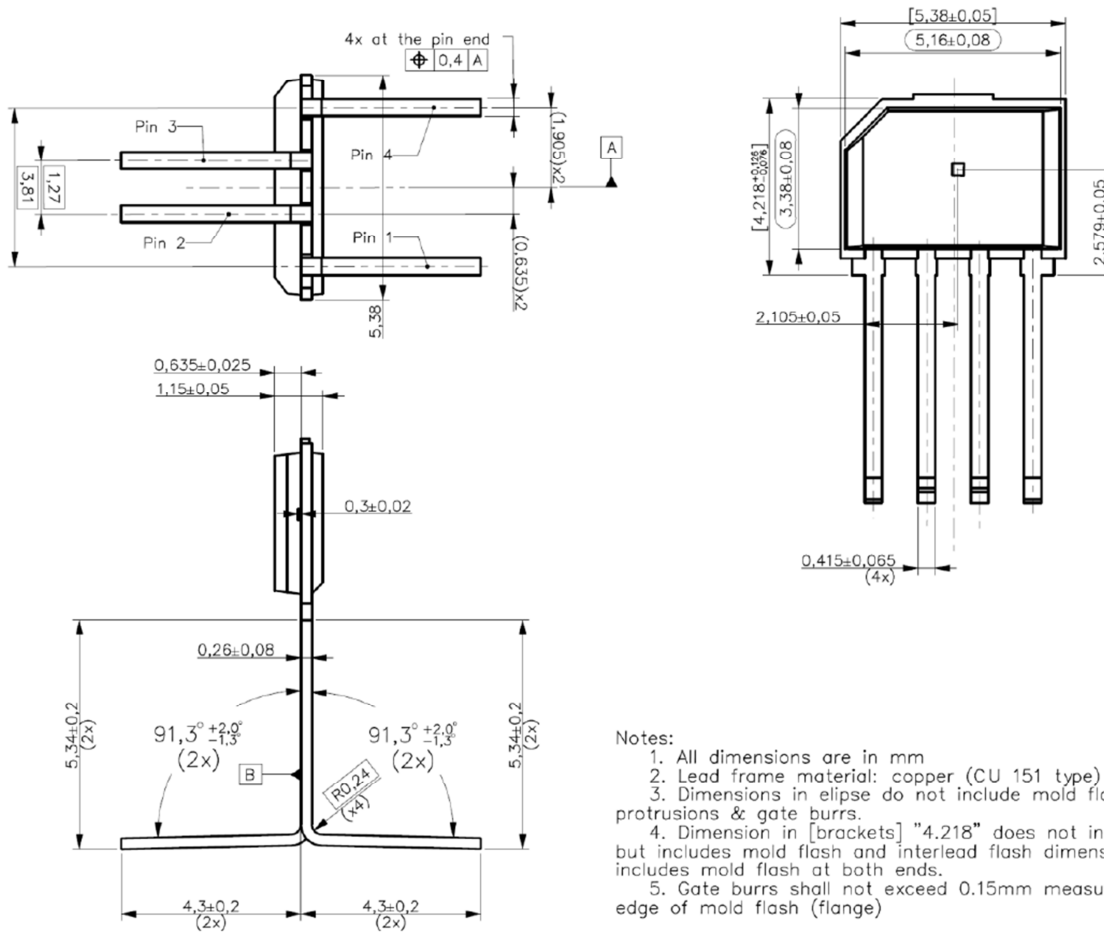

19.4. Trim and form type: SMD style TFT4K1 (CAZ-xxx)

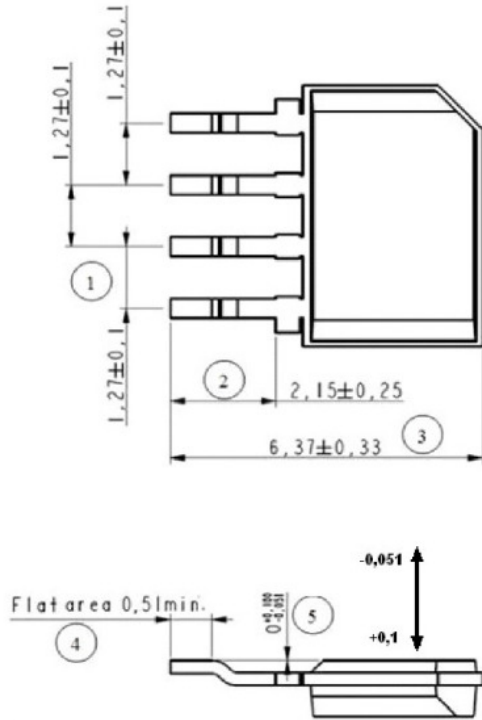

Parameter				
Dim# 1 [mm]	Dim# 2 [mm]	Dim# 3 [mm]	Dim# 4 [mm]	Dim# 5 [mm]
1.27 +/- 0.10	2.15 +/- 0.25	6.37 +/- 0.33	min. 0.51	0 -0.051/+0.10

20. Contact

For the latest version of this document, go to our website at www.melexis.com.

For additional information, please contact our Direct Sales team and get help for your specific needs:

Europe, Africa	Email : sales_europe@melexis.com
Americas	Email : sales_usa@melexis.com
Asia	Email : sales_asia@melexis.com

21. Disclaimer

The content of this document is believed to be correct and accurate. However, the content of this document is furnished "as is" for informational use only and no representation, nor warranty is provided by Melexis about its accuracy, nor about the results of its implementation. Melexis assumes no responsibility or liability for any errors or inaccuracies that may appear in this document. Customer will follow the practices contained in this document under its sole responsibility. This documentation is in fact provided without warranty, term, or condition of any kind, either implied or expressed, including but not limited to warranties of merchantability, satisfactory quality, non-infringement, and fitness for purpose. Melexis, its employees and agents and its affiliates' and their employees and agents will not be responsible for any loss, however arising, from the use of, or reliance on this document. Notwithstanding the foregoing, contractual obligations expressly undertaken in writing by Melexis prevail over this disclaimer.

This document is subject to change without notice, and should not be construed as a commitment by Melexis. Therefore, before placing orders or prior to designing the product into a system, users or any third party should obtain the latest version of the relevant information. Users or any third party must determine the suitability of the product described in this document for its application, including the level of reliability required and determine whether it is fit for a particular purpose.

This document as well as the product here described may be subject to export control regulations. Be aware that export might require a prior authorization from competent authorities. The product is not designed, authorized or warranted to be suitable in applications requiring extended temperature range and/or unusual environmental requirements. High reliability applications, such as medical life-support or life-sustaining equipment or avionics application are specifically excluded by Melexis. The product may not be used for the following applications subject to export control regulations: the development, production, processing, operation, maintenance, storage, recognition or proliferation of:

- 1. chemical, biological or nuclear weapons, or for the development, production, maintenance or storage of missiles for such weapons;*
- 2. civil firearms, including spare parts or ammunition for such arms;*
- 3. defense related products, or other material for military use or for law enforcement;*
- 4. any applications that, alone or in combination with other goods, substances or organisms could cause serious harm to persons or goods and that can be used as a means of violence in an armed conflict or any similar violent situation.*

No license nor any other right or interest is granted to any of Melexis' or third party's intellectual property rights.

If this document is marked "restricted" or with similar words, or if in any case the content of this document is to be reasonably understood as being confidential, the recipient of this document shall not communicate, nor disclose to any third party, any part of the document without Melexis' express written consent. The recipient shall take all necessary measures to apply and preserve the confidential character of the document. In particular, the recipient shall (i) hold document in confidence with at least the same degree of care by which it maintains the confidentiality of its own proprietary and confidential information, but no less than reasonable care; (ii) restrict the disclosure of the document solely to its employees, agents, professional advisors and contractors for the purpose for which this document was received, on a strictly need to know basis and providing that such persons to whom the document is disclosed are bound by confidentiality terms substantially similar to those in this disclaimer; (iii) use the document only in connection with the purpose for which this document was received, and reproduce document only to the extent necessary for such purposes; (iv) not use the document for commercial purposes or to the detriment of Melexis or its customers. The confidentiality obligations set forth in this disclaimer will have indefinite duration and in any case they will be effective for no less than 10 years from the receipt of this document.

This disclaimer will be governed by and construed in accordance with Belgian law and any disputes relating to this disclaimer will be subject to the exclusive jurisdiction of the courts of Brussels, Belgium.



The invalidity or ineffectiveness of any of the provisions of this disclaimer does not affect the validity or effectiveness of the other provisions. The previous versions of this document are repealed.

Melexis © - No part of this document may be reproduced without the prior written consent of Melexis. (2021)

IATF 16949 and ISO 14001 Certified

Looking for pricing, stock, or lifecycle information?

Click below to explore more details on WIN SOURCE:

-  [View MLX91209LVA-CAA-001-SP on WIN SOURCE](#)
-  [Melexis Technologies NV Information](#)

Optimize Your Supply Chain with WIN SOURCE Solutions

-  Global Sourcing Solution
-  Obsolete Management
-  Cost Control Management
-  Shortage Management
-  Alternative Solution
-  Excess Inventory Management