



**THE DATASHEET OF
RT9818A-28GV**



Micro-Power Voltage Detectors

General Description

The RT9818 is a micro-power voltage detector supervising the power supply voltage level for microprocessors (μ P) or digital systems. It provides internally fixed threshold levels with 0.1V per step ranging from 1.2V to 5V, which covers most digital applications. It features low supply current of 3 μ A. The RT9818 performs supervisory function by sending out a reset signal whenever the V_{DD} voltage falls below a preset threshold level. This reset signal will last the whole period before V_{DD} recovering. Once V_{DD} recovered upcrossing the threshold level, the reset signal will be released after a certain delay time. RT9818 is provided in SC-82, SC-70-3, SOT-23-3, SOT-23-5 and SOT-89 packages.

Ordering Information

RT9818□-□□□□	
□	Package Type
U3	: SC-70-3
V	: SOT-23-3
VL	: SOT-23-3 (L-Type)
B	: SOT-23-5
X	: SOT-89
Y	: SC-82
YR	: SC-82 (R-Type)
□	Lead Plating System
P	: Pb Free
G	: Green (Halogen Free and Pb Free)
□	Threshold Voltage
12	: 1.2V
13	: 1.3V
:	:
49	: 4.9V
50	: 5.0V
□	Reset Active Timeout Period
A	= 0ms ($\overline{\text{RESET}}$)
B	= 55ms ($\overline{\text{RESET}}$)
C	= 220ms ($\overline{\text{RESET}}$)
D	= 450ms ($\overline{\text{RESET}}$)
E	= 0ms (RESET)
F	= 55ms (RESET)
G	= 220ms (RESET)
H	= 450ms (RESET)

Note :

Richtek products are :

- ▶ RoHS compliant and compatible with the current requirements of IPC/JEDEC J-STD-020.
- ▶ Suitable for use in SnPb or Pb-free soldering processes.

Features

- Internally Fixed Threshold 1.2V to 5V in 0.1V Step
- High Accuracy $\pm 1.5\%$
- Low Supply Current 3 μ A
- No External Components Required
- Quick Reset within 20 μ s
- Built-In Recovery Delay Include 0ms, 55ms, 220ms, 450ms Options
- Low Functional Supply Voltage 0.9V
- N-Channel Open-Drain Output
- Small SC-82, SC-70-3, SOT-23-3, SOT-23-5, SOT-89 Packages
- RoHS Compliant and 100% Lead (Pb)-Free

Applications

- Computers
- Controllers
- Intelligent Instruments
- Critical μ P and μ C Power Monitoring
- Portable/Battery-Powered Equipment

Marking Information

For marking information, contact our sales representative directly or through a Richtek distributor located in your area.

Typical Application Circuit

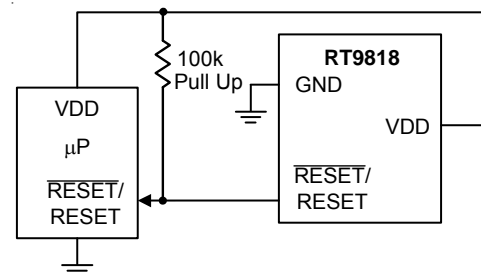

Pin Configuration

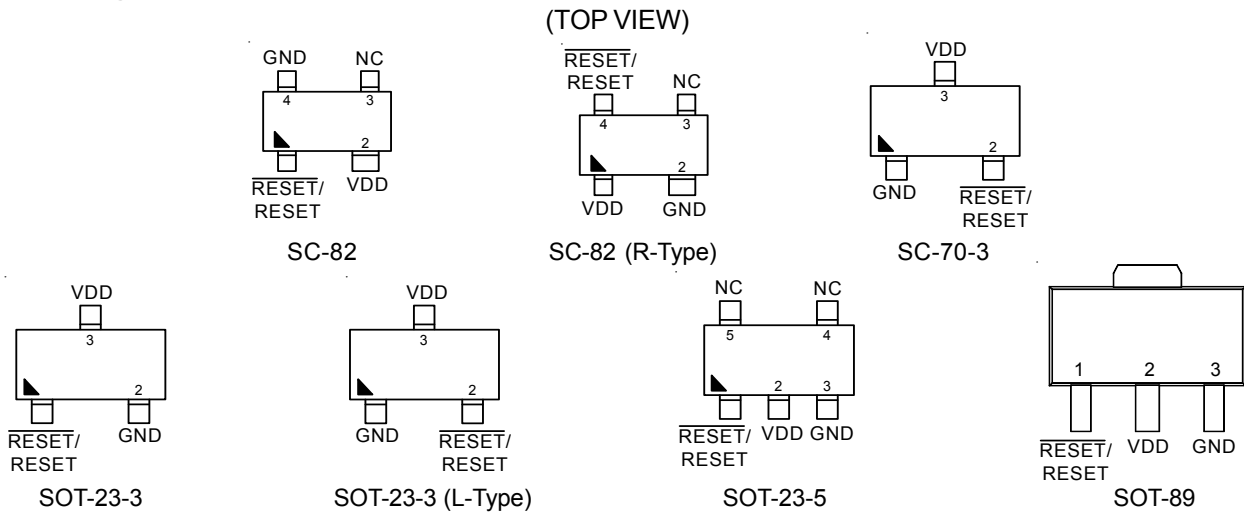

Functional Pin Description

Pin Name	Pin Function
GND	Ground.
RESET	Active low open-drain reset output.
RESET	Active high open-drain reset output.
VDD	Power pin.

Functional Block Diagram

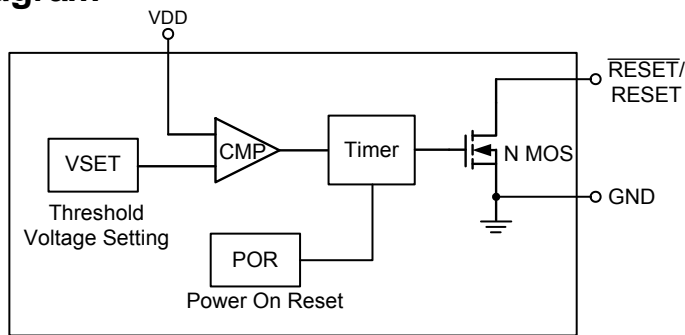

Timing Diagram

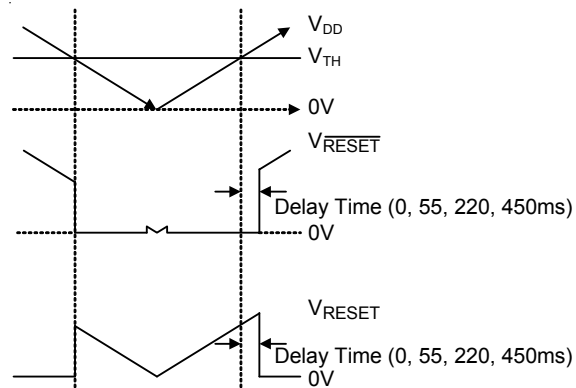

Absolute Maximum Ratings (Note 1)

- Terminal Voltage (with Respect to GND)
 - V_{DD} ----- -0.3V to 6V
- All Other Inputs ----- -0.3V to 6V
- Input Current, I_{VDD} ----- 20mA
- Power Dissipation, P_D @ $T_A = 25^\circ C$
 - SC-70 / SC-82 ----- 0.25W
 - SOT-23-3 ----- 0.4W
 - SOT-23-5 ----- 0.4W
 - SOT-89 ----- 0.55W
- Package Thermal Resistance (Note 2)
 - SC-70 / SC-82, θ_{JA} ----- 400°C/W
 - SOT-23-3, θ_{JA} ----- 250°C/W
 - SOT-23-5, θ_{JA} ----- 250°C/W
 - SOT-89, θ_{JA} ----- 180°C/W
- Lead Temperature (Soldering, 10sec.) ----- 260°C
- Storage Temperature Range ----- -65°C to 150°C
- ESD Susceptibility (Note 3)
 - HBM (Human Body Model) ----- 2kV

Recommended Operating Conditions (Note 4)

- Junction Temperature Range ----- -40°C to 125°C
- Ambient Temperature Range ----- -40°C to 85°C

Electrical Characteristics

($V_{DD} = 3V$, unless otherwise specified)

Parameter	Symbol	Test Conditions	Min	Typ	Max	Unit	
Operating V_{DD} (V_{OUT}) Range	V_{DD}		0.9	–	6	V	
Supply Current	I_{DD}	$V_{TH} = 3V, V_{DD} = 4.5V, T_A = 27^\circ C$	--	3	8	μA	
Reset Threshold	V_{TH}	$T_A = 27^\circ C$	--	1.2 to 5	--	V	
Threshold Voltage Accuracy	ΔV_{TH}	$T_A = 27^\circ C$	-1.5	–	1.5	%	
V_{DD} Drop to Reset Delay	t_{RD}	Drop = $V_{TH} - 125mV$	--	20	--	μs	
Reset Active Time Out Period	RT9818A/E	t_{RP}	$V_{DD} \geq 1.02 \times V_{TH}$	--	0	--	ms
	RT9818B/F			35	55	75	
	RT9818C/G			143	220	297	
	RT9818D/H			292	450	608	
RESET Output Voltage Low (Note 5)	V_{OL}	$3 = V_{DD} < V_{TH} I_{SINK} > 3.5mA$	--	–	0.4	V	
Hysteresis Width	V_{HYS}		--	$0.01V_{TH}$	$0.016V_{TH}$	V	

- Note 1.** Stresses beyond those listed “Absolute Maximum Ratings” may cause permanent damage to the device. These are stress ratings only, and functional operation of the device at these or any other conditions beyond those indicated in the operational sections of the specifications is not implied. Exposure to absolute maximum rating conditions may affect device reliability.
- Note 2.** θ_{JA} is measured at $T_A = 25^\circ\text{C}$ on a low effective thermal conductivity single-layer test board per JEDEC 51-3.
- Note 3.** Devices are ESD sensitive. Handling precaution is recommended.
- Note 4.** The device is not guaranteed to function outside its operating conditions.
- Note 5.** The voltage V_{OL} can be calculated by $V_{OL} = V_{DD} - I_r * R$. Where R is the pull-up resistor and I_r is the current flowing through the pull-up resistor. For typical application ($R=100\text{k}\Omega$), V_{OL} is less than 0.2V.

Typical Operating Characteristics

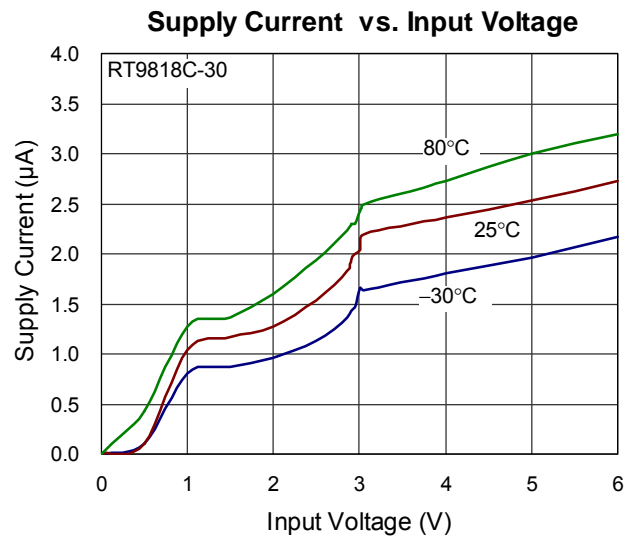
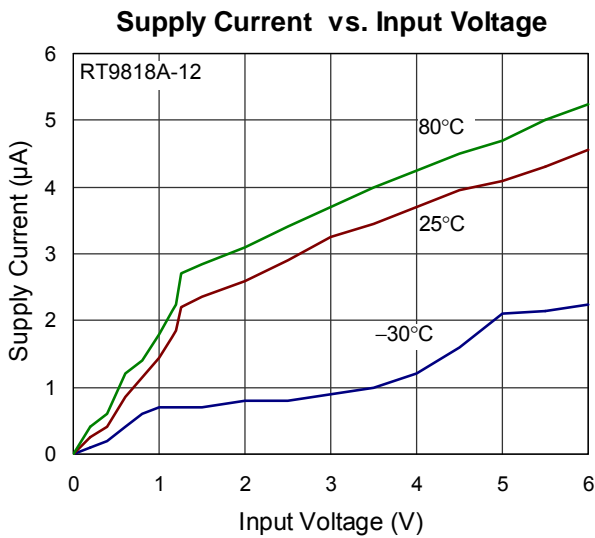
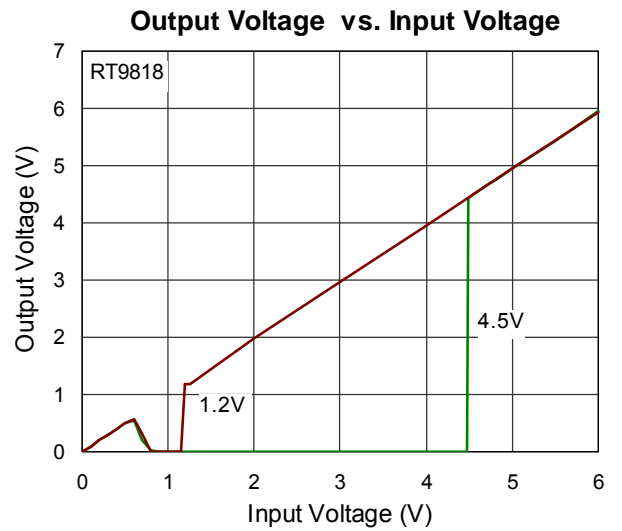
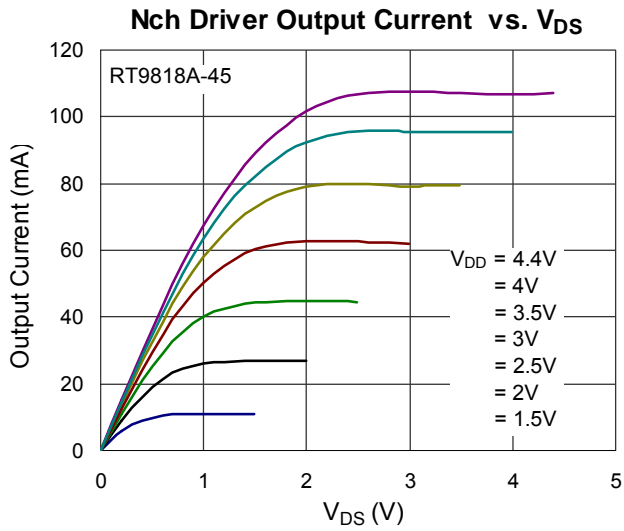
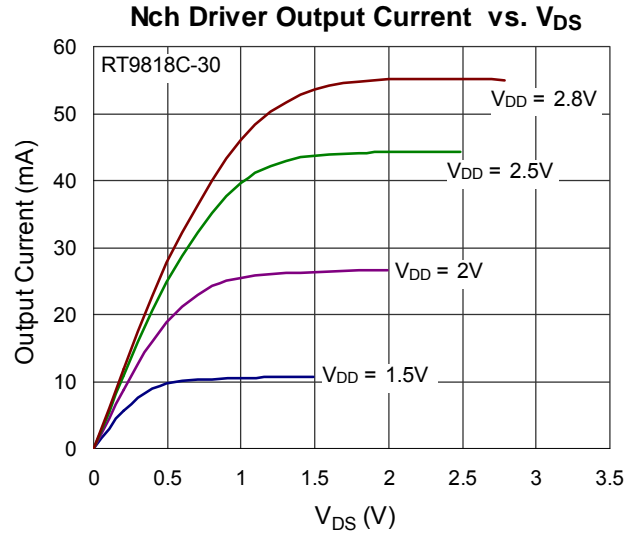
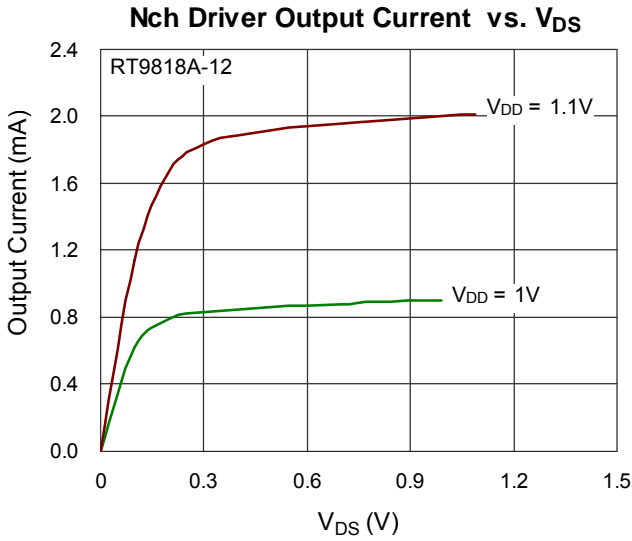

Supply Current vs. Input Voltage

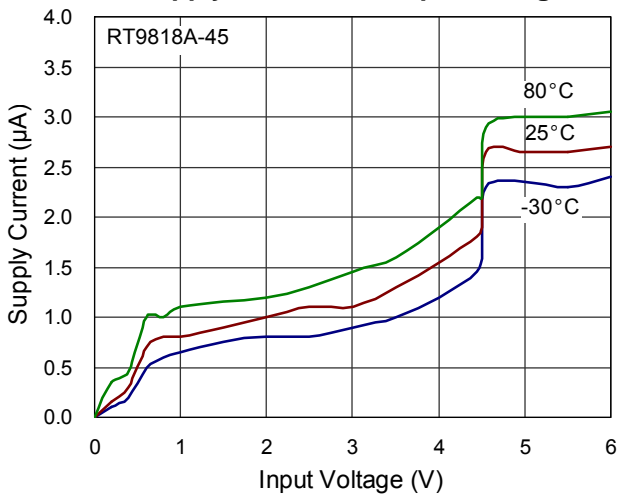

Power Down Reset Delay vs. Temperature

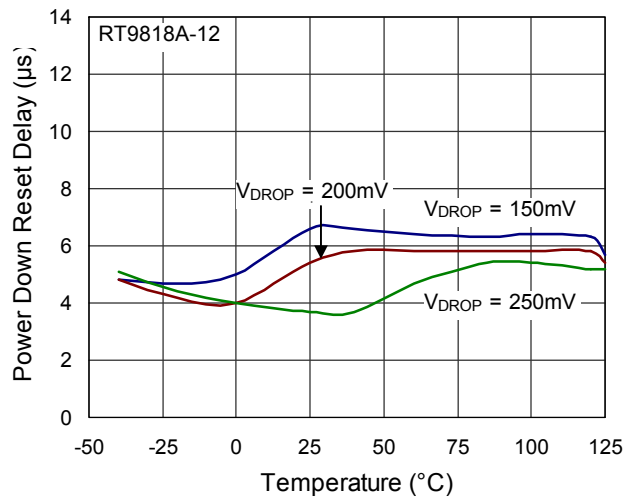

Power Down Reset Delay vs. Temperature

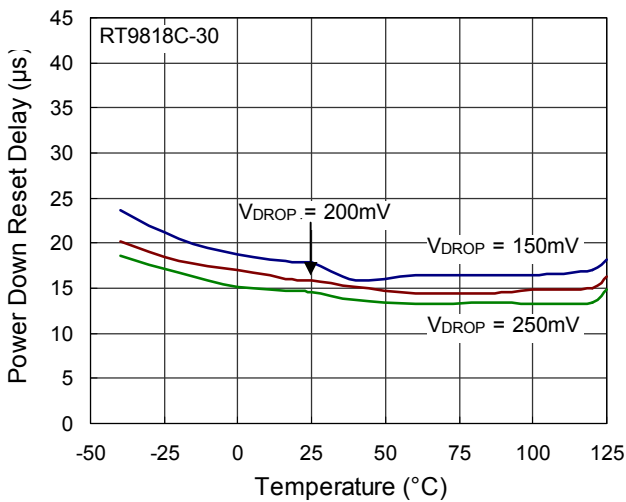

Power Down Reset Delay vs. Temperature

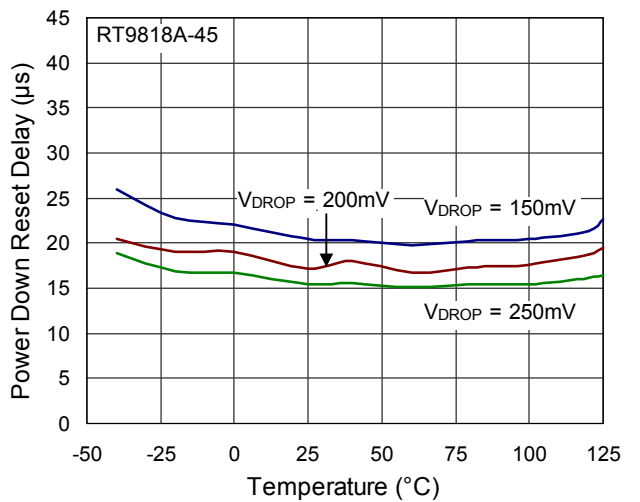

Reset Threshold Deviation vs. Temperature

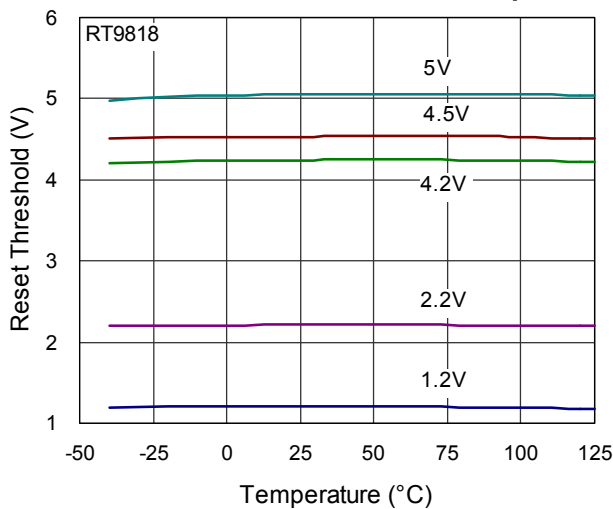

Load Driver Sink Current vs. Input Voltage

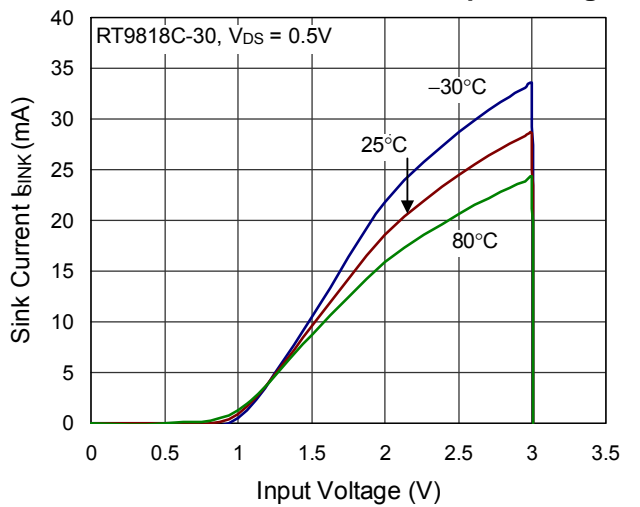

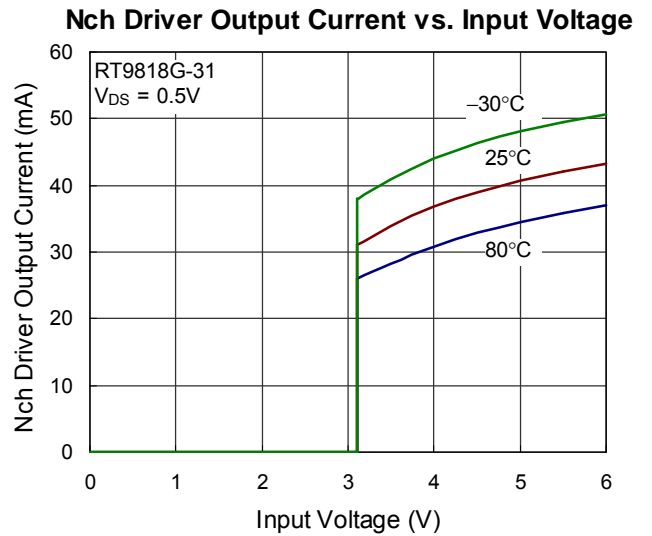
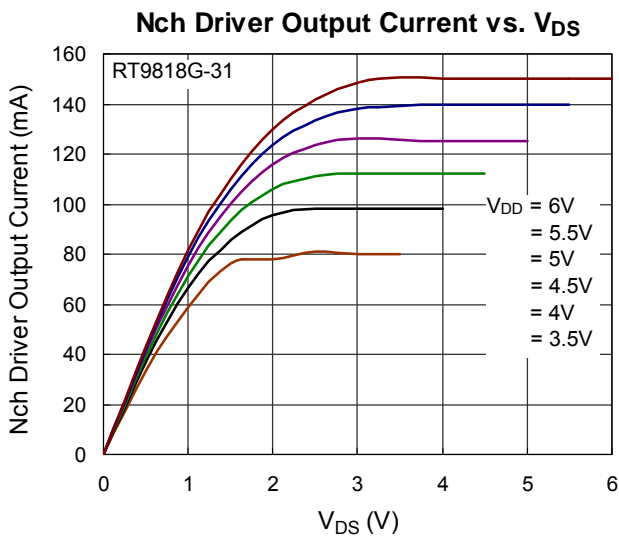
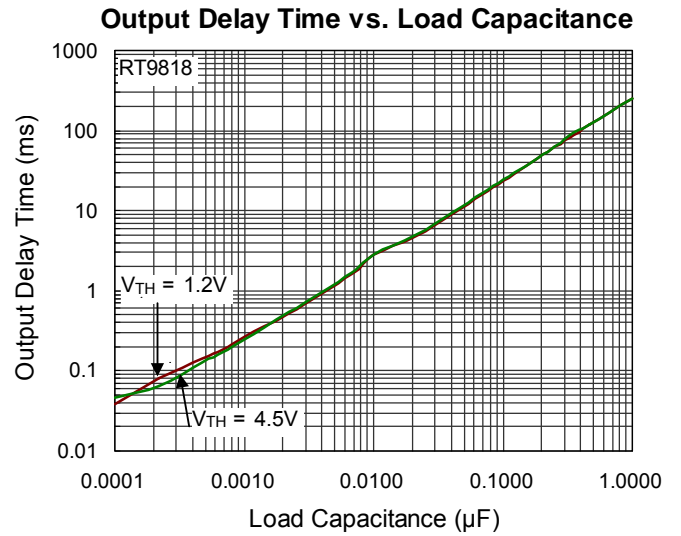
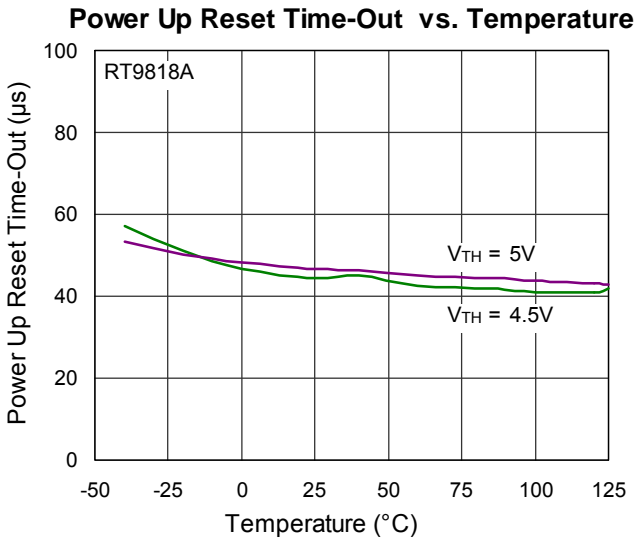
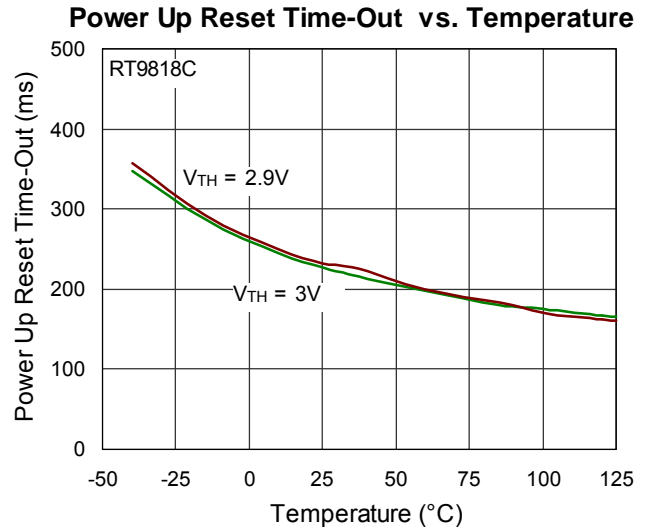
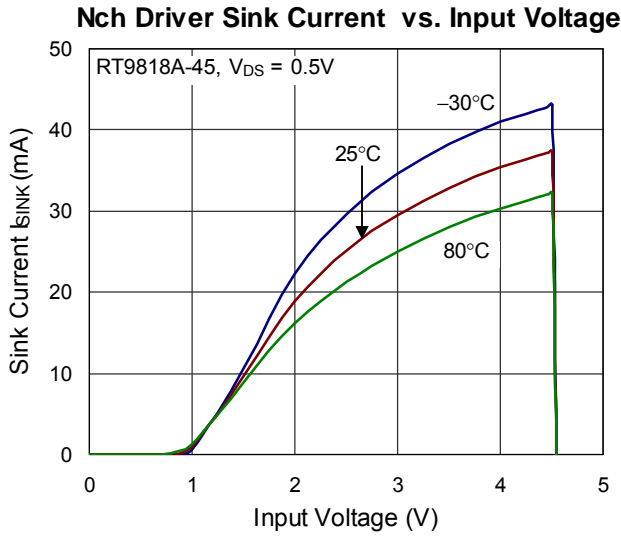

Power Down Reset Time-Out vs. Temperature

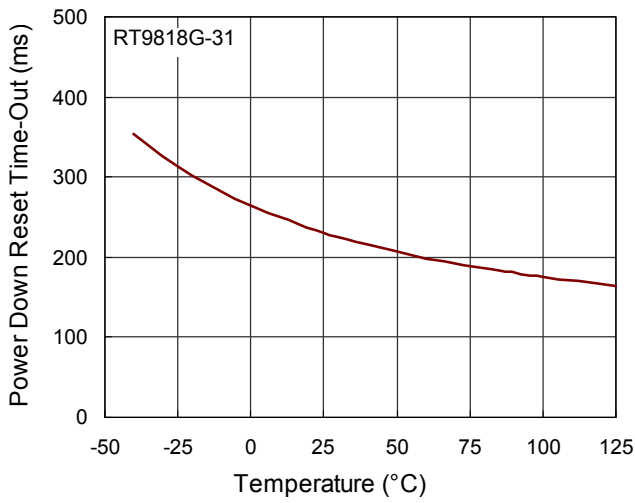

Output Voltage vs. Input Voltage

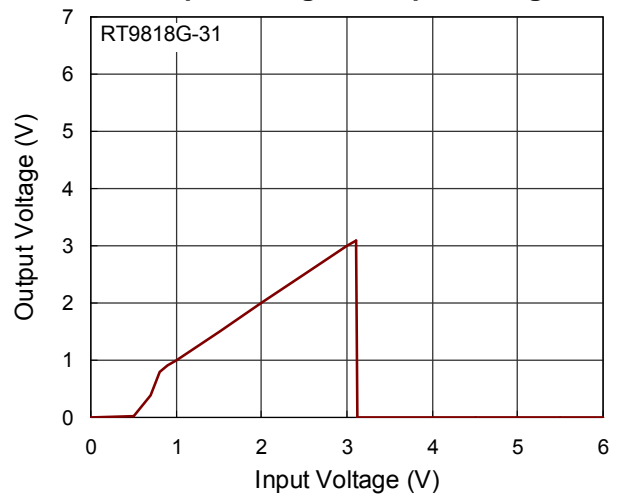

Power Down Reset Time-Out vs. Temperature

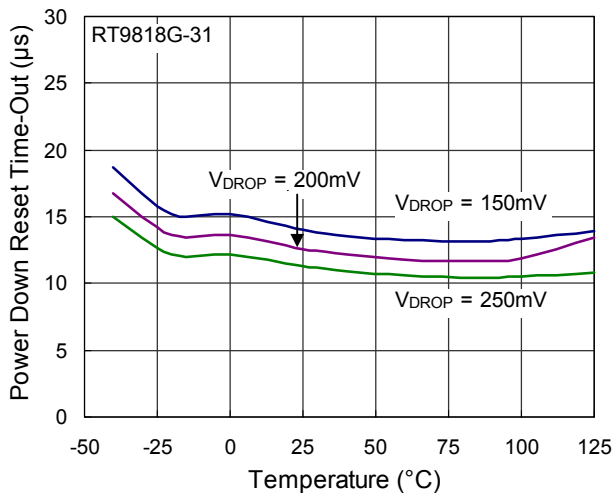

Threshold Voltage vs. Temperature

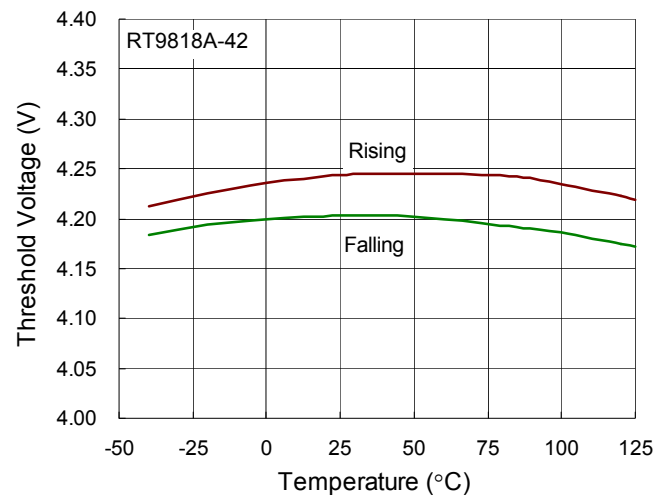

Threshold Voltage vs. Temperature

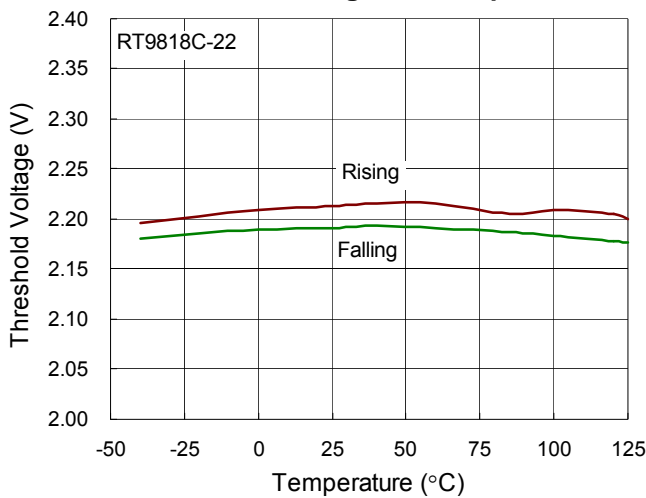

Application Information

Multiple Supplies

Mainly, the pull-up connected to the RT9818 will connect to the supply voltage that is being monitored at the IC's VDD pin. However, some systems may use the open-drain output to level-shift from the monitored supply to reset circuitry powered by some other supply.

Benefits of Highly Accurate Reset Threshold

Most μ P supervisor ICs have reset threshold voltages between 1% and 1.5% below the value of nominal supply voltages. This ensures a reset will not occur within 1% of the nominal supply, but will occur when the supply is 1.5% below nominal.

Outline Dimension

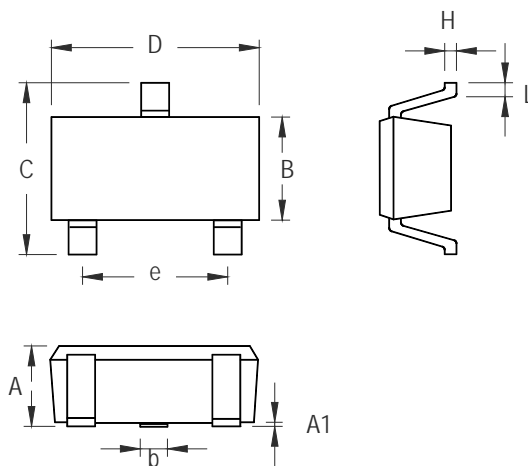

Symbol	Dimensions In Millimeters		Dimensions In Inches	
	Min	Max	Min	Max
A	0.800	1.100	0.031	0.044
A1	0.000	0.100	0.000	0.004
B	1.150	1.350	0.045	0.054
b	0.150	0.400	0.006	0.016
C	1.800	2.450	0.071	0.096
D	1.800	2.250	0.071	0.089
e	1.300		0.051	
H	0.080	0.260	0.003	0.010
L	0.210	0.460	0.008	0.018

SC-70-3 Surface Mount Package

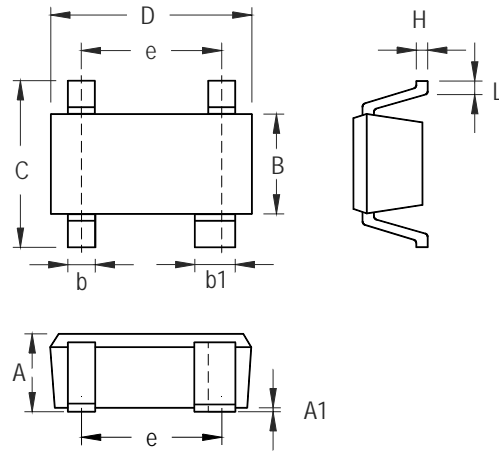

Symbol	Dimensions In Millimeters		Dimensions In Inches	
	Min	Max	Min	Max
A	0.800	1.100	0.031	0.043
A1	0.000	0.100	0.000	0.004
B	1.150	1.350	0.045	0.053
b	0.150	0.400	0.006	0.016
b1	0.350	0.500	0.014	0.020
C	1.800	2.450	0.071	0.096
D	1.800	2.200	0.071	0.087
e	1.300		0.051	
H	0.080	0.260	0.003	0.010
L	0.200	0.460	0.008	0.018

SC-82 Surface Mount Package

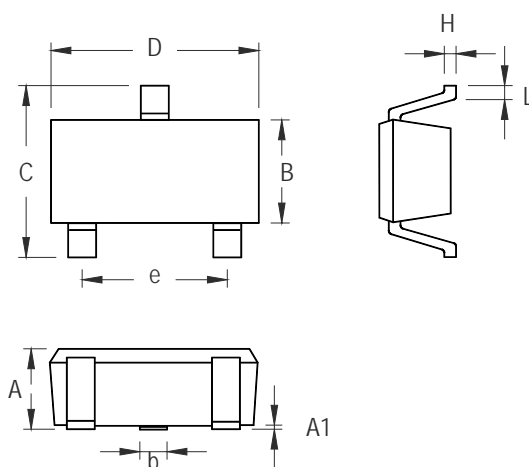

Symbol	Dimensions In Millimeters		Dimensions In Inches	
	Min	Max	Min	Max
A	0.889	1.295	0.035	0.051
A1	0.000	0.152	0.000	0.006
B	1.397	1.803	0.055	0.071
b	0.356	0.508	0.014	0.020
C	2.591	2.997	0.102	0.118
D	2.692	3.099	0.106	0.122
e	1.803	2.007	0.071	0.079
H	0.080	0.254	0.003	0.010
L	0.300	0.610	0.012	0.024

SOT-23-3 Surface Mount Package

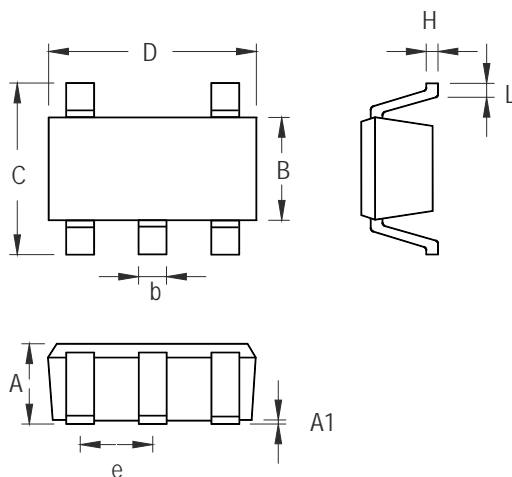

Symbol	Dimensions In Millimeters		Dimensions In Inches	
	Min	Max	Min	Max
A	0.889	1.295	0.035	0.051
A1	0.000	0.152	0.000	0.006
B	1.397	1.803	0.055	0.071
b	0.356	0.559	0.014	0.022
C	2.591	2.997	0.102	0.118
D	2.692	3.099	0.106	0.122
e	0.838	1.041	0.033	0.041
H	0.080	0.254	0.003	0.010
L	0.300	0.610	0.012	0.024

SOT-23-5 Surface Mount Package

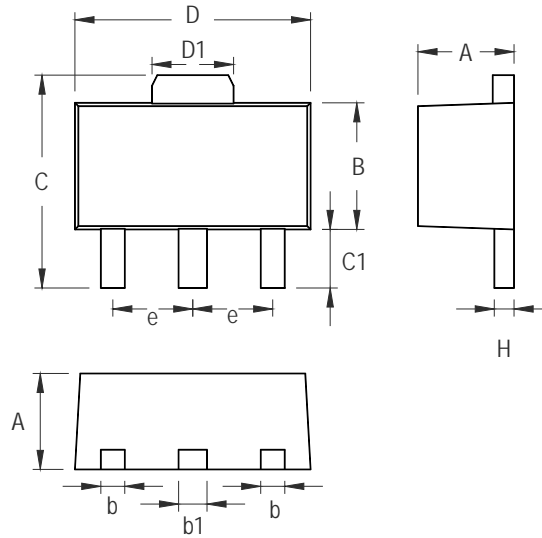

Symbol	Dimensions In Millimeters		Dimensions In Inches	
	Min	Max	Min	Max
A	1.397	1.600	0.055	0.063
b	0.356	0.483	0.014	0.019
B	2.388	2.591	0.094	0.102
b1	0.406	0.533	0.016	0.021
C	3.937	4.242	0.155	0.167
C1	0.787	1.194	0.031	0.047
D	4.394	4.597	0.173	0.181
D1	1.397	1.753	0.055	0.069
e	1.448	1.549	0.057	0.061
H	0.356	0.432	0.014	0.017

3-Lead SOT-89 Surface Mount Package



Richtek Technology Corporation

14F, No. 8, Tai Yuen 1st Street, Chupei City
 Hsinchu, Taiwan, R.O.C.
 Tel: (8863)5526789

Richtek products are sold by description only. Richtek reserves the right to change the circuitry and/or specifications without notice at any time. Customers should obtain the latest relevant information and data sheets before placing orders and should verify that such information is current and complete. Richtek cannot assume responsibility for use of any circuitry other than circuitry entirely embodied in a Richtek product. Information furnished by Richtek is believed to be accurate and reliable. However, no responsibility is assumed by Richtek or its subsidiaries for its use; nor for any infringements of patents or other rights of third parties which may result from its use. No license is granted by implication or otherwise under any patent or patent rights of Richtek or its subsidiaries.

Looking for pricing, stock, or lifecycle information?

Click below to explore more details on WIN SOURCE:

-  [View RT9818A-28GV on WIN SOURCE](#)
-  [Richtek USA Inc. Information](#)

Optimize Your Supply Chain with WIN SOURCE Solutions

-  Global Sourcing Solution
-  Obsolete Management
-  Cost Control Management
-  Shortage Management
-  Alternative Solution
-  Excess Inventory Management