



# THE DATASHEET OF BYT60P-400





# BYT60P-400 BYT260PIV-400 / BYT261PIV-400

## FAST RECOVERY RECTIFIER DIODES

### MAIN PRODUCT CHARACTERISTICS

$I_{F(AV)}$	2 x 60 A
$V_{RRM}$	400 V
$V_F(\max)$	1.4 V
$t_{rr}(\max)$	50 ns

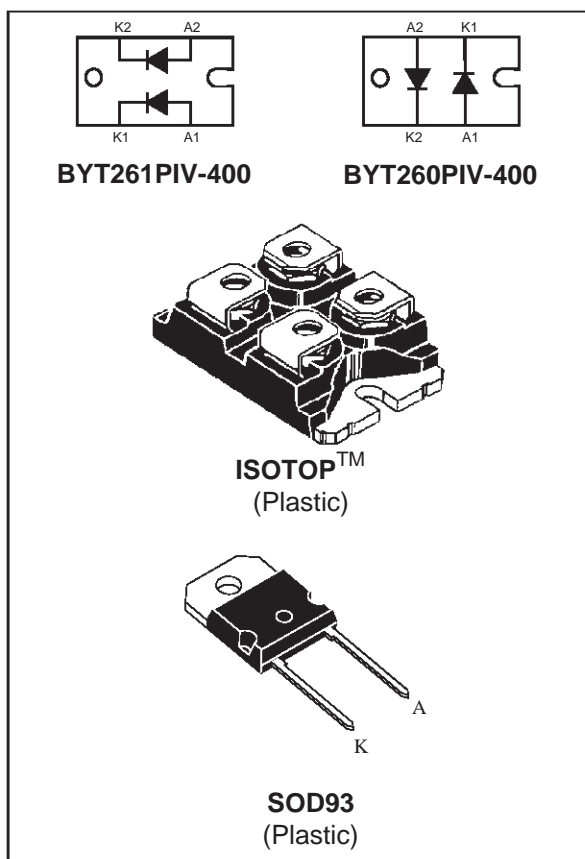
### FEATURES AND BENEFITS

- VERY LOW REVERSE RECOVERY TIME
- VERY LOW SWITCHING LOSSES
- LOW NOISE TURN-OFF SWITCHING
- INSULATED PACKAGE: ISOTOP  
Insulation voltage: 2500  $V_{RMS}$   
Capacitance = 45 pF  
Inductance < 5 nH

### DESCRIPTION

These rectifier devices are suited for free-wheeling function in converters and motor control circuits.

Packaged in ISOTOP or SOD93, they are intended for use in Switch Mode Power Supplies.



### ABSOLUTE RATINGS (limiting values, per diode)

Symbol	Parameter		Value	Unit
$V_{RRM}$	Repetitive peak reverse voltage		400	V
$I_{FRM}$	Repetitive peak forward current	$t_p=5 \mu s$ $F=1kHz$	1000	A
$I_{F(RMS)}$	RMS forward current	ISOTOP	140	A
		SOD93	100	
$I_{F(AV)}$	Average forward current $\delta = 0.5$	$T_c = 70^\circ C$ ISOTOP	60	A
		$T_c = 80^\circ C$ SOD93		
$I_{FSM}$	Surge non repetitive forward current $t_p = 10 ms$ Sinusoidal	ISOTOP	600	A
		SOD93	550	
$T_{stg}$	Storage temperature range		- 40 to + 150	$^\circ C$
$T_j$	Maximum operating junction temperature		150	$^\circ C$

TM: ISOTOP is a registered trademark of STMicroelectronics.

## BYT60P-400 / BYT260PIV-400 / BYT261PIV-400

### THERMAL RESISTANCES

Symbol	Parameter		Value	Unit	
$R_{th(j-c)}$	Junction to case	ISOTOP	Per diode	0.8	°C/W
			Total	0.45	
		SOD93	Total	0.7	
$R_{th(c)}$			Coupling	0.1	°C/W

When the diodes 1 and 2 are used simultaneously :

$$\Delta T_j(\text{diode } 1) = P(\text{diode } 1) \times R_{th(j-c)} (\text{Per diode}) + P(\text{diode } 2) \times R_{th(c)}$$

### STATIC ELECTRICAL CHARACTERISTICS (per diode)

Symbol	Parameter	Test Conditions		Min.	Typ.	Max.	Unit
$V_F^*$	Forward voltage drop	$T_j = 25^\circ\text{C}$	$I_F = 60\text{ A}$			1.5	V
		$T_j = 100^\circ\text{C}$				1.4	
$I_R^{**}$	Reverse leakage current	$T_j = 25^\circ\text{C}$	$V_R = V_{RRM}$			60	$\mu\text{A}$
		$T_j = 100^\circ\text{C}$				6	mA

Pulse test : \*  $t_p = 380\ \mu\text{s}$ ,  $\delta < 2\%$

\*\*  $t_p = 5\ \text{ms}$ ,  $\delta < 2\%$

To evaluate the conduction losses use the following equation:

$$P = 1.1 \times I_{F(AV)} + 0.0045 I_F^2(\text{RMS})$$

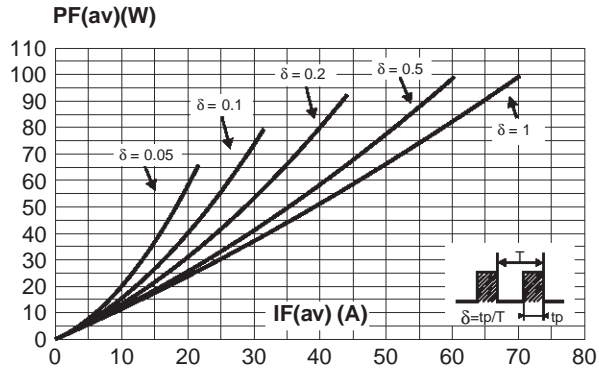
### RECOVERY CHARACTERISTICS (per diode)

Symbol	Test Conditions		Min.	Typ.	Max.	Unit
$t_{rr}$	$T_j = 25^\circ\text{C}$	$I_F = 1\text{ A}$ $V_R = 30\text{ V}$ $di_F/dt = -15\text{ A}/\mu\text{s}$			100	ns
		$I_F = 0.5\text{ A}$ $I_R = 1\text{ A}$ $I_{rr} = 0.25\text{ A}$			50	

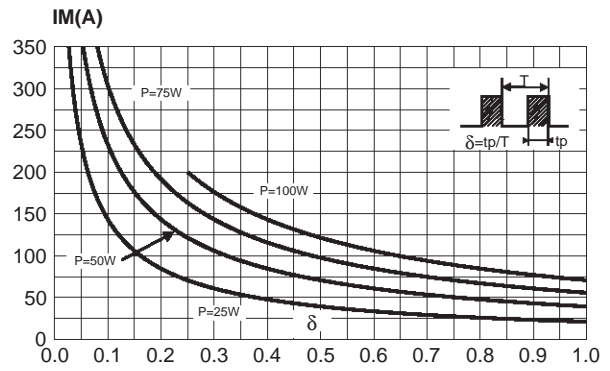
### TURN-OFF SWITCHING CHARACTERISTICS

Symbol	Parameter	Test Conditions		Min.	Typ.	Max.	Unit
$t_{IRM}$	Maximum reverse recovery time	$di_F/dt = -240\ \text{A}/\mu\text{s}$	$V_{CC} = 200\text{ V}$ $I_F = 60\text{ A}$ $L_p \text{ @ } 0.05\ \mu\text{H}$ $T_j = 100^\circ\text{C}$ (see fig. 13)			75	ns
		$di_F/dt = -480\ \text{A}/\mu\text{s}$				50	
$I_{RM}$	Maximum reverse recovery current	$di_F/dt = -240\ \text{A}/\mu\text{s}$	$V_{CC} = 200\text{ V}$ $I_F = 60\text{ A}$ $L_p \text{ @ } 0.05\ \mu\text{H}$ $T_j = 100^\circ\text{C}$ (see fig. 13)			18	A
		$di_F/dt = -480\ \text{A}/\mu\text{s}$				24	
$C = \frac{V_{RP}}{V_{CC}}$	Turn-off overvoltage coefficient	$T_j = 100^\circ\text{C}$ $V_{CC} = 120\text{ V}$ $I_F = I_{F(AV)}$ $di_F/dt = -60\text{ A}/\mu\text{s}$ $L_p = 0.8\ \mu\text{H}$ (see fig. 14)			3.3	4	/

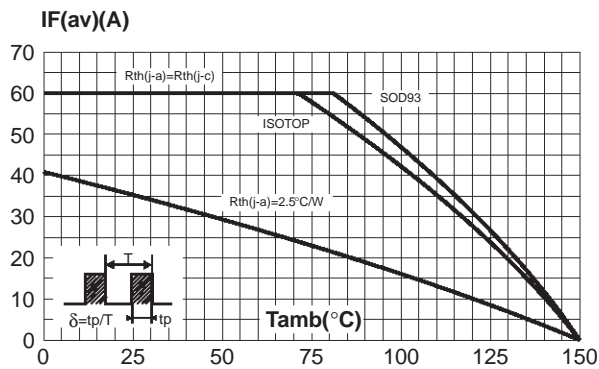
**Fig. 1:** Average forward power dissipation versus average forward current (per diode, for ISOTOP).



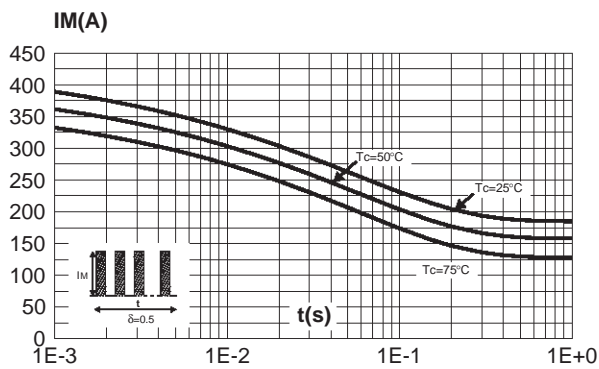
**Fig. 2:** Peak current versus form factor (per diode, for ISOTOP).



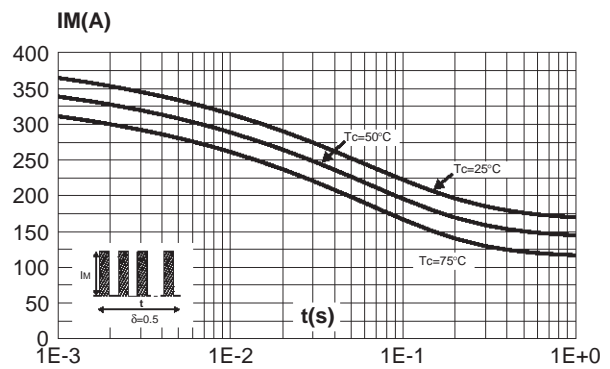
**Fig. 3:** Average forward current versus ambient temperature ( $\delta=0.5$ , per diode for ISOTOP).



**Fig. 4-1:** Non repetitive surge peak forward current versus overload duration (SOD93).

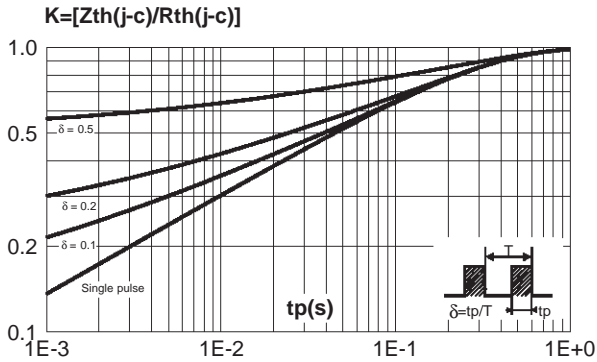


**Fig. 4-2:** Non repetitive surge peak forward current versus overload duration (per diode, for ISOTOP).

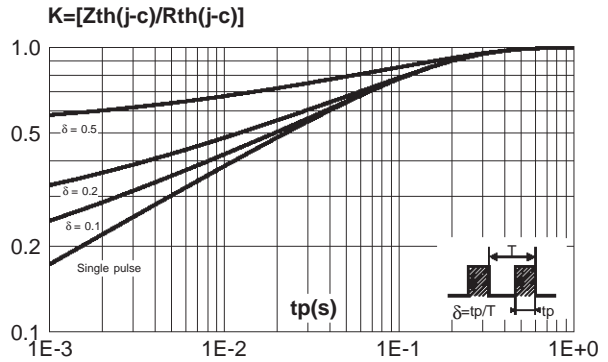


**BYT60P-400 / BYT260PIV-400 / BYT261PIV-400**

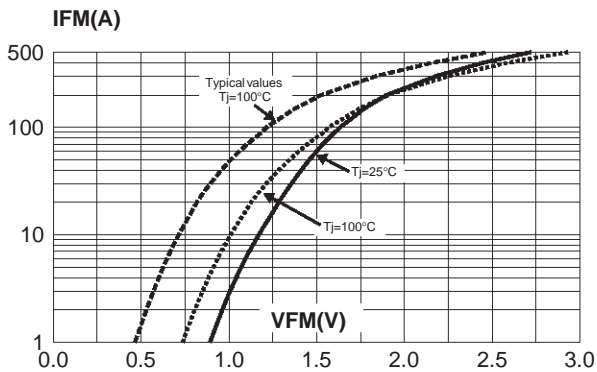
**Fig. 5-1:** Relative variation of thermal impedance junction to case versus pulse duration (per diode for ISOTOP).



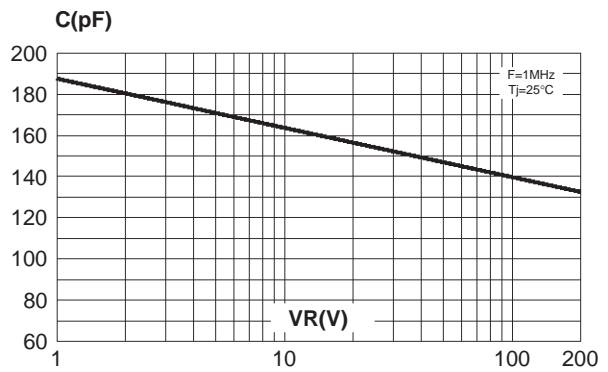
**Fig. 5-2:** Relative variation of thermal impedance junction to case versus pulse duration (SOD93).



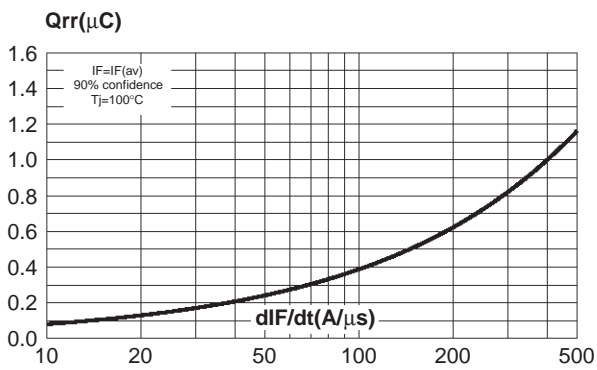
**Fig. 6:** Forward voltage drop versus forward current (maximum values, per diode for ISOTOP).



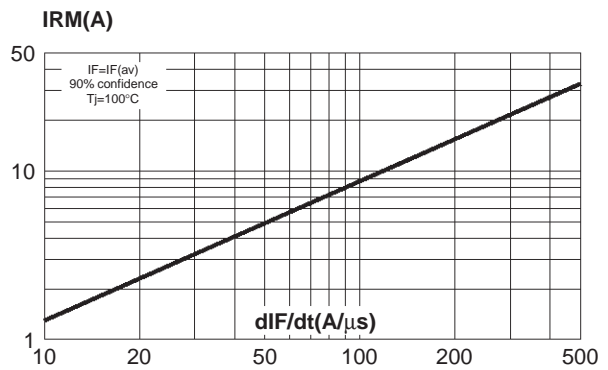
**Fig. 7:** Junction capacitance versus reverse voltage applied (typical values, per diode for ISOTOP).



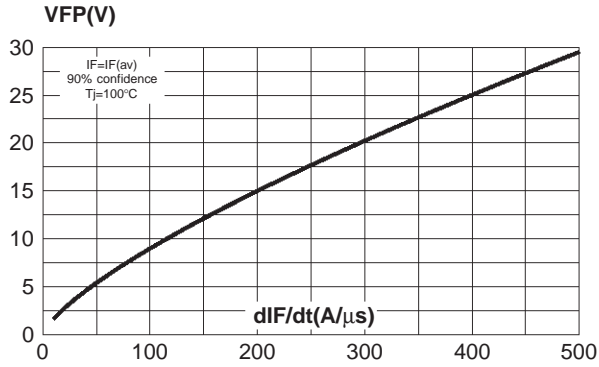
**Fig. 8:** Recovery charges versus  $dI_F/dt$  (per diode for ISOTOP).



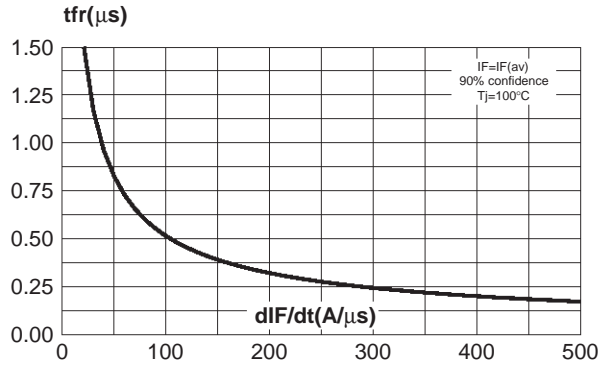
**Fig. 9:** Recovery current versus  $dI_F/dt$  (per diode for ISOTOP).



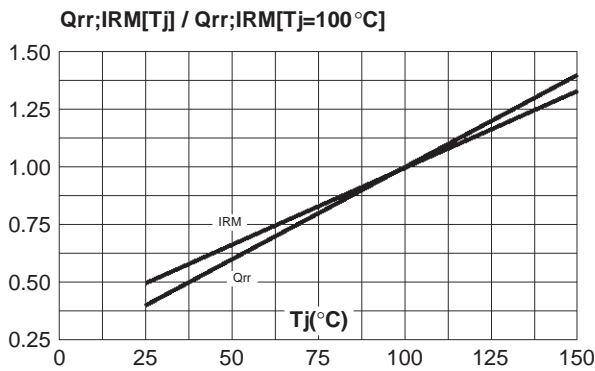
**Fig. 10:** Transient peak forward voltage versus  $di_F/dt$  (per diode for ISOTOP).



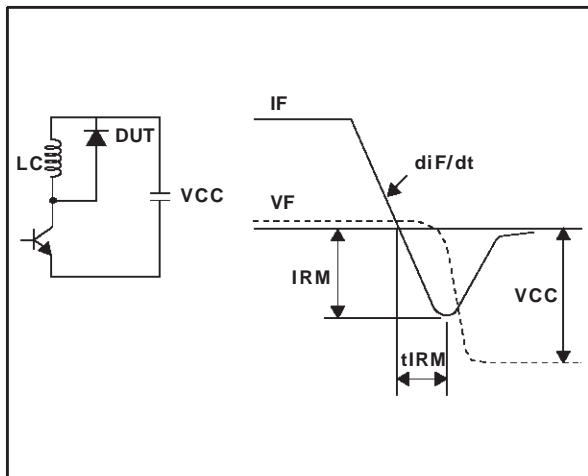
**Fig. 11:** Forward recovery time versus  $di_F/dt$  (per diode for ISOTOP).



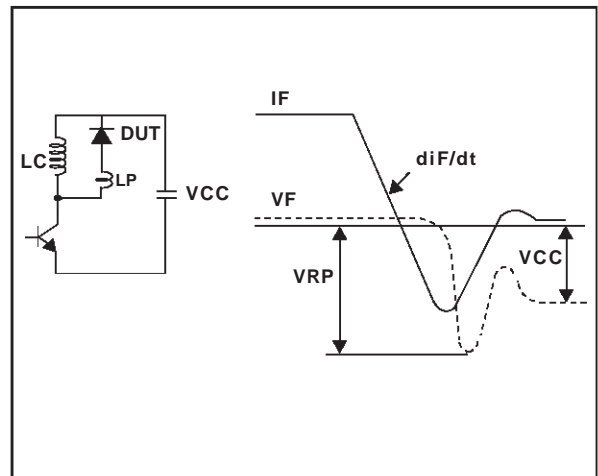
**Fig. 12:** Dynamic parameters versus junction temperature.



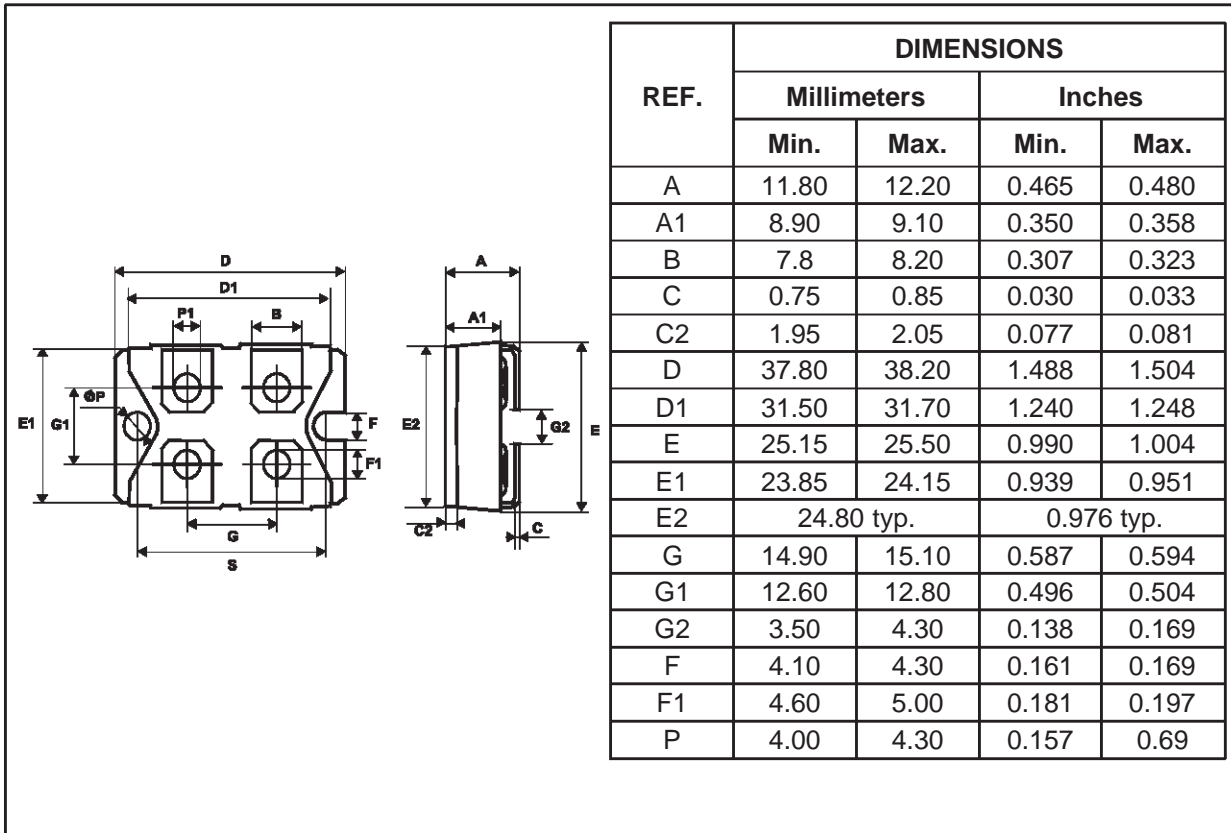
**Fig. 13:** Turn-off switching characteristics (without serie inductance).



**Fig. 14:** Turn-off switching characteristics (with serie inductance).



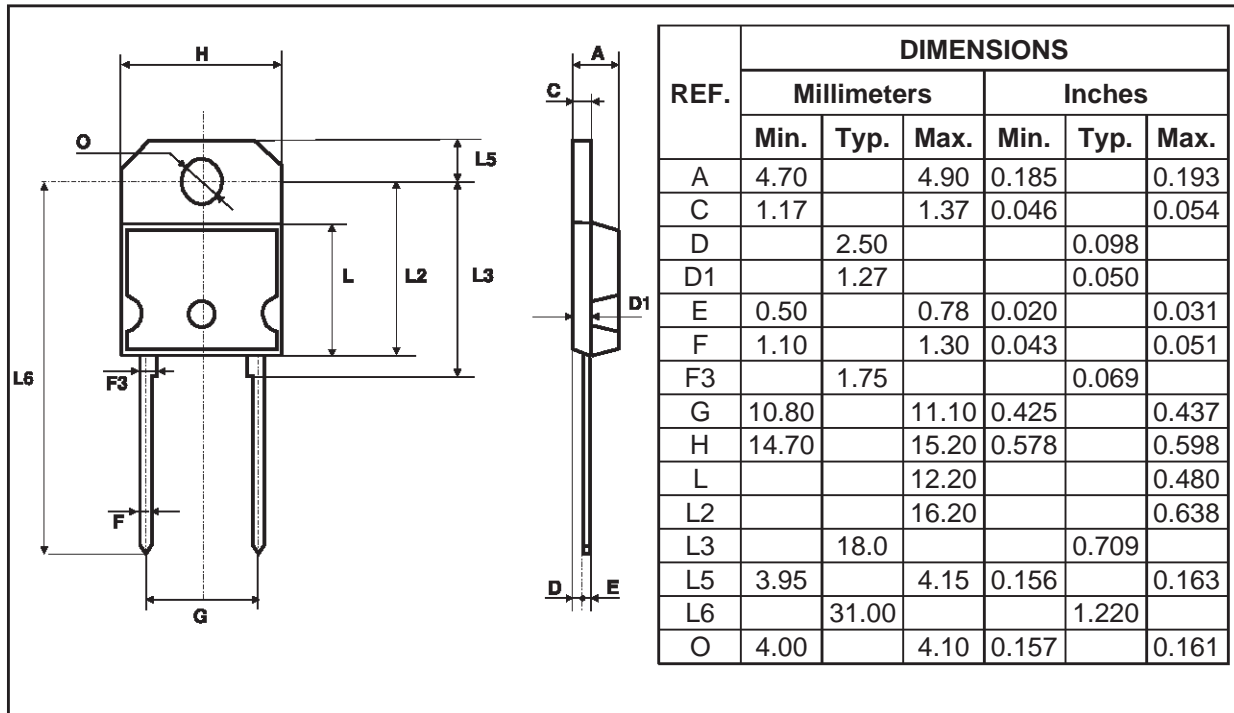
PACKAGE MECHANICAL DATA  
ISOTOP



REF.	DIMENSIONS			
	Millimeters		Inches	
	Min.	Max.	Min.	Max.
A	11.80	12.20	0.465	0.480
A1	8.90	9.10	0.350	0.358
B	7.8	8.20	0.307	0.323
C	0.75	0.85	0.030	0.033
C2	1.95	2.05	0.077	0.081
D	37.80	38.20	1.488	1.504
D1	31.50	31.70	1.240	1.248
E	25.15	25.50	0.990	1.004
E1	23.85	24.15	0.939	0.951
E2	24.80 typ.		0.976 typ.	
G	14.90	15.10	0.587	0.594
G1	12.60	12.80	0.496	0.504
G2	3.50	4.30	0.138	0.169
F	4.10	4.30	0.161	0.169
F1	4.60	5.00	0.181	0.197
P	4.00	4.30	0.157	0.69

**PACKAGE MECHANICAL DATA**

SOD93 Plastic



Ordering type	Marking	Package	Weight	Base qty	Delivery mode
BYT60P-400	BYT60P-400	SOD93	3.79 g.	30	Tube
BYT260PIV-400	BYT260PIV-400	ISOTOP	28 g. (without screws)	10	Tube
BYT261PIV-400	BYT261PIV-400	ISOTOP	28 g. (without screws)	10	Tube

- Cooling method: by conduction (C)
- Recommended torque value (ISOTOP): 1.3 N.m (MAX 1.5 N.m) for the 6 x M4 screws. (2 x M4 screws recommended for mounting the package on the heatsink and the 4 screws given with the screw version). The screws supplied with the package are adapted for mounting on a board (or other types of terminals) with a thickness of 0.6 mm min and 2.2 mm max.
- Recommended torque value (SOD93): 0.8 N.m.
- Maximum torque value (SOD93): 1.0 N.m.
- Epoxy meets UL94,V0

Information furnished is believed to be accurate and reliable. However, STMicroelectronics assumes no responsibility for the consequences of use of such information nor for any infringement of patents or other rights of third parties which may result from its use. No license is granted by implication or otherwise under any patent or patent rights of STMicroelectronics. Specifications mentioned in this publication are subject to change without notice. This publication supersedes and replaces all information previously supplied. STMicroelectronics products are not authorized for use as critical components in life support devices or systems without express written approval of STMicroelectronics.

The ST logo is a registered trademark of STMicroelectronics  
 © 2000 STMicroelectronics - Printed in Italy - All rights reserved.



STMicroelectronics GROUP OF COMPANIES  
 Australia - Brazil - China - Finland - France - Germany - Hong Kong - India - Italy - Japan - Malaysia  
 Malta - Morocco - Singapore - Spain - Sweden - Switzerland - United Kingdom - U.S.A.

<http://www.st.com>



## Looking for pricing, stock, or lifecycle information?

Click below to explore more details on WIN SOURCE:

-  [View BYT60P-400 on WIN SOURCE](#)
-  [STMicroelectronics](#) Information

## Optimize Your Supply Chain with WIN SOURCE Solutions

-  Global Sourcing Solution
-  Obsolete Management
-  Cost Control Management
-  Shortage Management
-  Alternative Solution
-  Excess Inventory Management