



**THE DATASHEET OF
Z1206C800APWST**





Surface Mount Ferrite Products

Inductors & Ferrite Beads

www.kemet.com

F3115D 1/08

The Capacitance Company
KEMET
CHARGED.™



Table of Contents

L-Wire Wound Chip Inductors - L-PW Series	Page 4
0805 Case Size Standard Type (L-PWS Series)	Page 5
0806 Case Size Standard Type (L-PWS Series)	Page 5
1007 Case Size Standard Type (L-PWS Series)	Page 5
1207 Case Size Standard Type (L-PWS Series)	Page 6
0603 Case Size Standard Type (L-PWF Series Bottom Surface Electrode)	Page 6
0805 Case Size High Current Type (L-PWI Series)	Page 6
0806 Case Size High Current Type (L-PWI Series)	Page 6
1007 Case Size High Current Type (L-PWI Series)	Page 7
0805 Case Size Low Rdc Type (L-PWR Series)	Page 7
1007 Case Size Low Rdc Type (L-PWR Series)	Page 7
L-Wire Wound Chip Inductors - L-DWS/L-DWI/L-DWL Series	Page 8
0805 Case Size Low Rdc Type (L-DWS Series)	Page 9
0806 Case Size Low Rdc Type (L-DWS Series)	Page 9
1007 Case Size Low Rdc Type (L-DWS Series)	Page 9
0805 Case Size High Current Type (L-DWI Series)	Page 9
0806 Case Size High Current Type (L-DWI Series)	Page 9
1007 Case Size High Current Type (L-DWI Series)	Page 10
1210 Case Size High Current Type (L-DWI Series)	Page 10
0805 Case Size Low Profile Type (L-DWL Series)	Page 10
0603 Case Size Power, Bottom Surface Electrode Type (L-DWF Series)	Page 10
L-Multilayer Chip Inductors for High Frequency - L-RMS Series	Page 11
0201 Case Size Multilayer Chip Inductors for High Frequency (RMS Series)	Page 12
0402 Case Size Multilayer Chip Inductors for High Frequency (RMS Series)	Page 13
0603 Case Size Multilayer Chip Inductors for High Frequency (RMS Series)	Page 14
0805 Case Size Multilayer Chip Inductors for High Frequency (RMS Series)	Page 15
L-Multilayer Chip Inductors - L-SMS/L-PMS/L-DMI Series	Page 16
0402 Case Size Multilayer Chip Inductors (L-SMS Series)	Page 17
0603 Case Size Multilayer Chip Inductors (L-SMS Series)	Page 18
0805 Case Size Multilayer Chip Inductors (L-SMS Series)	Page 19
0603 Case Size Multilayer Chip Inductors (L-PMS Series)	Page 20
0805 Case Size Multilayer Chip Inductors (L-PMS Series)	Page 20
1008 Case Size Multilayer Chip Inductors (L-DMI Series)	Page 20
L-Low Profile SMD Inductors (L-DWD Series)	Page 21
L-DWD3010 Type (1.0mm Max. Height)	Page 21
L-DWD4010 Type (1.0mm Max. Height)	Page 21
L-DWD4012 Type (1.2mm Max. Height)	Page 22
L-DWD4018 Type (1.8mm Max. Height)	Page 22
L-DWD8040 Type (4.2mm Max. Height)	Page 22
Z-High Current Ferrite Chip Beads - Z-PWS/Z-PWZ Series	Page 23
0603 Case Size High Current Ferrite Chip Beads (Z-PWS Series)	Page 24
0805 Case Size High Current Ferrite Chip Beads (Z-PWS Series)	Page 24
1206 Case Size High Current Ferrite Chip Beads (Z-PWS Series)	Page 24
1806 Case Size High Current Ferrite Chip Beads (Z-PWS Series)	Page 24
0603-1812 High Impedence Type Ferrite Chip Beads (Z-PWZ Series)	Page 25
Z-Multilayer Ferrite Chip Beads - Z-SMS/Z-PMS Series	Page 26
0201 Multilayer Ferrite Chip Beads Standard Type (SMS Series)	Page 27
0402 Multilayer Ferrite Chip Beads Standard Type (SMS Series)	Page 27
0402 Multilayer Ferrite Chip Beads for Power Lines (PMS Series)	Page 27
0603 Multilayer Ferrite Chip Beads Standard Type (SMS Series)	Page 28
0603 Multilayer Ferrite Chip Beads for Power Lines (PMS Series)	Page 28
0805 Multilayer Ferrite Chip Beads Standard Type (SMS Series)	Page 29
0805 Multilayer Ferrite Chip Beads for Power Lines (PMS Series)	Page 29

Wire Wound Chip Inductors - L-PWS/L-PWF/L-PWI/L-PWR Series

Features:

- Small size wound chip inductor with low DC resistance
- Dimension without directional influence on mountability and characteristics

Operating Temperature:

- -1 °C to +105°C (including self-generated heat)

Applications:

- Digital Still Cameras (DSC), Digital Video Cameras (DVC), PDA's and other portable digital equipment
- Portable telephones and wireless LAN

Part Numbering Table

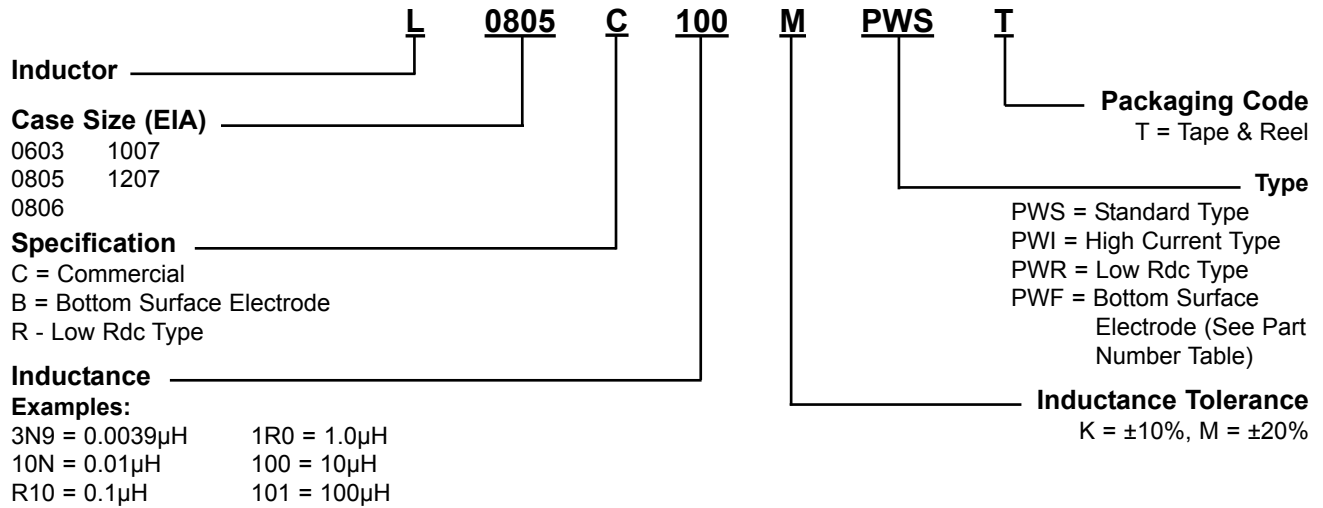

Dimension Table in millimeters (inches)

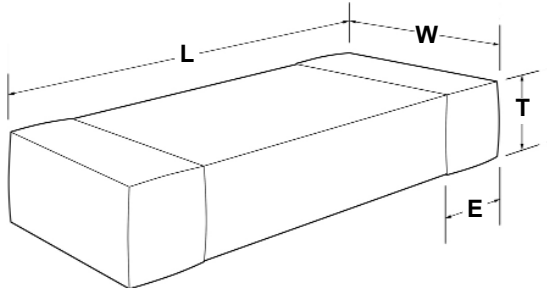

EIA Case Code	Metric Dim. Code	L Length (inches)	W Width (inches)	T Thickness Maximum (inches)	E (inches)
0603	1608	1.6 ±0.1 (0.063 ±0.004)	0.8 ±0.1 (0.031 ±0.004)	0.8 ±0.1 (0.031 ±0.004)	0.35 ±0.2 (0.014 ±0.008)
0805	2012	2.0 ±0.2 (0.079 ±0.008)	1.25 ±0.2 (0.049 ±0.008)	1.25 ±0.2 (0.049 ±0.008)	0.5 ±0.2 (0.02 ±0.008)
0806	2016	2.0 ±0.2 (0.079 ±0.008)	1.6 ±0.2 (0.063 ±0.008)	1.6 ±0.2 (0.063 ±0.008)	0.5 ±0.2 (0.02 ±0.008)
1007	2518	2.5 ±0.2 (0.098 ±0.008)	1.8 ±0.2 (0.072 ±0.008)	1.8 ±0.2 (0.072 ±0.008)	0.5 ±0.2 (0.02 ±0.008)
1207	3218	3.2 ±0.2 (0.128 ±0.008)	1.8 ±0.2 (0.072 ±0.008)	1.8 ±0.2 (0.072 ±0.008)	0.6 ±0.2 (0.024 ±0.008)

Wire Wound Chip Inductors - L-PWS, L-PWF, L-PWI, L-PWR Series

0805 Case Size Standard Type (L-PWS Series)

Ordering Code	Inductance (μ H)	Inductance Tolerance	Minimum Self Resonant Frequency (MHz)	DC Resistance (Ω) (\pm 30%)	Maximum Rated Current (mA)	Measuring Frequency (MHz)	Tape & Reel Packaging Quantity
L0805C1R0MPWST	1.0	\pm 20%	100	0.15	300	7.96	3,000
L0805C2R2MPWST	2.2	\pm 20%	80	0.23	240	7.96	3,000
L0805C4R7MPWST	4.7	\pm 20%	45	0.40	140	7.96	3,000
L0805C100MPWST	10	\pm 20%	32	0.70	100	2.52	3,000
L0805R100MPWST*	10	\pm 20%	32	0.50	100	2.52	3,000
L0805C220MPWST	22	\pm 20%	15	1.70	75	2.52	3,000
L0805C470MPWST	47	\pm 20%	11	3.70	50	2.52	3,000
L0805C101MPWST	100	\pm 20%	8	7.00	30	0.796	3,000

* Low Rdc type

0806 Case Size Standard Type (L-PWS Series)

Ordering Code	Inductance (μ H)	Inductance Tolerance	Minimum Self Resonant Frequency (MHz)	DC Resistance (Ω) (\pm 30%)	Maximum Rated Current (mA)	Measuring Frequency (MHz)	Tape & Reel Packaging Quantity
L0806C1R0MPWST	1.0	\pm 20%	100	0.09	455	7.96	2,000
L0806C1R5MPWST	1.5	\pm 20%	80	0.11	350	7.96	2,000
L0806C2R2MPWST	2.2	\pm 20%	70	0.13	315	7.96	2,000
L0806C3R3MPWST	3.3	\pm 20%	55	0.20	280	7.96	2,000
L0806C4R7MPWST	4.7	\pm 20%	45	0.25	210	7.96	2,000
L0806C6R8MPWST	6.8	\pm 20%	38	0.35	175	7.96	2,000
L0806C100MPWST	10	\pm 20%	32	0.50	155	2.52	2,000
L0806C150MPWST	15	\pm 20%	28	0.70	130	2.52	2,000
L0806C220MPWST	22	\pm 20%	16	1.00	105	2.52	2,000
L0806C330MPWST	33	\pm 20%	14	1.70	85	2.52	2,000
L0806C470MPWST	47	\pm 20%	11	2.40	60	2.52	2,000
L0806C680MPWST	68	\pm 20%	10	3.00	50	2.52	2,000
L0806C101MPWST	100	\pm 20%	8	4.50	40	0.796	2,000

1007 Case Size Standard Type (L-PWS Series)

Ordering Code	Inductance (μ H)	Inductance Tolerance	Minimum Self Resonant Frequency (MHz)	DC Resistance (Ω) (\pm 30%)	Maximum Rated Current (mA)	Measuring Frequency (MHz)	Tape & Reel Packaging Quantity
L1007C1R0MPWST	1.0	\pm 20%	100	0.06	500	7.96	2,000
L1007C1R5MPWST	1.5	\pm 20%	80	0.07	400	7.96	2,000
L1007C2R2MPWST	2.2	\pm 20%	68	0.09	340	7.96	2,000
L1007C3R3MPWST	3.3	\pm 20%	54	0.11	270	7.96	2,000
L1007C4R7MPWST	4.7	\pm 20%	46	0.13	240	7.96	2,000
L1007R4R7MPWST	4.7	\pm 20%	46	0.10	235	7.96	2,000
L1007C6R8MPWST	6.8	\pm 20%	38	0.15	195	7.96	2,000
L1007C100MPWST	10	\pm 20%	30	0.25	165	2.52	2,000
L1007C150MPWST	15	\pm 20%	23	0.32	145	2.52	2,000
L1007C220MPWST	22	\pm 20%	19	0.50	115	2.52	2,000
L1007C330MPWST	33	\pm 20%	15	0.70	95	2.52	2,000
L1007C470MPWST	47	\pm 20%	12	0.95	85	2.52	2,000
L1007C680MPWST	68	\pm 20%	9.5	1.50	70	2.52	2,000
L1007C101MPWST	100	\pm 20%	9	2.10	55	0.796	2,000
L1007C151MPWST	150	\pm 20%	7	3.20	45	0.796	2,000
L1007C221MPWST	220	\pm 20%	5.5	4.50	35	0.796	2,000
L1007C331MPWST	330	\pm 20%	4.5	7.00	30	0.796	2,000
L1007C471MPWST	470	\pm 20%	3.5	10.00	25	0.796	2,000
L1007C681MPWST	680	\pm 20%	3	17.00	20	0.796	2,000
L1007C102MPWST	1000	\pm 20%	2.4	24.00	15	0.252	2,000

1207 Case Size Standard Type (L-PWS Series)

Ordering Code	Inductance (μH)	Inductance Tolerance	Minimum Self Resonant Frequency (MHz)	DC Resistance (Ω) (±30%)	Maximum Rated Current (mA)	Measuring Frequency (MHz)	Tape & Reel Packaging Quantity
L1207C1R0MPWST	1.0	±20%	100	0.06	1075	7.96	2,000
L1207C1R5MPWST	1.5	±20%	80	0.07	860	7.96	2,000
L1207C2R2MPWST	2.2	±20%	68	0.09	775	7.96	2,000
L1207C3R3MPWST	3.3	±20%	54	0.11	560	7.96	2,000
L1207C4R7MPWST	4.7	±20%	41	0.13	550	7.96	2,000
L1207C6R8MPWST	6.8	±20%	40	0.17	380	7.96	2,000
L1207C100()PWST	10	K=±10%, M=±20%	30	0.25	340	2.52	2,000
L1207C150()PWST	15	K=±10%, M=±20%	25	0.32	300	2.52	2,000
L1207C220()PWST	22	K=±10%, M=±20%	19	0.49	255	2.52	2,000
L1207C330()PWST	33	K=±10%, M=±20%	15	0.75	215	2.52	2,000
L1207C470()PWST	47	K=±10%, M=±20%	12	0.92	205	2.52	2,000
L1207C680()PWST	68	K=±10%, M=±20%	11	1.49	145	2.52	2,000
L1207C101()PWST	100	K=±10%, M=±20%	8	2.40	140	0.796	2,000
L1207C151()PWST	150	K=±10%, M=±20%	7	3.20	105	0.796	2,000
L1207C221()PWST	220	K=±10%, M=±20%	5	5.40	80	0.796	2,000
L1207C331()PWST	330	K=±10%, M=±20%	4	7.00	65	0.796	2,000
L1207C471()PWST	470	K=±10%, M=±20%	3.5	14.00	54	0.796	2,000
L1207C681()PWST	680	K=±10%, M=±20%	3	17.00	45	0.796	2,000
L1207C102()PWST	1000	K=±10%, M=±20%	2.4	27.00	39	0.252	2,000

() - Insert Inductance Tolerance Code (K or M)

0603 Case Size Standard Type (L-PWF Series - Bottom Surface Electrodes)

Ordering Code	Inductance (μH)	Inductance Tolerance	Minimum Self Resonant Frequency (MHz)	DC Resistance (Ω) (±30%)	Maximum Rated Current (mA)	Measuring Frequency (MHz)	Tape & Reel Packaging Quantity
L0603B1R0MPWFT	1.0	±20%	100	0.19	620	7.96	3,000
L0603B2R2MPWFT	2.2	±20%	70	0.33	430	7.96	3,000
L0603B4R7MPWFT	4.7	±20%	45	0.50	295	7.96	3,000
L0603B100()PWFT	10	K=±10%, M=±20%	40	1.20	200	2.52	3,000
L0603B220()PWFT	22	K=±10%, M=±20%	16	3.70	130	2.52	3,000
L0603B470()PWFT	47	K=±10%, M=±20%	11	5.80	90	2.52	3,000

() - Insert Inductance Tolerance Code (K or M)

0805 Case Size High Current Type (L-PWI Series)

Ordering Code	Inductance (μH)	Inductance Tolerance	Minimum Self Resonant Frequency (MHz)	DC Resistance (Ω) (±30%)	Maximum Rated Current (mA)	Measuring Frequency (MHz)	Tape & Reel Packaging Quantity
L0805C1R0MPWIT	1.0	±20%	100	0.19	620	7.96	3,000
L0805C2R2MPWIT	2.2	±20%	70	0.33	430	7.96	3,000
L0805C4R7MPWIT	4.7	±20%	45	0.50	295	7.96	3,000
L0805C100MPWIT	10	±20%	40	1.20	200	2.52	3,000
L0805C220MPWIT	22	±20%	16	3.70	130	2.52	3,000
L0805C470MPWIT	47	±20%	11	5.80	90	2.52	3,000

0806 Case Size High Current Type (L-PWI Series)

Ordering Code	Inductance (μH)	Inductance Tolerance	Minimum Self Resonant Frequency (MHz)	DC Resistance (Ω) (±30%)	Maximum Rated Current (mA)	Measuring Frequency (MHz)	Tape & Reel Packaging Quantity
L0806C1R0MPWIT	1.0	±20%	100	0.10	690	7.96	2,000
L0806C1R5MPWIT	1.5	±20%	80	0.15	600	7.96	2,000
L0806C2R2MPWIT	2.2	±20%	70	0.20	520	7.96	2,000
L0806C3R3MPWIT	3.3	±20%	55	0.27	410	7.96	2,000
L0806C4R7MPWIT	4.7	±20%	45	0.37	355	7.96	2,000
L0806C6R8MPWIT	6.8	±20%	38	0.59	290	7.96	2,000
L0806C100MPWIT	10	±20%	32	0.82	245	2.52	2,000
L0806C150MPWIT	15	±20%	28	1.20	200	2.52	2,000
L0806C220MPWIT	22	±20%	16	1.80	165	2.52	2,000
L0806C330MPWIT	33	±20%	14	2.80	135	2.52	2,000
L0806C470MPWIT	47	±20%	11	4.30	110	2.52	2,000
L0806C680MPWIT	68	±20%	10	7.00	95	2.52	2,000
L0806C101MPWIT	100	±20%	8	8.00	75	0.796	2,000

Wire Wound Chip Inductors - L-PWS, L-PWF, L-PWI, L-PWR Series

1007 Case Size High Current Type (L-PWI Series)

Ordering Code	Inductance (μH)	Inductance Tolerance	Minimum Self Resonant Frequency (MHz)	DC Resistance (Ω) (±30%)	Maximum Rated Current (mA)	Measuring Frequency (MHz)	Tape & Reel Packaging Quantity
L1007C1R0MPWIT	1.0	±20%	100	0.08	775	7.96	2,000
L1007R1R0MPWIT*	1.0	±20%	100	0.065	890	7.96	2,000
L1007C1R5MPWIT	1.5	±20%	80	0.11	660	7.96	2,000
L1007C2R2MPWIT	2.2	±20%	68	0.13	600	7.96	2,000
L1007C3R3MPWIT	3.3	±20%	54	0.16	500	7.96	2,000
L1007C4R7MPWIT	4.7	±20%	41	0.20	430	7.96	2,000
L1007C6R8MPWIT	6.8	±20%	38	0.30	360	7.96	2,000
L1007C100MPWIT	10	±20%	30	0.36	300	2.52	2,000
L1007C150MPWIT	15	±20%	23	0.65	250	2.52	2,000
L1007C220MPWIT	22	±20%	19	0.77	210	2.52	2,000
L1007C330MPWIT	33	±20%	15	1.50	170	2.52	2,000
L1007C470MPWIT	47	±20%	12	1.90	150	2.52	2,000
L1007C680MPWIT	68	±20%	9.5	2.80	120	2.52	2,000
L1007C101MPWIT	100	±20%	9.0	3.70	100	0.796	2,000
L1007C151MPWIT	150	±20%	7.0	6.10	85	0.796	2,000
L1007C221MPWIT	220	±20%	5.5	8.40	70	0.796	2,000
L1007C331MPWIT	330	±20%	4.5	12.30	60	0.796	2,000
L1007C471MPWIT	470	±20%	3.5	22.00	45	0.796	2,000
L1007C681MPWIT	680	±20%	3.0	28.00	35	0.796	2,000

* Low Rdc Type

0805 Case Size Low Rdc Type (L-PWR Series)

Ordering Code	Inductance (μH)	Inductance Tolerance	Minimum Self Resonant Frequency (MHz)	DC Resistance (Ω) (±30%)	Maximum Rated Current (mA)	Measuring Frequency (MHz)	Tape & Reel Packaging Quantity
L0805R1R0MPWRT	1.0	±20%	100	0.07	200	7.96	3,000
L0805R2R2MPWRT	2.2	±20%	80	0.13	175	7.96	3,000
L0805R4R7MPWRT	4.7	±20%	45	0.24	150	7.96	3,000
L0805R100MPWRT	10	±20%	32	0.36	125	2.52	3,000
L0805R220MPWRT	22	±20%	16	1.00	100	2.52	3,000
L0805R470MPWRT	47	±20%	11	1.70	75	2.52	3,000
L0805R101MPWRT	100	±20%	8	4.00	50	0.796	3,000

1007 Case Size Low Rdc Type (L-PWR Series)

Ordering Code	Inductance (μH)	Inductance Tolerance	Minimum Self Resonant Frequency (MHz)	DC Resistance (Ω) (±30%)	Maximum Rated Current (mA)	Measuring Frequency (MHz)	Tape & Reel Packaging Quantity
L1007R1R0MPWRT	1.0	±20%	100	0.045	400	7.96	2,000
L1007R2R2MPWRT	2.2	±20%	68	0.07	280	7.96	2,000
L1007R4R7MPWRT	4.7	±20%	45	0.1	200	7.96	2,000
L1007R100MPWRT	10	±20%	30	0.19	180	2.52	2,000
L1007R220MPWRT	22	±20%	19	0.44	120	2.52	2,000
L1007R470MPWRT	47	±20%	11	0.84	95	2.52	2,000
L1007R101MPWRT	100	±20%	9	1.89	75	0.796	2,000

Wire Wound Chip Inductors - L-DWS/L-DWI/L-DWL/L-DWF Series

Features:

- Small size wound chip inductor with high current
- Dimension without directional influence on mountability and characteristics

Operating Temperature:

- -1 °C to +105°C (including self-generated heat)

Applications:

- Digital Still Cameras (DSC), Digital Video Cameras (DVC), PDA's and other portable digital equipment
- For DC-DC converter circuit

Part Numbering Table

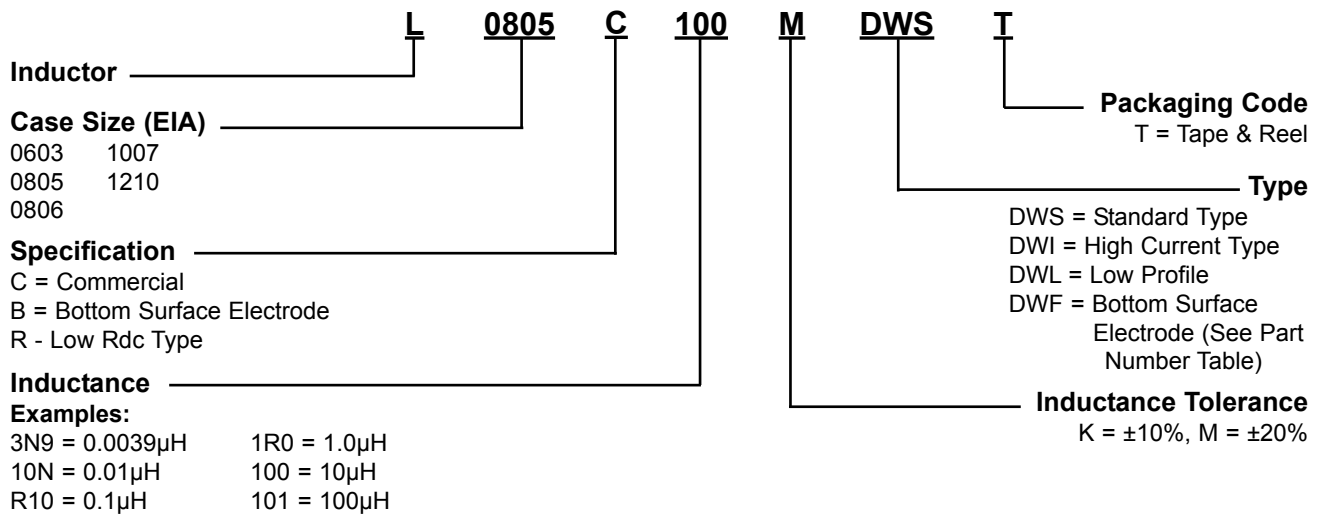

Dimension Table in millimeters (inches)

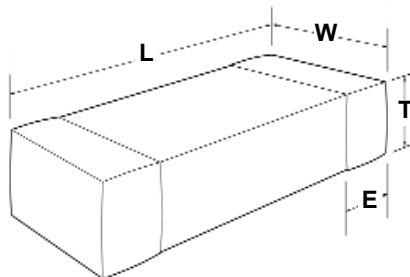

EIA Case Size	Metric Dim. Code	L Length (inches)	W Width (inches)	T Thickness Maximum (inches)	E (inches)
0603	1608	1.6 ±0.2 (0.063 ±0.008)	0.8 ±0.2 (0.031 ±0.008)	0.8 ±0.2 (0.031 ±0.008)	0.4 ±0.15 (0.015 ±0.006)
0805	2012	2.0 ±0.2 (0.079 ±0.008)	1.25 ±0.2 (0.049 ±0.008)	1.25 ±0.2 (0.049 ±0.008)	0.5 ±0.2 (0.02 ±0.008)
0806	2016	2.0 ±0.2 (0.079 ±0.008)	1.6 ±0.2 (0.063 ±0.008)	1.6 ±0.2 (0.063 ±0.008)	0.5 ±0.2 (0.02 ±0.008)
1007	2518	2.5 ±0.2 (0.098 ±0.008)	1.8 ±0.2 (0.071 ±0.008)	1.8 ±0.2 (0.071 ±0.008)	0.5 ±0.2 (0.02 ±0.008)
1210	3225	3.2 ±0.2 (0.126 ±0.008)	2.5 ±0.2 (0.098 ±0.008)	2.5 ±0.2 (0.098 ±0.008)	0.6 ±0.3 (0.024 ±0.012)

Wire Wound Chip Inductors - L-DWS, L-DWI, L-DWL, L-DWF Series

0805 Case Size Standard Type (L-DWS Series)

Ordering Code	Inductance (μH)	Inductance Tolerance	Minimum Self Resonant Frequency (MHz)	DC Resistance (Ω) (±30%)	Maximum Rated Current (mA)		Measuring Frequency (MHz)	Tape & Reel Packaging Quantity
					1	2		
L0805C2R2MDWST	2.2	±20%	80	0.23	410	770	7.96	3,000
L0805C4R7MDWST	4.7	±20%	45	0.40	300	580	7.96	3,000
L0805R100MDWST	10	±20%	32	0.50	200	520	2.52	3,000
L0805C220MDWST	22	±20%	16	1.70	135	280	2.52	3,000
L0805C470MDWST	47	±20%	11	3.70	90	190	2.52	3,000

0806 Case Size Standard Type (L-DWS Series)

Ordering Code	Inductance (μH)	Inductance Tolerance	Minimum Self Resonant Frequency (MHz)	DC Resistance (Ω) (±30%)	Maximum Rated Current (mA)		Measuring Frequency (MHz)	Tape & Reel Packaging Quantity
					1	2		
L0806C2R2MDWST	2.2	±20%	70	0.13	510	1000	7.96	2,000
L0806C4R7MDWST	4.7	±20%	45	0.25	340	740	7.96	2,000
L0806C100MDWST	10	±20%	32	0.50	250	520	2.52	2,000
L0806C220MDWST	22	±20%	16	1.00	165	370	2.52	2,000
L0806C470MDWST	47	±20%	11	2.40	110	240	2.52	2,000

1007 Case Size Standard Type (L-DWS Series)

Ordering Code	Inductance (μH)	Inductance Tolerance	Minimum Self Resonant Frequency (MHz)	DC Resistance (Ω) (±30%)	Maximum Rated Current (mA)		Measuring Frequency (MHz)	Tape & Reel Packaging Quantity
					1	2		
L1007C2R2MDWST	2.2	±20%	68	0.09	510	1300	7.96	2,000
L1007C4R7MDWST	4.7	±20%	46	0.13	340	1100	7.96	2,000
L1007C100MDWST	10	±20%	30	0.25	250	820	2.52	2,000
L1007C220MDWST	22	±20%	19	0.50	165	580	2.52	2,000
L1007C470MDWST	47	±20%	12	0.95	110	420	2.52	2,000

0805 Case Size High Current Type (L-DWI Series)

Ordering Code	Inductance (μH)	Inductance Tolerance	Minimum Self Resonant Frequency (MHz)	DC Resistance (Ω) (±30%)	Maximum Rated Current (mA)		Measuring Frequency (MHz)	Tape & Reel Packaging Quantity
					1	2		
L0805C1R0MDWIT	1.0	±20%	100	0.19	700	840	7.96	3,000
L0805C2R2MDWIT	2.2	±20%	70	0.33	530	640	7.96	3,000
L0805C4R7MDWIT	4.7	±20%	45	0.50	360	520	7.96	3,000
L0805C100MDWIT	10	±20%	40	1.20	240	340	2.52	3,000
L0805C220MDWIT	22	±20%	16	3.70	170	190	2.52	3,000
L0805C470MDWIT	47	±20%	11	5.80	120	150	2.52	3,000

0806 Case Size High Current Type (L-DWI Series)

Ordering Code	Inductance (μH)	Inductance Tolerance	Minimum Self Resonant Frequency (MHz)	DC Resistance (Ω) (±30%)	Maximum Rated Current (mA)		Measuring Frequency (MHz)	Tape & Reel Packaging Quantity
					1	2		
L0806C1R0MDWIT	1.0	±20%	100	0.1	1100	1100	7.96	3,000
L0806C1R5MDWIT	1.5	±20%	80	0.15	1000	1000	7.96	3,000
L0806C2R2MDWIT	2.2	±20%	70	0.20	750	720	7.96	3,000
L0806C3R3MDWIT	3.3	±20%	55	0.27	600	610	7.96	3,000
L0806C4R7MDWIT	4.7	±20%	45	0.37	550	530	7.96	3,000
L0806C6R8MDWIT	6.8	±20%	38	0.59	450	450	7.96	3,000
L0806C100()DWIT	10	K=±10%, M=±20%	32	0.82	380	350	2.52	3,000
L0806C150()DWIT	15	K=±10%, M=±20%	28	1.2	300	300	2.52	3,000
L0806C220()DWIT	22	K=±10%, M=±20%	16	1.8	250	240	2.52	3,000
L0806C330()DWIT	33	K=±10%, M=±20%	14	2.8	220	220	2.52	3,000
L0806C470()DWIT	47	K=±10%, M=±20%	11	4.3	150	150	2.52	3,000
L0806C680()DWIT	68	K=±10%, M=±20%	10	7	130	130	2.52	3,000
L0806C101()DWIT	100	K=±10%, M=±20%	8	8	110	110	0.796	3,000

() - Insert Inductance Tolerance Code (K or M)

*For rated current of ordinary small power choke coils, please refer to the rated current (1) in the above table.

*For current (2) is the current for instantaneous flow such as plunging current of DC/DC converter.

In case of usage in the circuit where large current may be semicontinuously applied over 5 minutes with auto recovery circuit, etc, please contact our sales section before practical application.

Rated current (1):Current value to guarantee -30% of nominal inductance

Rated current (2):Current value to guarantee component temperature within ΔT = 40°C with current flow. (It's not the current to guarantee the inductance value)

1007 Case Size High Current Type (L-DWI Series)

Ordering Code	Inductance (µH)	Inductance Tolerance	Minimum Self Resonant Frequency (MHz)	DC Resistance (Ω) (±30%)	Maximum Rated Current (mA)		Measuring Frequency (MHz)	Tape & Reel Packaging Quantity
					1	2		
L1007C1R0MDWIT	1.0	±20%	100	0.08	1000	1200	7.96	2,000
L1007C2R2MDWIT	2.2	±20%	68	0.13	890	1100	7.96	2,000
L1007C4R7MDWIT	4.7	±20%	41	0.20	680	920	7.96	2,000
L1007C100MDWIT	10	±20%	30	0.36	480	680	2.52	2,000
L1007C220MDWIT	22	±20%	19	0.77	320	460	2.52	2,000
L1007C470MDWIT	47	±20%	12	1.90	240	290	2.52	2,000
L1007C101MDWIT	100	±20%	9	3.7	160	170	0.796	2,000
L1007C220MDWIT	220	±20%	5.5	8.4	115	110	0.796	2,000
L1007C470MDWIT	470	±20%	3.5	22	80	70	0.796	2,000
L1007C681MDWIT	680	±20%	3	28	65	60	0.796	2,000

1210 Case Size High Current Low Rdc Type (L-DWI Series)

Ordering Code	Inductance (µH)	Inductance Tolerance	Minimum Self Resonant Frequency (MHz)	DC Resistance (Ω) (±30%)	Maximum Rated Current (mA)		Measuring Frequency (MHz)	Tape & Reel Packaging Quantity
					1	2		
L1210R1R0MDWIT	1.0	±20%	250	0.055	2000	1440	0.1	1,000
L1210R1R5MDWIT	1.5	±20%	220	0.06	2000	1310	0.1	1,000
L1210R2R2MDWIT	2.2	±20%	190	0.08	2000	1130	0.1	1,000
L1210R3R3MDWIT	3.3	±20%	160	0.095	1800	1040	0.1	1,000
L1210R4R7MDWIT	4.7	±20%	70	0.1	1250	1010	0.1	1,000
L1210R6R8MDWIT	6.8	±20%	50	0.12	930	940	0.1	1,000
L1210R100()DWIT	10	K=±10%, M=±20%	23	0.133	900	900	0.1	1,000
L1210R150()DWIT	15	K=±10%, M=±20%	20	0.195	730	850	0.1	1,000
L1210R220()DWIT	22	K=±10%, M=±20%	17	0.27	620	780	0.1	1,000
L1210R330()DWIT	33	K=±10%, M=±20%	13	0.41	500	570	0.1	1,000
L1210R470()DWIT	47	K=±10%, M=±20%	10	0.67	390	480	0.1	1,000
L1210R680()DWIT	68	K=±10%, M=±20%	8	1	320	410	0.1	1,000
L1210R101()DWIT	100	K=±10%, M=±20%	6	1.4	270	340	0.1	1,000

() - Insert Inductance Tolerance Code (K or M)

0805 Case Size Low Profile Type (L-DWL Series)

Ordering Code	Inductance (µH)	Inductance Tolerance	Minimum Self Resonant Frequency (MHz)	DC Resistance (Ω) (±30%)	Maximum Rated Current (mA)		Measuring Frequency (MHz)	Tape & Reel Packaging Quantity
					1	2		
L0805C4R7MDWLT	4.7	±20%	45	0.66	275	490	0.10	4,000
L0805C100MDWLT	10	±20%	32	1.00	205	370	0.10	4,000
L0805C470MDWLT	47	±20%	11	4.20	100	140	0.10	4,000

0603 Case Size Power, Bottom Surface Electrode Type (L-DWF 1608 Series)

Ordering Code	Inductance (µH)	Inductance Tolerance	Minimum Self Resonant Frequency (MHz)	DC Resistance (Ω) (±30%)	Maximum Rated Current (mA)		Measuring Frequency (MHz)	Tape & Reel Packaging Quantity
					1	2		
L0603B1R0MDWFT	1.0	±20%	100	0.09	290	770	7.96	2,000
L0603B2R2MDWFT	2.2	±20%	80	0.17	190	560	7.96	2,000
L0603B4R7MDWFT	4.7	±20%	45	0.24	145	470	7.96	2,000
L0603B100()DWFT	10	K=±10%, M=±20%	32	0.36	115	380	2.52	2,000
L0603B220()DWFT	22	K=±10%, M=±20%	16	1.00	70	230	2.52	2,000
L0603B470()DWFT	47	K=±10%, M=±20%	11	2.5	50	140	2.52	2,000

() - Insert Inductance Tolerance Code (K or M)

*For rated current of ordinary small power choke coils, please refer to the rated current (1) in the above table.

*For current (2) is the current for instantaneous flow such as plunging current of DC/DC converter.

In case of usage in the circuit where large current may be semicontinuously applied over 5 minutes with auto recovery circuit, etc, please contact our sales section before practical application.

Rated current (1): Current value to guarantee -30% of nominal inductance (at 20°C)

Rated current (2): Current value to guarantee component temperature within ΔT = 40°C with current flow. (It's not the current to guarantee the inductance value)

Multilayer Chip Inductors for High Frequency - L-RMS Series

Features:

- Multilayer inductor made of advanced ceramics with low resistivity silver used as internal conductors, provides excellent Q and SRF characteristics
- Multilayer block structure ensures outstanding reliability, high productivity and excellent product quality

Operating Temperature:

- 0201: -55°C to +125°C
- 0402: -55°C to +125°C
- 0805: -40°C to +85°C

Applications:

- Designed to address surface mount inductor needs for applications above 100MHz
- Mobile phones and pagers
- High frequency circuits
- EMI counter measures in high frequency circuits

Part Numbering Table

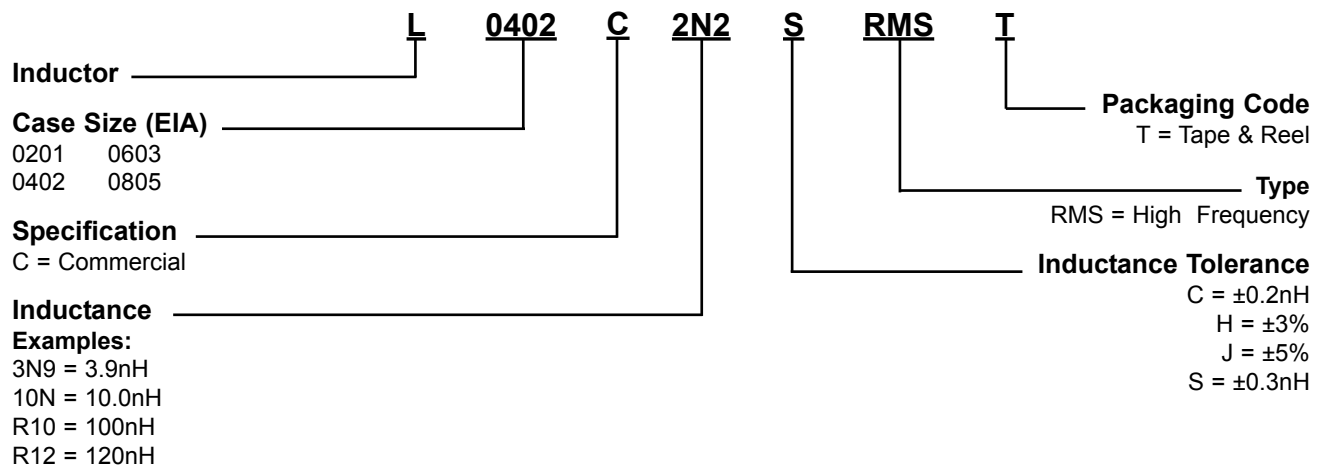

Dimension Table in millimeters (inches)

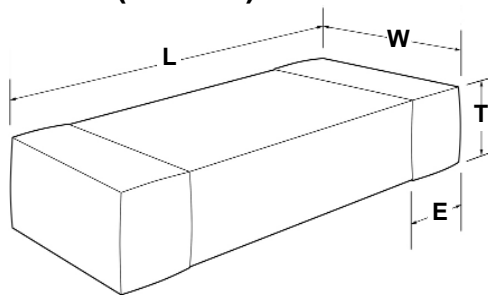

EIA Case Size	Metric Dim. Code	L Length (inches)	W Width (inches)	T Thickness Maximum (inches)	E (inches)
0201	0603	0.6 ±0.03 (0.024 ±0.001)	0.3 ±0.03 (0.012 ±0.001)	0.3 ±0.03 (0.012 ±0.001)	0.15 ±0.05 (0.006 ±0.002)
0402	1005	1.0 ±0.05 (0.039 ±0.002)	0.5 ±0.05 (0.02 ±0.002)	0.5 ±0.05 (0.02 ±0.002)	0.25 ±0.10 (0.01 ±0.004)
0603	1608	1.6 ±0.15 (0.063 ±0.006)	0.8 ±0.15 (0.031 ±0.006)	0.8 ±0.15 (0.031 ±0.006)	0.3 ±0.2 (0.012 ±0.008)
0805	2125	2.0 +0.3/-0.1 (0.079 +0.012/-0.004)	1.25 ±0.2 (0.049 ±0.008)	0.85 ±0.2 1.0 +0.2/-0.3 (0.033 ±0.008) (0.039 +0.008/-0.012)	0.5 ±0.3 (0.020 ±0.012)

0201 Case Size Multilayer Chip Inductors for High Frequency (L-RMS Series)

Ordering Code	Inductance (nH)	Inductance Tolerance	Q min.	Measuring Frequency (MHz)	Typical Q					Self-resonant Frequency (MHz)		DC Resistance (Ω)		Maximum Rated Current (mA)	Thickness mm (inches)	Tape & Reel Packaging Quantity
					Frequency (MHz)					min.	typ.	max.	typ.			
					100	300	500	800	1000							
L0201C1N0SRMST	1.0	$\pm 0.3nH$	4	100	6	12	17	22	27	10000	>13000	0.14	0.088	250	0.30 \pm 0.03 (0.012 \pm 0.001)	15,000
L0201C1N2SRMST	1.2	$\pm 0.3nH$	4	100	6	12	16	21	25	10000	>13000	0.14	0.089	250	0.30 \pm 0.03 (0.012 \pm 0.001)	15,000
L0201C1N5SRMST	1.5	$\pm 0.3nH$	4	100	6	12	15	20	23	10000	>13000	0.18	0.11	230	0.30 \pm 0.03 (0.012 \pm 0.001)	15,000
L0201C1N8SRMST	1.8	$\pm 0.3nH$	4	100	6	12	15	20	23	10000	>13000	0.19	0.12	200	0.30 \pm 0.03 (0.012 \pm 0.001)	15,000
L0201C2N2SRMST	2.2	$\pm 0.3nH$	4	100	6	12	15	20	22	8800	12500	0.22	0.14	200	0.30 \pm 0.03 (0.012 \pm 0.001)	15,000
L0201C2N7SRMST	2.7	$\pm 0.3nH$	5	100	7	12	15	20	22	7700	11000	0.25	0.16	200	0.30 \pm 0.03 (0.012 \pm 0.001)	15,000
L0201C3N3SRMST	3.3	$\pm 0.3nH$	5	100	7	12	15	20	22	6700	9600	0.30	0.19	180	0.30 \pm 0.03 (0.012 \pm 0.001)	15,000
L0201C3N9SRMST	3.9	$\pm 0.3nH$	5	100	7	12	15	20	22	6000	8600	0.30	0.20	170	0.30 \pm 0.03 (0.012 \pm 0.001)	15,000
L0201C4N7SRMST	4.7	$\pm 0.3nH$	5	100	7	12	15	19	21	5300	7600	0.40	0.25	150	0.30 \pm 0.03 (0.012 \pm 0.001)	15,000
L0201C5N6SRMST	5.6	$\pm 0.3nH$	5	100	7	12	15	19	21	4600	6600	0.40	0.25	150	0.30 \pm 0.03 (0.012 \pm 0.001)	15,000
L0201C6N8JRMST	6.8	$\pm 5\%$	5	100	7	11	14	18	20	3900	5600	0.48	0.30	150	0.30 \pm 0.03 (0.012 \pm 0.001)	15,000
L0201C8N2JRMST	8.2	$\pm 5\%$	5	100	7	11	14	18	19	3400	4900	0.55	0.34	150	0.30 \pm 0.03 (0.012 \pm 0.001)	15,000
L0201C10NJRMST	10	$\pm 5\%$	5	100	7	11	14	17	18	2900	4200	0.63	0.39	150	0.30 \pm 0.03 (0.012 \pm 0.001)	15,000
L0201C12NJRMST	12	$\pm 5\%$	5	100	7	11	14	17	18	2700	3800	0.70	0.45	100	0.30 \pm 0.03 (0.012 \pm 0.001)	15,000
L0201C15NJRMST	15	$\pm 5\%$	5	100	7	11	13	16	17	2300	3300	0.80	0.50	100	0.30 \pm 0.03 (0.012 \pm 0.001)	15,000
L0201C18NJRMST	18	$\pm 5\%$	5	100	7	11	13	16	17	2100	3000	0.90	0.57	100	0.30 \pm 0.03 (0.012 \pm 0.001)	15,000
L0201C22NJRMST	22	$\pm 5\%$	5	100	7	11	13	15	16	1800	2600	1.20	0.71	100	0.30 \pm 0.03 (0.012 \pm 0.001)	15,000
L0201C27NJRMST	27	$\pm 5\%$	4	100	6	10	12	14	15	1800	2600	1.80	1.11	50	0.30 \pm 0.03 (0.012 \pm 0.001)	15,000
L0201C33NJRMST	33	$\pm 5\%$	4	100	6	10	12	14	14	1700	2400	2.10	1.33	50	0.30 \pm 0.03 (0.012 \pm 0.001)	15,000
L0201C39NJRMST	39	$\pm 5\%$	4	100	6	10	12	13	12	1500	2100	2.40	1.51	50	0.30 \pm 0.03 (0.012 \pm 0.001)	15,000
L0201C47NJRMST	47	$\pm 5\%$	4	100	6	10	11	12	11	1300	1800	2.80	1.74	50	0.30 \pm 0.03 (0.012 \pm 0.001)	15,000
L0201C56NJRMST	56	$\pm 5\%$	4	100	6	10	11	11	10	1100	1600	3.00	1.85	50	0.30 \pm 0.03 (0.012 \pm 0.001)	15,000
L0201C68NJRMST	68	$\pm 5\%$	4	100	6	10	11	11	10	1100	1500	3.00	2.30	50	0.30 \pm 0.03 (0.012 \pm 0.001)	15,000
L0201C82NJRMST	82	$\pm 5\%$	4	100	6	10	11	10	8	1000	1400	3.50	2.60	50	0.30 \pm 0.03 (0.012 \pm 0.001)	15,000
L0201CR10JRMST	100	$\pm 5\%$	4	100	6	9	10	9	6	900	1200	4.00	3.00	40	0.30 \pm 0.03 (0.012 \pm 0.001)	15,000

Multilayer Chip Inductors - High Frequency - L-RMS Series

0402 Case Size Multilayer Chip Inductors for High Frequency (L-RMS Series)

Ordering Code	Inductance (nH)	Inductance Tolerance	Q min.	Measuring Frequency (MHz)	Typical Q					Self-resonant Frequency (MHz)		DC Resistance (Ω)		Maximum Rated Current (mA)		Thickness mm (inches)	Tape & Reel Packaging Quantity
					Frequency (MHz)					min.	typ.	max.	typ.	-55° to 125°C	-55° to 85°C		
					100	300	500	800	1000								
L0402C1N0SRMST	1.0	±0.3nH	8	100	11	25	34	43	52	10000	>13000	0.08	0.04	300	900	0.50 ±0.05 (0.02 ±0.002)	10,000
L0402C1N2SRMST	1.2	±0.3nH	8	100	11	25	35	44	52	10000	>13000	0.09	0.04	300	900	0.50 ±0.05 (0.02 ±0.002)	10,000
L0402C1N5SRMST	1.5	±0.3nH	8	100	11	24	33	44	48	6000	>13000	0.10	0.05	300	850	0.50 ±0.05 (0.02 ±0.002)	10,000
L0402C1N8SRMST	1.8	±0.3nH	8	100	11	23	30	36	42	6000	11000	0.12	0.06	300	700	0.50 ±0.05 (0.02 ±0.002)	10,000
L0402C2N0SRMST	2	±0.3nH	8	100	11	21	27	34	39	6000	10500	0.12	0.06	300	700	0.50 ±0.05 (0.02 ±0.002)	10,000
L0402C2N2SRMST	2.2	±0.3nH	8	100	10	18	25	31	36	6000	10000	0.13	0.07	300	700	0.50 ±0.05 (0.02 ±0.002)	10,000
L0402C2N4SRMST	2.4	±0.3nH	8	100	10	18	24	31	35	6000	9500	0.13	0.07	300	650	0.50 ±0.05 (0.02 ±0.002)	10,000
L0402C2N7SRMST	2.7	±0.3nH	8	100	10	18	24	31	34	6000	9000	0.13	0.08	300	650	0.50 ±0.05 (0.02 ±0.002)	10,000
L0402C3N0SRMST	3	±0.3nH	8	100	10	18	24	31	35	6000	8500	0.16	0.09	300	600	0.50 ±0.05 (0.02 ±0.002)	10,000
L0402C3N3SRMST	3.3	±0.3nH	8	100	10	18	24	31	35	6000	8000	0.16	0.10	300	550	0.50 ±0.05 (0.02 ±0.002)	10,000
L0402C3N6SRMST	3.6	±0.3nH	8	100	10	18	24	31	35	5000	7500	0.20	0.11	300	500	0.50 ±0.05 (0.02 ±0.002)	10,000
L0402C3N9SRMST	3.9	±0.3nH	8	100	10	18	24	31	35	4000	7000	0.21	0.12	300	500	0.50 ±0.05 (0.02 ±0.002)	10,000
L0402C4N3SRMST	4.3	±0.3nH	8	100	10	18	24	31	35	4000	6500	0.20	0.12	300	500	0.50 ±0.05 (0.02 ±0.002)	10,000
L0402C4N7SRMST	4.7	±0.3nH	8	100	10	18	24	31	34	4000	6000	0.21	0.12	300	500	0.50 ±0.05 (0.02 ±0.002)	10,000
L0402C5N1SRMST	5.1	±0.3nH	8	100	10	18	24	31	34	4000	5800	0.21	0.13	300	450	0.50 ±0.05 (0.02 ±0.002)	10,000
L0402C5N6SRMST	5.6	±0.3nH	8	100	10	18	24	30	35	4000	5700	0.23	0.15	300	430	0.50 ±0.05 (0.02 ±0.002)	10,000
L0402C6N2SRMST	6.2	±0.3nH	8	100	10	18	24	30	34	3900	5600	0.25	0.16	300	430	0.50 ±0.05 (0.02 ±0.002)	10,000
L0402C6N8JRMST	6.8	±5%	8	100	10	18	23	29	32	3900	5500	0.25	0.17	300	430	0.50 ±0.05 (0.02 ±0.002)	10,000
L0402C7N5JRMST	7.5	±5%	8	100	10	18	23	29	32	3700	5200	0.25	0.18	300	400	0.50 ±0.05 (0.02 ±0.002)	10,000
L0402C8N2JRMST	8.2	±5%	8	100	10	18	23	29	31	3600	4900	0.28	0.21	300	380	0.50 ±0.05 (0.02 ±0.002)	10,000
L0402C9N1JRMST	9.1	±5%	8	100	10	18	23	29	31	3400	4500	0.30	0.22	300	360	0.50 ±0.05 (0.02 ±0.002)	10,000
L0402C10NJRMST	10	±5%	8	100	10	18	23	29	31	3200	4300	0.31	0.23	300	340	0.50 ±0.05 (0.02 ±0.002)	10,000
L0402C12NJRMST	12	±5%	8	100	11	18	23	29	31	2700	3900	0.40	0.28	300	330	0.50 ±0.05 (0.02 ±0.002)	10,000
L0402C15NJRMST	15	±5%	8	100	11	18	23	28	30	2300	3500	0.46	0.31	300	320	0.50 ±0.05 (0.02 ±0.002)	10,000
L0402C18NJRMST	18	±5%	8	100	11	18	23	28	30	2100	3100	0.55	0.35	300	310	0.50 ±0.05 (0.02 ±0.002)	10,000
L0402C22NJRMST	22	±5%	8	100	11	17	22	26	27	1900	2800	0.60	0.42	300	300	0.50 ±0.05 (0.02 ±0.002)	10,000
L0402C27NJRMST	27	±5%	8	100	11	17	21	25	26	1600	2300	0.70	0.47	300	300	0.50 ±0.05 (0.02 ±0.002)	10,000
L0402C33NJRMST	33	±5%	8	100	11	16	20	23	22	1300	1900	0.80	0.50	200	250	0.50 ±0.05 (0.02 ±0.002)	10,000
L0402C39NJRMST	39	±5%	8	100	11	16	20	23	21	1200	1700	0.90	0.52	200	250	0.50 ±0.05 (0.02 ±0.002)	10,000
L0402C47NJRMST	47	±5%	8	100	11	16	19	21	18	1000	1500	1.00	0.58	200	230	0.50 ±0.05 (0.02 ±0.002)	10,000
L0402C56NJRMST	56	±5%	8	100	11	16	18	18	16	750	1300	1.00	0.61	200	220	0.50 ±0.05 (0.02 ±0.002)	10,000
L0402C68NJRMST	68	±5%	8	100	11	15	17	18	11	750	1200	1.20	0.70	180	200	0.50 ±0.05 (0.02 ±0.002)	10,000
L0402C82NJRMST	82	±5%	8	100	10	14	16	15	6	600	1100	1.30	0.81	150	200	0.50 ±0.05 (0.02 ±0.002)	10,000
L0402CR10JRMST	100	±5%	8	100	10	14	14	12	-	600	1000	1.50	0.94	150	200	0.50 ±0.05 (0.02 ±0.002)	10,000
L0402CR12JRMST	120	±5%	8	100	10	12	10	-	-	600	800	1.60	1.10	150	200	0.50 ±0.05 (0.02 ±0.002)	10,000

0603 Case Size Multilayer Chip Inductors for High Frequency (L-RMS Series)

Ordering Code	Inductance (nH)	Inductance Tolerance	Q min.	Measuring Frequency (MHz)	Typical Q					Self-resonant Frequency (MHz)		DC Resistance (Ω)		Maximum Rated Current (mA)	Thickness mm (inches)	Tape & Reel Packaging Quantity
					Frequency (MHz)					min.	typ.	max.	typ.			
					100	300	500	800	1000							
L0603C1N0SRMST	1.0	±0.3nH	8	100	14	30	40	70	90	10000	>13000	0.05	0.015	300	0.8 ±0.15 (0.031 ±0.006)	4,000
L0603C1N2SRMST	1.2	±0.3nH	8	100	14	30	40	70	90	10000	>13000	0.05	0.015	300	0.8 ±0.15 (0.031 ±0.006)	4,000
L0603C1N5SRMST	1.5	±0.3nH	8	100	14	26	34	47	50	6000	>13000	0.10	0.03	300	0.8 ±0.15 (0.031 ±0.006)	4,000
L0603C1N8SRMST	1.8	±0.3nH	8	100	10	18	24	30	34	6000	>13000	0.10	0.06	300	0.8 ±0.15 (0.031 ±0.006)	4,000
L0603C2N2SRMST	2.2	±0.3nH	8	100	12	22	29	37	40	6000	12000	0.10	0.06	300	0.8 ±0.15 (0.031 ±0.006)	4,000
L0603C2N7SRMST	2.7	±0.3nH	10	100	13	24	32	41	45	6000	11000	0.10	0.06	300	0.8 ±0.15 (0.031 ±0.006)	4,000
L0603C3N3SRMST	3.3	±0.3nH	10	100	14	25	33	42	47	6000	9000	0.12	0.06	300	0.8 ±0.15 (0.031 ±0.006)	4,000
L0603C3N9SRMST	3.9	±0.3nH	10	100	13	25	33	42	46	6000	8000	0.14	0.07	300	0.8 ±0.15 (0.031 ±0.006)	4,000
L0603C4N7SRMST	4.7	±0.3nH	10	100	13	25	33	42	47	4000	6500	0.16	0.08	300	0.8 ±0.15 (0.031 ±0.006)	4,000
L0603C5N6SRMST	5.6	±0.3nH	10	100	14	25	33	42	46	4000	5800	0.18	0.09	300	0.8 ±0.15 (0.031 ±0.006)	4,000
L0603C6N8JRMST	6.8	±5%	10	100	14	25	33	43	47	4000	5600	0.22	0.11	300	0.8 ±0.15 (0.031 ±0.006)	4,000
L0603C8N2JRMST	8.2	±5%	10	100	14	26	34	44	48	3500	5200	0.24	0.13	300	0.8 ±0.15 (0.031 ±0.006)	4,000
L0603C10NJRMST	10	±5%	12	100	14	26	34	43	47	3400	4600	0.26	0.16	300	0.8 ±0.15 (0.031 ±0.006)	4,000
L0603C12NJRMST	12	±5%	12	100	14	27	35	45	49	2600	4000	0.28	0.17	300	0.8 ±0.15 (0.031 ±0.006)	4,000
L0603C15NJRMST	15	±5%	12	100	15	28	37	46	51	2300	3400	0.32	0.20	300	0.8 ±0.15 (0.031 ±0.006)	4,000
L0603C18NJRMST	18	±5%	12	100	15	27	36	44	48	2000	3000	0.35	0.21	300	0.8 ±0.15 (0.031 ±0.006)	4,000
L0603C22NJRMST	22	±5%	12	100	16	28	36	44	47	1600	2900	0.40	0.25	300	0.8 ±0.15 (0.031 ±0.006)	4,000
L0603C27NJRMST	27	±5%	12	100	16	29	37	45	46	1400	2200	0.45	0.28	300	0.8 ±0.15 (0.031 ±0.006)	4,000
L0603C33NJRMST	33	±5%	12	100	17	31	40	46	47	1200	1800	0.55	0.35	300	0.8 ±0.15 (0.031 ±0.006)	4,000
L0603C39NJRMST	39	±5%	12	100	18	31	39	44	44	1100	1600	0.60	0.38	300	0.8 ±0.15 (0.031 ±0.006)	4,000
L0603C47NJRMST	47	±5%	12	100	17	28	34	35	34	900	1600	0.70	0.45	300	0.8 ±0.15 (0.031 ±0.006)	4,000
L0603C56NJRMST	56	±5%	12	100	17	28	34	34	31	900	1400	0.75	0.50	300	0.8 ±0.15 (0.031 ±0.006)	4,000
L0603C68NJRMST	68	±5%	12	100	18	29	34	30	22	700	1200	0.85	0.55	300	0.8 ±0.15 (0.031 ±0.006)	4,000
L0603C82NJRMST	82	±5%	12	100	18	28	33	27	-	600	1100	0.95	0.60	300	0.8 ±0.15 (0.031 ±0.006)	4,000
L0603CR10JRMST	100	±5%	12	100	18	27	28	16	-	600	1000	1.00	0.65	300	0.8 ±0.15 (0.031 ±0.006)	4,000
L0603CR12JRMST	120	±5%	8	50	16	24	23	-	-	500	800	1.20	0.68	300	0.8 ±0.15 (0.031 ±0.006)	4,000
L0603CR15JRMST	150	±5%	8	50	13	19	16	-	-	500	800	1.20	0.73	300	0.8 ±0.15 (0.031 ±0.006)	4,000
L0603CR18JRMST	180	±5%	8	50	13	18	12	-	-	400	700	1.30	0.85	300	0.8 ±0.15 (0.031 ±0.006)	4,000
L0603CR22JRMST	220	±5%	8	50	12	16	-	-	-	400	600	1.50	0.95	300	0.8 ±0.15 (0.031 ±0.006)	4,000
L0603CR27JRMST	270	±5%	8	50	14	15	-	-	-	400	550	1.90	1.34	150	0.8 ±0.15 (0.031 ±0.006)	4,000
L0603CR33JRMST	330	±5%	8	50	14	-	-	-	-	350	480	2.10	1.53	150	0.8 ±0.15 (0.031 ±0.006)	4,000
L0603CR39JRMST	390	±5%	8	50	13	-	-	-	-	350	410	2.30	1.72	150	0.8 ±0.15 (0.031 ±0.006)	4,000
L0603CR47JRMST	470	±5%	8	50	13	-	-	-	-	300	360	2.60	2.04	150	0.8 ±0.15 (0.031 ±0.006)	4,000

Multilayer Chip Inductors - High Frequency - L-RMS Series

0805 Case Size Multilayer Chip Inductors for High Frequency (L-RMS Series)

Ordering Code	Inductance (nH)	Inductance Tolerance	Q min.	Measuring Frequency (MHz)	Typical Q					Self-resonant Frequency (MHz)		DC Resistance (Ω)		Maximum Rated Current (mA)	Thickness mm (inches)	Tape & Reel Packaging Quantity
					Frequency (MHz)					min.	typ.	max.	typ.			
					100	300	500	800	1000							
L0805C1N5SRMST	1.5	± 0.3 nH	10	100	21	39	57	61	68	4000	>6000	0.10	0.02	300	0.85 ± 0.2 (0.033 ± 0.008)	4,000
L0805C1N8SRMST	1.8	± 0.3 nH	10	100	18	35	49	55	59	4000	>6000	0.10	0.02	300	0.85 ± 0.2 (0.033 ± 0.008)	4,000
L0805C2N2SRMST	2.2	± 0.3 nH	10	100	18	33	46	53	58	4000	>6000	0.10	0.03	300	0.85 ± 0.2 (0.033 ± 0.008)	4,000
L0805C2N7SRMST	2.7	± 0.3 nH	12	100	19	36	50	56	60	4000	>6000	0.10	0.03	300	0.85 ± 0.2 (0.033 ± 0.008)	4,000
L0805C3N3SRMST	3.3	± 0.3 nH	12	100	16	29	40	47	51	4000	>6000	0.13	0.04	300	0.85 ± 0.2 (0.033 ± 0.008)	4,000
L0805C3N9SRMST	3.9	± 0.3 nH	12	100	18	33	46	54	60	4000	>6000	0.15	0.05	300	0.85 ± 0.2 (0.033 ± 0.008)	4,000
L0805C4N7SRMST	4.7	± 0.3 nH	12	100	18	34	46	55	60	3500	>6000	0.20	0.05	300	0.85 ± 0.2 (0.033 ± 0.008)	4,000
L0805C5N6SRMST	5.6	± 0.3 nH	15	100	20	38	51	60	66	3200	5400	0.23	0.05	300	0.85 ± 0.2 (0.033 ± 0.008)	4,000
L0805C6N8JRMST	6.8	$\pm 5\%$	15	100	20	39	52	63	69	2800	4200	0.25	0.06	300	0.85 ± 0.2 (0.033 ± 0.008)	4,000
L0805C8N2JRMST	8.2	$\pm 5\%$	15	100	21	40	54	63	70	2400	3700	0.28	0.07	300	0.85 ± 0.2 (0.033 ± 0.008)	4,000
L0805C10NJRMST	10	$\pm 5\%$	15	100	20	38	51	60	67	2100	3100	0.30	0.09	300	0.85 ± 0.2 (0.033 ± 0.008)	4,000
L0805C12NJRMST	12	$\pm 5\%$	15	100	21	39	52	60	67	1900	3000	0.35	0.10	300	0.85 ± 0.2 (0.033 ± 0.008)	4,000
L0805C15NJRMST	15	$\pm 5\%$	15	100	22	42	55	63	72	1600	2600	0.40	0.11	300	0.85 ± 0.2 (0.033 ± 0.008)	4,000
L0805C18NJRMST	18	$\pm 5\%$	15	100	24	44	57	63	72	1500	2300	0.45	0.13	300	0.85 ± 0.2 (0.033 ± 0.008)	4,000
L0805C22NJRMST	22	$\pm 5\%$	18	100	23	43	55	60	69	1400	2100	0.50	0.16	300	0.85 ± 0.2 (0.033 ± 0.008)	4,000
L0805C27NJRMST	27	$\pm 5\%$	18	100	23	42	53	58	68	1300	1800	0.55	0.17	300	0.85 ± 0.2 (0.033 ± 0.008)	4,000
L0805C33NJRMST	33	$\pm 5\%$	18	100	24	43	54	55	60	1200	1700	0.60	0.19	300	0.85 ± 0.2 (0.033 ± 0.008)	4,000
L0805C39NJRMST	39	$\pm 5\%$	18	100	23	41	50	47	47	1000	1400	0.65	0.25	300	0.85 ± 0.2 (0.033 ± 0.008)	4,000
L0805C47NJRMST	47	$\pm 5\%$	18	100	23	41	49	43	41	900	1200	0.70	0.26	300	1.0 ± 0.2 -0.3 (0.039 ± 0.008 / -0.012)	3,000
L0805C56NJRMST	56	$\pm 5\%$	18	100	23	42	48	39	38	800	1100	0.75	0.28	300	1.0 ± 0.2 -0.3 (0.039 ± 0.008 / -0.012)	3,000
L0805C68NJRMST	68	$\pm 5\%$	18	100	25	42	45	30	-	700	900	0.80	0.33	300	1.0 ± 0.2 -0.3 (0.039 ± 0.008 / -0.012)	3,000
L0805C82NJRMST	82	$\pm 5\%$	18	100	24	41	41	-	-	600	800	0.90	0.37	300	1.0 ± 0.2 -0.3 (0.039 ± 0.008 / -0.012)	3,000
L0805CR10JRMST	100	$\pm 5\%$	18	100	23	37	37	-	-	600	800	0.90	0.40	300	1.0 ± 0.2 -0.3 (0.039 ± 0.008 / -0.012)	3,000
L0805CR12JRMST	120	$\pm 5\%$	13	50	22	33	29	-	-	500	700	0.95	0.43	300	1.0 ± 0.2 -0.3 (0.039 ± 0.008 / -0.012)	3,000
L0805CR15JRMST	150	$\pm 5\%$	13	50	22	34	26	-	-	500	700	1.00	0.46	300	1.0 ± 0.2 -0.3 (0.039 ± 0.008 / -0.012)	3,000
L0805CR18JRMST	180	$\pm 5\%$	13	50	23	34	20	-	-	400	600	1.10	0.50	300	1.0 ± 0.2 -0.3 (0.039 ± 0.008 / -0.012)	3,000
L0805CR22JRMST	220	$\pm 5\%$	12	50	20	23	-	-	-	350	550	1.20	0.75	300	1.0 ± 0.2 -0.3 (0.039 ± 0.008 / -0.012)	3,000
L0805CR27JRMST	270	$\pm 5\%$	12	50	20	19	-	-	-	300	480	1.30	0.85	300	1.0 ± 0.2 -0.3 (0.039 ± 0.008 / -0.012)	3,000
L0805CR33JRMST	330	$\pm 5\%$	12	50	22	15	-	-	-	250	400	1.40	0.90	300	1.0 ± 0.2 -0.3 (0.039 ± 0.008 / -0.012)	3,000
L0805CR39JRMST	390	$\pm 5\%$	10	50	17	12	-	-	-	250	400	1.30	0.85	300	1.0 ± 0.2 -0.3 (0.039 ± 0.008 / -0.012)	3,000
L0805CR47JRMST	470	$\pm 5\%$	10	50	17	-	-	-	-	200	350	1.50	0.95	300	1.0 ± 0.2 -0.3 (0.039 ± 0.008 / -0.012)	3,000

Multilayer Chip Inductors - L-SMS/L-PMS/L-DMI Series

Features:

- Internal printed coil structure creates a closed magnetic circuit which acts as a magnetic shield eliminating crosstalk, thus permitting higher mounting densities.
- Multilayer block structure yields higher reliability
- The smallest mH inductors in the world (SMS 0402 Series)
- Low DC power dissipation due to Low Rdc with High Aspect Ratio internal conductor that stands on the Green Sheet and Printing technologies (DMI Series)

Operating Temperature:

- -40°C to +85°C

Applications:

- Any general circuit in portable equipment in which a compact size and high mounting densities are required (SMS Series)
- Separation of analog and digital circuits (PMS Series)
- Prevents interference between PLL and other digital circuits (PMS Series)
- DC/DC convertor for mobile equipment, cellular phones, DSC and DVC (PMS Series)

Part Numbering Table

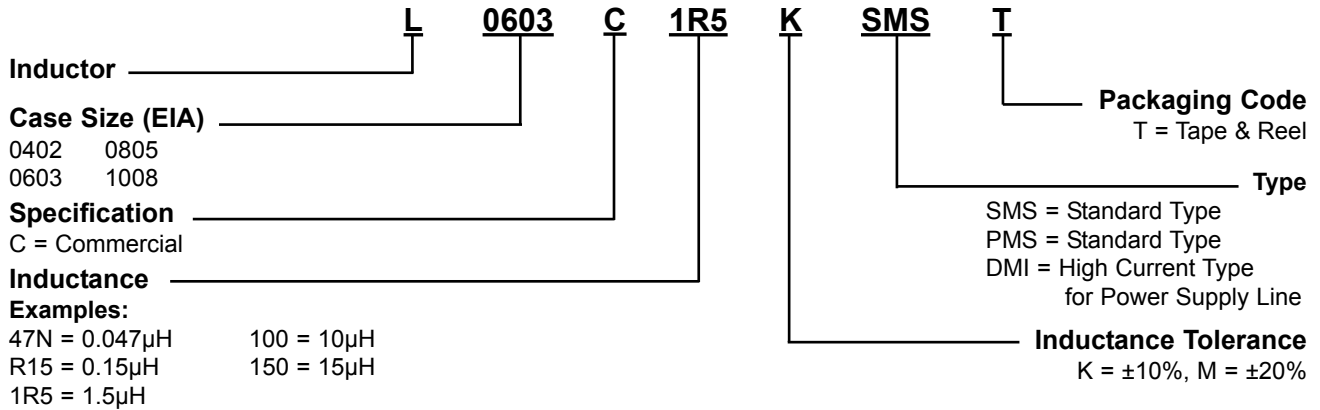

Dimension Table in millimeters (inches)

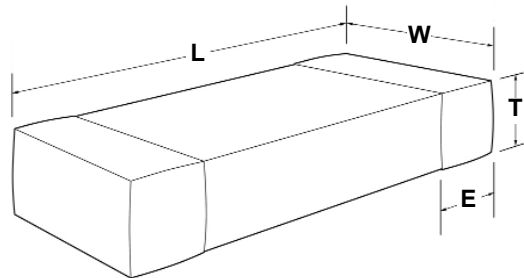

EIA Case Size	Metric Dim. Code	L Length (inches)	W Width (inches)	T Thickness Maximum (inches)	E (inches)
0402	1005	1.0 ±0.05 (0.039 ±0.002)	0.50 ±0.05 (0.020 ±0.002)	0.50 ±0.05 (0.020 ±0.002)	0.25 ±0.10 (0.010 ±0.004)
0603	1608	1.6 ±0.15 (0.063 ±0.006)	0.8 ±0.15 (0.031 ±0.006)	0.8 ±0.15 (0.031 ±0.006)	0.3 ±0.2 (0.012 ±0.008)
0805	2125	2.0 +0.3/-0.1 (0.079 _0.012/-0.004)	1.25 ±0.2 (0.049 ±0.008)	0.85 ±0.2 1.25 ±0.2 (0.033 ±0.008) (0.049 ±0.008)	0.5 ±0.2 (0.02 ±0.008)
1008	2520	2.5 ± 0.2 (0.098 ± 0.008)	2.0 ± 0.2 (0.079 ± 0.008)	1.0 Max. (0.039)	0.5 ± 0.3 (0.02 ± 0.012)

0402 Case Size Multilayer Chip Inductors (L-SMS Series)

Ordering Code	Inductance (μH)	Inductance Tolerance	Q min.	Minimum Self Resonant Frequency (MHz)	Maximum DC Resistance (Ω)	Maximum Rated Current (mA)	Measuring Frequency (MHz)	Thickness mm (inches)	Tape & Reel Packaging Quantity
L0402CR12(_)SMST	0.12	K±10%. M±20%	10	180	0.70	25	25	0.5 ±0.05 (0.02 ±0.002)	10,000
L0402CR15(_)SMST	0.15	K±10%. M±20%	10	165	0.90	25	25	0.5 ±0.05 (0.02 ±0.002)	10,000
L0402CR18(_)SMST	0.18	K±10%. M±20%	10	150	1.10	25	25	0.5 ±0.05 (0.02 ±0.002)	10,000
L0402CR22(_)SMST	0.22	K±10%. M±20%	10	135	1.30	25	25	0.5 ±0.05 (0.02 ±0.002)	10,000
L0402CR27(_)SMST	0.27	K±10%. M±20%	10	120	1.50	25	25	0.5 ±0.05 (0.02 ±0.002)	10,000
L0402CR33(_)SMST	0.33	K±10%. M±20%	10	105	1.70	25	25	0.5 ±0.05 (0.02 ±0.002)	10,000
L0402CR39(_)SMST	0.39	K±10%. M±20%	20	85	0.60	10	10	0.5 ±0.05 (0.02 ±0.002)	10,000
L0402CR47(_)SMST	0.47	K±10%. M±20%	20	80	0.70	10	10	0.5 ±0.05 (0.02 ±0.002)	10,000
L0402CR56(_)SMST	0.56	K±10%. M±20%	20	75	0.80	10	10	0.5 ±0.05 (0.02 ±0.002)	10,000
L0402CR68(_)SMST	0.68	K±10%. M±20%	20	70	0.90	10	10	0.5 ±0.05 (0.02 ±0.002)	10,000
L0402CR82(_)SMST	0.82	K±10%. M±20%	20	65	1.00	10	10	0.5 ±0.05 (0.02 ±0.002)	10,000
L0402C1R0(_)SMST	1.0	K±10%. M±20%	20	60	1.10	10	10	0.5 ±0.05 (0.02 ±0.002)	10,000
L0402C1R2(_)SMST	1.2	K±10%. M±20%	20	55	1.25	10	10	0.5 ±0.05 (0.02 ±0.002)	10,000
L0402C1R5(_)SMST	1.5	K±10%. M±20%	20	50	1.40	10	10	0.5 ±0.05 (0.02 ±0.002)	10,000
L0402C1R8(_)SMST	1.8	K±10%. M±20%	20	45	1.55	10	10	0.5 ±0.05 (0.02 ±0.002)	10,000
L0402C2R2(_)SMST	2.2	K±10%. M±20%	20	40	1.70	10	10	0.5 ±0.05 (0.02 ±0.002)	10,000

(_) - Insert Inductance Tolerance Code (K or M)

0603 Case Size Multilayer Chip Inductors (L-SMS Series)

Ordering Code	Inductance (µH)	Inductance Tolerance	Q min.	Minimum Self Resonant Frequency (MHz)	Maximum DC Resistance (Ω)	Maximum Rated Current (mA)	Measuring Frequency (MHz)	Thickness mm (inches)	Tape & Reel Packaging Quantity
L0603C47NMSMST	0.047	±20%	10	260	0.30	50	50	0.8 ±0.15 (0.031 ±0.006)	4,000
L0603C68NMSMST	0.068	±20%	10	250	0.30	50	50	0.8 ±0.15 (0.031 ±0.006)	4,000
L0603C82NMSMST	0.082	±20%	10	245	0.30	50	50	0.8 ±0.15 (0.031 ±0.006)	4,000
L0603CR10()SMST	0.10	K±10%, M±20%	15	240	0.50	50	25	0.8 ±0.15 (0.031 ±0.006)	4,000
L0603CR12()SMST	0.12	K±10%, M±20%	15	205	0.50	50	25	0.8 ±0.15 (0.031 ±0.006)	4,000
L0603CR15()SMST	0.15	K±10%, M±20%	15	180	0.60	50	25	0.8 ±0.15 (0.031 ±0.006)	4,000
L0603CR18()SMST	0.18	K±10%, M±20%	15	165	0.60	50	25	0.8 ±0.15 (0.031 ±0.006)	4,000
L0603CR22()SMST	0.22	K±10%, M±20%	15	150	0.80	50	25	0.8 ±0.15 (0.031 ±0.006)	4,000
L0603CR27()SMST	0.27	K±10%, M±20%	15	136	0.80	50	25	0.8 ±0.15 (0.031 ±0.006)	4,000
L0603CR33()SMST	0.33	K±10%, M±20%	15	125	0.85	35	25	0.8 ±0.15 (0.031 ±0.006)	4,000
L0603CR39()SMST	0.39	K±10%, M±20%	15	110	1.00	35	25	0.8 ±0.15 (0.031 ±0.006)	4,000
L0603CR47()SMST	0.47	K±10%, M±20%	15	105	1.35	35	25	0.8 ±0.15 (0.031 ±0.006)	4,000
L0603CR56()SMST	0.56	K±10%, M±20%	15	95	1.55	35	25	0.8 ±0.15 (0.031 ±0.006)	4,000
L0603CR68()SMST	0.68	K±10%, M±20%	15	80	1.70	35	25	0.8 ±0.15 (0.031 ±0.006)	4,000
L0603CR82()SMST	0.82	K±10%, M±20%	15	75	2.10	35	25	0.8 ±0.15 (0.031 ±0.006)	4,000
L0603C1R0()SMST	1.0	K±10%, M±20%	35	70	0.60	25	10	0.8 ±0.15 (0.031 ±0.006)	4,000
L0603C1R2()SMST	1.2	K±10%, M±20%	35	60	0.80	25	10	0.8 ±0.15 (0.031 ±0.006)	4,000
L0603C1R5()SMST	1.5	K±10%, M±20%	35	55	0.80	25	10	0.8 ±0.15 (0.031 ±0.006)	4,000
L0603C1R8()SMST	1.8	K±10%, M±20%	35	50	0.95	25	10	0.8 ±0.15 (0.031 ±0.006)	4,000
L0603C2R2()SMST	2.2	K±10%, M±20%	35	45	1.15	15	10	0.8 ±0.15 (0.031 ±0.006)	4,000
L0603C2R7()SMST	2.7	K±10%, M±20%	35	40	1.35	15	10	0.8 ±0.15 (0.031 ±0.006)	4,000
L0603C3R3()SMST	3.3	K±10%, M±20%	35	38	1.55	15	10	0.8 ±0.15 (0.031 ±0.006)	4,000
L0603C3R9()SMST	3.9	K±10%, M±20%	35	36	1.70	15	10	0.8 ±0.15 (0.031 ±0.006)	4,000
L0603C4R7()SMST	4.7	K±10%, M±20%	35	33	2.10	15	10	0.8 ±0.15 (0.031 ±0.006)	4,000
L0603C5R6()SMST	5.6	K±10%, M±20%	35	22	1.55	5	4	0.8 ±0.15 (0.031 ±0.006)	4,000
L0603C6R8()SMST	6.8	K±10%, M±20%	35	20	1.70	5	4	0.8 ±0.15 (0.031 ±0.006)	4,000
L0603C8R2()SMST	8.2	K±10%, M±20%	35	18	2.10	5	4	0.8 ±0.15 (0.031 ±0.006)	4,000
L0603C100()SMST	10	K±10%, M±20%	35	17	2.55	5	2	0.8 ±0.15 (0.031 ±0.006)	4,000
L0603C120()SMST	12	K±10%, M±20%	35	15	2.75	5	2	0.8 ±0.15 (0.031 ±0.006)	4,000
L0603C150MSMST	15	±20%	20	14	1.70	1	1	0.8 ±0.15 (0.031 ±0.006)	4,000
L0603C180MSMST	18	±20%	20	13	1.85	1	1	0.8 ±0.15 (0.031 ±0.006)	4,000
L0603C220MSMST	22	±20%	20	11	2.10	1	1	0.8 ±0.15 (0.031 ±0.006)	4,000
L0603C270MSMST	27	±20%	20	10	2.75	1	1	0.8 ±0.15 (0.031 ±0.006)	4,000
L0603C330MSMST	33	±20%	20	9	2.95	1	1	0.8 ±0.15 (0.031 ±0.006)	4,000

() - Insert Inductance Tolerance Code (K or M)

0805 Case Size Multilayer Chip Inductors (L-SMS Series)

Ordering Code	Inductance (µH)	Inductance Tolerance	Q min.	Minimum Self Resonant Frequency (MHz)	Maximum DC Resistance (Ω)	Maximum Rated Current (mA)	Measuring Frequency (MHz)	Thickness mm (inches)	Tape & Reel Packaging Quantity
L0805C47NMSMST	0.047	±20%	15	320	0.20	300	50	0.85 ±0.2 (0.033 ±0.008)	2,000
L0805C68NMSMST	0.068	±20%	15	280	0.20	300	50	0.85 ±0.2 (0.033 ±0.008)	4,000
L0805C82NMSMST	0.082	±20%	15	255	0.20	300	50	0.85 ±0.2 (0.033 ±0.008)	4,000
L0805CR10()SMST	0.10	K±10%, M±20%	20	235	0.30	250	25	0.85 ±0.2 (0.033 ±0.008)	4,000
L0805CR12()SMST	0.12	K±10%, M±20%	20	220	0.30	250	25	0.85 ±0.2 (0.033 ±0.008)	4,000
L0805CR15()SMST	0.15	K±10%, M±20%	20	200	0.40	250	25	0.85 ±0.2 (0.033 ±0.008)	4,000
L0805CR18()SMST	0.18	K±10%, M±20%	20	185	0.40	250	25	0.85 ±0.2 (0.033 ±0.008)	4,000
L0805CR22()SMST	0.22	K±10%, M±20%	20	170	0.50	250	25	0.85 ±0.2 (0.033 ±0.008)	4,000
L0805CR27()SMST	0.27	K±10%, M±20%	20	150	0.50	250	25	0.85 ±0.2 (0.033 ±0.008)	4,000
L0805CR33()SMST	0.33	K±10%, M±20%	20	145	0.55	250	25	0.85 ±0.2 (0.033 ±0.008)	4,000
L0805CR39()SMST	0.39	K±10%, M±20%	25	135	0.65	200	25	0.85 ±0.2 (0.033 ±0.008)	4,000
L0805CR47()SMST	0.47	K±10%, M±20%	25	125	0.65	200	25	1.25 ±0.2 (0.049 ±0.008)	2,000
L0805CR56()SMST	0.56	K±10%, M±20%	25	115	0.75	150	25	1.25 ±0.2 (0.049 ±0.008)	2,000
L0805CR68()SMST	0.68	K±10%, M±20%	25	105	0.80	150	25	1.25 ±0.2 (0.049 ±0.008)	2,000
L0805CR82()SMST	0.82	K±10%, M±20%	25	100	1.00	150	25	1.25 ±0.2 (0.049 ±0.008)	2,000
L0805C1R0()SMST	1.0	K±10%, M±20%	45	75	0.40	50	10	0.85 ±0.2 (0.033 ±0.008)	4,000
L0805C1R2()SMST	1.2	K±10%, M±20%	45	65	0.50	50	10	0.85 ±0.2 (0.033 ±0.008)	4,000
L0805C1R5()SMST	1.5	K±10%, M±20%	45	60	0.50	50	10	0.85 ±0.2 (0.033 ±0.008)	4,000
L0805C1R8()SMST	1.8	K±10%, M±20%	45	55	0.60	50	10	0.85 ±0.2 (0.033 ±0.008)	4,000
L0805C2R2()SMST	2.2	K±10%, M±20%	45	50	0.65	30	10	0.85 ±0.2 (0.033 ±0.008)	4,000
L0805C2R7()SMST	2.7	K±10%, M±20%	45	45	0.75	30	10	1.25 ±0.2 (0.049 ±0.008)	2,000
L0805C3R3()SMST	3.3	K±10%, M±20%	45	41	0.80	30	10	1.25 ±0.2 (0.049 ±0.008)	2,000
L0805C3R9()SMST	3.9	K±10%, M±20%	45	38	0.90	30	10	1.25 ±0.2 (0.049 ±0.008)	2,000
L0805C4R7()SMST	4.7	K±10%, M±20%	45	35	1.00	30	10	1.25 ±0.2 (0.049 ±0.008)	2,000
L0805C5R6()SMST	5.6	K±10%, M±20%	50	32	0.90	15	4	1.25 ±0.2 (0.049 ±0.008)	2,000
L0805C6R8()SMST	6.8	K±10%, M±20%	50	29	1.00	15	4	1.25 ±0.2 (0.049 ±0.008)	2,000
L0805C8R2()SMST	8.2	K±10%, M±20%	50	26	1.10	15	4	1.25 ±0.2 (0.049 ±0.008)	2,000
L0805C100()SMST	10	K±10%, M±20%	50	24	1.15	15	2	1.25 ±0.2 (0.049 ±0.008)	2,000
L0805C120()SMST	12	K±10%, M±20%	50	22	1.25	15	2	1.25 ±0.2 (0.049 ±0.008)	2,000
L0805C150MSMST	15	±20%	30	19	0.80	5	1	1.25 ±0.2 (0.049 ±0.008)	2,000
L0805C180MSMST	18	±20%	30	18	0.90	5	1	1.25 ±0.2 (0.049 ±0.008)	2,000
L0805C220MSMST	22	±20%	30	16	1.10	5	1	1.25 ±0.2 (0.049 ±0.008)	2,000
L0805C270MSMST	27	±20%	30	14	1.15	5	1	1.25 ±0.2 (0.049 ±0.008)	2,000
L0805C330MSMST	33	±20%	30	13	1.25	5	0.4	1.25 ±0.2 (0.049 ±0.008)	2,000

() Insert Tolerance Code (K±10% or M±20%) listed to the right

0603 Case Size Multilayer Chip Inductors (L-PMS Series)

Ordering Code	Inductance (μH)	Inductance Tolerance	Minimum Inductance at 200mA (μH)	Maximum DC Resistance (Ω)	Maximum Rated Current (mA)	Measuring Frequency (MHz)	Thickness mm (inches)	Tape & Reel Packaging Quantity
L0603C4R7MPMST	4.7	±20%	20	0.45	60	4	0.80 ±0.15 (0.031 ±0.006)	4,000
L0603C100MPMST	10.0	±20%	20	0.85	50	2	0.80 ±0.15 (0.031 ±0.006)	4,000

0805 Case Size Multilayer Chip Inductors (L-PMS Series)

Ordering Code	Inductance (μH)	Inductance Tolerance	Q min.	Minimum Self Resonant Frequency (MHz)	Maximum DC Resistance (Ω)	Maximum Rated Current (mA)	Measuring Frequency (MHz)	Thickness mm (inches)	Tape & Reel Packaging Quantity
L0805CR10MPMST	0.10	±20%	15	235	0.16	500	25	0.85 ±0.2 (0.033 ±0.008)	4,000
L0805CR15MPMST	0.15	±20%	15	200	0.20	500	25	0.85 ±0.2 (0.033 ±0.008)	4,000
L0805CR22MPMST	0.22	±20%	15	170	0.23	400	25	0.85 ±0.2 (0.033 ±0.008)	4,000
L0805CR33MPMST	0.33	±20%	15	145	0.28	400	25	0.85 ±0.2 (0.033 ±0.008)	4,000
L0805CR47MPMST	0.47	±20%	15	125	0.32	400	25	1.25 ±0.2 (0.049 ±0.008)	2,000
L0805CR68MPMST	0.68	±20%	15	105	0.45	300	25	1.25 ±0.2 (0.049 ±0.008)	2,000
L0805C1R0MPMST	1.0	±20%	20	75	0.26	220	10	0.85 ±0.2 (0.033 ±0.008)	4,000
L0805C1R5MPMST	1.5	±20%	20	60	0.28	170	10	0.85 ±0.2 (0.033 ±0.008)	4,000
L0805C2R2MPMST	2.2	±20%	20	50	0.35	150	10	0.85 ±0.2 (0.033 ±0.008)	4,000
L0805C3R3MPMST	3.3	±20%	20	41	0.43	130	10	1.25 ±0.2 (0.049 ±0.008)	2,000
L0805C4R7MPMST	4.7	±20%	20	35	0.48	80	10	1.25 ±0.2 (0.049 ±0.008)	2,000
L0805C6R8MPMST	6.8	±20%	20	29	0.52	70	4	1.25 ±0.2 (0.049 ±0.008)	2,000
L0805C100MPMST	10.0	±20%	20	24	0.65	60	2	1.25 ±0.2 (0.049 ±0.008)	2,000

1008 Case Size Multilayer Chip Inductors (L-DMI Series)

Ordering Code	Inductance (μH)	Inductance Tolerance	Minimum Inductance at 200mA (μH)	Maximum DC Resistance (Ω)	Maximum Rated Current (mA)	Measuring Frequency (MHz)	Thickness mm (inches)	Tape & Reel Packaging Quantity
L1008C2R2MDMIT	2.2	±20%	1.5	0.09	1300	1	1.0 max (0.039 max)	4,000
L1008C3R3MDMIT	3.3	±20%	2.0	0.10	1200	1	1.0 max (0.039 max)	4,000
L1008C4R7MDMIT	4.7	±20%	2.5	0.15	1100	1	1.0 max (0.039 max)	4,000

Low Profile SMD Inductors (L-DWD Series)

Features:

- Small and low profile inductor
- Corresponds to high current
- Simple and original magnetic shield structure
- Structure strong against shock-proof

Applications:

- For small DC/DC converter; cellular phones, HDD, HVC, DSC, and PDA LCD display

Operating Temperature:

- -25°C to +120°C (including self-generated heat)

Part Numbering Table

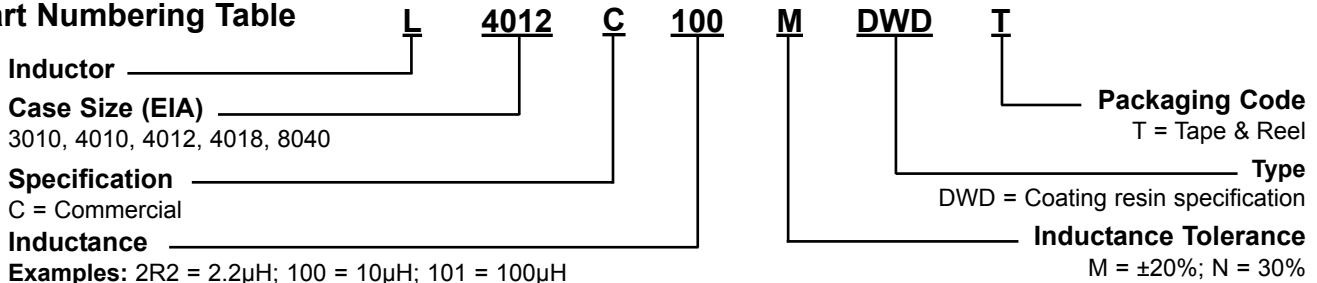

Dimension Table in millimeters (inches)

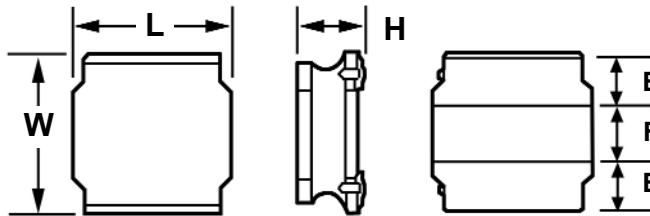

Metric Dim. Code	L Length (inches)	W Width (inches)	T Thickness Maximum (inches)	E (inches)	F
3010	3.0 ±0.1 (0.118 ±0.004)	3.0 ±0.1 (0.118 ±0.004)	1.0 max. (0.039 max.)	0.9 ±0.2 (0.035 ±0.008)	1.9 ±0.2 (0.075 ±0.008)
4010	4.0 ±0.2 (0.157 ±0.008)	4.0 ±0.2 (0.157 ±0.008)	1.0 max. (0.039 max.)	1.1 ±0.2 (0.043 ±0.008)	2.5 ±0.2 (0.098 ±0.008)
4012	4.0 ±0.2 (0.157 ±0.008)	4.0 ±0.2 (0.157 ±0.008)	1.2 max. (0.047 max.)	1.1 ±0.2 (0.043 ±0.008)	2.5 ±0.2 (0.098 ±0.008)
4018	4.0 ±0.2 (0.157 ±0.008)	4.0 ±0.2 (0.157 ±0.008)	1.8 max. (0.071 max.)	1.1 ±0.2 (0.043 ±0.008)	2.5 ±0.2 (0.098 ±0.008)
8040	8.0 ±0.2 (0.315 ±0.008)	8.0 ±0.2 (0.315 ±0.008)	4.2 max (0.165 max)	1.6 ±0.3 (0.063 ±0.012)	5.6 ±0.3 (0.220 ±0.012)

Dimensions 3.0mm x 3.0mm (L-DWD3010 Type, 1.0mm Max. Height)

Ordering Code	Inductance (µH)	Inductance Tolerance	Measuring Frequency (KHz)	Minimum Self-resonant Frequency (MHz)	Maximum DC Resistance (Ω) ±30%	Maximum Rated Current (mA)	Maximum Height (mm)	Tape & Reel Packaging Quantity
L3010C1R0NDWDT	1.0	±30%	100	126	0.065	1300	1.0	2,000
L3010C1R5NDWDT	1.5	±30%	100	98	0.08	1200	1.0	2,000
L3010C2R2MDWDT	2.2	±20%	100	82	0.095	1100	1.0	2,000
L3010C3R3MDWDT	3.3	±20%	100	63	0.14	870	1.0	2,000
L3010C4R7MDWDT	4.7	±20%	100	56	0.19	750	1.0	2,000
L3010C6R8MDWDT	6.8	±20%	100	46	0.30	610	1.0	2,000
L3010C100MDWDT	10	±20%	100	35	0.45	500	1.0	2,000
L3010C150MDWDT	15	±20%	100	30	0.74	400	1.0	2,000
L3010C220MDWDT	22	±20%	100	25	1.03	350	1.0	2,000
L3010C330MDWDT	33	±20%	100	20	1.55	260	1.0	2,000
L3010C470MDWDT	47	±20%	100	17	2.05	220	1.0	2,000

Dimensions 4.0mm x 4.0mm (L-DWD4010 Type, 1.0mm Max. Height)

Ordering code	Inductance (µH)	Inductance Tolerance	Measuring Frequency (KHz)	Minimum Self-resonant Frequency (MHz)	Maximum DC Resistance (Ω) ±30%	Maximum Rated Current (mA)	Maximum Height (mm)	Tape & Reel Packaging Quantity
L4010C1R0NDWDT	1.0	±30%	100	116	0.10	1050	1.0	5,000
L4010C2R2NDWDT	2.2	±30%	100	73	0.15	890	1.0	5,000
L4010C3R3MDWDT	3.3	±20%	100	58	0.18	820	1.0	5,000
L4010C4R7MDWDT	4.7	±20%	100	47	0.21	750	1.0	5,000
L4010C6R8MDWDT	6.8	±20%	100	38	0.30	620	1.0	5,000
L4010C100MDWDT	10	±20%	100	31	0.38	560	1.0	5,000
L4010C150MDWDT	15	±20%	100	24	0.51	470	1.0	5,000
L4010C220MDWDT	22	±20%	100	19	0.87	360	1.0	5,000
L4010C330MDWDT	33	±20%	100	15	1.54	280	1.0	5,000
L4010C470MDWDT	47	±20%	100	13	1.81	240	1.0	5,000

Dimensions 4.0mm x 4.0mm (L-DWD4012 Type, 1.2mm Max. Height)

Ordering Code	Inductance (µH)	Inductance Tolerance	Measuring Frequency (KHz)	Minimum Self-resonant Frequency (MHz)	Maximum DC Resistance (Ω) ±30%	Maximum Rated Current (mA)	Maximum Height (mm)	Tape & Reel Packaging Quantity
L4012C1R0NDWDT	1.0	±30%	100	131	0.06	1500	1.2	4,500
L4012C2R2MDWDT	2.2	±20%	100	66	0.09	1200	1.2	4,500
L4012C3R3MDWDT	3.3	±20%	100	50	0.13	980	1.2	4,500
L4012C4R7MDWDT	4.7	±20%	100	45	0.14	960	1.2	4,500
L4012C6R8MDWDT	6.8	±20%	100	35	0.18	840	1.2	4,500
L4012C100MDWDT	10	±20%	100	28	0.24	740	1.2	4,500
L4012C150MDWDT	15	±20%	100	23	0.40	560	1.2	4,500
L4012C220MDWDT	22	±20%	100	18	0.48	510	1.2	4,500
L4012C330MDWDT	33	±20%	100	15	0.81	400	1.2	4,500
L4012C470MDWDT	47	±20%	100	12	1.00	350	1.2	4,500

Dimensions 4.0mm x 4.0mm (L-DWD4018 Type, 1.8mm Max. Height)

Ordering Code	Inductance (µH)	Inductance Tolerance	Measuring Frequency (KHz)	Minimum Self-resonant Frequency (MHz)	Maximum DC Resistance (Ω) ±30%	Maximum Rated Current (mA)	Maximum Height (mm)	Tape & Reel Packaging Quantity
L4018C1R0NDWDT	1.0	±30%	100	80	0.03	1830	1.8	3,500
L4018C2R2MDWDT	2.2	±20%	100	52	0.06	1440	1.8	3,500
L4018C3R3MDWDT	3.3	±20%	100	44	0.07	1230	1.8	3,500
L4018C4R7MDWDT	4.7	±20%	100	34	0.09	1200	1.8	3,500
L4018C6R8MDWDT	6.8	±20%	100	29	0.11	1060	1.8	3,500
L4018C100MDWDT	10	±20%	100	24	0.18	840	1.8	3,500
L4018C150MDWDT	15	±20%	100	19	0.25	650	1.8	3,500
L4018C220MDWDT	22	±20%	100	16	0.36	590	1.8	3,500
L4018C330MDWDT	33	±20%	100	12	0.53	490	1.8	3,500
L4018C470MDWDT	47	±20%	100	10	0.65	420	1.8	3,500
L4018C680MDWDT	68	±20%	100	8.3	1.00	320	1.8	3,500
L4018C101MDWDT	100	±20%	100	6.5	1.50	280	1.8	3,500
L4018C221MDWDT	220	±20%	100	4	4.00	170	1.8	3,500

Dimensions 8.0mm x 8.0mm (L-DWD8040 Type, 4.2mm Max. Height)

Ordering Code	Inductance (µH)	Inductance Tolerance	Measuring Frequency (KHz)	Minimum Self-resonant Frequency (MHz)	Maximum DC Resistance (Ω) ±30%	Maximum Rated Current (mA)	Maximum Height (mm)	Tape & Reel Packaging Quantity
L8040C0R9NDWDT	0.9	±30%	100	85	0.006	7800	4.0	1,000
L8040C1R4NDWDT	1.4	±30%	100	63	0.007	7000	4.0	1,000
L8040C2R0NDWDT	2.0	±30%	100	50	0.009	6300	4.0	1,000
L8040C3R6NDWDT	3.6	±30%	100	34	0.015	4900	4.0	1,000
L8040C4R7NDWDT	4.7	±30%	100	30	0.018	4100	4.0	1,000
L8040C6R8NDWDT	6.8	±30%	100	24	0.025	3700	4.0	1,000
L8040C100MDWDT	10	±20%	100	22	0.034	3100	4.2	1,000
L8040C150MDWDT	15	±20%	100	16	0.050	2400	4.2	1,000
L8040C220MDWDT	22	±20%	100	13	0.066	2200	4.2	1,000
L8040C330MDWDT	33	±20%	100	12	0.100	1700	4.2	1,000
L8040C470MDWDT	47	±20%	100	8	0.150	1400	4.2	1,000
L8040C680MDWDT	68	±20%	100	7	0.230	1100	4.2	1,000
L8040C101MDWDT	100	±20%	100	6	0.290	1000	4.2	1,000

High Current Ferrite Chip Beads - Z-PWS/Z-PWZ Series

Features:

- Power supply units:
 - Large withstand voltage (allowable current up to 6A)
 - Resistant to high energy
 - High reliability
- There are several variations of the standard (Z-PWS) type (10th digit in part number)
 - "A" for broadband
 - "B" for upper MHz range applications
 - "G" for GHz range applications
- The Z-PWZ type is optimal for circuit designs which require impedance and large currents to combat radiated noise on power lines, etc.

Applications:

- Combats power line radiated and conducted noise
- Provides waveform correction of digital signals and high frequency noise countermeasures in various types of digital equipment
- Automotive
- Computer peripherals
- Differential transmission line on USB and similar products
- Mobile devices which require lower power consumption

Operating Temperature:

- -40°C to +125°C (includes self-generated heat)

Part Numbering Table

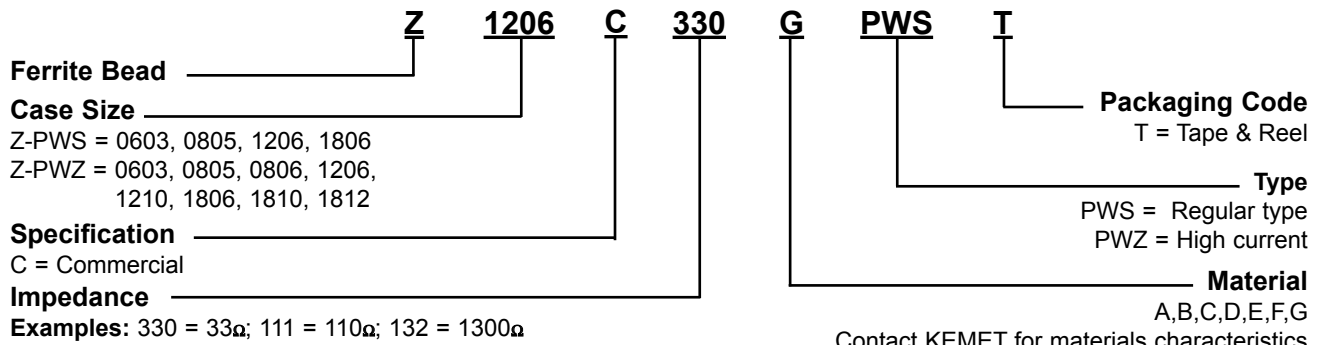

Dimension Table in millimeters (inches)

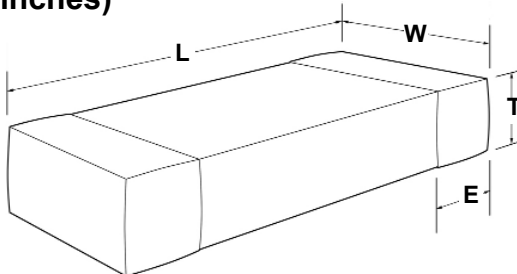

Characteristic Code	EIA Case Size	Metric Dim. Code	L Length (inches)	W Width (inches)	T Thickness Maximum (inches)	E (inches)
Z-PWS	0603	1608	1.6 ±0.2 (0.063 ±0.008)	0.8 ±0.2 (0.031 ±0.008)	0.8 ±0.2 (0.031 ±0.008)	0.3 ±0.2 (0.012 ±0.008)
	0805	2125	2.0 ±0.2 (0.079 ±0.008)	1.25 ±0.2 (0.049 ±0.008)	0.85 ±0.2 (0.02 ±0.002)	0.5 ±0.3 (0.020 ±0.012)
	1206	3216	3.2 ±0.3 (0.126 ±0.012)	1.6 ±0.2 (0.063 ±0.008)	1.6 ±0.2 (0.063 ±0.008)	0.5 ±0.3 (0.020 ±0.012)
	1806	4516	4.5 ±0.3 (0.177 ±0.012)	1.6 ±0.2 (0.063 ±0.008)	1.6 ±0.2 (0.063 ±0.008)	0.5 ±0.3 (0.020 ±0.012)
Z-PWZ	0603	1608	1.6 ±0.1 (0.063 ±0.004)	0.8 ±0.1 (0.031 ±0.004)	0.8 ±0.1 (0.031 ±0.004)	0.3 ±0.15 (0.012 ±0.006)
	0805	2012	2.0 ±0.2 (0.079 ±0.008)	1.25 ±0.2 (0.049 ±0.008)	0.85 ±0.2 (0.02 ±0.002)	0.5 ±0.3 (0.020 ±0.012)
	0806	2016	2.0 ±0.2 (0.079 ±0.008)	1.6 ±0.2 (0.063 ±0.008)	1.6 ±0.2 (0.063 ±0.008)	0.5 ±0.3 (0.020 ±0.012)
	1206	3216	3.2 ±0.3 (0.126 ±0.012)	1.6 ±0.2 (0.063 ±0.008)	1.6 ±0.2 (0.063 ±0.008)	0.5 ±0.3 (0.020 ±0.012)
	1210	3225	3.2 ±0.3 (0.126 ±0.012)	2.5 ±0.3 (0.098 ±0.012)	2.5 ±0.3 (0.098 ±0.012)	0.5 ±0.3 (0.020 ±0.012)
	1806	4516	4.5 ±0.3 (0.177 ±0.012)	1.6 ±0.2 (0.063 ±0.008)	1.6 ±0.2 (0.063 ±0.008)	0.5 ±0.3 (0.020 ±0.012)
	1810	4525	4.5 ±0.4 (0.177 ±0.016)	2.5 ±0.3 (0.098 ±0.012)	2.5 ±0.3 (0.098 ±0.012)	0.9 ±0.6 (0.035 ±0.024)
	1812	4532	4.5 ±0.4 (0.177 ±0.016)	3.2 ±0.3 (0.126 ±0.012)	3.2 ±0.3 (0.126 ±0.012)	0.9 ±0.6 (0.035 ±0.024)

0603 Case Size High Current Ferrite Chip Beads (Z-PWS Series)

Ordering Code	Impedance (Ω)	Measuring Frequency (MHz)	Maximum DC Resistance (Ω)	Maximum Rated Current (A)	Thickness mm (inches)	Tape & Reel Packaging Quantity
Z0603C230BPWST	23 ±30%	100	0.007	4	0.8 ±0.2 (0.031 ±0.008)	4,000
Z0603C280APWST	28 ±30%	100	0.007	4	0.8 ±0.2 (0.031 ±0.008)	4,000

0805 Case Size High Current Ferrite Chip Beads (Z-PWS Series)

Ordering Code	Impedance (Ω)	Measuring Frequency (MHz)	Maximum DC Resistance (Ω)	Maximum Rated Current (A)	Thickness mm (inches)	Tape & Reel Packaging Quantity
Z0805C8R0GPWST	8 ±30%	100	0.01	2	0.85 ±0.2 (0.033 ±0.008)	4,000
Z0805C210BPWST	21 ±30%	100	0.004	6	0.85 ±0.2 (0.033 ±0.008)	4,000
Z0805C250APWST	25 ±30%	100	0.004	6	0.85 ±0.2 (0.033 ±0.008)	4,000
Z0805C330BPWST	33 ±25%	100	0.008	4	0.85 ±0.2 (0.033 ±0.008)	4,000
Z0805C420APWST	42 ±25%	100	0.008	4	0.85 ±0.2 (0.033 ±0.008)	4,000

1206 Case Size High Current Ferrite Chip Beads (Z-PWS Series)

Ordering Code	Impedance (Ω)	Measuring Frequency (MHz)	Maximum DC Resistance (Ω)	Maximum Rated Current (A)	Thickness mm (inches)	Tape & Reel Packaging Quantity
Z1206C380BPWST	38 ±30%	100	0.005	6	1.1 ±0.2 (0.043 ±0.008)	2,000
Z1206C480APWST	48 ±30%	100	0.005	6	1.1 ±0.2 (0.043 ±0.008)	2,000
Z1206C600BPWST	60 ±25%	100	0.01	4	1.1 ±0.2 (0.043 ±0.008)	2,000
Z1206C800APWST	80 ±25%	100	0.01	4	1.1 ±0.2 (0.043 ±0.008)	2,000

1806 Case Size High Current Ferrite Chip Beads (Z-PWS Series)

Ordering Code	Impedance (Ω)	Measuring Frequency (MHz)	Maximum DC Resistance (Ω)	Maximum Rated Current (A)	Thickness mm (inches)	Tape & Reel Packaging Quantity
Z1806C560BPWST	56 ±30%	100	0.007	6	1.1 ±0.2 (0.043 ±0.008)	2,000
Z1806C900BPWST	90 ±25%	100	0.014	4	1.1 ±0.2 (0.043 ±0.008)	2,000
Z1806C720APWST	72 ±30%	100	0.007	6	1.1 ±0.2 (0.043 ±0.008)	2,000
Z1806C111APWST	110 ±25%	100	0.014	4	1.1 ±0.2 (0.043 ±0.008)	2,000

High Current Ferrite Chip Beads - Z-PWS, Z-PWZ Series

0603-1812 Case Size High Impedance Type Ferrite Chip Beads (Z-PWZ Series)

Ordering Code	EIA Case Size	Impedance (Ω)	Measuring Frequency (MHz)	Maximum DC Resistance (Ω)	Maximum Rated Current (A)	Thickness mm (inches)	Tape & Reel Packaging Quantity
0603 Case Size High Impedance Ferrite Chip Beads (Z-PWZ Series)							
Z0603C470BPWZT	0603	47 ±25%	100	0.02	3.5	0.8 ±0.1 (0.031 ±0.004)	4,000
Z0603C600BPWZT	0603	60 ±25%	100	0.025	3	0.8 ±0.1 (0.031 ±0.004)	4,000
Z0603C101BPWZT	0603	100 ±25%	100	0.035	2	0.8 ±0.1 (0.031 ±0.004)	4,000
Z0603C151BPWZT	0603	150 ±25%	100	0.05	2	0.8 ±0.1 (0.031 ±0.004)	4,000
Z0603C221BPWZT	0603	220 ±25%	100	0.07	1.5	0.8 ±0.1 (0.031 ±0.004)	4,000
Z0603C331BPWZT	0603	330 ±25%	100	0.13	0.9	0.8 ±0.1 (0.031 ±0.004)	4,000
Z0603C471BPWZT	0603	470 ±25%	100	0.15	0.7	0.8 ±0.1 (0.031 ±0.004)	4,000
Z0603C601BPWZT	0603	600 ±25%	100	0.17	0.7	0.8 ±0.1 (0.031 ±0.004)	4,000
Z0603C102BPWZT	0603	1000 ±25%	100	0.35	0.5	0.8 ±0.1 (0.031 ±0.004)	4,000
Z0603C300GPWZT	0603	30 ±25%	100	0.028	2.5	0.8 ±0.1 (0.031 ±0.004)	4,000
Z0603C600GPWZT	0603	60 ±25%	100	0.045	1.8	0.8 ±0.1 (0.031 ±0.004)	4,000
Z0603C121GPWZT	0603	120 ±25%	100	0.13	0.9	0.8 ±0.1 (0.031 ±0.004)	4,000
Z0603C221GPWZT	0603	220 ±25%	100	0.17	0.7	0.8 ±0.1 (0.031 ±0.004)	4,000
Z0603C331GPWZT	0603	330 ± 5%	100	0.21	0.6	0.8 ±0.1 (0.031 ±0.004)	4,000
Z0603C471GPWZT	0603	470 ±25%	100	0.35	0.5	0.8 ±0.1 (0.031 ±0.004)	4,000
Z0603C601GPWZT	0603	600 ±25%	100	0.45	0.4	0.8 ±0.1 (0.031 ±0.004)	4,000
0805 Case Size High Impedance Ferrite Chip Beads (Z-PWZ Series)							
Z0805C800BPWZT	0805	80 ±25%	100	0.025	2.7	0.85 ±0.2 (0.033 ±0.008)	4,000
Z0805C121BPWZT	0805	120 ±25%	100	0.032	2.5	0.85 ±0.2 (0.033 ±0.008)	4,000
0806 Case Size High Impedance Ferrite Chip Beads (Z-PWZ Series)							
Z0806C221BPWZT	0805	220 ±25%	100	0.06	2	0.85 ±0.2 (0.033 ±0.008)	4,000
Z0806C331BPWZT	0805	330 ±25%	100	0.08	1.8	0.85 ±0.2 (0.033 ±0.008)	4,000
Z0806C251BPWZT	0806	250 ±30%	100	0.05	2	1.6 ±0.2 (0.063 ±0.008)	2,000
1206 Case Size High Impedance Ferrite Chip Beads (Z-PWZ Series)							
Z1206C501BPWZT	1206	500 ±30%	100	0.07	2	1.6 ±0.2 (0.063 ±0.008)	2,000
1210 Case Size High Impedance Ferrite Chip Beads (Z-PWZ Series)							
Z1210C601BPWZT	1210	600 ±30%	100	0.042	3	2.5 ±0.3 (0.098 ±0.012)	1,000
Z1210C102BPWZT	1210	1000 ±30%	100	0.1	2	2.5 ±0.3 (0.098 ±0.012)	1,000
Z1210C202BPWZT	1210	2000 ±30%	100	0.13	1.2	2.5 ±0.3 (0.098 ±0.012)	1,000
1806 Case Size High Impedance Ferrite Chip Beads (Z-PWZ Series)							
Z1806C851BPWZT	1806	850 ±30%	100	0.1	1.5	1.6 ±0.2 (0.063 ±0.008)	1,000
1810 Case Size High Impedance Ferrite Chip Beads (Z-PWZ Series)							
Z1810C102BPWZT	1810	1000 ±30%	100	0.06	3	2.5 ±0.3 (0.098 ±0.012)	1,000
Z1810C162BPWZT	1810	1600 ±30%	100	0.13	2	2.5 ±0.3 (0.098 ±0.012)	1,000
1812 Case Size High Impedance Ferrite Chip Beads (Z-PWZ Series)							
Z1812C681BPWZT	1812	680 ±25%	100	0.028	4	3.2 ±0.3 (0.126 ±0.012)	2,000
Z1812C132BPWZT	1812	1300 ±25%	100	0.06	3	3.2 ±0.3 (0.126 ±0.012)	2,000
Z1812C202BPWZT	1812	2000 ±25%	100	0.13	1.3	3.2 ±0.3 (0.126 ±0.012)	2,000

Multilayer Ferrite Chip Beads - Z-SMS/Z-PMS Series

Z-SMS Features:

- Internal silver printed layer creates a closed circuit which acts as a magnetic shield to minimize heat generation and crosstalk
- No need for grounding provides greater circuit design flexibility
- Several material types and a broad range of impedance values provide noise countermeasures for various applications (10th digit in part number)
- "A" Suppresses the XL component. Helps stop the reduction of the wave-form integrity (digital wave-form overshoot, etc)
- "B" Increases the Z characteristics sharply above 20MHz and is applicable for radiated noise in the 100MHz-300MHz range. Especially effective on video signal lines.
- "C" Designed as a noise countermeasure for 200MHz-500MHz range where the rise of the Z component is in the high frequency area.
- "D" Intended for noise suppression around 200MHz. Effectively increase attenuation
- "E" The best material in the Z-SMS Series to suppress the XL component and stop the reduction of the wave-form integrity while maintaining attenuation in the high frequency area.
- "F" Reduced DC resistance version for noise countermeasures around LSI power supplies

Z-SMS Applications:

- High frequency noise countermeasure in personal computers, digital cameras and other information system products. For use on digital product clock lines and general signal lines.
- Radiated noise suppression in computer or printer interfaces harness connectors.
- Noise suppression in video and other AV products
- Prevents interference between circuits in cellular phones (PHS, PDC, etc)
- Due to the closed internal circuit which acts as a magnetic shield, the "F" material is extremely effective as a noise filter on LSI power supplies where downsizing of components is needed.

Z-PMS Applications:

- High frequency noise countermeasures on the DC power supply line in personal computers and other information system products
- Noise suppression in USB and IEEE1294 interface
- Prevents interference between circuits in mobile systems (PDC, PHS, PDA)

Operating Temperature:

- Z-SMS: -55°C to +125°C (includes self-generated heat)
- Z-PMS: -55°C to +85°C (includes self-generated heat)

Z-PMS Features:

- Low Rdc values reduce power dissipation and extend battery life
- No need for grounding provides greater circuit design flexibility

Part Numbering Table

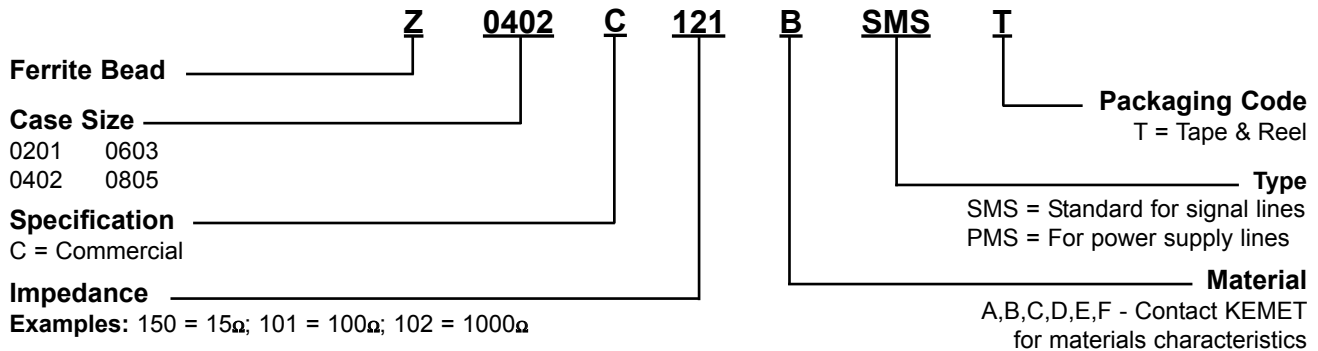

Dimension Table in millimeters (inches)

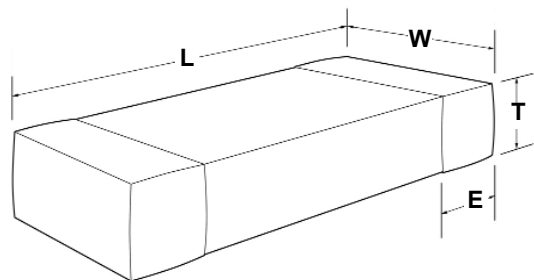

EIA Case Size	Metric Dim. Code	L Length (inches)	W Width (inches)	T Thickness Maximum (inches)	E (inches)
0201	0603	0.6 ±0.03 (0.2 ±0.001)	0.30 ±0.03 (0.012 ±0.001)	0.30 ±0.03 (0.012 ±0.001)	0.15 ±0.05 (0.006 ±0.002)
0402	1005	1.00 ±0.05 (0.039 ±0.002)	0.50 ±0.05 (0.020 ±0.002)	0.50 ±0.05 (0.020 ±0.002)	0.25 ±0.10 (0.010 ±0.004)
0603	1608	1.6 ±0.15 (0.063 ±0.006)	0.8 ±0.15 (0.031 ±0.006)	0.8 ±0.15 (0.031 ±0.006)	0.3 ±0.2 (0.012 ±0.008)
0805	2125	2.0 +0.3/-0.1 (0.079 +0.012/-0.004)	1.25 ±0.2 (0.049 ±0.008)	0.85 ±0.2 (0.033 ±0.008)	0.5 ±0.3 (0.020 ±0.012)

Multilayer Ferrite Chip Beads - Z-SMS, Z-PMS Series

0201 Multilayer Ferrite Chip Beads Standard Type (Z-SMS Series)

Ordering Code	Impedance (Ω) $\pm 25\%$	Measuring Frequency (MHz)	Maximum DC Resistance (Ω)	Maximum Rated Current (mA)	Thickness mm (inches)	Tape & Reel Packaging Quantity
Z0201C220ASMST	22	100	0.10	500	0.30 \pm 0.03 (0.012 \pm 0.001)	15,000
Z0201C330ASMST	33	100	0.20	350	0.30 \pm 0.03 (0.012 \pm 0.001)	15,000
Z0201C800ASMST	80	100	0.40	200	0.30 \pm 0.03 (0.012 \pm 0.001)	15,000
Z0201C121ASMST	120	100	0.50	200	0.30 \pm 0.03 (0.012 \pm 0.001)	15,000
Z0201C241ASMST	240	100	0.80	200	0.30 \pm 0.03 (0.012 \pm 0.001)	15,000
Z0201C600BSMST	60	100	0.40	200	0.30 \pm 0.03 (0.012 \pm 0.001)	15,000
Z0201C121BSMST	120	100	0.50	200	0.30 \pm 0.03 (0.012 \pm 0.001)	15,000
Z0201C241BSMST	240	100	0.80	200	0.30 \pm 0.03 (0.012 \pm 0.001)	15,000
Z0201C100CSMST	10	100	0.40	200	0.30 \pm 0.03 (0.012 \pm 0.001)	15,000
Z0201C220CSMST	22	100	0.50	200	0.30 \pm 0.03 (0.012 \pm 0.001)	15,000
Z0201C330CSMST	33	100	0.80	150	0.30 \pm 0.03 (0.012 \pm 0.001)	15,000
Z0201C470CSMST	47	100	1.00	150	0.30 \pm 0.03 (0.012 \pm 0.001)	15,000

0402 Multilayer Ferrite Chip Beads Standard Type (Z-SMS Series)

Ordering Code	Impedance (Ω) $\pm 25\%$	Measuring Frequency (MHz)	Maximum DC Resistance (Ω)	Maximum Rated Current (mA)	Thickness mm (inches)	Tape & Reel Packaging Quantity
Z0402C680ESMST	68	100	0.17	500	0.50 \pm 0.05 (0.020 \pm 0.002)	10,000
Z0402C121ESMST	120	100	0.24	450	0.50 \pm 0.05 (0.020 \pm 0.002)	10,000
Z0402C241ESMST	240	100	0.31	400	0.50 \pm 0.05 (0.020 \pm 0.002)	10,000
Z0402C431ESMST	430	100	0.50	350	0.50 \pm 0.05 (0.020 \pm 0.002)	10,000
Z0402C601ESMST	600	100	0.60	300	0.50 \pm 0.05 (0.020 \pm 0.002)	10,000
Z0402C100ASMST	10	100	0.05	1000	0.50 \pm 0.05 (0.020 \pm 0.002)	10,000
Z0402C330ASMST	33	100	0.10	700	0.50 \pm 0.05 (0.020 \pm 0.002)	10,000
Z0402C680ASMST	68	100	0.13	600	0.50 \pm 0.05 (0.020 \pm 0.002)	10,000
Z0402C121ASMST	120	100	0.23	500	0.50 \pm 0.05 (0.020 \pm 0.002)	10,000
Z0402C241ASMST	240	100	0.33	400	0.50 \pm 0.05 (0.020 \pm 0.002)	10,000
Z0402C601ASMST	600	100	0.58	300	0.50 \pm 0.05 (0.020 \pm 0.002)	10,000
Z0402C121BSMST	120	100	0.25	300	0.50 \pm 0.05 (0.020 \pm 0.002)	10,000
Z0402C241BSMST	240	100	0.36	300	0.50 \pm 0.05 (0.020 \pm 0.002)	10,000
Z0402C471BSMST	470	100	0.56	250	0.50 \pm 0.05 (0.020 \pm 0.002)	10,000
Z0402C601BSMST	600	100	0.59	250	0.50 \pm 0.05 (0.020 \pm 0.002)	10,000
Z0402C102BSMST	1000	100	0.80	150	0.50 \pm 0.05 (0.020 \pm 0.002)	10,000
Z0402C100CSMST	10	100	0.15	500	0.50 \pm 0.05 (0.020 \pm 0.002)	10,000
Z0402C220CSMST	22	100	0.20	400	0.50 \pm 0.05 (0.020 \pm 0.002)	10,000
Z0402C330CSMST	33	100	0.30	400	0.50 \pm 0.05 (0.020 \pm 0.002)	10,000
Z0402C470CSMST	47	100	0.35	350	0.50 \pm 0.05 (0.020 \pm 0.002)	10,000
Z0402C680CSMST	68	100	0.31	400	0.50 \pm 0.05 (0.020 \pm 0.002)	10,000
Z0402C121CSMST	120	100	0.45	350	0.50 \pm 0.05 (0.020 \pm 0.002)	10,000
Z0402C181CSMST	180	100	0.53	300	0.50 \pm 0.05 (0.020 \pm 0.002)	10,000
Z0402C241CSMST	240	100	0.70	250	0.50 \pm 0.05 (0.020 \pm 0.002)	10,000

0402 Multilayer Ferrite Chip Beads For Power Lines (Z-PMS Series)

Ordering Code	Impedance (Ω) $\pm 25\%$	Measuring Frequency (MHz)	Maximum DC Resistance (Ω)	Maximum Rated Current (mA)	Thickness mm (inches)	Tape & Reel Packaging Quantity
Z0402C121APMST	120	100	0.14	1000	0.50 \pm 0.05 (0.020 \pm 0.002)	10,000

0603 Multilayer Ferrite Chip Beads Standard Type (Z-SMS Series)

Ordering Code	Impedance (Ω) ±25%	Measuring Frequency (MHz)	Maximum DC Resistance (Ω)	Maximum Rated Current (mA)	Thickness mm (inches)	Tape & Reel Packaging Quantity
Z0603C121ESMST	120	100	0.15	600	0.80 ±0.15 (0.031 ±0.006)	4,000
Z0603C241ESMST	240	100	0.25	450	0.80 ±0.15 (0.031 ±0.006)	4,000
Z0603C431ESMST	430	100	0.30	400	0.80 ±0.15 (0.031 ±0.006)	4,000
Z0603C601ESMST	600	100	0.40	300	0.80 ±0.15 (0.031 ±0.006)	4,000
Z0603C220ASMST	22	100	0.05	1500	0.80 ±0.15 (0.031 ±0.006)	4,000
Z0603C330ASMST	33	100	0.08	1200	0.80 ±0.15 (0.031 ±0.006)	4,000
Z0603C470ASMST	47	100	0.10	900	0.80 ±0.15 (0.031 ±0.006)	4,000
Z0603C600ASMST	60	100	0.10	800	0.80 ±0.15 (0.031 ±0.006)	4,000
Z0603C800ASMST	80	100	0.10	600	0.80 ±0.15 (0.031 ±0.006)	4,000
Z0603C121ASMST	120	100	0.18	500	0.80 ±0.15 (0.031 ±0.006)	4,000
Z0603C241ASMST	240	100	0.25	400	0.80 ±0.15 (0.031 ±0.006)	4,000
Z0603C601ASMST	600	100	0.45	350	0.80 ±0.15 (0.031 ±0.006)	4,000
Z0603C102ASMST	1000	100	0.60	300	0.80 ±0.15 (0.031 ±0.006)	4,000
Z0603C121BSMST	120	100	0.20	350	0.80 ±0.15 (0.031 ±0.006)	4,000
Z0603C241BSMST	240	100	0.35	300	0.80 ±0.15 (0.031 ±0.006)	4,000
Z0603C471BSMST	470	100	0.45	250	0.80 ±0.15 (0.031 ±0.006)	4,000
Z0603C601BSMST	600	100	0.60	250	0.80 ±0.15 (0.031 ±0.006)	4,000
Z0603C102BSMST	1000	100	0.70	200	0.80 ±0.15 (0.031 ±0.006)	4,000
Z0603C300CSMST	30	100	0.20	500	0.80 ±0.15 (0.031 ±0.006)	4,000
Z0603C470CSMST	47	100	0.30	400	0.80 ±0.15 (0.031 ±0.006)	4,000
Z0603C560CSMST	56	100	0.30	400	0.80 ±0.15 (0.031 ±0.006)	4,000
Z0603C680CSMST	68	100	0.35	300	0.80 ±0.15 (0.031 ±0.006)	4,000
Z0603C121CSMST	120	100	0.50	300	0.80 ±0.15 (0.031 ±0.006)	4,000
Z0603C181CSMST	180	100	0.65	250	0.80 ±0.15 (0.031 ±0.006)	4,000
Z0603C241CSMST	240	100	0.80	250	0.80 ±0.15 (0.031 ±0.006)	4,000
Z0603C331CSMST	330	100	0.85	200	0.80 ±0.15 (0.031 ±0.006)	4,000
Z0603C431CSMST	430	100	0.85	200	0.80 ±0.15 (0.031 ±0.006)	4,000
Z0603C511CSMST	510	100	0.90	200	0.80 ±0.15 (0.031 ±0.006)	4,000
Z0603C681CSMST	680	100	1.00	150	0.80 ±0.15 (0.031 ±0.006)	4,000
Z0603C751DSMST	750	100	0.60	300	0.80 ±0.15 (0.031 ±0.006)	4,000
Z0603C152DSMST	1500	100	0.75	250	0.80 ±0.15 (0.031 ±0.006)	4,000
Z0603C182DSMST	1800	100	0.85	200	0.80 ±0.15 (0.031 ±0.006)	4,000
Z0603C252DSMST	2500	100	1.10	200	0.80 ±0.15 (0.031 ±0.006)	4,000
Z0603C431FSMST	430	100	0.25 ±30%	400	0.80 ±0.15 (0.031 ±0.006)	4,000
Z0603C601FSMST	600	100	0.27 ±30%	350	0.80 ±0.15 (0.031 ±0.006)	4,000
Z0603C102FSMST	1000	100	0.35 ±30%	300	0.80 ±0.15 (0.031 ±0.006)	4,000

0603 Multilayer Ferrite Chip Beads For Power Lines (Z-PMS Series)

Ordering Code	Impedance (Ω) ±25%	Measuring Frequency (MHz)	Maximum DC Resistance (Ω)	Maximum Rated Current (mA)	Thickness mm (inches)	Tape & Reel Packaging Quantity
Z0603C330APMST	33	100	0.025	3000	0.80 ±0.15 (0.031 ±0.006)	4,000
Z0603C600APMST	60	100	0.040	2500	0.80 ±0.15 (0.031 ±0.006)	4,000
Z0603C101APMST	100	100	0.050	1700	0.80 ±0.15 (0.031 ±0.006)	4,000
Z0603C121APMST	120	100	0.035	2700	0.80 ±0.15 (0.031 ±0.006)	4,000
Z0603C181APMST	180	100	0.075	1500	0.80 ±0.15 (0.031 ±0.006)	4,000
Z0603C271APMST	270	100	0.110	1200	0.80 ±0.15 (0.031 ±0.006)	4,000
Z0603C391APMST	390	100	0.140	1000	0.80 ±0.15 (0.031 ±0.006)	4,000

Multilayer Ferrite Chip Beads - Z-SMS, Z-PMS Series

0805 Multilayer Ferrite Chip Beads Standard Type (Z-SMS Series)

Ordering Code	Impedance (Ω) $\pm 25\%$	Measuring Frequency (MHz)	Maximum DC Resistance (Ω)	Maximum Rated Current (mA)	Thickness mm (inches)	Tape & Reel Packaging Quantity
Z0805C150ASMST	15	100	0.05	1200	0.85 \pm 0.2 (0.033 \pm 0.008)	4,000
Z0805C220ASMST	22	100	0.05	1200	0.85 \pm 0.2 (0.033 \pm 0.008)	4,000
Z0805C330ASMST	33	100	0.05	1200	0.85 \pm 0.2 (0.033 \pm 0.008)	4,000
Z0805C470ASMST	47	100	0.05	1000	0.85 \pm 0.2 (0.033 \pm 0.008)	4,000
Z0805C750ASMST	75	100	0.10	1000	0.85 \pm 0.2 (0.033 \pm 0.008)	4,000
Z0805C101ASMST	100	100	0.10	900	0.85 \pm 0.2 (0.033 \pm 0.008)	4,000
Z0805C121ASMST	120	100	0.15	800	0.85 \pm 0.2 (0.033 \pm 0.008)	4,000
Z0805C241ASMST	240	100	0.20	600	0.85 \pm 0.2 (0.033 \pm 0.008)	4,000
Z0805C431ASMST	430	100	0.25	500	0.85 \pm 0.2 (0.033 \pm 0.008)	4,000
Z0805C601ASMST	600	100	0.30	500	0.85 \pm 0.2 (0.033 \pm 0.008)	4,000
Z0805C102ASMST	1000	100	0.40	300	0.85 \pm 0.2 (0.033 \pm 0.008)	4,000
Z0805C121BSMST	120	100	0.15	800	0.85 \pm 0.2 (0.033 \pm 0.008)	4,000
Z0805C241BSMST	240	100	0.20	600	0.85 \pm 0.2 (0.033 \pm 0.008)	4,000
Z0805C471BSMST	470	100	0.25	500	0.85 \pm 0.2 (0.033 \pm 0.008)	4,000
Z0805C601BSMST	600	100	0.25	500	0.85 \pm 0.2 (0.033 \pm 0.008)	4,000
Z0805C102BSMST	1000	100	0.35	400	0.85 \pm 0.2 (0.033 \pm 0.008)	4,000
Z0805C560CSMST	56	100	0.20	600	0.85 \pm 0.2 (0.033 \pm 0.008)	4,000
Z0805C121CSMST	120	100	0.30	400	0.85 \pm 0.2 (0.033 \pm 0.008)	4,000
Z0805C241CSMST	240	100	0.35	300	0.85 \pm 0.2 (0.033 \pm 0.008)	4,000
Z0805C751DSMST	750	100	0.30	400	0.85 \pm 0.2 (0.033 \pm 0.008)	4,000
Z0805C152DSMST	1500	100	0.35	400	0.85 \pm 0.2 (0.033 \pm 0.008)	4,000
Z0805C182DSMST	1800	100	0.45	300	1.25 \pm 0.2 (0.049 \pm 0.008)	2,000
Z0805C252DSMST	2500	100	0.75	200	1.25 \pm 0.2 (0.049 \pm 0.008)	2,000

0805 Multilayer Ferrite Chip Beads For Power Lines (Z-PMS Series)

Ordering Code	Impedance (Ω) $\pm 25\%$	Measuring Frequency (MHz)	Maximum DC Resistance (Ω)	Maximum Rated Current (mA)	Thickness mm (inches)	Tape & Reel Packaging Quantity
Z0805C330APMST	33	100	0.020	4000	0.85 \pm 0.2 (0.033 \pm 0.008)	4,000
Z0805C600APMST	60	100	0.025	3000	0.85 \pm 0.2 (0.033 \pm 0.008)	4,000
Z0805C101APMST	100	100	0.040	2500	0.85 \pm 0.2 (0.033 \pm 0.008)	4,000
Z0805C221APMST	220	100	0.050	2000	0.85 \pm 0.2 (0.033 \pm 0.008)	4,000

DISCLAIMER

All electronic components or devices listed in this catalog are developed, designed and intended for use in general electronic equipment. Before incorporating these components into any equipment in the fields of aerospace, military or medical, where higher safety and reliability are required, please contact KEMET Corporation for more details.

World Sales Headquarters
KEMET Electronics Corporation
P.O. Box 5928
Greenville, SC 29606
Phone: 864-963-6300

Europe
KEMET Electronics S.A.
15bis chemin des Mines
1202 Geneva, Switzerland
Phone: 41-22-715-0100

Asia
KEMET Electronics Marketing PTE Ltd.
73 Bukit Timah Road
#05-01 Rex House
Singapore, 229832, Singapore
Phone: 65-6586-1900

KEMET Electronics Asia Ltd.
30 Canton Road, Room 1512
SilverCord Tower II
Tsimshatshui, Kowloon
Hong Kong
Phone: 852-2305-1168

Looking for pricing, stock, or lifecycle information?

Click below to explore more details on WIN SOURCE:

 [View Z1206C800APWST on WIN SOURCE](#)

 [Kemet Information](#)

Optimize Your Supply Chain with WIN SOURCE Solutions

-  Global Sourcing Solution
-  Obsolete Management
-  Cost Control Management
-  Shortage Management
-  Alternative Solution
-  Excess Inventory Management