



**THE DATASHEET OF
MLX90621ESF-BAB-000-TU**



MLX90621

16x4 IR array

Datasheet

Features and Benefits

- ❑ Small size, low cost 16x4 pixels IR array
- ❑ Easy to integrate
- ❑ Industry standard four lead TO39 package
- ❑ Factory calibrated infrared temperature measurement.
Calibration parameters stored in EEPROM.
- ❑ Noise Equivalent Temperature Difference (NETD)
0.20K RMS @4Hz refresh rate
- ❑ I²C compatible digital interface
- ❑ Programmable frame rate 0.5Hz...512Hz
- ❑ 2.6V supply voltage
- ❑ Current consumption less than 9mA
- ❑ Sleep mode consumption less than 7µA
- ❑ Measurement start trigger for synchronization with external control unit
- ❑ 3 FOV - 40°x10°, 60°x16° and 120°x25°
- ❑ Ta -40°C to 85°C
- ❑ To -20°C to 300°C
- ❑ Complies with RoHS regulations

Applications Examples

- ❑ High precision non-contact temperature measurements;
- ❑ Temperature sensing element for residential, commercial and industrial building air conditioning;
- ❑ Microwave ovens
- ❑ Home appliances with temperature control;
- ❑ Thermal Comfort sensor in automotive Air Conditioning control system;
- ❑ Passenger classification
- ❑ Automotive blind angle detection;
- ❑ Industrial temperature control of moving parts;
- ❑ Identifying thermal leaks in homes
- ❑ Thermal scanners
- ❑ Security / safety gates
- ❑ Intrusion / Movement detection;
- ❑ Presence detection / Person localization

Ordering Information

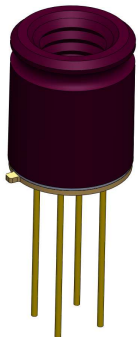

Part No.	Temperature Code	Package Code	Option Code	Standard part	Packing form
MLX90621	E (-40°C to 85°C)	SF (TO-39)	- X X X (1) (2) (3)	-000	-TU

(1) Supply Voltage
B = 2.6V

(2) Number of thermopiles:
A = 16X4

(3) Package options:
A = 120°x25° FOV
B = 60°x16° FOV
C = reserved
D = 40°x10° FOV

Example:
MLX90621ESF-BAB-000-TU

Functional diagram

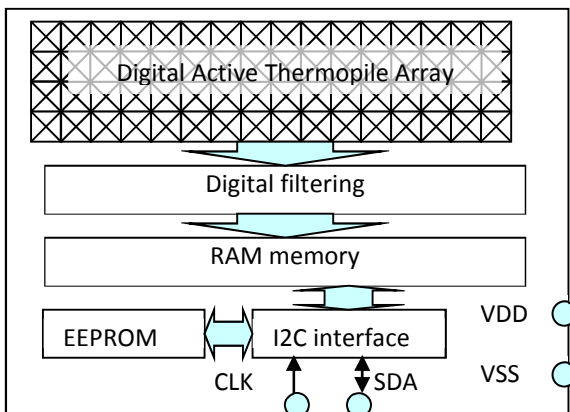

General Description

The MLX90621 is a fully calibrated 16x4 pixels IR array in an industry standard 4-lead TO-39 package. It contains 2 chips in one package: the MLX90670 (IR array with signal conditioning electronics) and the 24AA02 (256x8 EEPROM) chip.

The MLX90621 contains 64 IR pixels with dedicated low noise chopper stabilized amplifier and fast ADC integrated. A PTAT (Proportional To Absolute Temperature) sensor is integrated to measure the ambient temperature of the chip. The outputs of both IR and PTAT sensors are stored in internal RAM and are accessible through I²C.

General Description (continued)

The results of the infrared sensor measurements are stored in RAM:

- 15...18-bit result of IR measurement for each individual sensor (64 words)
- 15...18-bit result of PTAT sensor

Depending on the application, the external microcontroller can read the different RAM data and, based on the calibration data stored in the EEPROM memory, compensate for difference between sensors to build up a thermal image, or calculate the temperature at each spot of the imaged scene.

These constants are accessible by the user microcontroller through the I2C bus and have to be used for external post processing of the thermal data. This post processing includes:

- Ta calculation
- Pixel offset cancelling
- Pixel to pixel sensitivity difference compensation
- Object emissivity compensation
- Object temperature calculation

The result is an image with NETD better than 0.1K RMS at 1Hz refresh rate.

The refresh rate of the array is programmable by means of register settings or directly via I2C command. Changes of the refresh rate have a direct impact on the integration time and noise bandwidth (faster refresh rate means higher noise level). The frame rate is programmable in the range 0.5Hz...512Hz and can be changed to achieve the desired trade-off between speed and accuracy.

The MLX90621 requires a single 2.6V...3.2V although the device is calibrated and performs best at VDD=2.6V.

The MLX90621 is factory calibrated in following temperature ranges:

- -40°C...85°C for the ambient temperature sensor
- -50°C...300°C for the object temperature.

NOTE: The sensor can detect higher temperatures, but is not calibrated for temperatures above 300°C. See Table 21 for configuration specific properties.

Each pixel of the array measures the average temperature of all objects in its own Field Of View (called nFOV).

It is very important for the application designer to understand that the accuracy of the temperature measurement is very sensitive to the thermal equilibrium isothermal conditions (there are no temperature differences across the sensor package). The accuracy of the thermometer can be influenced by temperature differences in the package induced by causes like (among others): Hot electronics behind the sensor, heaters/coolers behind or beside the sensor or by a hot/cold object very close to the sensor that not only heats the sensing element in the thermometer but also the thermometer package.

1. Table of contents

1. Table of contents.....	3
2. Glossary of terms	5
3. Absolute Maximum ratings	5
4. Pin definition and description	6
5. Electrical characteristics	7
6. Block diagram	8
7. Principle of operation.....	9
7.1. Initialization.....	10
7.1.1. Reading configuration	11
7.2. Read measurement data (RAM data).....	12
7.2.1. PTAT data read	12
7.2.2. IR data read	12
7.3. Calculation	14
7.3.1. Calculation of absolute chip temperature Ta (sensor temperature)	14
7.3.2. Example for Ta calculations.....	15
7.3.3. Calculation of To.....	17
7.3.4. Example for To calculations.....	20
8. Detailed description, Block description.....	23
8.1. Pixel position	23
8.2. MLX90621 address map	24
8.2.1. RAM.....	24
8.2.2. Internal registers.....	25
8.2.2.1 Configuration register (0x92)	25
8.2.2.2 Trimming register (0x93).....	26
8.2.3. EEPROM.....	26
8.3. POR.....	28
8.4. ESD	28
9. Communication protocol	28
9.1. Communication pins	28
9.2. Low level communication protocol.....	29
9.2.1. Start / Stop condition	29
9.2.2. Device addressing.....	29
9.2.3. Acknowledge	29
9.2.4. Low level communication operation.....	29
9.3. Device modes	30
9.3.1. Normal mode	30
9.3.2. Step mode	30
9.3.3. Power saving mode	30
9.4. Communication to IR array	31
9.4.1. Start measurement command	31
9.4.2. Read command	31
9.4.3. Write configuration register command.....	32
9.4.4. Write trimming command.....	32
9.5. Communication to EEPROM.....	33
10. Performance Graphs	34
10.1. Temperature accuracy of the MLX90621	34
10.2. Noise performance and resolution	35
10.3. Field Of View (FOV)	36
11. Applications Information.....	37
11.1. Use of the MLX90621 thermometer in I ² C configuration	37

MLX90621

16x4 IR array

Datasheet



12. Application Comments	37
13. Standard information regarding manufacturability of Melexis products with different soldering processes.....	39
14. ESD Precautions	39
15. FAQ.....	40
16. Mechanical specification.....	42
16.1. Package outline	42
16.2. Part marking.....	43
17. References.....	44
18. Disclaimer	44

2. Glossary of terms

POR	Power On Reset
PTAT	Proportional To Absolute Temperature sensor (package temperature)
IR	Infra Red
IR_data	Infrared data (raw data from ADC proportional to IR energy received by the sensor)
ADC	Analog To Digital Converter
Ta	Ambient Temperature measured from the chip – (the package temperature)
To	Object Temperature, 'seen' from IR sensor
TGC	Temperature Gradient Coefficient
FOV	Field Of View
nFOV	Field Of View of N-th pixel
ESD	Electro-Static Discharge
EMC	Electro-Magnetic Compatibility
I ² C	Inter-Integrated Circuit communication protocol
SDA	Serial Data
SCL	Serial Clock
FpS	Frames per Second – data refresh rate
MD	Master Device
SD	Slave Device
TBD	To Be Defined
NA	Not Applicable

Table 1 Glossary of terms

3. Absolute Maximum ratings

Parameter	MLX90621
Supply Voltage, V _{DD} (over voltage)	5.5V
Supply Voltage, V _{DD} (operating max)	3.6V
Reverse Voltage (each pin)	-0.3 V
Operating Temperature Range, T _A	-40...+85°C
Storage Temperature Range, T _S	-40...+125°C
ESD Sensitivity (AEC Q100 002)	4kV
DC sink current, SDA	50 mA
DC source current, SDA	NA (open drain)
DC clamp current, SDA	25 mA
DC source current, SCL	NA (input only)
DC clamp current, SCL	25 mA

Table 2 Absolute maximum ratings for MLX90621

Exceeding the absolute maximum ratings may cause permanent damage. Exposure to absolute-maximum-rated conditions for extended periods may affect device reliability.

MLX90621

16x4 IR array

Datasheet

4. Pin definition and description

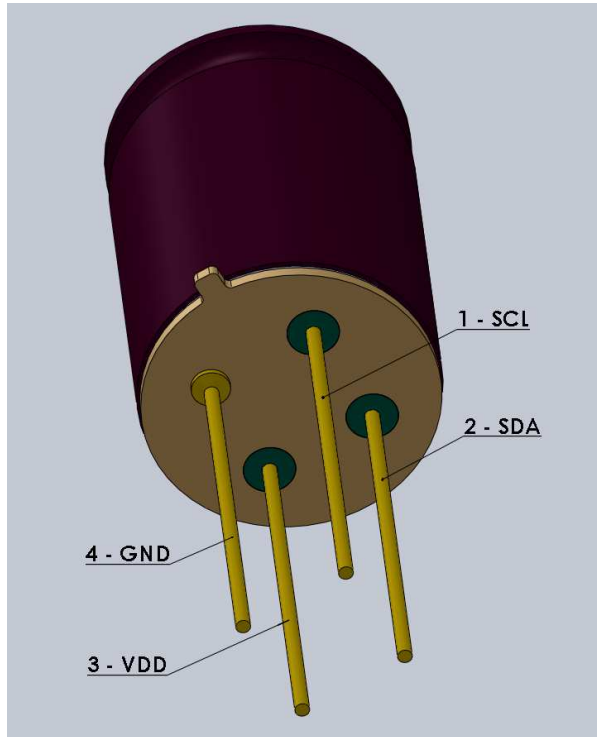

Figure 1 Pin description

Pin Name	Function
SCL	Serial clock input for 2 wire communications protocol
SDA	Digital input / output 2 wire communications protocol.
VDD	External supply voltage
VSS	Ground (case)

Table 3 Pin description for MLX90621

5. Electrical characteristics

All parameters are valid for $T_A = 25^\circ\text{C}$, $V_{DD} = 2.6\text{V}$ (unless otherwise specified)

Parameter	Symbol	Test Conditions	Min	Typ	Max	Units
Supplies						
External supply ¹	V_{DD}		2.5	2.6	3.3	V
Supply current	I_{DD}	No load		5	9	mA
Sleep current	I_{slp}	No load			7	μA
Power On Reset						
POR level	V_{POR_up}	Power-up (full temp range)	2	2.2	2.4	V
POR level	V_{POR_down}	Power-down (full temp range)	1.9	2.1	2.3	V
POR hysteresis	V_{POR_hys}	Full temp range		0.1		V
V_{DD} rise time (10% to 90% of specified supply voltage)	T_{POR}	Ensure POR signal	100			μs
I²C compatible 2-wire interface Sensor chip						
Slave address	SA	Factory default		60		hex
Input high voltage	$V_{IH}(T_a, V)$	Over temperature and supply	0.7VDD			V
Input low voltage	$V_{IL}(T_a, V)$	Over temperature and supply			0.3VDD	V
Output low voltage	V_{OL}	SDA over temperature and supply, $I_{sink} = 6\text{mA}$ (FM mode)			0.6	V
Output low voltage	V_{OL}	SDA over temperature and supply, $I_{sink} = 20\text{mA}$ (FM+ mode)			0.4	V
SCL leakage	I_{SCL_leak}	$V_{SCL}=4\text{V}$, $T_a=+85^\circ\text{C}$			2	μA
SDA leakage	I_{SDA_leak}	$V_{SDA}=4\text{V}$, $T_a=+85^\circ\text{C}$			2	μA
SCL capacitance	C_{SCL}	Two dies MLX90670 + EEPROM			20	pF
I ² C clock frequency	SCL_{IR}	MLX90621 (FM+ mode)			1	MHz
Acknowledge setup time	$T_{suac}(MD)$	8-th SCL falling edge, Master			0.45	μs
Acknowledge hold time	$T_{hdac}(MD)$	9-th SCL falling edge, Master			0.45	μs
Acknowledge setup time	$T_{suac}(SD)$	8-th SCL falling edge, Slave			0.45	μs
Acknowledge hold time	$T_{hdac}(SD)$	9-th SCL falling edge, Slave			0.45	μs
EEPROM						
Slave address	SA	Factory default		50		hex
I ² C clock frequency	SCL_{EEPROM}	EEPROM (FM mode)			400	kHz
Data retention		$T_a = +85^\circ\text{C}$	200			years
Erase/write cycles		$T_a = +25^\circ\text{C}$	1M			Times
Erase/write cycles		$T_a = +125^\circ\text{C}$	100K			Times
Erase cell time	T_{erase}				5	ms
Write cell time	T_{write}				5	ms

Table 4 Electrical specification parameters of MLX90621

1) The device can be supplied with $V_{DD} = 2.6...3.3\text{V}$ but the best performance is achieved at $V_{DD}=2.6\text{V}$. For supply voltages above 2.7V a compensation algorithm should be applied for compensating the temperature readings.

6. Block diagram

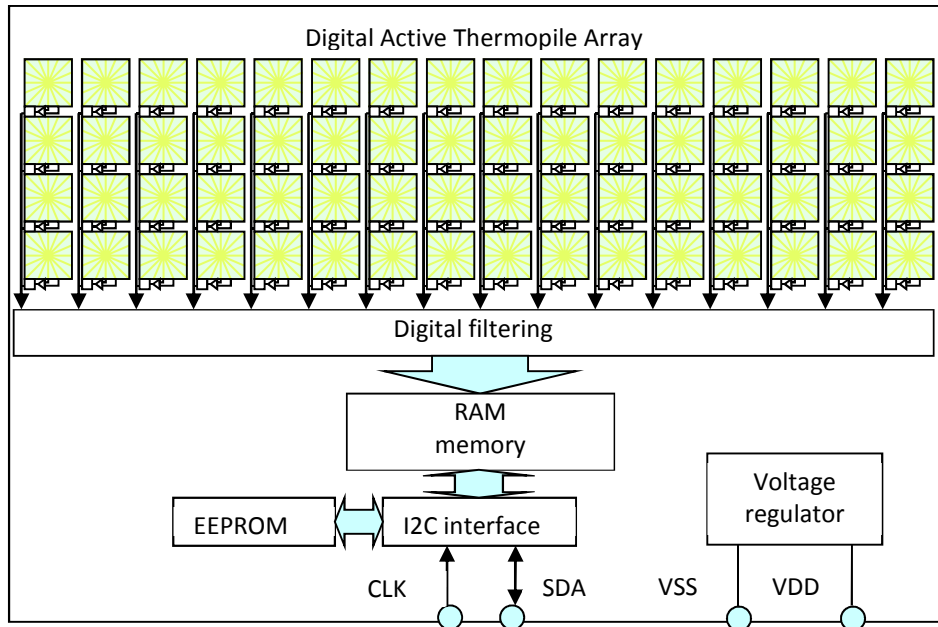

Figure 2 Block diagram

The device consists of 2 chips packed in single TO-39 package

- IR array and processing electronics
- EEPROM chip

7. Principle of operation

The output of all IR sensors and absolute temperature sensors is scanned according to the programmed refresh rate. Using their output data as well as calibration constants written in EEPROM the absolute chip temperature and object temperature, 'seen' by each pixel can be calculated. For this goal several sequential calculations must be done according to the Figure 3 Operation block diagram

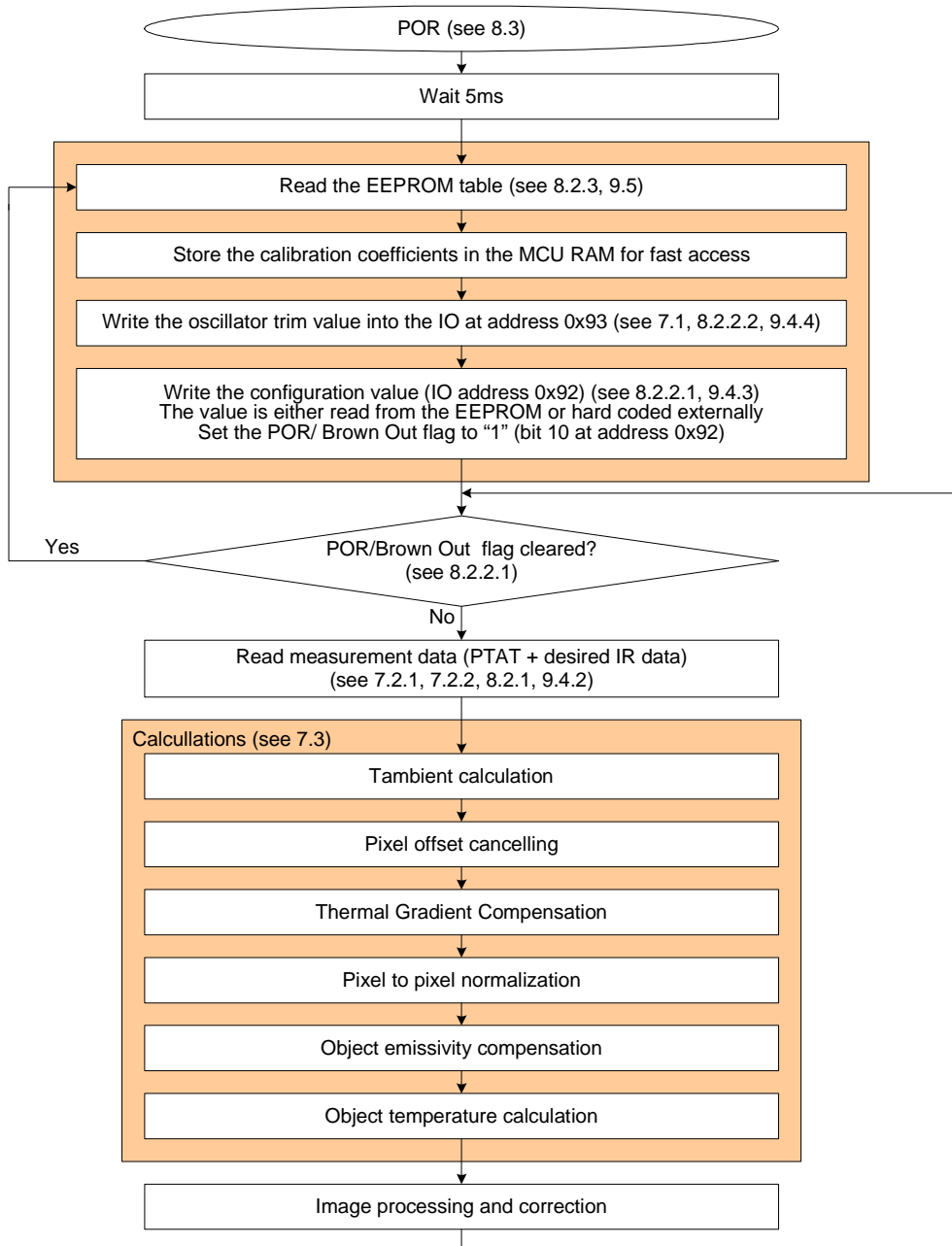

Figure 3 Operation block diagram

7.1. Initialization

After the POR is released the external MCU must execute an initialization procedure. This procedure must start at least 5ms after POR release.

- **Read the whole EEPROM** (see Figure 4). For maximum speed performance MELEXIS recommends that the whole calibration data is stored into the client MCU RAM. However it is possible to read the calibration data from the EEPROM only when needed during calculations. This will result in increased time for temperature calculation i.e. low refresh rate.

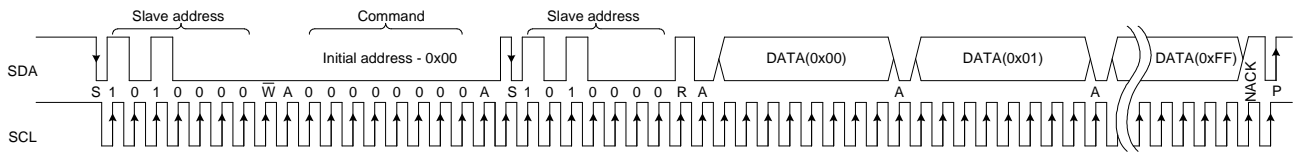

Figure 4 Whole EEPROM dump (SA = 0x50, command = 0x00)

- **Store the EEPROM content into customer MCU RAM** – This step could be omitted resulting in more data processing time because calibration data needs to be reread for each calculation
- **Write the oscillator trimming value** (extracted from EEPROM content at address 0xF7) into the corresponding register (0x93).

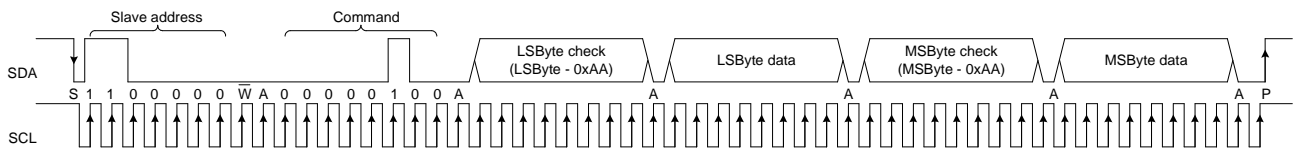

Figure 5 Write oscillator trimming (SA = 0x60, command = 0x04)

Example: If the value that has to be uploaded is 0x0052 the following sequence must be sent:

1. Start condition (Falling edge of SDA while SCL is high)
 2. Slave address (SA=0x60) plus write bit = 0xC0
 3. Command = 0x04
 4. LSByte check = LSByte – 0xAA = 0x52 – 0xAA = 0xA8
 5. LSByte = 0x52
 6. MSByte check = MSByte – 0xAA = 0x00 – 0xAA = 0x56
 7. MSbyte = 0x00
 8. Stop condition (Rising edge of SDA while SCL is high)
- **Write device configuration value.** In EEPROM addresses (0xF5 and 0xF6) MELEXIS provides a typical value of the configuration register (0x463E). So it is up to the user to copy that value or hardcode a new value to be loaded into the configuration register. If the EEPROM value is to be used the 16 bits are combined as follows:

For example: if EEPROM 0xF5 = 0x3E and 0xF6 = 0x46, the Configuration register value is:

$$\text{Configuration Register value} = \{0xF6: 0xF5\}$$

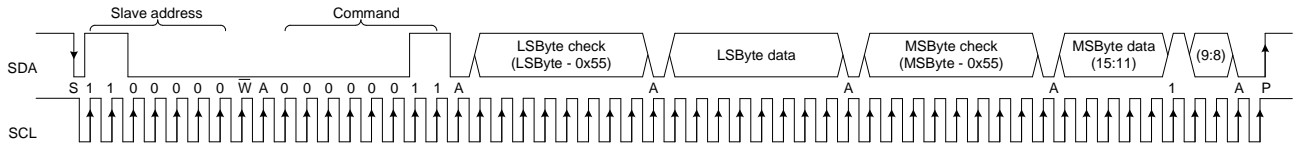

Figure 6 Write configuration register (SA = 0x60, command = 0x03)

NOTE: The user must ensure that the bit 10 (POR or Brown-out flag) in Configuration register is set to “1” by the MD. Furthermore, this bit must be checked regularly and if it is cleared it indicates that the device has been reset and the initialisation procedure must be redone.

Example: If the value that has to be uploaded is 0x463E the following sequence must be sent:

1. Start condition (Falling edge of SDA while SCL is high)
2. Slave address (SA=0x60) plus write bit = 0xC0
3. Command = 0x03
4. LSByte check = LSByte – 0x55 = 0x3E – 0x55 = 0xE9
5. LSbyte = 0x3E
6. MSByte check = MSByte – 0x55 = 0x46 – 0x55 = 0xF1
7. MSbyte = 0x46
8. Stop condition (Rising edge of SDA while SCL is high)

The default configuration is:

- IR and Ta refresh rate = 1Hz;
- Normal mode (no sleep);
- I²C FM+ mode enabled (maximum bit transfer up to 1000 Kbit/s);
- ADC low reference enabled;

7.1.1. Reading configuration

7.1.1.1 Reading configuration register (EEPROM data)

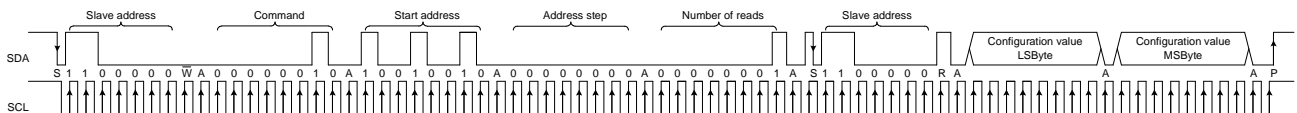

Figure 7 Reading configuration register (SA = 0x60, command = 0x02,
Start address = 0x92, Address step = 0x00, Number of reads = 0x01)

7.1.1.2 Reading oscillator trimming register (EEPROM data)

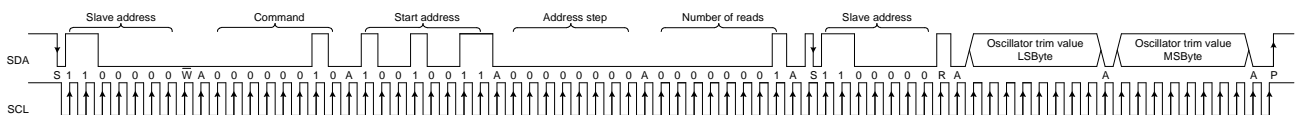

Figure 8 Reading configuration register (SA = 0x60, command = 0x02,
Start address = 0x93, Address step = 0x00, Number of reads = 0x01)

7.2. Read measurement data (RAM data)

7.2.1. PTAT data read

Absolute ambient temperature data of the device itself (package temperature) can be read by using following command:

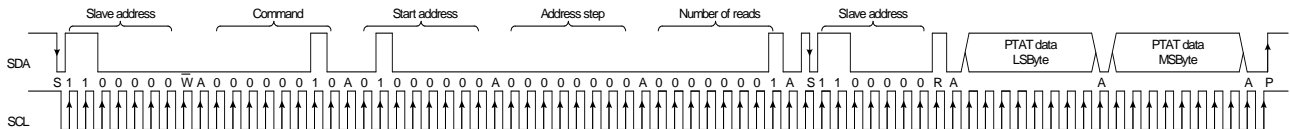

Figure 9 PTAT (SA = 0x60, command = 0x02, Start address = 0x40, Address step = 0x00, Number of reads = 0x01) measurement result read

$$PTATdata = \{PTATdata_{MSByte}:PTATdata_{LSByte}\}$$

7.2.2. IR data read

There are four options available for reading IR data: (See section 8.2.1 for an overview of the RAM addresses).

- **Whole frame read** (MELEXIS recommends the whole frame read for maximum refresh rate)

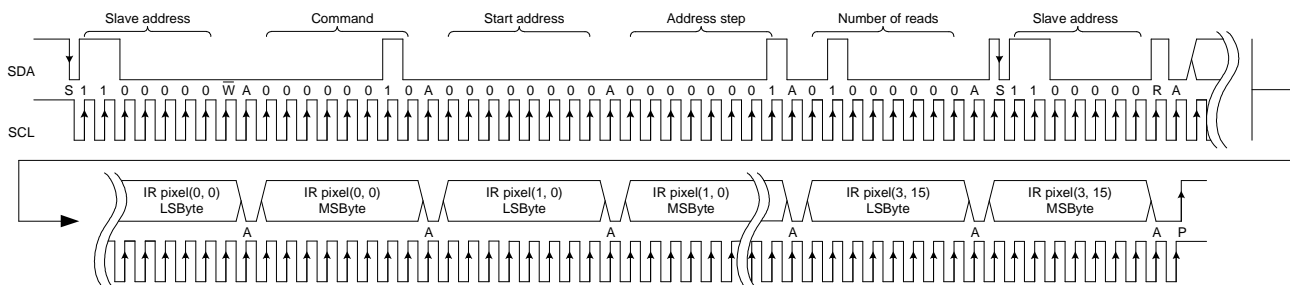

Figure 10 Whole frame (SA = 0x60, command = 0x02, Start address = 0x00, Address step = 0x01, Number of reads = 0x40) measurement result read

- **Single column read**

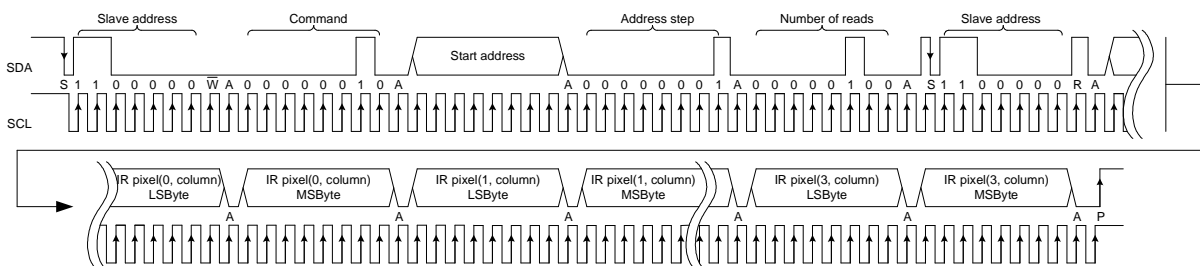

Figure 11 Single column (SA = 0x60, command = 0x02, Start address = 0x00...0x3C (step 0x04), Address step = 0x04, Number of reads = 0x04) measurement result read

– Single line read

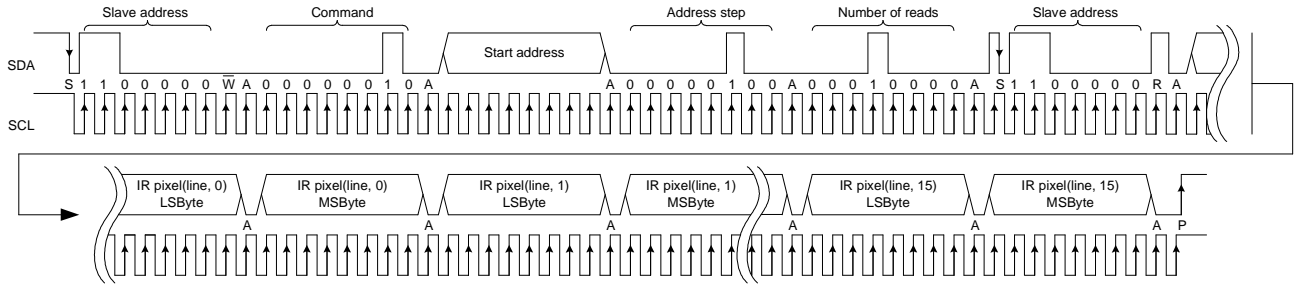

Figure 12 Single line (SA = 0x60, command = 0x02, Start address = 0x00...0x03 (step 0x01), Address step = 0x04, Number of reads = 0x10) measurement result read

– Single pixel read

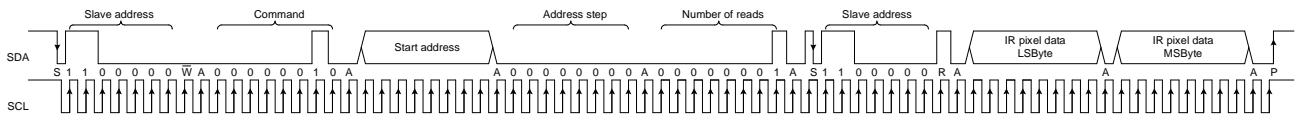

Figure 13 Single pixel (SA = 0x60, command = 0x02, Start address = 0x00...0x3F, Address step = 0x00, Number of reads = 0x01) measurement result read

– Compensation pixel read

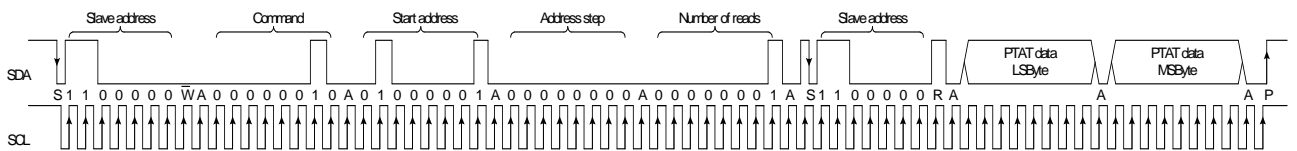

Figure 14 Compensation pixel (SA = 0x60, command = 0x02, Start address = 0x41, Address step = 0x00, Number of reads = 0x01) measurement result read

The 16bit data for each pixel is:

$$IRdata(i, j) = \{IRdata(i, j)_{MSByte} : IRdata(i, j)_{LSByte}\}$$

7.3. Calculation

7.3.1. Calculation of absolute chip temperature Ta (sensor temperature)

The output signal of the IR sensors is relative to the cold junction temperature. That is why we need to know the temperature of the die in order to be able to calculate the object temperature 'seen' by each pixel.

The Ta can be calculated using the formula:

$$T_a = \frac{-K_{T1} + \sqrt{K_{T1}^2 - 4K_{T2}[V_{TH}(25) - PTAT_data]}}{2K_{T2}} + 25, [^{\circ}\text{C}]$$

Constants $V_{TH}(25)$, K_{T1} and K_{T2} are stored in EEPROM at following addresses as two's complement values:

EEPROM address	Cell name	Stored as	Parameter
0xDA	V_{TH_L}	2's complement	V_{TH0} of absolute temperature sensor
0xDB	V_{TH_H}		
0xDC	K_{T1_L}	2's complement	K_{T1} of absolute temperature sensor
0xDD	K_{T1_H}		
0xDE	K_{T2_L}	2's complement	K_{T2} of absolute temperature sensor
0xDF	K_{T2_H}		
0xD2	K_{T_scale}	unsigned	[7:4] – K_{T1_scale} [3:0] – K_{T2_scale}

Table 5 EEPROM parameters for Ta calculations

$$V_{TH}(25) = 256 * V_{TH_H} + V_{TH_L}$$

$$\text{if } V_{TH}(25) > 32767 \rightarrow V_{TH}(25) = V_{TH}(25) - 65536$$

$$V_{TH}(25) = \frac{V_{TH}(25)}{2^{3-ConfigReg[5:4]}}$$

$$K_{T1} = 256 * K_{T1_H} + K_{T1_L}$$

$$\text{if } K_{T1} > 32767 \rightarrow K_{T1} = K_{T1} - 65536$$

$$K_{T1} = \frac{K_{T1}}{2^{EEPROM\ 0xD2[7:4]} * 2^{3-ConfigReg[5:4]}}$$

$$K_{T2} = 256 * K_{T2_H} + K_{T2_L}$$

$$\text{if } K_{T2} > 32767 \rightarrow K_{T2} = K_{T2} - 65536$$

$$K_{T2} = \frac{K_{T2}}{2^{EEPROM\ 0xD2[3:0]+10} * 2^{3-ConfigReg[5:4]}}$$

7.3.2. Example for Ta calculations

Let's assume that the values in EEPROM are as follows

(Derived using maximum resolution – ConfigRegister[5:4] = 11b):

EEPROM address	Cell name	Cell values (hex)
0xDA	V _{TH_L}	0x20
0xDB	V _{TH_H}	0x64
0xDC	K _{T1_L}	0x89
0xDD	K _{T1_H}	0x55
0xDE	K _{T2_L}	0x7E
0xDF	K _{T2_H}	0x5E
0xD2	K _{T_scale}	0x8B

Table 6 EXAMPLE for Ta calibration values

Let's assume that the maximum resolution is set in the configuration register:

ConfigRegister[5:4] = 11b

$$V_{TH}(25) = 256 * V_{TH_H} + V_{TH_L} = 256 * 100 + 32 = 25632$$

$$\text{Sign check: } 25632 < 32768 \rightarrow V_{TH}(25) = 25632$$

$$V_{TH}(25) = \frac{V_{TH}(25)}{2^{3-\text{ConfigReg}[5:4]}} = \frac{25632}{2^{3-3}} = 25632$$

$$K_{T1} = 256 * K_{T1_H} + K_{T1_L} = 256 * 85 + 137 = 21897$$

$$\text{Sign check: } 21897 < 32768 \rightarrow K_{T1} = 21897$$

$$K_{T1} = \frac{K_{T1}}{2^{\text{EEPROM } 0xD2[7:4]} * 2^{3-\text{ConfigReg}[5:4]}} = \frac{21897}{2^8 * 2^{3-3}} = 85.53515625$$

$$K_{T2} = 256 * K_{T2_H} + K_{T2_L} = 256 * 94 + 126 = 24190$$

$$\text{Sign check: } 24190 < 32768 \rightarrow K_{T2} = 24190$$

$$K_{T2} = \frac{K_{T2}}{2^{\text{EEPROM } 0xD2[3:0]+10} * 2^{3-\text{ConfigReg}[5:4]}} = \frac{24190}{2^{11+10} * 2^{3-3}} = 0.01153469085$$

MLX90621

16x4 IR array

Datasheet

Let's assume that the input data is:

$$PTAT_data = 0x67DE = 26590 \text{ dec}$$

Thus the ambient temperature is:

$$T_a = \frac{-K_{T1} + \sqrt{K_{T1}^2 - 4K_{T2}[V_{TH}(25) - PTAT_data]}}{2K_{T2}} + 25$$

$$T_a = \frac{-85.53515625 + \sqrt{7316.26295471 - 4 * 0.01153469085 * [25632 - 26590]}}{0.0230693817} + 25$$

$$T_a = \frac{-85.53515625 + \sqrt{7316.26295471 - 0.0461387634 * (-958)}}{0.0230693817} + 25$$

$$T_a = \frac{-85.53515625 + \sqrt{7360.46389005}}{0.0230693817} + 25 \approx \frac{-85.53515625 + 85.7931459386}{0.0230693817} + 25 \approx 11.1832077 + 25$$

$$T_a \approx 36.18 \text{ }^\circ\text{C}$$

The calculated values for the different resolution settings are given in the table below:

ConfigRegister[5:4] (bin)	PTAT data (hex)	VTH(25)	KT1	KT2	Ta, °C
00	0x0CFB	3323.750	10.69189453125	0.0014418363571167	36.18
01	0x19F7	6647.500	21.38378906250	0.0028836727142334	36.18
10	0x33EF	13295.000	42.76757812500	0.0057673454284668	36.18
11	0x67DE	26590.000	85.53515625000	0.0115346908569336	36.18

Table 7 Calculated values at different resolution settings

7.3.3. Calculation of To

Following formula is used to calculate the temperature seen by specific pixel in the matrix:

$$T_{O(i,j)} = \sqrt[4]{\frac{V_{IR(i,j)COMPENSATED}}{\alpha_{comp(i,j)} * (1 - K_{s4} * 273.15) + S_x(i,j)}} + T_{aK^4} - 273.15, [^\circ C]$$

Where:

$V_{IR(i,j)COMPENSATED}$ is the parasitic free IR compensated signal as calculated in 7.3.3.1

$\alpha_{comp(i,j)}$ is the compensated sensitivity coefficient for each pixel

K_{s4} is the compensation factor for the sensitivity – for BAB and BAD, $K_{s4} = 0$, resulting in a simplified formula

$T_{aK^4} = (T_a + 273.15)^4$ where T_a is the ambient temperature calculated in 7.3.2

$$S_x(i,j) = K_{s4} * \sqrt[4]{\alpha_{comp(i,j)}^3 * V_{IR(i,j)COMPENSATED} + \alpha_{comp(i,j)}^4 * T_{aK^4}}$$

7.3.3.1 Calculating $V_{IR(i,j)COMPENSATED}$

1. Offset compensation

$$V_{IR(i,j)OffsetCompensated} = V_{IR(i,j)} - (A_{i(i,j)} + B_{i(i,j)} * (T_a - T_{a0}))$$

Where:

$V_{IR(i,j)}$ is an individual pixel IR_data readout (RAM read)

$A_{i(i,j)}$ is an individual pixel offset restored from the EEPROM using the following formula:

$$A_{i(i,j)} = \frac{A_{common} + \Delta A_{i(i,j)} * 2^{\Delta A_{i_{scale}}}}{2^{3-ConfigReg[5:4]}}$$

A_{common} is the minimum offset value stored in the EEPROM at addresses 0xD0 and 0xD1 as 2's complement value

ΔA_i is the difference between the individual offset and the minimum value. It is stored in the EEPROM as unsigned values.

$\Delta A_{i_{scale}}$ is the scaling coefficient for the ΔA_i values and is stored in the EEPROM at address 0xD9[7:4] as an unsigned value

$B_{i(i,j)}$ is an individual pixel offset slope coefficient

$$B_{i(i,j)} = \frac{B_{i(i,j)EEPROM}}{2^{B_{i_{scale}} * 2^{3-ConfigReg[5:4]}}}$$

$B_{i(i,j)EEPROM}$ is the value stored in EEPROM as two's complements

$B_{i_{scale}}$ is a scaling coefficient for the slopes of IR pixels offset and is stored in the EEPROM at address 0xD9[3:0] as an unsigned value

T_a is the ambient temperature calculated in 7.3.2

$T_{a0} = 25^{\circ}\text{C}$ is a constant

NOTE: This applies to the compensation pixel as well (A_{CP} and B_{CP} while $B_{i_{scale}}$ is the same) with the only difference being that A_{CP} is stored in the EEPROM at addresses 0xD3 and 0xD4 as an unsigned value but not calculated

2. Thermal Gradient Compensation (TGC)

$$V_{IR(i,j)TGCCompensated} = V_{IR(i,j)OffsetCompensated} - TGC * V_{IRcpOffsetCompensated}$$

Where:

$V_{IRcpOffsetCompensated}$ is the offset compensated IR signal of the thermal gradient compensation pixel

$$TGC = \frac{TGC_{EEPROM}}{32}$$

TGC_{EEPROM} is a coefficient stored at EEPROM address 0xD8 as a two's complement value

3. Emissivity compensation

$$V_{IR(i,j)COMPENSATED} = \frac{V_{IR(i,j)TGCCompensated}}{\varepsilon}$$

Where:

ε is the emissivity coefficient. The scaled value is stored into EEPROM as unsigned value

$$\varepsilon = \frac{256 * \varepsilon_H + \varepsilon_L}{32768}$$

7.3.3.2 Calculating $\alpha_{comp(i,j)}$

$$\alpha_{comp(i,j)} = (1 + KsTa * (T_a - T_{a0})) * (\alpha_{(i,j)} - TGC * \alpha_{CP})$$

Where:

T_a is the ambient temperature calculated in 7.3.2

T_{a0} is a constant = 25°C

$KsTa$ is T_a dependence of $\alpha_{comp(i,j)}$ stored in EEPROM at addresses 0xE6 and 0xE7 as two's complement value and the scale coefficient is fixed to be 20.

$$KsTa = \frac{256 * KsTa_H + KsTa_L}{2^{20}}$$

$$\alpha_{(i,j)} = \frac{\frac{256 * \alpha_{0H} + \alpha_{0L}}{2^{\alpha_{scale}}} + \frac{\Delta \alpha_{(i,j)}}{2^{\Delta \alpha_{scale}}}}{2^{3 - ConfigReg[5:4]}}$$

$$\alpha_{CP} = \frac{256 * \alpha_{CPH} + \alpha_{CPL}}{2^{\alpha_{0scale} * 2^3 - ConfigReg[5:4]}}$$

α_{0H} , α_{0L} , α_{CPH} , α_{CPL} , $\Delta\alpha_{(i,j)}$, α_{0scale} and $\Delta\alpha_{scale}$ are stored in the EEPROM as unsigned values

7.3.3.1 Calculating K_{s4}

$$K_{s4} = \frac{K_{s4_EE}}{2^{(K_{s_scale}+8)}}, \text{ stored in EEPROM at addresses 0x9E as two's complement value}$$

All parameters necessary to calculate T_o are stored into EEPROM at following addresses:

EEPROM address	Cell name	Stored as	Parameter
0x00...0x3F	ΔA_i	unsigned	IR pixel individual offset delta coefficient
0x40...0x7F	$B_{i(i,j)}$	2's complement	Individual T_a dependence (slope) of IR pixels offset
0x80...0xBF	$\Delta\alpha_{(i,j)}$	unsigned	Individual sensitivity coefficient
0xC0	K_{s_scale}	unsigned	[7:4] – NA [3:0] – $K_{s_scale} - 8$
0xC4	K_{s4_EE}	2's complement	Sensitivity T_o dependence (slope)
0xD0	$A_{commonL}$	2's complement	IR pixel common offset coefficient
0xD1	$A_{commonH}$		
0xD3	A_{CPL}	2's complement	Compensation pixel individual offset coefficient
0xD4	A_{CPH}		
0xD5	B_{CP}	2's complement	Individual T_a dependence (slope) of the compensation pixel offset
0xD6	α_{CPL}	unsigned	Sensitivity coefficient of the compensation pixel
0xD7	α_{CPH}		
0xD8	TGC	2's complement	Thermal gradient coefficient
0xD9	$\Delta A_{iscale}, B_{iscale}$	unsigned	[7:4] – Scaling coeff for the IR pixels offset [3:0] – Scaling coeff of the IR pixels offset T_a dependence
0xE0	α_{0L}	unsigned	Common sensitivity coefficient of IR pixels
0xE1	α_{0H}		
0xE2	α_{0scale}	unsigned	Scaling coefficient for common sensitivity
0xE3	$\Delta\alpha_{scale}$	unsigned	Scaling coefficient for individual sensitivity
0xE4	ϵ_L	unsigned	Emissivity
0xE5	ϵ_H		
0xE6	$KsTa_L$	2's complement	$KsTa$ (fixed scale coefficient = 20)
0xE7	$KsTa_H$		

Table 8 EEPROM parameters for T_o calculations

7.3.4. Example for To calculations

Let's assume that we have following EEPROM data for pixel i=2, j=8:

EEPROM address	Cell name	Stored as	Cell values (hex)
0x22	ΔA_i	unsigned	0x21
0x62	$B_{i(i,j)}$	2's complement	0xBC
0xA2	$\Delta \alpha_{(i,j)}$	unsigned	0xCD
0xC0	K_{s_scale}	unsigned	0x99
0xC4	K_{s4}	2's complement	0x9E
0xD0	$A_{commonL}$	2's complement	0x8A
0xD1	$A_{commonH}$		0xFF
0xD3	A_{CPL}	2's complement	0x9D
0xD4	A_{CPH}		0xFF
0xD5	B_{CP}	2's complement	0xA2
0xD6	α_{CPL}	unsigned	0xA8
0xD7	α_{CPH}		0x0F
0xD8	TGC	2's complement	0x18
0xD9	$\Delta A_{i_scale}, B_{i_scale}$	unsigned	0x07
0xE0	α_{0L}	unsigned	0xAE
0xE1	α_{0H}		0x4E
0xE2	α_{0_scale}	unsigned	0x26
0xE3	$\Delta \alpha_{scale}$	unsigned	0x1F
0xE4	ϵ_L	unsigned	0x00
0xE5	ϵ_H		0x80
0xE6	$KsTa_L$	2's complement	0x0C
0xE7	$KsTa_H$		0x02

Table 9 EXAMPLE for To calibration values

Let's assume that we have the following input data:

$$V_{IR(2,8)} = 0x01B7 = 439, \text{ decimal value}$$

$$\text{Sign check } 439 < 32768 \rightarrow V_{IR(2,8)} = 439 \text{ LSB}$$

$$V_{CP} = 0xFFDC = 65500, \text{ decimal value (compensation pixel readings)}$$

$$\text{Sign check } 65500 > 32767 \rightarrow V_{CP} = 65500 - 65536 = -36 \text{ LSB}$$

$$T_a \approx 36.18 \text{ }^\circ\text{C (as calculated in 7.3.2)}$$

Reference routine for To computation:

$$T_{O(i,j)} = \sqrt[4]{\frac{V_{IR(i,j)COMPENSATED}}{\alpha_{comp(i,j)} * (1 - K_{s4} * 273.15) + S_x}} + T_{aK^4} - 273.15, [^{\circ}C]$$

$$V_{IR(2,8)OffsetCompensated} = V_{IR(2,8)} - (A_{i(2,8)} + B_{i(2,8)} * (T_a - T_{a0}))$$

$$A_{i(2,8)} = \frac{A_{common} + \Delta A_{i(2,8)} * 2^{\Delta A_{i_scale}}}{2^{(3-ConfigReg[5:4])}}$$

$$A_{common} = 256 * A_{common_H} + A_{common_L} = 256 * 255 + 138 = 65418 \text{ LSB decimal value}$$

$$\text{Sign check } 65418 > 32767 \rightarrow A_{common} = 65418 - 65536 = -118 \text{ LSB}$$

$$\Delta A_i = 33 \text{ LSB}$$

$$A_{i(2,8)} = \frac{A_{common} + \Delta A_{i(2,8)} * 2^{\Delta A_{i_scale}}}{2^{(3-ConfigReg[5:4])}} = \frac{-118 + 33 * 2^0}{2^{(3-3)}} = -85 \text{ LSB}$$

$$B_{i(2,8)} = \frac{B_{i(2,8)}}{2^{B_{i_scale} * 2^{(3-ConfigReg[5:4])}}}$$

$$B_{i(2,8)_{EE}} = 188$$

$$\text{Sign check } 188 > 127 \rightarrow B_{i(2,8)} = 188 - 256 = -68$$

$$B_{i(2,8)} = \frac{B_{i(2,8)}}{2^{B_{i_scale} * 2^{(3-ConfigReg[5:4])}}} = \frac{-68}{2^7 * 2^{(3-3)}} = -0.53125$$

$$V_{IR(2,8)OffsetCompensated} = 439 - (-85 - 0.53125 * (36.18 - 25)) \approx 529.939375 \text{ LSB}$$

$$A_{CP} = 256 * A_{CP_H} + A_{CP_L} = 65437, \text{ decimal value}$$

$$\text{Sign check } 65437 > 32768 \rightarrow A_{CP} = 65437 - 65536 = -99 \text{ LSB}$$

$$A_{CP} = \frac{A_{CP}}{2^{(3-ConfigReg[5:4])}} = \frac{-99}{2^{(3-3)}} = -99$$

$$B_{CP_{EE}} = 162$$

$$\text{Sign check } 162 > 127 \rightarrow B_{CP} = 162 - 256 = -94$$

$$B_{CP} = \frac{B_{CP}}{2^{B_{i_scale} * 2^{(3-ConfigReg[5:4])}}} = \frac{-94}{2^7 * 2^{(3-3)}} = -0.734375$$

$$V_{IRCPOffsetCompensated} = V_{CP} - (A_{CP} + B_{CP} * (T_a - T_{a0})) = -36 - (-99 - 0.734375 * (36.18 - 25))$$

$$V_{IRCPOffsetCompensated} \approx 71.2103125 \text{ LSB}$$

$$TGC_{EEPROM} = 0x18 = 24, \text{ decimal value}$$

$$\text{Sign check } 24 < 128 \rightarrow TGC_{EEPROM} = 24$$

$$TGC = \frac{TGC_{EEPROM}}{32} = \frac{24}{32} = 0.75$$

$$V_{IR(2,8)TGCCompensated} = V_{IR(2,8)OffsetCompensated} - TGC * V_{IRCPOffsetCompensated}$$

$$V_{IR(2,8)TGCCompensated} = 529.939375 - 0.75 * 71.2103125 \approx 475.531640625 \text{ LSB}$$

$$\varepsilon = \frac{256 * \varepsilon_H + \varepsilon_L}{32768} = \frac{256 * 128 + 0}{32768} = \frac{32768}{32768} = 1$$

$$V_{IR(2,8)COMPENSATED} = \frac{V_{IR(2,8)TGCCompensated}}{\varepsilon} = 475.531640625 \text{ LSB}$$

$$\alpha_{comp(2,8)} = (1 + KsTa * (T_a - T_{a0})) * (\alpha_{(2,8)} - TGC * \alpha_{CP})$$

$$KsTa = 256 * KsTa_H + KsTa_L = 256 * 2 + 12 = 524, \text{ decimal value}$$

$$\text{Sign check } 524 > 32768 \rightarrow A_{CP} = 524 \text{ LSB}$$

$$KsTa = \frac{524}{2^{20}} = 4.9972534 \cdot 10^{-4} \text{ decimal value}$$

$$\alpha_{(2,8)} = \frac{\frac{256 * \alpha_{0H} + \alpha_{0L}}{2^{\alpha_{0scale}}} + \frac{\Delta \alpha_{(2,8)}}{2^{\Delta \alpha_{scale}}}}{2^{(3-ConfigReg[5:4])}} = \frac{\frac{256 * 78 + 174}{2^{38}} + \frac{205}{2^{31}}}{2^{(3-3)}} = \frac{\frac{20142}{2^{38}} + \frac{205}{2^{31}}}{2^{(3-3)}} \approx 1.68736733031 \cdot 10^{-7}$$

$$\alpha_{CP} = \frac{256 * \alpha_{CPH} + \alpha_{CPL}}{2^{\alpha_{0scale} * 2^{3-ConfigReg[5:4]}}} = \frac{256 * 15 + 168}{2^{38 * 2^{(3-3)}}} = \frac{4008}{2^{38}} \approx 1.45810190588 \cdot 10^{-8}$$

$$\alpha_{comp(2,8)} = (1 + 4.9972534 \cdot 10^{-4} * (36.18 - 25)) * (1.68736733031 \cdot 10^{-7} - 0.75 * 1.45810190588 \cdot 10^{-8})$$

$$\alpha_{comp(2,8)} = 1.58682591595 \cdot 10^{-7}$$

$$K_{S4} = 158 \text{ decimal value}$$

$$\text{Sign check } 158 > 127 \rightarrow K_{S4} = 158 - 256 = -98$$

$$K_{S4} = \frac{K_{S4}}{2^{(K_{S4}scale+8)}} = \frac{-98}{2^{(9+8)}} = -7.476806640625 \cdot 10^{-4}$$

$$T_{aK^4} = (T_a + 273.15)^4 = (36.18 + 273.15)^4 = 9155628583$$

$$S_x = K_{S4} * \sqrt[4]{\alpha_{comp(2,8)}^3 * V_{IR(2,8)COMPENSATED} + \alpha_{comp(2,8)}^4 * T_{aK^4}}$$

$$S_x = -7.476806640625 \cdot 10^{-4} * \sqrt[4]{(1.58682591595 \cdot 10^{-7})^3 * 475.531640625 + (1.58682591595 \cdot 10^{-7})^4 * 9155628583}$$

$$S_x = -3.93973510355 \cdot 10^{-8}$$

$$T_{O(2,8)} = \sqrt[4]{\frac{V_{IR(2,8)COMPENSATED}}{\alpha_{comp(2,8)} * (1 - K_{S4} * 273.15) + S_x}} + T_{aK^4} - 273.15 \text{ } ^\circ\text{C}$$

$$T_{O(2,8)} = \sqrt[4]{\frac{475.531640625}{1.58682591595 \cdot 10^{-7} * (1 - (-7.476806640625 \cdot 10^{-4}) * 273.15) + (-3.93973510355 \cdot 10^{-8})}} + 9155628583 - 273.15 \text{ } ^\circ\text{C}$$

$$T_{O(2,8)} = 59.8546263694257 \approx 59.85 \text{ } ^\circ\text{C}$$

The calculated values for the different resolution settings are given in the table below:

ConfigRegister[5:4] (bin)	$V_{IR(2,8)}$	V_{CP}	$V_{IR(2,8)COMPENSATED}$	$\alpha_{comp(2,8)}$	S_x	$T_o, ^\circ C$
00	0x0036	0xFFFFB	59.066455078125	1.98353239494464E-08	-4.9221144181793E-09	59.67
01	0x006D	0xFFFF7	118.38291015625	3.96706478988929E-08	-9.8455068127298E-09	59.72
10	0x00DB	0xFFEE	237.7658203125	7.93412957977857E-08	-1.9696122547076E-08	59.81
11	0x01B7	0xFFDC	476.531640625	1.58682591595571E-07	-3.9397351035512E-08	59.85

Table 10 Calculated values at different resolution settings

8. Detailed description, Block description

8.1. Pixel position

The array consists of 64 IR sensors (also called pixels). Each pixel is identified with its row and column position as $Pix(i,j)$ where i is its row number (from 0 to 3) and j is its column number (from 0 to 15)

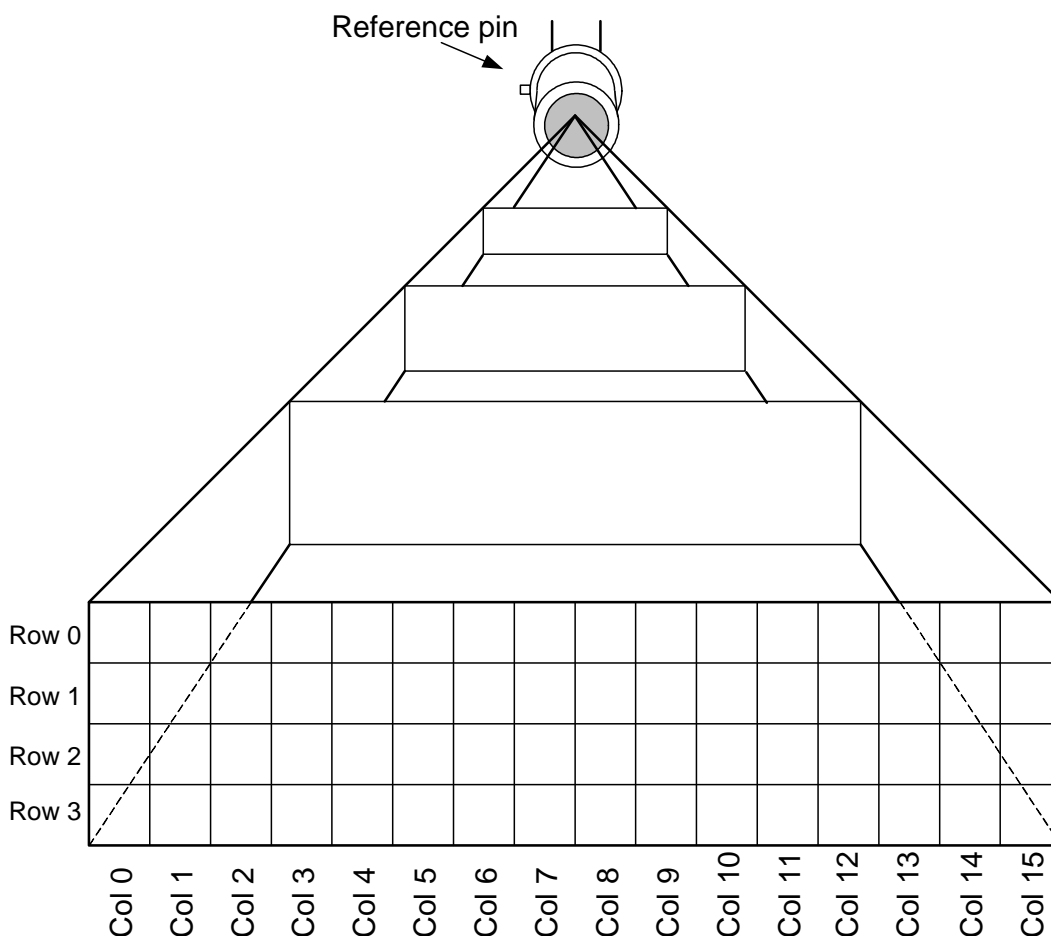

Figure 15 Pixel position in the whole FOV

8.2. MLX90621 address map

The MLX90621 address map is shown below:

0x00	RAM
0x41	
0x42	Not used
0x91	
0x92	Configuration registers
0x93	
0x93	Not used
0xFF	

Figure 16 Address map

8.2.1. RAM

The on chip 146x16 RAM is accessible for reading via I²C. The RAM is used for storing the results of measurements of pixels and Ta sensor and is distributed as follows:

- 64 words for IR sensors. The data is in 2's complement format (see 7.2.2)
- 1 word for measurement result of PTAT sensor. The data is 16 bit without sign. (see 7.2.1)

The memory map of the RAM is shown below:

RAM Address	RAM variable description
0x00	IR sensor (0,0) result
0x01	IR sensor (1,0) result
0x02	IR sensor (2,0) result
0x03	IR sensor (3,0) result
0x04	IR sensor (0,1) result
0x05	IR sensor (1,1) result
...	...
0x3B	IR sensor (3,14) result
0x3C	IR sensor (0,15) result
0x3D	IR sensor (1,15) result
0x3E	IR sensor (2,15) result
0x3F	IR sensor (3,15) result
0x40	PTAT sensor result
0x41	Compensation pixel result

Table 11: Result address map

For IR sensors results, the addressing can be summarized:

IR(x,y) is on address:

$$IR(x, y)address = x + 4.y$$

8.2.2. Internal registers

8.2.2.1 Configuration register (0x92)

The configuration register defines the chip operating modes. It can be read and written by the I²C MD.

15	14	13	12	11	10	9	8	7	6	5	4	3	2	1	0	Configuration register bit meaning (0x92)
												0	0	0	0	- IR Refresh rate = 512Hz
												0	0	0	1	- IR Refresh rate = 512Hz
												0	0	1	0	- IR Refresh rate = 512Hz
												0	0	1	1	- IR Refresh rate = 512Hz
												0	1	0	0	- IR Refresh rate = 512Hz
												0	1	0	1	- IR Refresh rate = 512Hz
												0	1	1	0	- IR Refresh rate = 256Hz
												0	1	1	1	- IR Refresh rate = 128Hz
												1	0	0	0	- IR Refresh rate = 64Hz
												1	0	0	1	- IR Refresh rate = 32Hz
												1	0	1	0	- IR Refresh rate = 16Hz
												1	0	1	1	- IR Refresh rate = 8Hz
												1	1	0	0	- IR Refresh rate = 4Hz
												1	1	0	1	- IR Refresh rate = 2Hz
												1	1	1	0	- IR Refresh rate = 1Hz (default)
												1	1	1	1	- IR Refresh rate = 0.5Hz
												0	0			ADC set to 15 bit resolution ^{*1}
												0	1			ADC set to 16 bit resolution ^{*1}
												1	0			ADC set to 17 bit resolution ^{*1}
												1	1			ADC set to 18 bit resolution ^{*1}
												0				- Continuous measurement mode (default)
												1				- Step mode
												0				- Normal operation mode (default)
												1				- Sleep mode
												x				- NA
												0				- No IR measurement running (flag only cannot be written)
												1				- IR measurement running (flag only cannot be written)
												0				- POR or Brown-out occurred - Need to reload Configuration register
												1				- MD must write "1" during uploading Configuration register (default)
												0				- I ² C FM+ mode enabled (max bit transfer rates up to 1000 kbit/s) (default)
												1				- I ² C FM+ mode disabled (max bit transfer rates up to 400 kbit/s)
												0				- EEPROM enabled
												1				- EEPROM disabled
												0				- Melexis reserved
												0				- ADC high reference enabled ^{*2}
												1				- ADC low reference enabled (default)
												0				- Melexis reserved

Table 12: Configuration register bit meaning

*1 – does not impacting the calibration of the device (may be changed and the calibration remain valid)

*2 – does impact the calibration of the device (if changed the calibration is no longer valid)

8.2.2.2 Trimming register (0x93)

It can be read and written by the I²C MD.

15	14	13	12	11	10	9	8	7	6	5	4	3	2	1	0	Trimming register bit meaning (0x93)
										7 bit value			- Oscillator trim value			
x	x	x	x	x	x	x	x	x	NA							

Table 13 Oscillator trim bit meaning

8.2.3. EEPROM

A 2kbit, organized as 256x8 EEPROM is built in the MLX90621. The EEPROM has a separate I²C address SA=0x50 and is used to store the calibration constants and the configuration of the device.

Address	0	1	2	3	4	5	6	7
00	$\Delta A_i(0,0)$	$\Delta A_i(1,0)$	$\Delta A_i(2,0)$	$\Delta A_i(3,0)$	$\Delta A_i(0,1)$	$\Delta A_i(1,1)$	$\Delta A_i(2,1)$	$\Delta A_i(3,1)$
08	...							
10	...							
18	ΔA_i - IR pixels individual offset coefficients							
20	...							
28	...							
30	...							
38	$\Delta A_i(0,14)$	$\Delta A_i(1,14)$	$\Delta A_i(2,14)$	$\Delta A_i(3,14)$	$\Delta A_i(0,15)$	$\Delta A_i(1,15)$	$\Delta A_i(2,15)$	$\Delta A_i(3,15)$
40	$B_i(0,0)$	$B_i(1,0)$	$B_i(2,0)$	$B_i(3,0)$	$B_i(0,1)$	$B_i(1,1)$	$B_i(2,1)$	$B_i(3,1)$
48	...							
50	...							
58	B_i - Individual Ta dependence (slope) of IR pixels offset							
60	...							
68	...							
70	...							
78	$B_i(0,14)$	$B_i(1,14)$	$B_i(2,14)$	$B_i(3,14)$	$B_i(0,15)$	$B_i(1,15)$	$B_i(2,15)$	$B_i(3,15)$
80	$\Delta \alpha(0,0)$	$\Delta \alpha(1,0)$	$\Delta \alpha(2,0)$	$\Delta \alpha(3,0)$	$\Delta \alpha(0,1)$	$\Delta \alpha(1,1)$	$\Delta \alpha(2,1)$	$\Delta \alpha(3,1)$
88	...							
90	...							
98	Individual sensitivity coefficients							
A0	...							
A8	...							
B0	...							
B8	$\Delta \alpha(0,14)$	$\Delta \alpha(1,14)$	$\Delta \alpha(2,14)$	$\Delta \alpha(3,14)$	$\Delta \alpha(0,15)$	$\Delta \alpha(1,15)$	$\Delta \alpha(2,15)$	$\Delta \alpha(3,15)$
C0	K_{s_scales}	reserved	reserved	reserved	K_{s4}	reserved	reserved	reserved
C8	reserved	reserved	reserved	reserved	reserved	reserved	reserved	
D0	A common		KT scale	Compensation pixel coefficients				
D8	TGC	Scale offset	PTAT					
E0	Common sensitivity coefficients				Emissivity		$KsTa_L$	$KsTa_H$
E8	MELEXIS reserved							
F0	MELEXIS reserved					Configuration register		OSC trim
F8	Chip ID							

Table 14: EEPROM map

Detailed descriptions of some of the EEPROM addresses are described here after:

C7	C6	C5	C4	C3	C2	C1	C0	EEPROM cell meaning
							Ks_scale	[7:4] - reserved [3:0] - Ks_scale - 8
								- MLX reserved

Table 15: C0...C7 EEPROM cell meaning

D7	D6	D5	D4	D3	D2	D1	D0	EEPROM cell meaning
						AcommonH	AcommonL	- common offset
					KT scale	[7:4] - KT1 scale [3:0] - KT2 scale -10		
			A _{CPH}	A _{CPL}				- Compensation pixel individual offset
		B _{CP}						- Individual Ta dependence (slope) of the compensation pixel offset
Δα _{CP_H}	Δα _{CP_L}							- Sensitivity coefficient of the compensation pixel

Table 16: D0...D7 EEPROM cell meaning

DF	DE	DD	DC	DB	DA	D9	D8	EEPROM cell meaning
							TGC	- Thermal Gradient Coefficient
						Offset scale	[7:4] - Aiscale [3:0] - Bscale	
				V _{th_H}	V _{th_L}			- Vth0 of absolute temperature sensor
		K _{T1_H}	K _{T1_L}					- K _{T1} of absolute temperature sensor
K _{T2_H}	K _{T2_L}							- K _{T2} of absolute temperature sensor

Table 17: DF...D8 EEPROM cell meaning

E7	E6	E5	E4	E3	E2	E1	E0	EEPROM cell meaning
						α _{0_H}	α _{0_L}	- Common sensitivity coefficient
					α _{0_scale}			- Common sensitivity scaling coefficient
				Δα _{scale}				- Individual sensitivity scaling coefficient
		ε _H	ε _L					- Emissivity coefficient
MELEXIS reserved								- MELEXIS reserved

Table 18: E7...E0 EEPROM cell meaning

F7	F6	F5	F4	F3	F2	F1	F0	EEPROM cell meaning
								MELEXIS reserved
								- MELEXIS reserved
	CFG_H	CFG_L						- Config register value
OSC_trim								- Oscillator trimming value

Table 19: F7...F0 EEPROM cell meaning

8.3. POR

The Power On Reset (POR) is connected to the Vdd supply. The on-chip POR circuit provides an active level of the POR signal when the Vdd voltage rises above approximately 0.5V and holds the entire MLx90621 in reset until the Vdd is higher than 2.4V. The device will start approximately 5ms after the POR release.

8.4. ESD

ESD, 4KV Human Body Model (please check with electrical specification)

9. Communication protocol

The device supports Fast Mode Plus I²C FM+ (IR array only up to 1MHz while the EEPROM can handle only up to 400 kHz) and will work in slave mode only.

The master device must provide the clock signal (SCL) for the communication. The data line SDA is bidirectional and is driven by the master or the slave depending on the command. The selection of the SDA occupant is done according to the I²C specification. As the SDA is an open-drain IO, '0' is transmitted by forcing the line 'LOW' and a '1' just by releasing it. During data transfer, the data line could be changed only while SCL is low. Otherwise, it would be interpreted as a start/stop condition

9.1. Communication pins

There are two communication pins SCL and SDA. SCL is an input only for the MLX90621 while the SDA pin is a bidirectional one. The SDA line should be wired in an open-drain configuration.

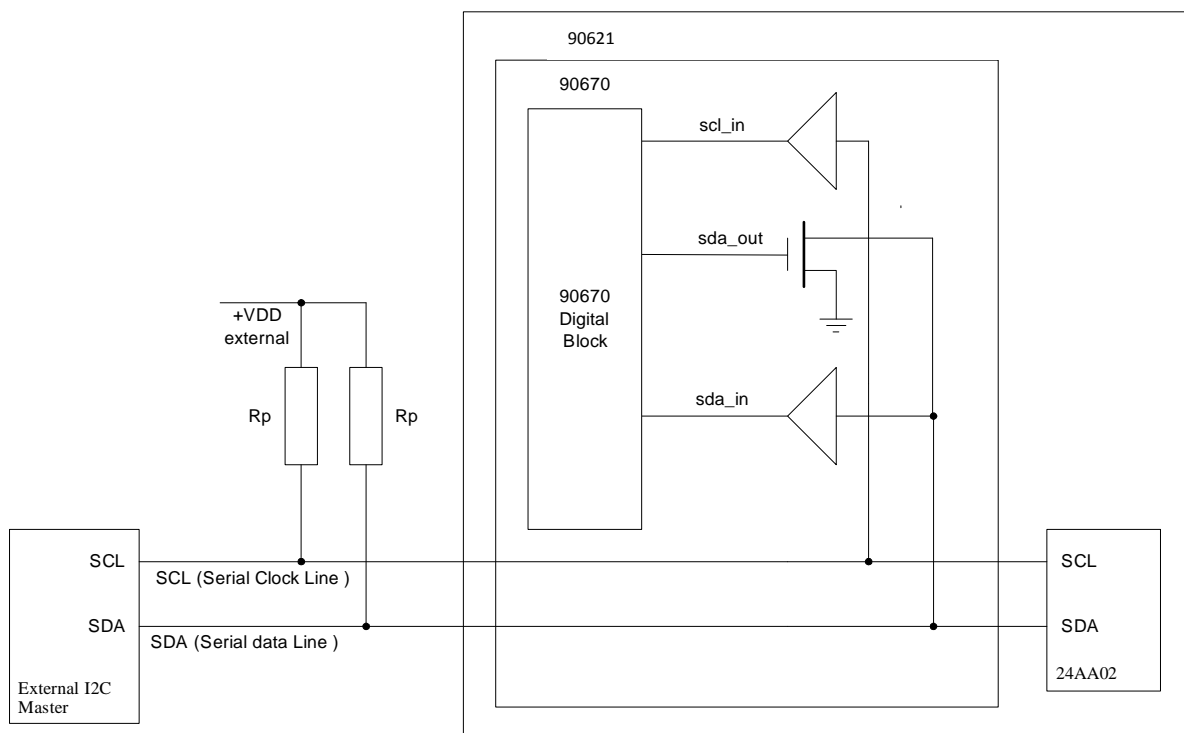

Figure 17 Communication pin diagram

9.2. Low level communication protocol

9.2.1. Start / Stop condition

Each communication session is initiated by a START condition and ends with a STOP condition. A START condition is initiated by a HIGH to LOW transition of the SDA while a STOP is generated by a LOW to HIGH transition. Both changes must be done while the SCL is HIGH (see the figure)

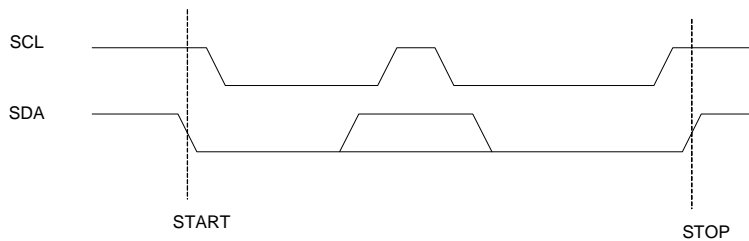

Figure 18: Start / Stop conditions of I²C

9.2.2. Device addressing

The master is addressing the slave device by sending a 7-bit slave address after the START condition. The first seven bits are dedicated for the address and the 8th is Read/Write (R/W) bit. This bit indicates the direction of the transfer:

- Read (HIGH) means that the master will read the data from the slave
- Write (LOW) means that the master will send data to the slave

Mlx90621 is responding to 2 different slave addresses:

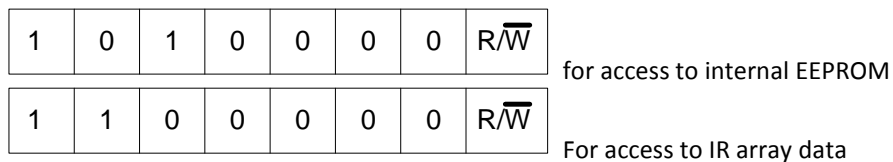

Figure 19: I²C addresses

9.2.3. Acknowledge

During the 9th clock following every byte transfer the transmitter releases the SDA line. The receiver acknowledges (ACK) receiving the byte by pulling SDA line to low or does not acknowledge (NoACK) by letting the SDA 'HIGH'.

9.2.4. Low level communication operation

The low level operation communication is based on 8bits (1byte) transmissions. This includes start/stop event, acknowledgement and errors detection.

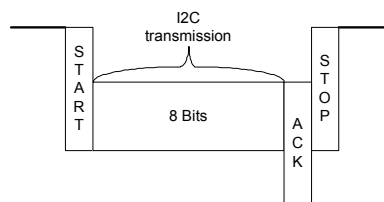

Figure 20: I²C communication

9.3. Device modes

The device can operate in following modes:

- Normal mode
- Step mode
- Power saving mode

9.3.1. Normal mode

In this mode the measurements are constantly running. Depending on the selected frame rate F_{ps} in the configuration register, the data for IR pixels and T_a will be updated in the RAM each $1/F_{ps}$ seconds. In this mode the external microcontroller has full access to the internal registers and memories of the device (both for 90670 and the EEPROM chip).

9.3.2. Step mode

This mode is foreseen for single measurements triggered by an external device (microcontroller). Entering this mode is possible by writing the appropriate code in the configuration register. A measurement is triggered by sending the command StartMeas (see 9.4.1). On detecting the command, the MLx90621 will start the measurements immediately after the I²C session is finished (STOP condition detected).

The measurement time is $\frac{1}{F_{ps}}$

While the Step mode measurement is ongoing all 'start new measurement in step mode' commands will be acknowledged but not executed. All other valid commands are executed accordingly.

A flag bit in Configuration register (bit 0x09) is dedicated in order to be able to check whenever the measurement is done.

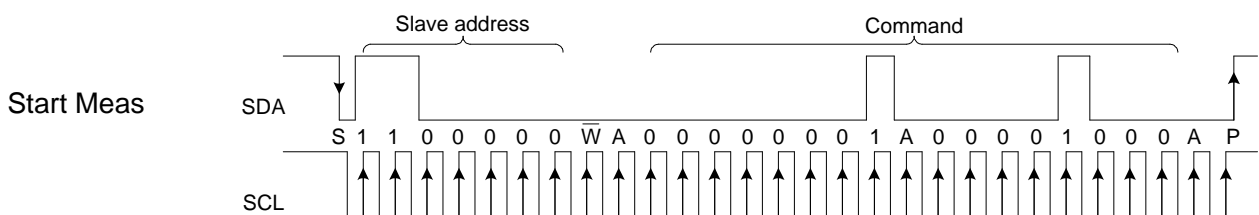

Figure 21 Write configuration register (SA = 0x60, command LSByte = 0x01 command MSByte = 0x08)

9.3.3. Power saving mode

In this mode the device will be completely shut down and the current consumption will be minimized to less than 6µA. Entering this mode is initiated by writing '1' in the configuration register bit 7. Upon receiving it the device will shut down all electronics, including the internal oscillator. The chip will monitor the I²C line. Each START condition will wake up the oscillator and the chip will receive and evaluate the slave address. If the address is 0x60 (address programmed in MLx90621) the device will evaluate the whole command and will execute it. If not, the oscillator will be switched off again.

9.4. Communication to IR array

9.4.1. Start measurement command

Opcode – 0x01 (LSByte), 0x08 (MSByte).

This command is used to start measurement cycle in step mode.

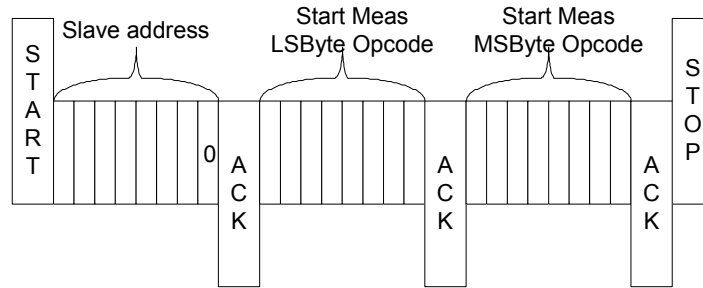

Figure 22: Start measurement command structure

9.4.2. Read command

Opcode – 0x02.

The read command is used to read measurement, configuration and other data from the chip to the external master.

The read command has the following parameters:

- Start address – 8bits. Address in the chip address space (0 to 255). It is the address of the first word read.
- Address step – 8bits. On every read word the next address is formed by adding the address step to the current address.
- Number of reads – 8bits. Number of the words to be read.

Different combinations are possible in order to read all, one line, one column, one exact pixel of the IR or Ta sensors. They are summarized in the table below:

Sensors read	Start address	Address step	Number of reads
All IR	0x00	0x01	0x40
One line IR(i)	i	0x04	0x10
One column IR(j)	j*0x04	0x01	0x04
One pixel IR(i,j)	i + j*0x04	0x00	0x01

Table 20 RAM readout options

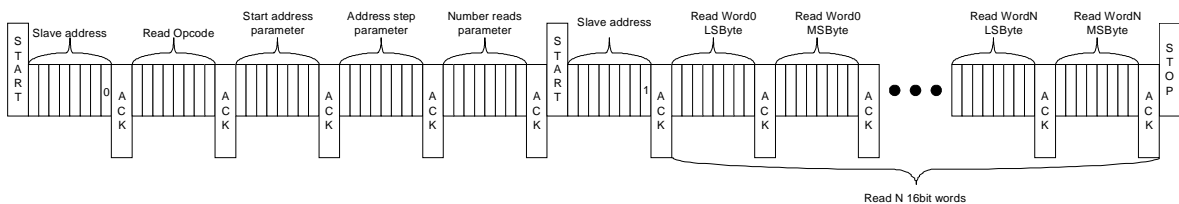

Figure 23: RAM readout command structure

9.4.3. Write configuration register command

Opcode – 0x03.

This command is used to set the configuration register (16bits) value – all configuration settings.
Each data byte is transmitted in two stages:

- First stage → Data byte - 0x55
- Second stage → Data byte

This way of transmitting the data is done in order to have a simple error check. The chip adds 0x55 to the first byte and compares the result with the second one. If both match the configuration register is updated.

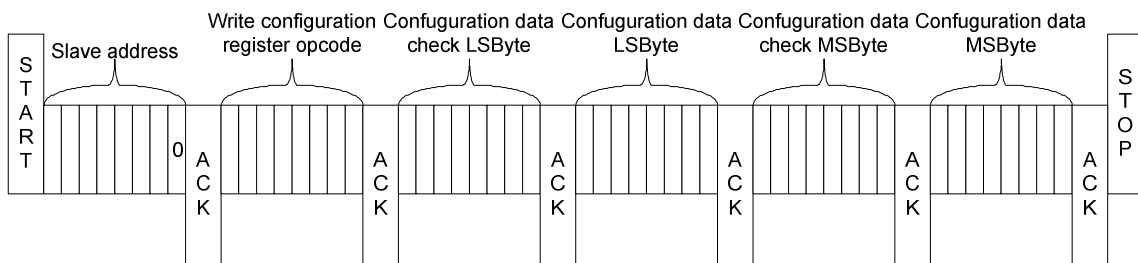

Figure 24: Configuration register update command structure

9.4.4. Write trimming command

Opcode – 0x04.

This command is used to set the oscillator trimming oscillator trimming value.

This command is used to set the oscillator trimming register (16bits) value.
Each data byte is transmitted in two stages:

- First stage → Data byte - 0xAA
- Second stage → Data byte

This way of transmitting the data is done in order to have a simple error check. The chip adds 0xAA to the first byte and compares the result with the second one. If both match the oscillator trimming register is updated.

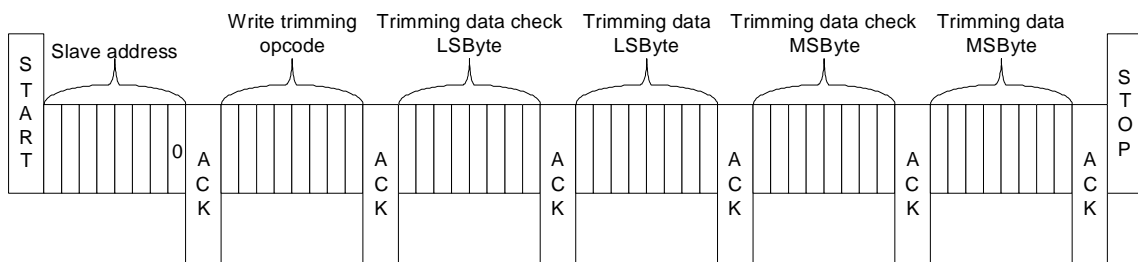

Figure 25: Oscillator trimming register update command structure

MLX90621

16x4 IR array

Datasheet



9.5. Communication to EEPROM

See datasheet of 24AA02. This can be found at

<https://www.melexis.com/en/product/mlx90621/far-infrared-sensor-array-high-speed-low-noise>

10. Performance Graphs

10.1. Temperature accuracy of the MLX90621

All accuracy specifications apply under settled isothermal conditions only.

Furthermore, the accuracy is only valid if the object fills the FOV of the sensor completely.

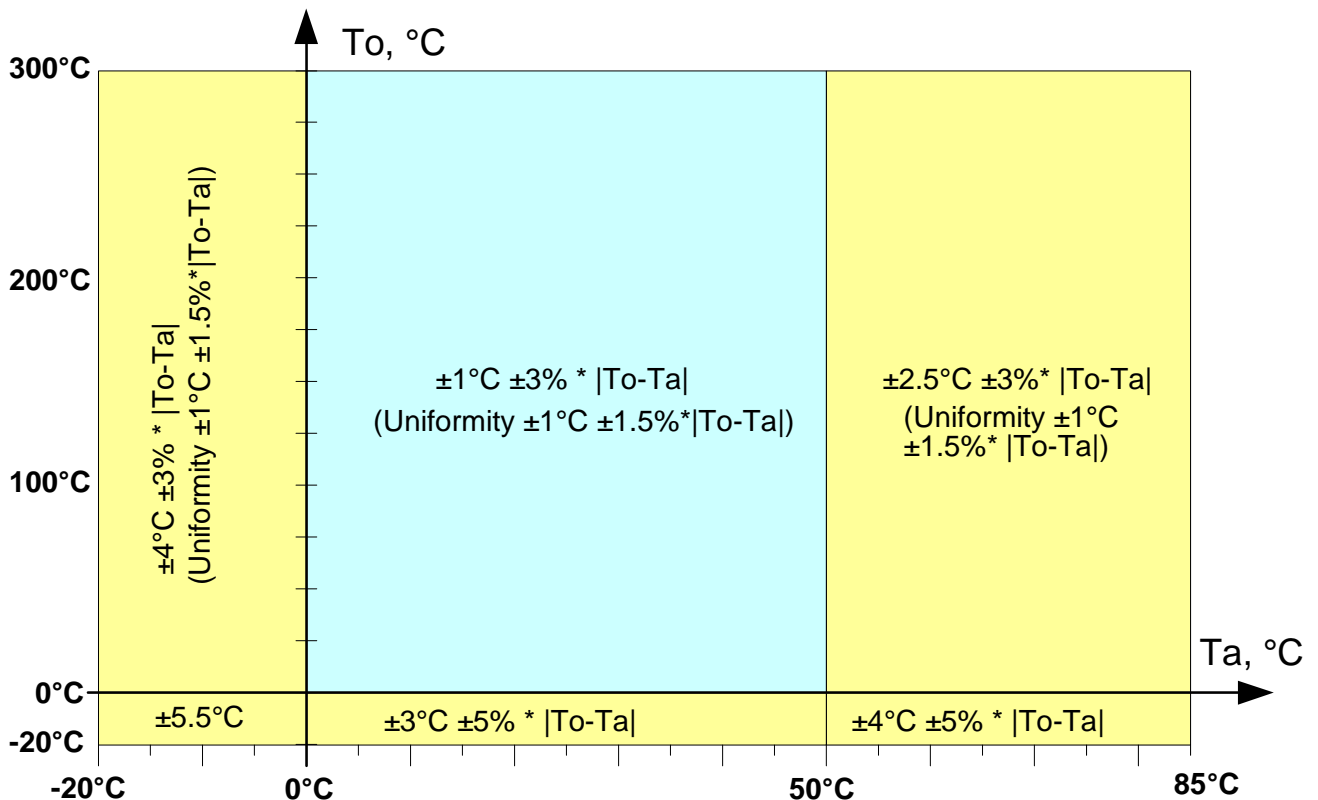

Figure 26: Absolute temperature accuracy for the central four pixels

All accuracy specifications apply under settled isothermal conditions only.

NOTE:

- 1) The accuracy is specified for the four central pixels. The accuracy of the rest of the pixels is according to the uniformity statement
- 2) As a result of long term (years) drift there can be an additional measurement deviation of $\pm 3^{\circ}\text{C}$ for object temperatures around room temperature.

10.2. Noise performance and resolution

There are two bits in the configuration register that allow changing the resolution of the MLX90621 measurements. Increasing the resolution decreases the quantization noise and improves the overall noise performance. Measurement conditions for the noise are: $T_o=T_a=25^{\circ}\text{C}$

NOTE: It is normal that the noise will decrease for high temperature and increase for lower temperatures

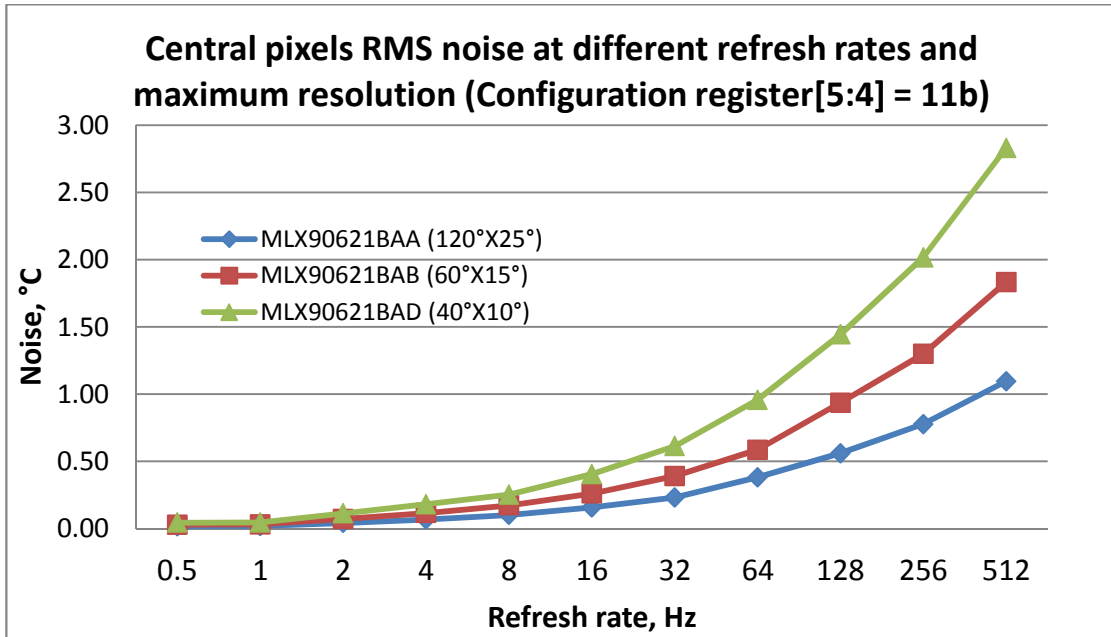

Figure 27: Central pixels noise

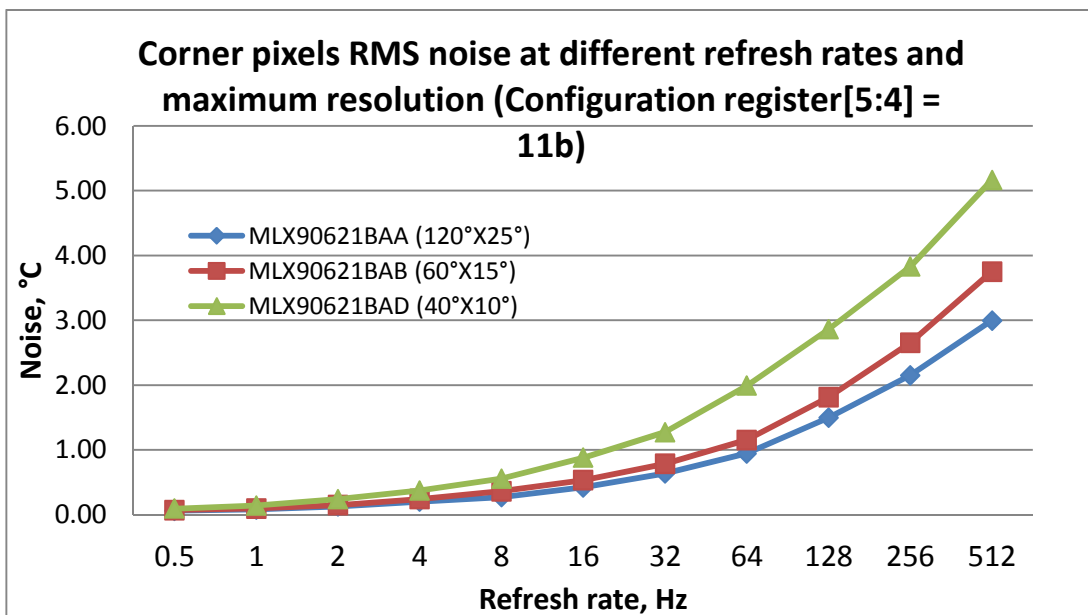

Figure 28: Corner pixels noise

The higher resolution limits the maximum object temperature range of the MLX90621.

Configuration register[5:4], bin	Resolution	Maximum object temperature, °C		
		BAA	BAB	BAD
00	15 bits	~750	~950	~1100
01	16 bits	~550	~750	~900
10	17 bits	~450	~600	~700
11	18 bits	~320	~450	~500

Table 21 Maximum object temperature at different resolution settings

NOTE: If object temperature exceeds the maximum object temperature specified for the corresponding resolution, the MLX90621 may return invalid data due to measurements overflow.

10.3. Field Of View (FOV)

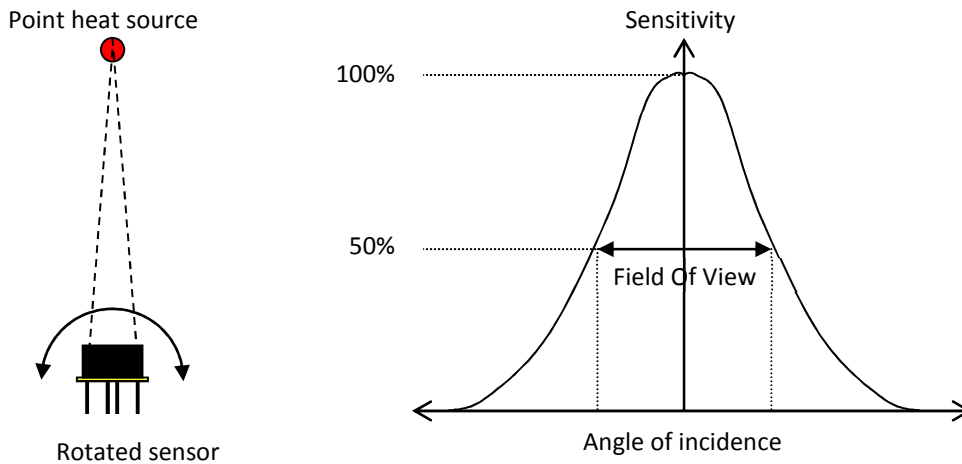

Figure 29: Field Of View measurement

The specified FOV is calculated for the wider direction, in this case for the 16 pixels.

Angular alignment must be 5% of specified FOV and will be valid for both directions. For example for the 60° FOV in the wider direction will come with 16° in the shorter direction.

FOV	X direction	Y direction
	Typ	Typ
MLX90621-ESF-BAA	120	25
MLX90621-ESF-BAB	60	16
MLX90621-ESF-BAD	40	10

Table 22 Available FOV options

11. Applications Information

11.1. Use of the MLX90621 thermometer in I²C configuration

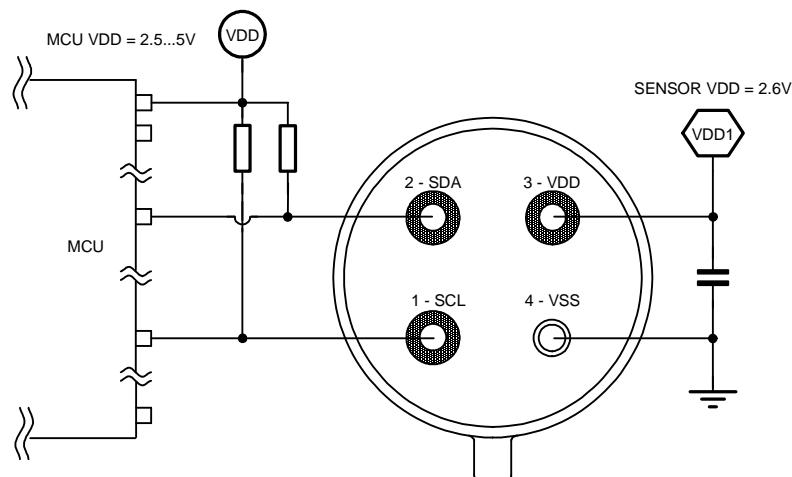

Figure 30: MLX90621 I²C connection

As the MLX90621xxx is fully I²C compatible it allows to have a system in which the MCU may be supplied with VDD=2.5...5V while the sensor it's self is supplied from separate supply VDD1=2.6V (or even left with no supply i.e. VDD=0V), **with the I²C connection running at supply voltage of the MCU.**

12. Application Comments

Significant **contamination** at the optical input side (sensor filter) might cause unknown additional filtering/distortion of the optical signal and therefore result in unspecified errors.

IR sensors are inherently susceptible to errors caused by **thermal gradients**. There are physical reasons for these phenomena and, in spite of the careful design of the MLX90621xxx, it is recommended not to subject the MLX90621 to heat transfer and especially transient conditions.

The MLX90621 is designed and calibrated to operate as a non-contact thermometer in **settled conditions**. Using the thermometer in a very different way will result in unknown results.

Capacitive loading on an I²C can degrade the communication. Some improvement is possible with use of current sources compared to resistors in pull-up circuitry. Further improvement is possible with specialized commercially available bus accelerators. With the MLX90621 additional improvement is possible by increasing the pull-up current (decreasing the pull-up resistor values). Input levels for I²C compatible mode have higher overall tolerance than the I²C specification, but the output low level is rather low even with the high-power I²C specification for pull-up currents. Another option might be to go for a slower communication (clock speed), as the MLX90621 implements Schmidt triggers on its inputs in I²C compatible mode and is therefore not really sensitive to rise time of the bus (it is more likely the rise time to be an issue than the fall time, as far as the I²C systems are open drain with pull-up).

MLX90621

16x4 IR array

Datasheet



Power dissipation within the package may affect performance in two ways: by heating the “ambient” sensitive element significantly beyond the actual ambient temperature, as well as by causing gradients over the package that will inherently cause thermal gradient over the cap

Power supply decoupling capacitor is needed as with most integrated circuits. MLX90621 is a mixed-signal device with sensors, small signal analog part, digital part and I/O circuitry. In order to keep the noise low power supply switching noise needs to be decoupled. High noise from external circuitry can also affect noise performance of the device. In many applications a 100nF SMD ceramic capacitor close to the Vdd and Vss pins would be a good choice. It should be noted that not only the trace to the Vdd pin needs to be short, but also the one to the Vss pin. Using MLX90621 with short pins improves the effect of the power supply decoupling.

Check www.melexis.com for most recent application notes about MLX90621.

13. Standard information regarding manufacturability of Melexis products with different soldering processes

Our products are classified and qualified regarding soldering technology, solderability and moisture sensitivity level according to following test methods:

Wave Soldering THD's (Through Hole Devices)

- EIA/JEDEC JESD22-B106 and EN60749-15
Resistance to soldering temperature for through-hole mounted devices

Iron Soldering THD's (Through Hole Devices)

- EN60749-15
Resistance to soldering temperature for through-hole mounted devices

Solderability THD's (Through Hole Devices)

- EIA/JEDEC JESD22-B102 and EN60749-21
Solderability

For all soldering technologies deviating from above mentioned standard conditions (regarding peak temperature, temperature gradient, temperature profile etc) additional classification and qualification tests have to be agreed upon with Melexis.

Melexis is contributing to global environmental conservation by promoting **lead free** solutions. For more information on qualifications of **RoHS** compliant products (RoHS = European directive on the Restriction Of the use of certain Hazardous Substances) please visit the quality page on our website: <http://www.melexis.com/quality.aspx>

The MLX90621 is RoHS compliant

14. ESD Precautions

Electronic semiconductor products are sensitive to Electro Static Discharge (ESD). Always observe Electro Static Discharge control procedures whenever handling semiconductor products.

15. FAQ

When I measure aluminum and plastic parts settled at the same conditions I get significant errors on aluminum. Why?

Different materials have different **emissivity**. A typical value for aluminum (roughly polished) is 0.18 and for plastics values of 0.84...0.95 are typical. IR thermometers use the radiation flux between the sensitive element in the sensor and the object of interest, given by the equation

$$q = \varepsilon_1 * \alpha_1 * T_1^4 * \sigma * A_1 * F_{a-b} - \varepsilon_2 * T_2^4 * \sigma * A_2$$

Where:

ε_1 and ε_2 are the emissivity of the two objects

α_1 is the absorptivity of the sensor (in this case),

σ is the the Stefan-Boltzmann constant,

A_1 and A_2 are the surface areas involved in the radiation heat transfer,

F_{A-B} is the shape factor,

T_1 and T_2 are known temperature of the sensor die (measured with specially integrated and calibrated element) and the object temperature that we need.

Note that the temperatures are all in Kelvin, heat exchange knows only physics.

When a body with low emissivity (such as aluminum) is involved in this heat transfer, the portion of the radiation incident to the sensor element that really comes from the object of interest decreases – and the reflected environmental IR emissions take place. (This is all for bodies with zero transparency in the IR band.) The IR thermometer is calibrated to stay within specified accuracy – but it has no way to separate the incoming IR radiation into real object and reflected environmental part. Therefore, measuring objects with low emissivity is a very sophisticated issue and infra-red measurements of such materials are a specialized field.

What can be done to solve that problem? Look at paintings – for example, oil paints are likely to have emissivity of 0.85...0.95 – but keep in mind that the stability of the paint emissivity has inevitable impact on measurements. It is also a good point to keep in mind that not everything that looks black is “black” also for IR. For example, even heavily oxidized aluminum has still emissivity as low as 0.30.

How high is enough? Not an easy question – but, in all cases the closer you need to get to the real object temperature the higher the needed emissivity will be, of course.

With the real life emissivity values the environmental IR comes into play via the reflectivity of the object (the sum of Emissivity, Reflectivity and Absorptivity gives 1.00 for any material). The larger the difference between environmental and object temperature is at given reflectivity (*with an opaque for IR material reflectivity equals 1.00 minus emissivity*) the bigger errors it produces.

After I put the MLX90621 in the dashboard I start getting errors larger than specified in spite that the module was working properly before that. Why?

Any object present in the FOV of the module provides IR signal. It is actually possible to introduce error in the measurements if the module is attached to the dashboard with an opening that enters the FOV. In that case portion of the dashboard opening will introduce IR signal in conjunction with constraining the effective FOV and thus compromising specified accuracy. Relevant opening that takes in account the FOV is a must for accurate

MLX90621

16x4 IR array

Datasheet

measurements. Note that the basic FOV specification takes 50% of IR signal as threshold (in order to define the area, where the measurements are relevant), while the entire FOV at lower level is capable of introducing lateral IR signal under many conditions.

When a hot (cold) air stream hits my MLX90621 some error adds to the measured temperature I read. What is it?

IR sensors are inherently sensitive to difference in temperatures between the sensitive element and everything incident to that element. As a matter of fact, this element is not the sensor package, but the sensor die inside. Therefore, a thermal gradient over the sensor package will inevitably result in additional IR flux between the sensor package and the sensor die. This is real optical signal that cannot be segregated from the target IR signal and will add errors to the measured temperature.

Thermal gradients with impact of that kind are likely to appear during transient conditions. The sensor used is developed with care about sensitivity to this kind of lateral phenomena, but their nature demands some care when choosing place to use the MLX90621 in order to make them negligible.

I measure human body temperature and I often get measurements that significantly differ from the +37°C I expect.

IR measurements are true surface temperature measurements. In many applications this means that the actual temperature measured by an IR thermometer will be temperature of the clothing and not the skin temperature.

Emissivity (explained first in this section) is another issue with clothes that has to be considered.

There is also the simple chance that the measured temperature is adequate – for example, in a cold winter human hand can appear at temperatures not too close to the well-known +37°C.

16. Mechanical specification

16.1. Package outline

The height of the can depends on the selected FOV of the array

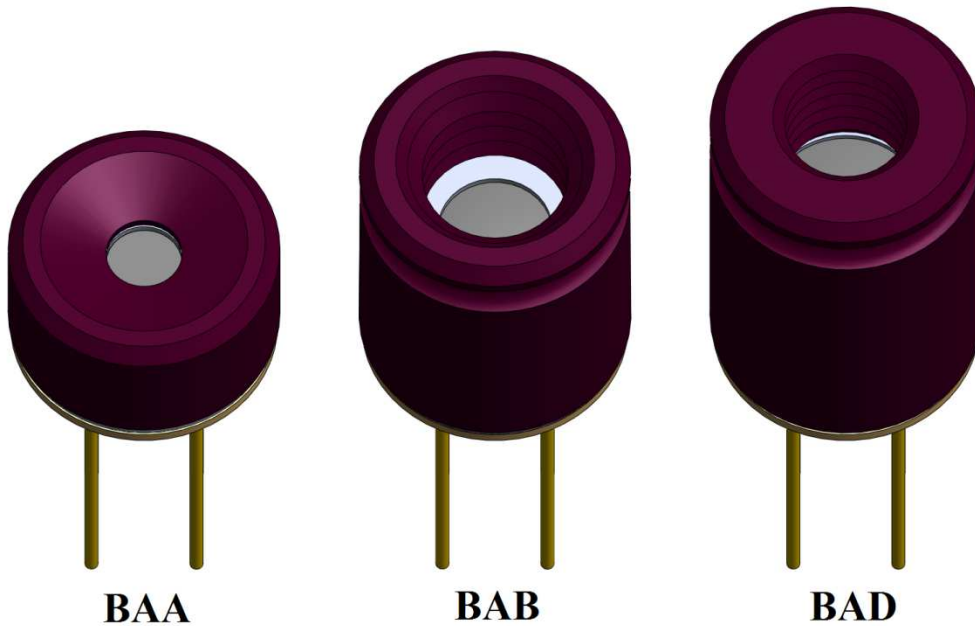

Figure 31 Overview of the different device FOV options

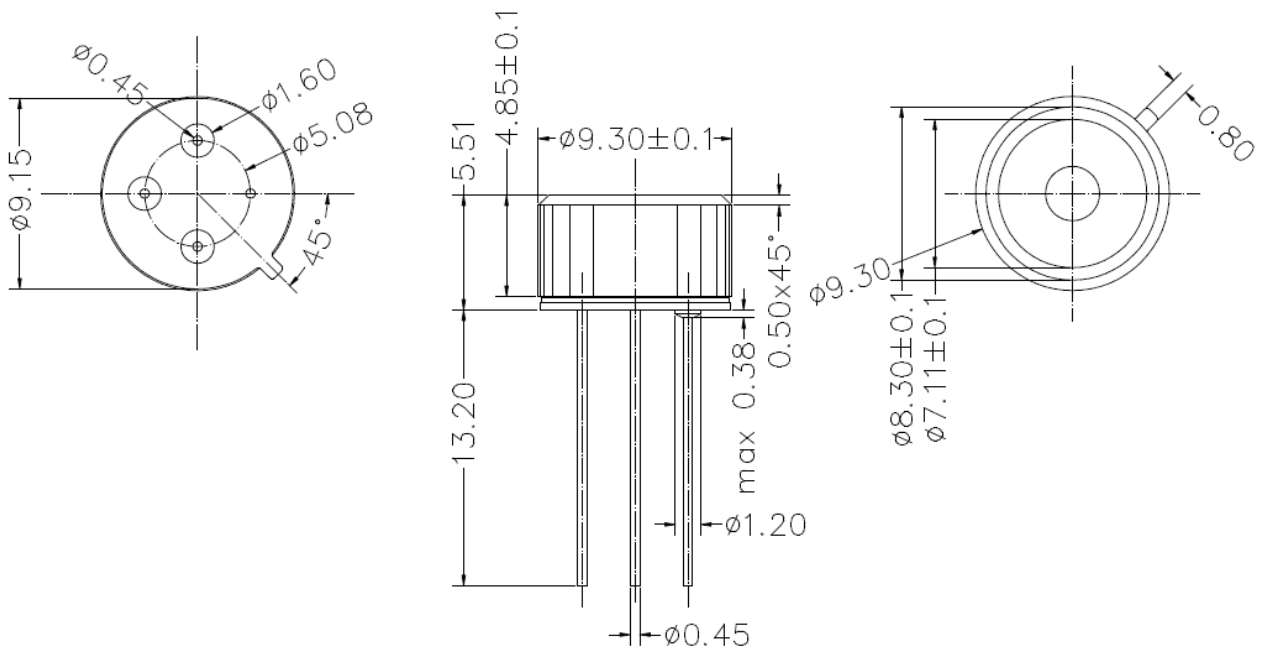

Figure 32 Mechanical drawing of Wide (120x25) FOV device (MLX90621BAA)

MLX90621

16x4 IR array

Datasheet

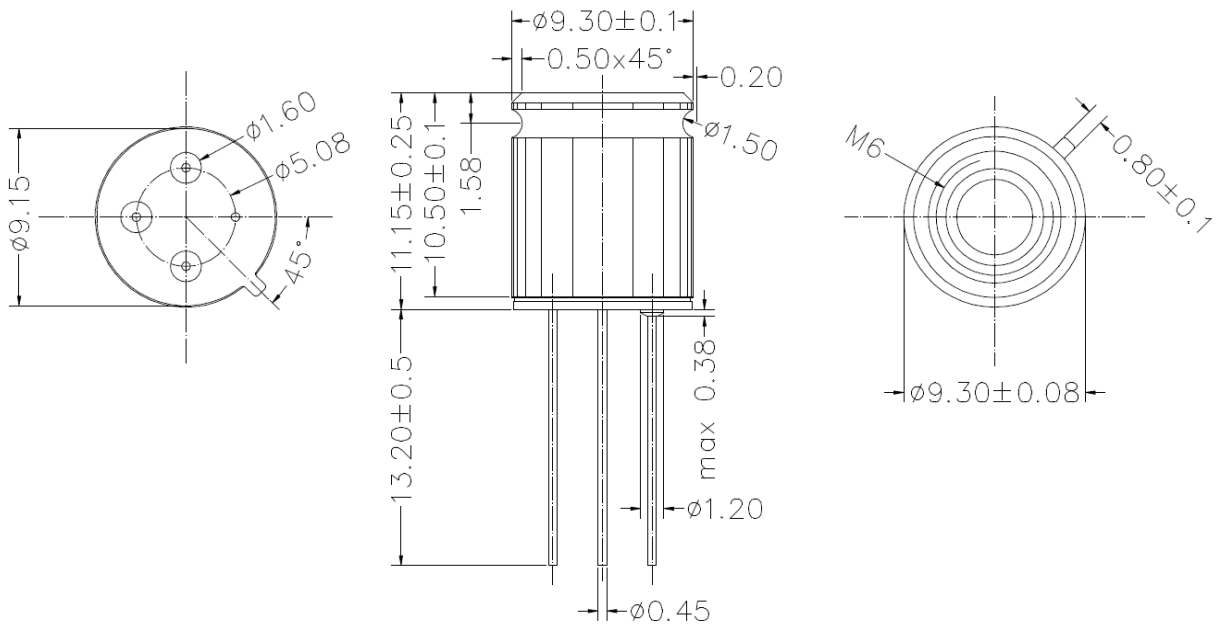

Figure 33 Mechanical drawing of Wide (60x16) FOV device (MLX90621BAB)

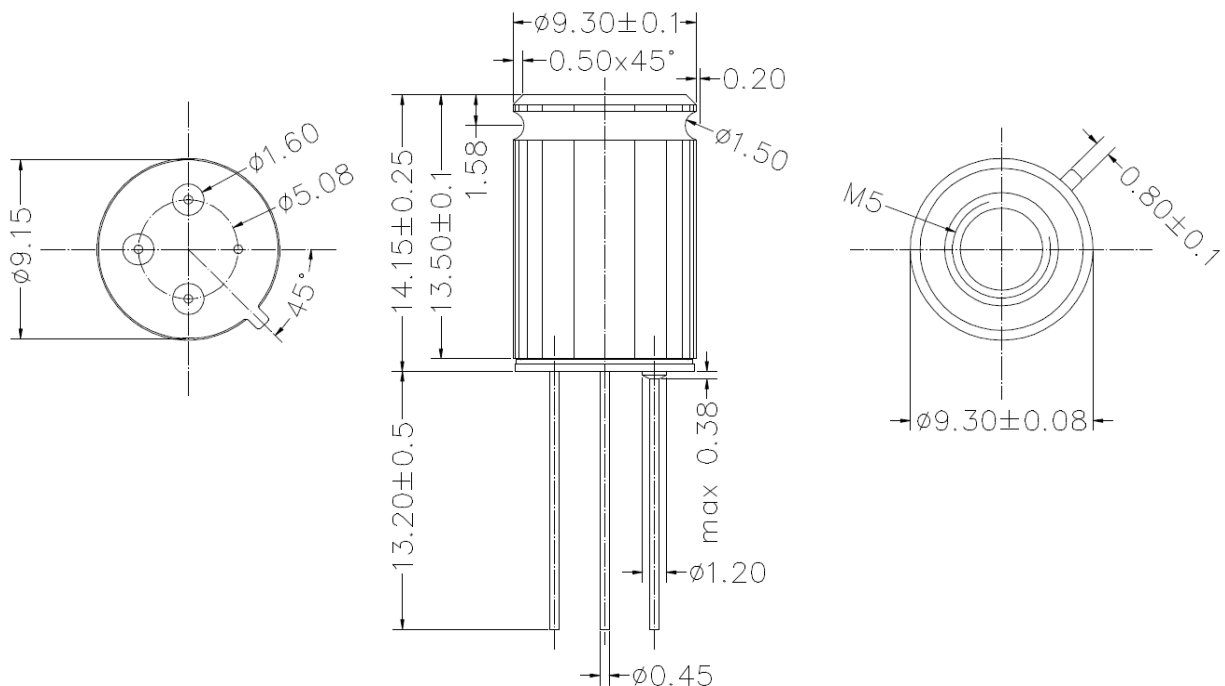

Figure 34 Mechanical drawing of Medium (40x10) FOV device (MLX90621BAD)

16.2. Part marking

The MLX90621 is laser marked with 10 symbols. The first is a 1, the next 3 letters indicate the version (BAA, BAB or BAD) and the remaining 7 indicate the lot number.

17. References

[1] I²C-bus specification and user manual Rev. 03 — 19 June 2007

http://www.nxp.com/documents/user_manual/UM10204.pdf

18. Disclaimer

Devices sold by Melexis are covered by the warranty and patent indemnification provisions appearing in its Term of Sale. Melexis makes no warranty, express, statutory, implied, or by description regarding the information set forth herein or regarding the freedom of the described devices from patent infringement. Melexis reserves the right to change specifications and prices at any time and without notice. Therefore, prior to designing this product into a system, it is necessary to check with Melexis for current information. This product is intended for use in normal commercial applications. Applications requiring extended temperature range, unusual environmental requirements, or high reliability applications, such as military, medical life-support or life-sustaining equipment are specifically not recommended without additional processing by Melexis for each application.

The information furnished by Melexis is believed to be correct and accurate. However, Melexis shall not be liable to recipient or any third party for any damages, including but not limited to personal injury, property damage, loss of profits, loss of use, interrupt of business or indirect, special incidental or consequential damages, of any kind, in connection with or arising out of the furnishing, performance or use of the technical data herein. No obligation or liability to recipient or any third party shall arise or flow out of Melexis' rendering of technical or other services.

© 2015 Melexis NV. All rights reserved.

For the latest version of this document, go to our website at

www.melexis.com

Or for additional information contact Melexis Direct:

Europe, Africa, Asia:

Phone: +32 1367 0495

E-mail: sales_europe@melexis.com

America:



Phone: +1 248 306 5400

E-mail: sales_usa@melexis.com





ISO/TS 16949 and ISO14001 Certified

Looking for pricing, stock, or lifecycle information?

Click below to explore more details on WIN SOURCE:

-  [View MLX90621ESF-BAB-000-TU on WIN SOURCE](#)
-  [Melexis Technologies NV Information](#)

Optimize Your Supply Chain with WIN SOURCE Solutions

-  Global Sourcing Solution
-  Obsolete Management
-  Cost Control Management
-  Shortage Management
-  Alternative Solution
-  Excess Inventory Management