



**THE DATASHEET OF  
YNA21B2J0G106M**





# Noise Absorber

Controlled ESR Type

## YNA series

---

<b>YNA15</b>	<b>1005 [0402 inch]</b>
<b>YNA18</b>	<b>1608 [0603 inch]</b>
<b>YNA21</b>	<b>2012 [0805 inch]</b>

\* Dimensions Code JIS[EIA]

---

# Noise Absorber

## Controlled ESR Type

Conformity to RoHS Directive  
Lead-free Compatible

# Overview of YNA Series

## FEATURES

- The special laminated interior structure means ESR values can be controlled.
- An impedance waveform with no pole means anti-resonance is controlled.
- Without decreasing power efficiency, EMI measures can be taken.

## APPLICATIONS

Countermeasures against ringing of switching power supply for smart phones, tablet PCs, etc.  
Countermeasures against anti-resonance of impedance inside a decoupling circuit

## PART NUMBER IDENTIFICATION

Series name	LxW Dimensions (mm)	Product internal code	ESR value*	Rated voltage (V)	Capacitance (pF)	Tolerance	Taping	TDK internal code	Reel size (mm)	Internal electrode Ni
YNA	15	B	1J	0G	105	M	T	□□	0	N
	1.0x0.5	2-terminal (with NC terminal)		4	1,000,000 (1.0μF)	±20%			ø178	
	1.6x0.8	(NC: Not Connected)			10,000,000 (10μF)				ø330	
	2.0x1.2									

\* An ESR value is shown in two characters with a mΩ unit. The first digit is the multiplier of the ESR value: 1: 10, 2: 100, and 3: 1000. The second digit shows the significant figure of the ESR value. A: 1.0, B: 1.5, C: 2.0, D: 2.5, E: 3.0, F: 3.5, G: 4.0, H: 4.5, J: 5.0, K: 5.5, L: 6.0, M: 6.5, N: 7.0, P: 7.5, Q: 8.0, R: 8.5, S: 9.0, T: 9.5, U: 1.2

## SPECIFICATIONS

Type	Specifications	
	Operating temperature range	Storage temperature range (After mount)
YNA15	-55 to +85	-55 to +85
YNA18	-55 to +85	-55 to +85
YNA21	-55 to +85	-55 to +85

## PACKAGING STYLE AND SPECIFICATIONS

Type	Package quantity (piece/reel)		Single weight (g)
	ø178	ø330	
YNA15	10,000	50,000	0.0008
YNA18	4,000	10,000	0.0051
YNA21	4,000	10,000	0.0095

- Conformity to RoHS Directive: This means that, in conformity with EU Directive 2002/95/EC, lead, cadmium, mercury, hexavalent chromium, and specific bromine-based flame retardants, PBB and PBDE, have not been used, except for exempted applications.
- Please contact our Sales office when your application is considered the following:  
The device's failure or malfunction may directly endanger human life (e.g. application for automobile/aircraft/medical/nuclear power devices, etc.)

 Please be sure to request delivery specifications that provide further details on the features and specifications of the products for proper and safe use. Please note that the contents may change without any prior notice due to reasons such as upgrading.

# Overview of YNA Series

## RECOMMENDED SOLDERING CONDITION

### REFLOW SOLDERING

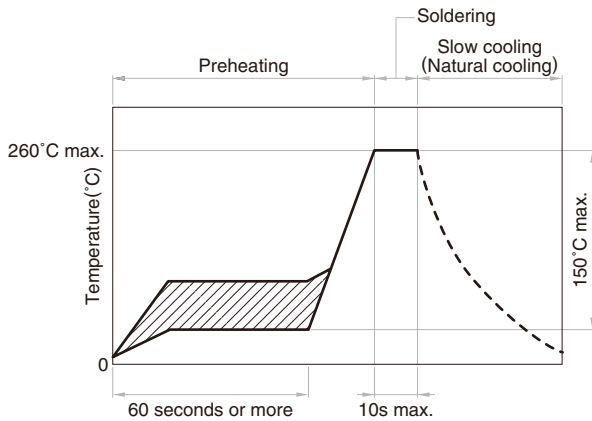

### HAND SOLDERING

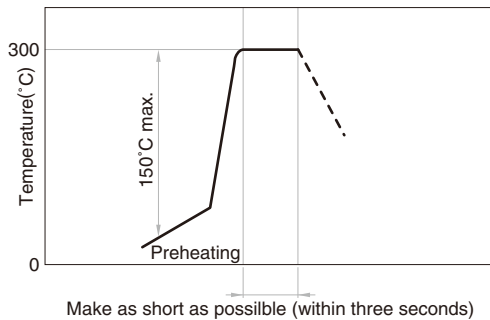

## PRECAUTIONS FOR USE

- Before soldering, be sure to preheat components. The  $\Delta T$  preheating temperature must be 150°C max. with attention paid to thermal shock.
- Natural cooling of components in the air is recommended. On the other hand, when dipping them in a solvent for purposes, such as cleaning, make sure that the temperature difference ( $\Delta T$ ) is 100°.
- When performing hand soldering for circuit modification, apply the soldering iron to the copper foil area of the printed circuit board for 3 seconds or less. The temperature of the iron tip should not exceed 300°C.
- Use a wrist band to discharge static electricity in your body through the grounding wire.
- When incorporating the printed circuit board on which this product is mounted into a frame, etc., do not apply stress to the product through local bending of the board by tightening of screws, etc.

YNA Series **YNA15 Type**

## ■ SHAPES AND DIMENSIONS

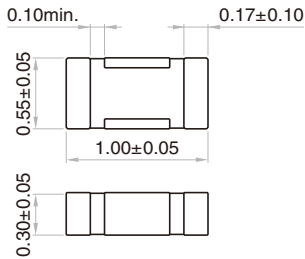

## ■ RECOMMENDED LAND PATTERN

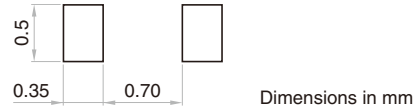

The lateral terminals are not connected.

## ■ ELECTRICAL CHARACTERISTICS

## □ CHARACTERISTICS SPECIFICATION TABLE

Part No.	Capacitance (μF)	Tolerance (%)	Rated voltage Edc (V)	ESR (mΩ)
YNA15B1J0G105MT00□N*	1	20	4	50 (±30%)
YNA15B2A0G105MT00□N	1	20	4	100 (±30%)
YNA15B2C0G105MT00□N	1	20	4	200 (±30%)
YNA15B2J0G105MT00□N	1	20	4	500 (±30%)
YNA15B3A0G105MT00□N	1	20	4	1000 (±30%)

\* Any ESR value can be set if it is the same as or smaller than the maximum ESR value. Contact us if you need an ESR value other than ones shown in the table.

\* □: Please specify reel size code, 0 (ø178) or 9 (ø330)

## ■ ELECTRICAL CHARACTERISTICS GRAPH (EXAMPLE)

## □ IMPEDANCE vs. FREQUENCY CHARACTERISTICS

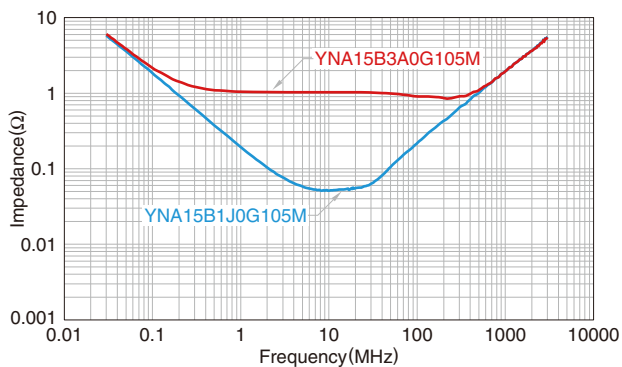

## □ ATTENUATION vs. FREQUENCY CHARACTERISTICS

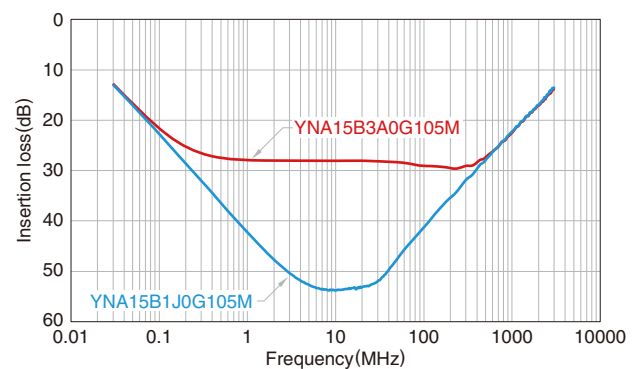

# YNA Series YNA18 Type

## SHAPES AND DIMENSIONS

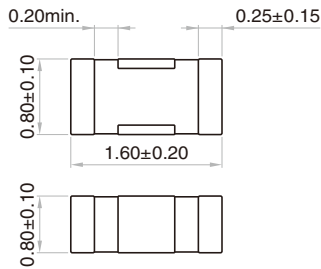

## RECOMMENDED LAND PATTERN

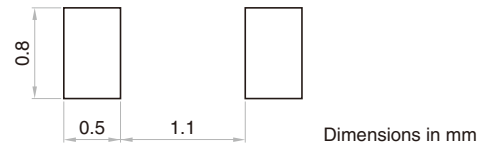

The lateral terminals are not connected.

## ELECTRICAL CHARACTERISTICS

### CHARACTERISTICS SPECIFICATION TABLE

Part No.	Capacitance (μF)	Tolerance (%)	Rated voltage Edc (V)	ESR (mΩ)
YNA18B1J0G105MT00□N*	1	20	4	50 (±30%)
YNA18B2A0G105MT00□N	1	20	4	100 (±30%)
YNA18B2C0G105MT00□N	1	20	4	200 (±30%)
YNA18B2J0G105MT00□N	1	20	4	500 (±30%)
YNA18B3U0G105MT00□N	1	20	4	1200 (±30%)

\* Any ESR value can be set if it is the same as or smaller than the maximum ESR value. Contact us if you need an ESR value other than ones shown in the table.

\* □: Please specify reel size code, 0 (ø178) or 9 (ø330)

## ELECTRICAL CHARACTERISTICS GRAPH (EXAMPLE)

### IMPEDANCE vs. FREQUENCY CHARACTERISTICS

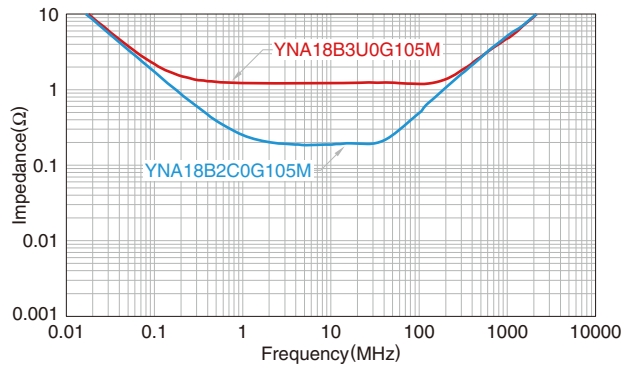

### ATTENUATION vs. FREQUENCY CHARACTERISTICS

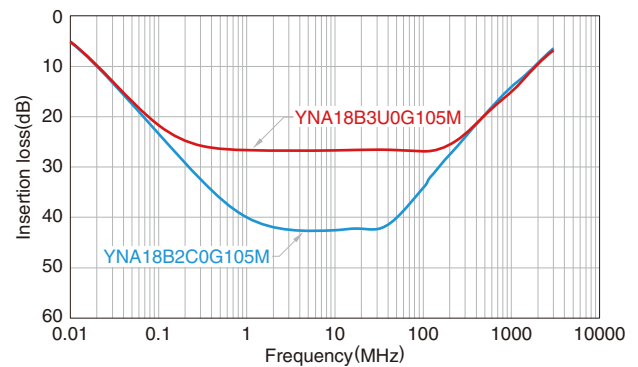

# YNA Series YNA21 Type

## SHAPES AND DIMENSIONS

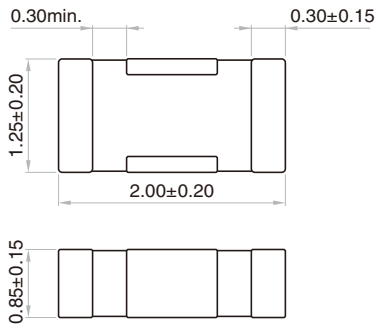

## RECOMMENDED LAND PATTERN

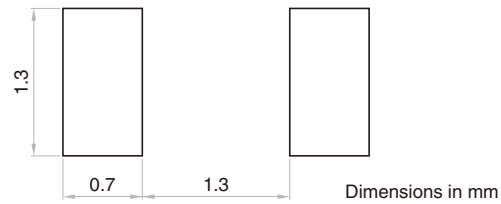

The lateral terminals are not connected.

## ELECTRICAL CHARACTERISTICS

### CHARACTERISTICS SPECIFICATION TABLE

Part No.	Capacitance ( $\mu\text{F}$ )	Tolerance (%)	Rated voltage $E_{dc}$ (V)	ESR ( $\text{m}\Omega$ )
YNA21B1J0G106MT00□N*	10	20	4	50 ( $\pm 30\%$ )
YNA21B2A0G106MT00□N	10	20	4	100 ( $\pm 30\%$ )
YNA21B2C0G106MT00□N	10	20	4	200 ( $\pm 30\%$ )
YNA21B2J0G106MT00□N	10	20	4	500 ( $\pm 30\%$ )

\* Any ESR value can be set if it is the same as or smaller than the maximum ESR value. Contact us if you need an ESR value other than ones shown in the table.

\* □: Please specify reel size code, 0 ( $\phi 178$ ) or 9 ( $\phi 330$ )

## ELECTRICAL CHARACTERISTICS GRAPH (EXAMPLE)

### IMPEDANCE vs. FREQUENCY CHARACTERISTICS

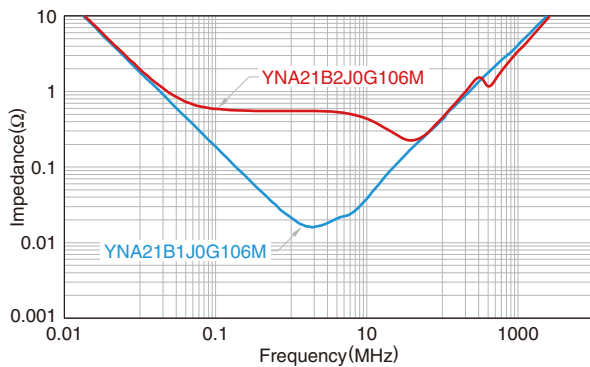

### ATTENUATION vs. FREQUENCY CHARACTERISTICS

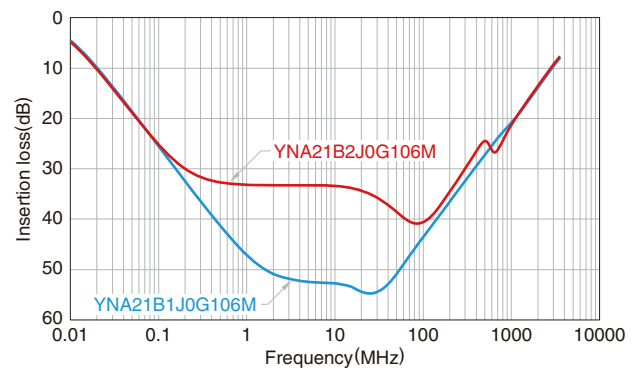

Please be sure to request delivery specifications that provide further details on the features and specifications of the products for proper and safe use. Please note that the contents may change without any prior notice due to reasons such as upgrading.

YNA series

# Packaging Style

## REEL DIMENSIONS

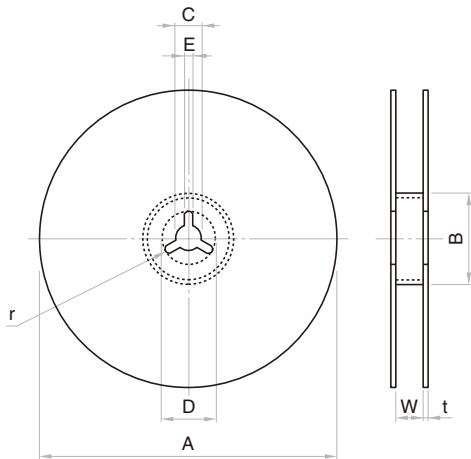

Dimensions in mm

Reel	A	B	C	D	E	W	t	r
ø178	ø178±2.0	ø60±2.0	ø13±0.5	ø21±0.8	2.0±0.5	9.0±0.3	2.0±0.5	1.0
ø330	ø382 max.(ø330 nom.)	ø50 min.	ø13±0.5	ø21±0.8	2.0±0.5	10.0±1.5	2.0±0.5	1.0

## TAPE DIMENSIONS

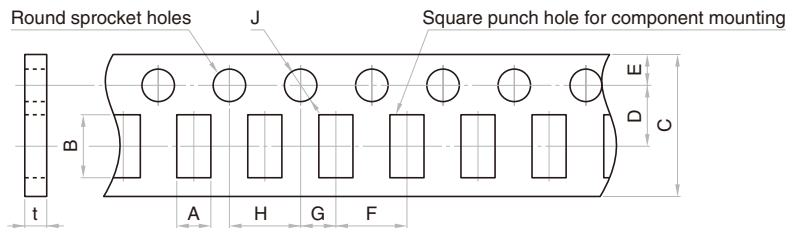



Dimensions in mm

Type	A	B	C	D	E	F	G	H	J	t
YNA15	0.65 typ.	1.15 typ.	8.00±0.30	3.50±0.05	1.75±0.10	2.00±0.05	2.00±0.05	4.00±0.10	ø1.50+0.10/-0	0.70 max.
YNA18	1.10 typ.	1.90 typ.	8.00±0.30	3.50±0.05	1.75±0.10	4.00±0.10	2.00±0.05	4.00±0.10	ø1.50+0.10/-0	1.20 max.
YNA21	1.50 typ.	2.30 typ.	8.00±0.30	3.50±0.05	1.75±0.10	4.00±0.10	2.00±0.05	4.00±0.10	ø1.50+0.10/-0	1.20 max.

**!** Please be sure to request delivery specifications that provide further details on the features and specifications of the products for proper and safe use. Please note that the contents may change without any prior notice due to reasons such as upgrading.

## Looking for pricing, stock, or lifecycle information?

Click below to explore more details on WIN SOURCE:

-  [View YNA21B2J0G106M on WIN SOURCE](#)
-  [TDK Corporation Information](#)

## Optimize Your Supply Chain with WIN SOURCE Solutions

-  Global Sourcing Solution
-  Obsolete Management
-  Cost Control Management
-  Shortage Management
-  Alternative Solution
-  Excess Inventory Management