



# THE DATASHEET OF MAX6125EUR-T



# MAX6125/MAX6141/ MAX6145/MAX6150/MAX6160

# SOT23, Low-Cost, Low-Dropout, 3-Terminal Voltage References

## General Description

The MAX6125/MAX6141/MAX6145/MAX6150/MAX6160 low-dropout, micropower, three-terminal voltage references offer 2.5V, 4.096V, 4.5V, 5.0V, and adjustable (1.23V to 12.4V) output voltages, respectively. Low, 200mV dropout makes these devices ideal for 3V and 5V systems. Unlike two-terminal references that waste battery current and require an external resistor, the MAX61xx family's supply current is virtually independent of input voltage variations, which translates to longer battery life.

Initial accuracy for these devices is  $\pm 1\%$ . The output temperature coefficient is typically 15ppm/ $^{\circ}\text{C}$ , and guaranteed to be less than 50ppm/ $^{\circ}\text{C}$  (except for the MAX6160). The MAX6125/MAX6141/MAX6145/MAX6150 are available in 3-pin SOT23 and 8-pin SO packages. The MAX6160 is available in 4-pin SOT143 and 8-pin SO packages.

## Selector Guide

PART	PRESET OUTPUT VOLTAGE (V)	PIN-PACKAGE
MAX6125	2.5	3 SOT23/8 SO
MAX6141	4.096	3 SOT23/8 SO
MAX6145	4.5	3 SOT23/8 SO
MAX6150	5	3 SOT23/8 SO
MAX6160	Adjustable (1.23 to 12.40)	4 SOT143/8 SO

Typical Operating Circuit appears on last page.

## Pin Configurations

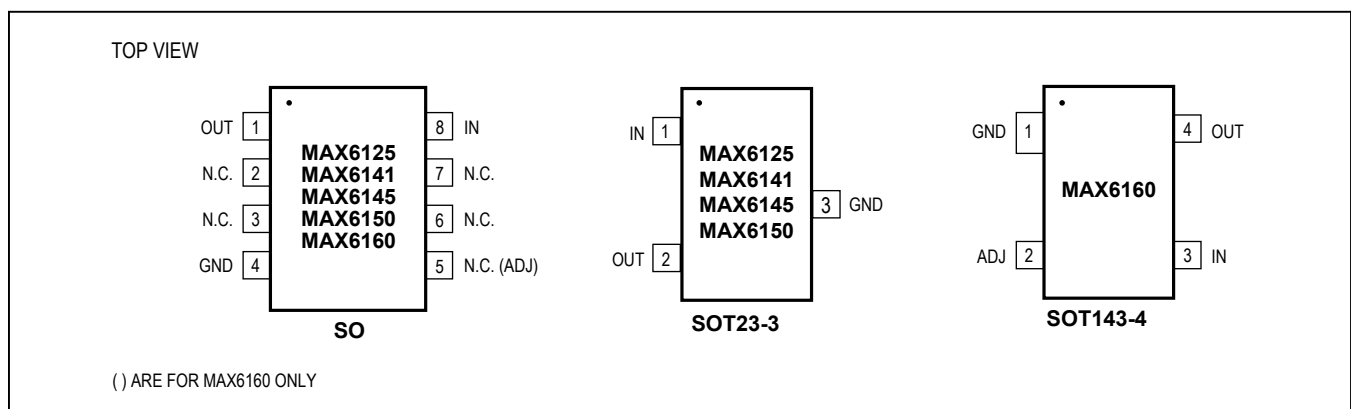

## Features

- 3-Pin SOT23 Package (MAX6125/MAX6141/MAX6145/MAX6150)
- 4-Pin SOT143 Package (MAX6160)
- Low, 200mV Dropout Voltage
- 75 $\mu\text{A}$  Supply Current, Independent of Input Voltage
- 15ppm/ $^{\circ}\text{C}$  Typical Tempco (50ppm/ $^{\circ}\text{C}$ , max)
- Stable for All Capacitive Loads up to 10nF
- Adjustable Output Voltage from 1.23V to  $(V_{\text{IN}} - 0.2\text{V})$  (MAX6160)
- Optimized for 3V/5V Operation

## Applications

- 3V/5V Systems
- Battery-Powered Systems
- Portable and Hand-Held Equipment
- Data-Acquisition Systems
- Instrumentation and Process Control

## Ordering Information

PART	TEMP RANGE	PIN-PACKAGE	TOP MARK
MAX6125ESA	-40 $^{\circ}\text{C}$ to +85 $^{\circ}\text{C}$	8 SO	—
MAX6125EUR-T	-40 $^{\circ}\text{C}$ to +85 $^{\circ}\text{C}$	3 SOT23-3	EBAA
MAX6141ESA	-40 $^{\circ}\text{C}$ to +85 $^{\circ}\text{C}$	8 SO	—
MAX6141EUR-T	-40 $^{\circ}\text{C}$ to +85 $^{\circ}\text{C}$	3 SOT23-3	ECAA

Ordering Information appears at end of data sheet.

MAX6125/MAX6141/  
MAX6145/MAX6150/MAX6160

SOT23, Low-Cost, Low-Dropout,  
3-Terminal Voltage References

**Absolute Maximum Ratings**

(Voltages With Respect to GND)

IN .....-0.3V to +13.5V  
 OUT, ADJ.....-0.3V to (V<sub>IN</sub> + 0.3V)  
 Output Short-Circuit Duration (to IN or GND) ..... Continuous  
 Continuous Power Dissipation (T<sub>A</sub> = +70°C)  
 8-Pin SO (derate 5.9mW/°C above +70°C).....471mW

3-Pin SOT23 (derate 4mW/°C above +70°C) .....320mW  
 4-Pin SOT143 (derate 4mW/°C above +70°C) .....320mW  
 Operating Temperature Range .....-40°C to +85°C  
 Storage Temperature Range .....-65°C to +160°C  
 Lead Temperature (soldering, 10s) .....+300°C

*Stresses beyond those listed under "Absolute Maximum Ratings" may cause permanent damage to the device. These are stress ratings only, and functional operation of the device at these or any other conditions beyond those indicated in the operational sections of the specifications is not implied. Exposure to absolute maximum rating conditions for extended periods may affect device reliability.*

**Electrical Characteristics—MAX6125**

(V<sub>IN</sub> = 2.7V, I<sub>OUT</sub> = 0mA, T<sub>A</sub> = +25°C, unless otherwise noted.) (Note 1)

PARAMETER	SYMBOL	CONDITIONS	MIN	TYP	MAX	UNITS
Supply Voltage	V <sub>IN</sub>	T <sub>A</sub> = T <sub>MIN</sub> to T <sub>MAX</sub>	2.7		12.6	V
Output Voltage	V <sub>OUT</sub>	T <sub>A</sub> = +25°C	2.475	2.500	2.525	V
		T <sub>A</sub> = T <sub>MIN</sub> to T <sub>MAX</sub>	2.450		2.550	
Output Voltage Temperature Coefficient	TCV <sub>OUT</sub>	T <sub>A</sub> = T <sub>MIN</sub> to T <sub>MAX</sub>		15	50	ppm/°C
Output Voltage Noise	e <sub>n</sub>	0.1Hz to 10Hz		15		µV <sub>P-P</sub>
		10Hz to 10kHz		500		
Line Regulation	ΔV <sub>OUT</sub> /ΔV <sub>IN</sub>	V <sub>IN</sub> = 2.7V to 12.6V, T <sub>A</sub> = T <sub>MIN</sub> to T <sub>MAX</sub>		1	50	µV/V
Load Regulation	ΔV <sub>OUT</sub> /ΔI <sub>OUT</sub>	I <sub>SOURCE</sub> = 0mA to 1mA		0.4	1	mV/mA
		I <sub>SINK</sub> = 0mA to 1mA		1.15	10	
Quiescent Supply Current	I <sub>Q</sub>	T <sub>A</sub> = +25°C		75	100	µA
		T <sub>A</sub> = T <sub>MIN</sub> to T <sub>MAX</sub>			130	
Change in Supply Current vs. Change in Input Voltage	ΔI <sub>Q</sub> /ΔV <sub>IN</sub>	V <sub>IN</sub> = 2.7V to 12.6V		1.7	6	µA/V

**Electrical Characteristics—MAX6141**

(V<sub>IN</sub> = 4.3V, I<sub>OUT</sub> = 0mA, T<sub>A</sub> = +25°C, unless otherwise noted.) (Note 1)

PARAMETER	SYMBOL	CONDITIONS	MIN	TYP	MAX	UNITS
Supply Voltage	V <sub>IN</sub>	T <sub>A</sub> = T <sub>MIN</sub> to T <sub>MAX</sub>	4.3		12.6	V
Output Voltage	V <sub>OUT</sub>	T <sub>A</sub> = +25°C	4.055	4.096	4.140	V
		T <sub>A</sub> = T <sub>MIN</sub> to T <sub>MAX</sub>	4.015		4.180	
Output Voltage Temperature Coefficient	TCV <sub>OUT</sub>	T <sub>A</sub> = T <sub>MIN</sub> to T <sub>MAX</sub>		15	50	ppm/°C
Output Voltage Noise	e <sub>n</sub>	0.1Hz to 10Hz		25		µV <sub>P-P</sub>
		10Hz to 10kHz		700		
Line Regulation	ΔV <sub>OUT</sub> /ΔV <sub>IN</sub>	V <sub>IN</sub> = 4.3V to 12.6V, T <sub>A</sub> = T <sub>MIN</sub> to T <sub>MAX</sub>		2	50	µV/V
Load Regulation	ΔV <sub>OUT</sub> /ΔI <sub>OUT</sub>	I <sub>SOURCE</sub> = 0mA to 1mA		0.55	1.6	mV/mA
		I <sub>SINK</sub> = 0mA to 1mA		1.65	16	
Quiescent Supply Current	I <sub>Q</sub>	T <sub>A</sub> = +25°C		78	105	µA
		T <sub>A</sub> = T <sub>MIN</sub> to T <sub>MAX</sub>			130	
Change in Supply Current vs. Change in Input Voltage	ΔI <sub>Q</sub> /ΔV <sub>IN</sub>	V <sub>IN</sub> = 4.3V to 12.6V		1.7	6	µA/V
Thermal Hysteresis				80		ppm

MAX6125/MAX6141/  
MAX6145/MAX6150/MAX6160

SOT23, Low-Cost, Low-Dropout,  
3-Terminal Voltage References

**Electrical Characteristics—MAX6145**

( $V_{IN} = 4.7V$ ,  $I_{OUT} = 0mA$ ,  $T_A = +25^\circ C$ , unless otherwise noted.) (Note 1)

PARAMETER	SYMBOL	CONDITIONS	MIN	TYP	MAX	UNITS
Supply Voltage	$V_{IN}$	$T_A = T_{MIN}$ to $T_{MAX}$	4.7		12.6	V
Output Voltage	$V_{OUT}$	$T_A = +25^\circ C$	4.455	4.500	4.545	V
		$T_A = T_{MIN}$ to $T_{MAX}$	4.410		4.590	
Output Voltage Temperature Coefficient	$TCV_{OUT}$	$T_A = T_{MIN}$ to $T_{MAX}$		15	50	ppm/ $^\circ C$
Output Voltage Noise	$e_n$	0.1Hz to 10Hz		30		$\mu V_{P-P}$
		10Hz to 10kHz		800		
Line Regulation	$\Delta V_{OUT}/\Delta V_{IN}$	$V_{IN} = 4.7V$ to $12.6V$ , $T_A = T_{MIN}$ to $T_{MAX}$		2	50	$\mu V/V$
Load Regulation	$\Delta V_{OUT}/\Delta I_{OUT}$	$I_{SOURCE} = 0mA$ to $1mA$		0.6	1.8	mV/mA
		$I_{SINK} = 0mA$ to $1mA$		1.75	18	
Quiescent Supply Current	$I_Q$	$T_A = +25^\circ C$		79	105	$\mu A$
		$T_A = T_{MIN}$ to $T_{MAX}$			130	
Change in Supply Current vs. Change in Input Voltage	$\Delta I_Q/\Delta V_{IN}$	$V_{IN} = 4.7V$ to $12.6V$		1.7	6	$\mu A/V$

**Electrical Characteristics—MAX6150**

( $V_{IN} = 5.2V$ ,  $I_{OUT} = 0mA$ ,  $T_A = +25^\circ C$ , unless otherwise noted.) (Note 1)

PARAMETER	SYMBOL	CONDITIONS	MIN	TYP	MAX	UNITS
Supply Voltage	$V_{IN}$	$T_A = T_{MIN}$ to $T_{MAX}$	5.2		12.6	V
Output Voltage	$V_{OUT}$	$T_A = +25^\circ C$	4.950	5.000	5.050	V
		$T_A = T_{MIN}$ to $T_{MAX}$	4.900		5.100	
Output Voltage Temperature Coefficient	$TCV_{OUT}$	$T_A = T_{MIN}$ to $T_{MAX}$		15	50	ppm/ $^\circ C$
Output Voltage Noise	$e_n$	0.1Hz to 10Hz		35		$\mu V_{P-P}$
		10Hz to 10kHz		900		
Line Regulation	$\Delta V_{OUT}/\Delta V_{IN}$	$V_{IN} = 5.2V$ to $12.6V$ , $T_A = T_{MIN}$ to $T_{MAX}$		1	50	$\mu V/V$
Load Regulation	$\Delta V_{OUT}/\Delta I_{OUT}$	$I_{SOURCE} = 0mA$ to $1mA$		0.65	2	mV/mA
		$I_{SINK} = 0mA$ to $1mA$		1.9	20	
Quiescent Supply Current	$I_Q$	$T_A = +25^\circ C$		80	110	$\mu A$
		$T_A = T_{MIN}$ to $T_{MAX}$			145	
Change in Supply Current vs. Change in Input Voltage	$\Delta I_Q/\Delta V_{IN}$	$V_{IN} = 5.2V$ to $12.6V$		1.7	6	$\mu A/V$

### Electrical Characteristics—MAX6160

( $V_{IN} = 2.7V$ ;  $I_{OUT} = 0mA$ ;  $R1 = 215k\Omega \pm 0.1\%$ ,  $R2 = 208k\Omega \pm 0.1\%$  (circuit of Figure 1);  $T_A = +25^\circ C$ ; unless otherwise noted.) (Notes 1, 2)

PARAMETER	SYMBOL	CONDITIONS	MIN	TYP	MAX	UNITS
Supply Voltage	$V_{IN}$	$T_A = T_{MIN}$ to $T_{MAX}$	2.7		12.6	V
Output Voltage Range		$T_A = T_{MIN}$ to $T_{MAX}$	1.23		$V_{IN} - 0.2$	V
Output Voltage	$V_{OUT}$	$T_A = +25^\circ C$	2.475	2.500	2.525	V
		$T_A = T_{MIN}$ to $T_{MAX}$	2.450		2.550	
ADJ Feedback Voltage Threshold	$V_{ADJ}$			1.23		V
ADJ Input Current	$I_{ADJ}$	$V_{ADJ} = 1.23V$		70		nA
Output Voltage Temperature Coefficient	$TCV_{OUT}$	$T_A = T_{MIN}$ to $T_{MAX}$		15	100	ppm/ $^\circ C$
Output Voltage Noise	$e_n$	0.1Hz to 10Hz		15		$\mu V_{P-P}$
		10Hz to 10kHz		500		
Line Regulation	$\Delta V_{OUT}/\Delta V_{IN}$	$V_{IN} = 2.7V$ to $12.6V$ , $T_A = T_{MIN}$ to $T_{MAX}$		1	50	$\mu V/V$
Load Regulation	$\Delta V_{OUT}/\Delta I_{OUT}$	$I_{SOURCE} = 0mA$ to $1mA$		0.35	1	mV/mA
		$I_{SINK} = 0mA$ to $1mA$		1.15	10	
Quiescent Supply Current	$I_Q$	$T_A = +25^\circ C$		75	100	$\mu A$
		$T_A = T_{MIN}$ to $T_{MAX}$			130	
Change in Supply Current vs. Change in Input Voltage	$\Delta I_Q/\Delta V_{IN}$	$V_{IN} = 2.7V$ to $12.6V$		1.7	6	$\mu A/V$

**Note 1:** All devices are 100% production tested at  $T_A = +25^\circ C$ , and are guaranteed by design for  $T_A = T_{MIN}$  to  $T_{MAX}$  as specified.

**Note 2:** R1 and R2 program the output voltage in the 1.23V to ( $V_{IN} - 0.2V$ ) range (see the *Setting the MAX6160 Output Voltage* section).

### Typical Operating Characteristics

( $V_{IN} = V_{IN(MIN)}$ ;  $I_{OUT} = 0mA$ ,  $T_A = +25^\circ C$ , unless otherwise noted.)

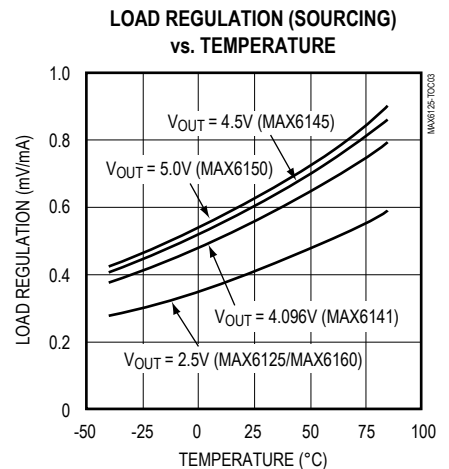
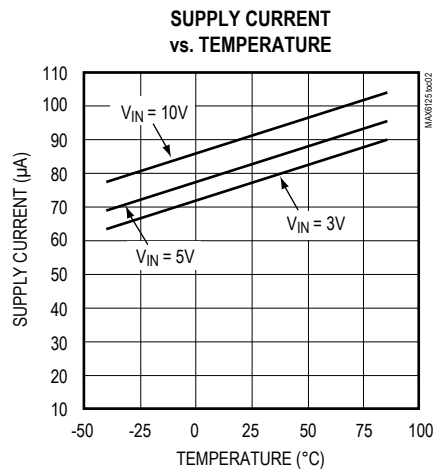
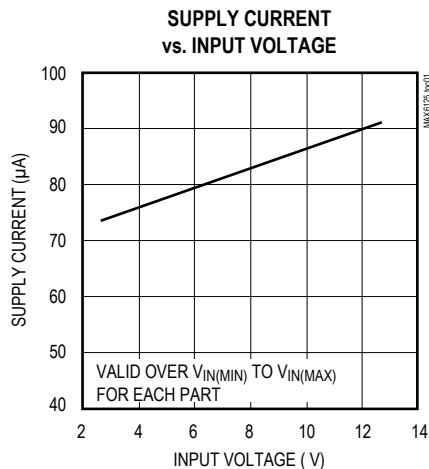

Typical Operating Characteristics (continued)

( $V_{IN} = V_{IN(MIN)}$ ,  $I_{OUT} = 0\text{mA}$ ,  $T_A = +25^\circ\text{C}$ , unless otherwise noted.)

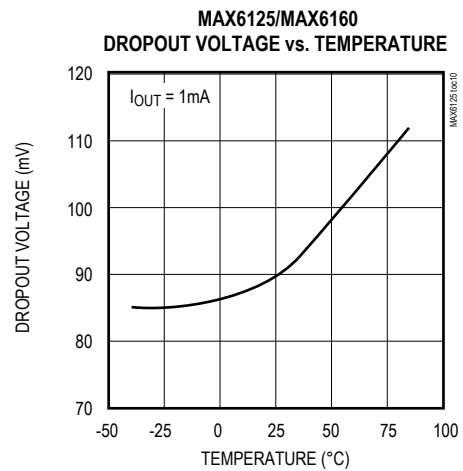
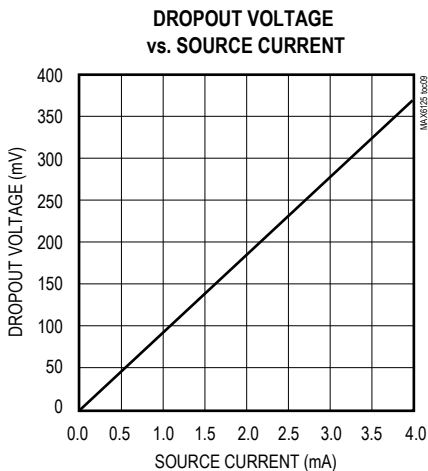
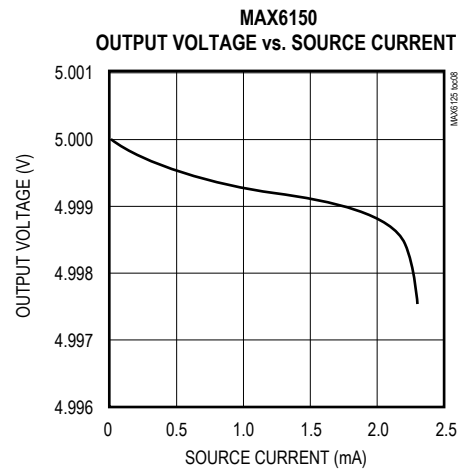
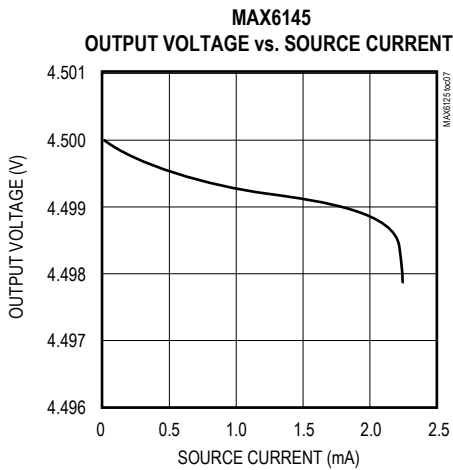
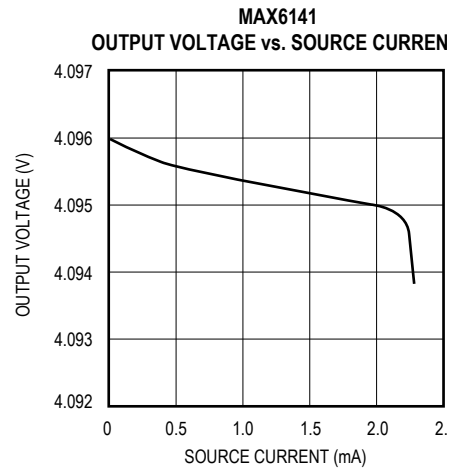
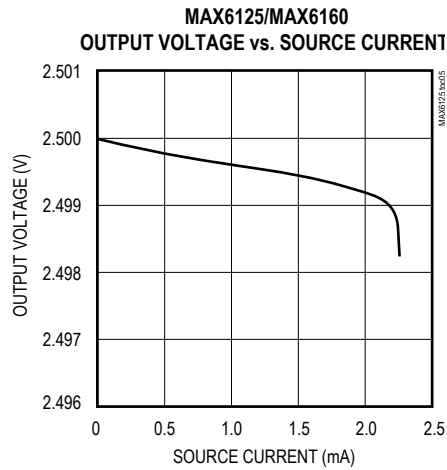
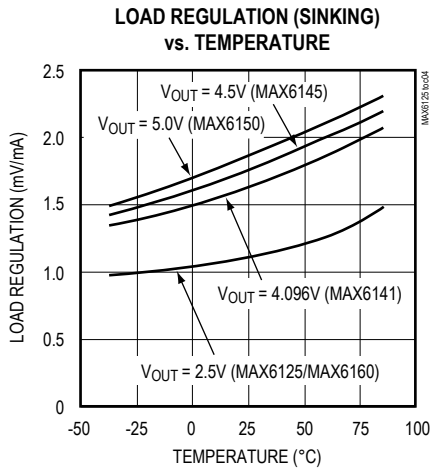

MAX6125/MAX6141/  
MAX6145/MAX6150/MAX6160

SOT23, Low-Cost, Low-Dropout,  
3-Terminal Voltage References

Typical Operating Characteristics (continued)

( $V_{IN} = V_{IN(MIN)}$ ,  $I_{OUT} = 0mA$ ,  $T_A = +25^{\circ}C$ , unless otherwise noted.)

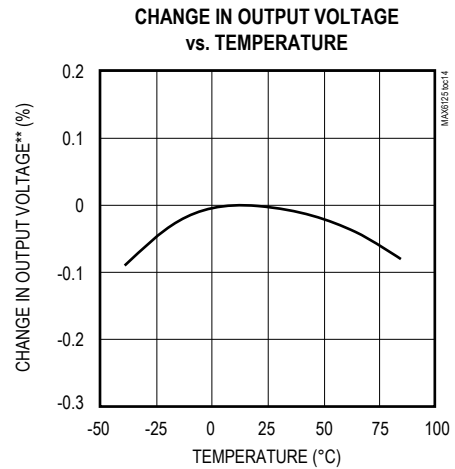
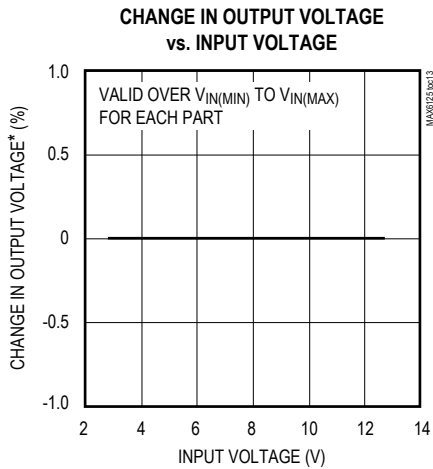
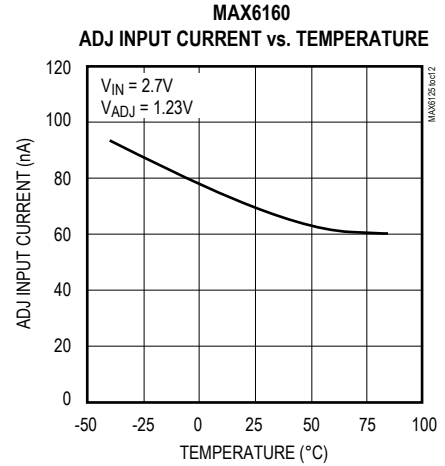
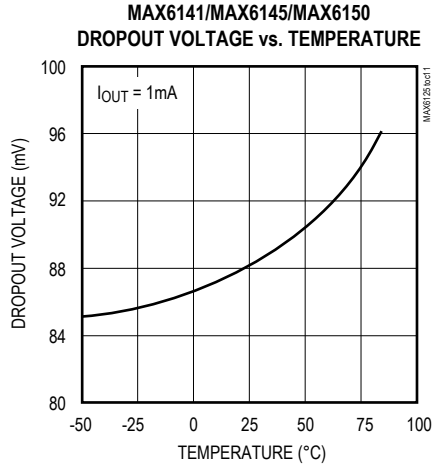

\*With respect to output voltage at  $V_{IN} = V_{IN(MIN)}$ .

\*\*With respect to output voltage at  $T_A = +25^{\circ}C$ .

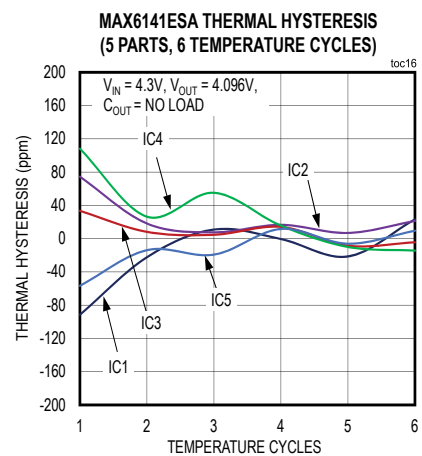
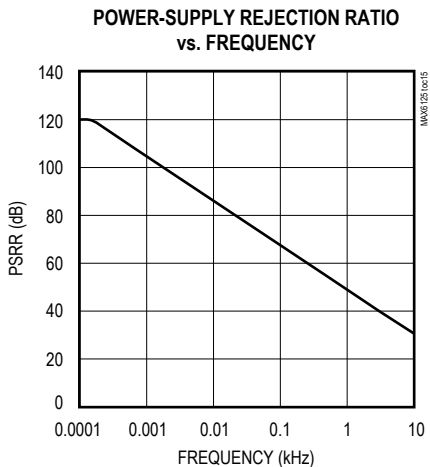

### Typical Operating Characteristics (continued)

( $V_{IN} = V_{IN(MIN)}$ ,  $I_{OUT} = 0mA$ ,  $T_A = +25^{\circ}C$ , unless otherwise noted.)

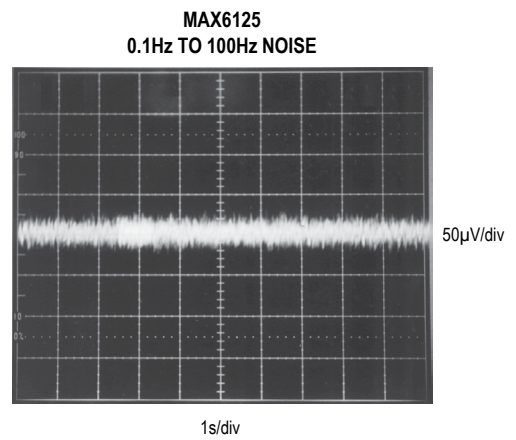
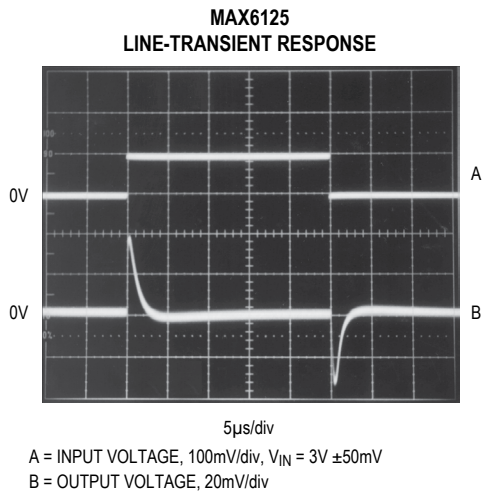
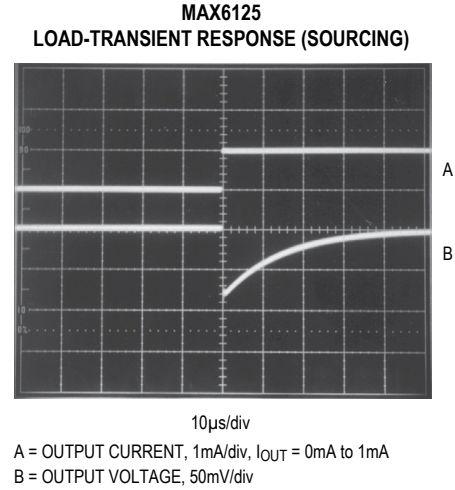
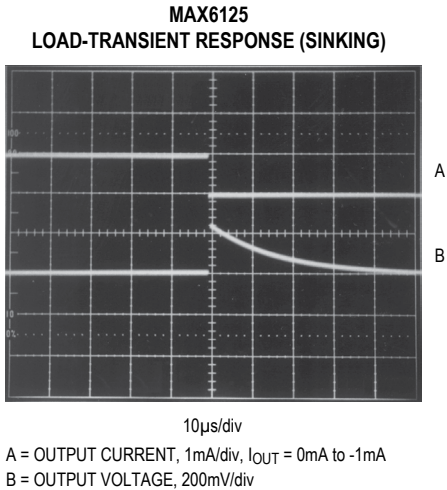

## Pin Description

PIN			NAME	FUNCTION
SO	SOT23-3	SOT143		
1	2	4	OUT	Reference Output
2, 3, 5*, 6, 7	—	—	N.C.	No Connection. Not internally connected.
4	3	1	GND	Ground
5**	—	2	ADJ	Adjustable output voltage feedback input. Connect a resistor divider between OUT, ADJ, and GND (Figure 1).
8	1	3	IN	Input Voltage

\*Except MAX6160.

\*\*MAX6160 only.

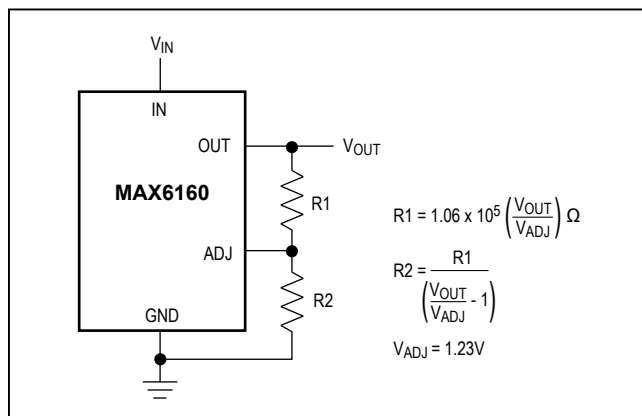

Figure 1. MAX6160 Adjustable Output Circuit

## Applications Information

### Setting the MAX6160 Output Voltage

Set the output voltage on the MAX6160 by connecting a resistor divider between OUT, ADJ, and GND (Figure 1). Choose R1 according to the following equation:

$$R1 = (1.06 \times 10^5) (V_{OUT} / V_{ADJ}) \Omega$$

where  $V_{TH} = 1.23V$ . The scaling factor ( $1.06 \times 10^5$ ) compensates for the MAX6160's change in ADJ input current over temperature. When R1 is chosen correctly, the change in voltage across R1 caused by the ADJ input current is properly cancelled. Choose R1 to within

$\pm 5\%$  of this calculated value (nearest standard value plus specified resistor tolerance) to optimize the output voltage temperature coefficient. Using  $R1 = 215k\Omega$ :

$$R2 = \frac{215k\Omega}{\left(\frac{2.5V}{1.23V} - 1\right)} \approx 208k\Omega$$

which is also the nearest 0.1% resistor value.

Choose R2 according to the following equation:

$$R2 = R1 / (V_{OUT} / V_{ADJ} - 1)$$

For example, a 2.5V output requires  $R1 = (1.06 \times 10^5) (2.5V / 1.23V) \approx 215k\Omega$ , which is the nearest standard-value 0.1% resistor.

### Input Bypassing

For the best line-transient performance, decouple the input with a  $0.1\mu F$  ceramic capacitor, as shown in the *Typical Operating Circuit*. Locate the capacitor as close to the device pin as possible. Where transient performance is less important, no capacitor is necessary.

### Output Bypassing

The MAX6125/MAX6141/MAX6145/MAX6150/MAX6160 do not require an output capacitor. They are stable for capacitive loads from 0nF to 10nF. If your application requires an output charge reservoir (e.g., to decouple the reference from a DAC's input), then make sure that the total output capacitive load does not exceed 10nF for optimum settling-time performance.

MAX6125/MAX6141/  
MAX6145/MAX6150/MAX6160

SOT23, Low-Cost, Low-Dropout,  
3-Terminal Voltage References

### Ordering Information (continued)

PART	TEMP RANGE	PIN-PACKAGE	TOP MARK
MAX6145ESA	-40°C to +85°C	8 SO	—
MAX6145EUR-T	-40°C to +85°C	3 SOT23-3	EDAA
MAX6150ESA	-40°C to +85°C	8 SO	—
MAX6150EUR-T	-40°C to +85°C	3 SOT23-3	EEAA
MAX6160ESA	-40°C to +85°C	8 SO	—
MAX6160EUS-T	-40°C to +85°C	4 SOT143-4	JXAA

### Chip Information

TRANSISTOR COUNT: 42

### Typical Operating Circuit

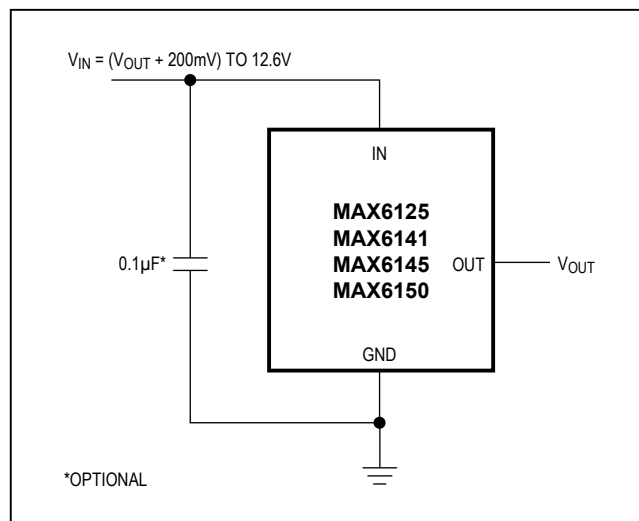

MAX6125/MAX6141/  
MAX6145/MAX6150/MAX6160

SOT23, Low-Cost, Low-Dropout,  
3-Terminal Voltage References

### Package Information

For the latest package outline information and land patterns (footprints), go to [www.maximintegrated.com/packages](http://www.maximintegrated.com/packages). Note that a "+", "#", or "-" in the package code indicates RoHS status only. Package drawings may show a different suffix character, but the drawing pertains to the package regardless of RoHS status.

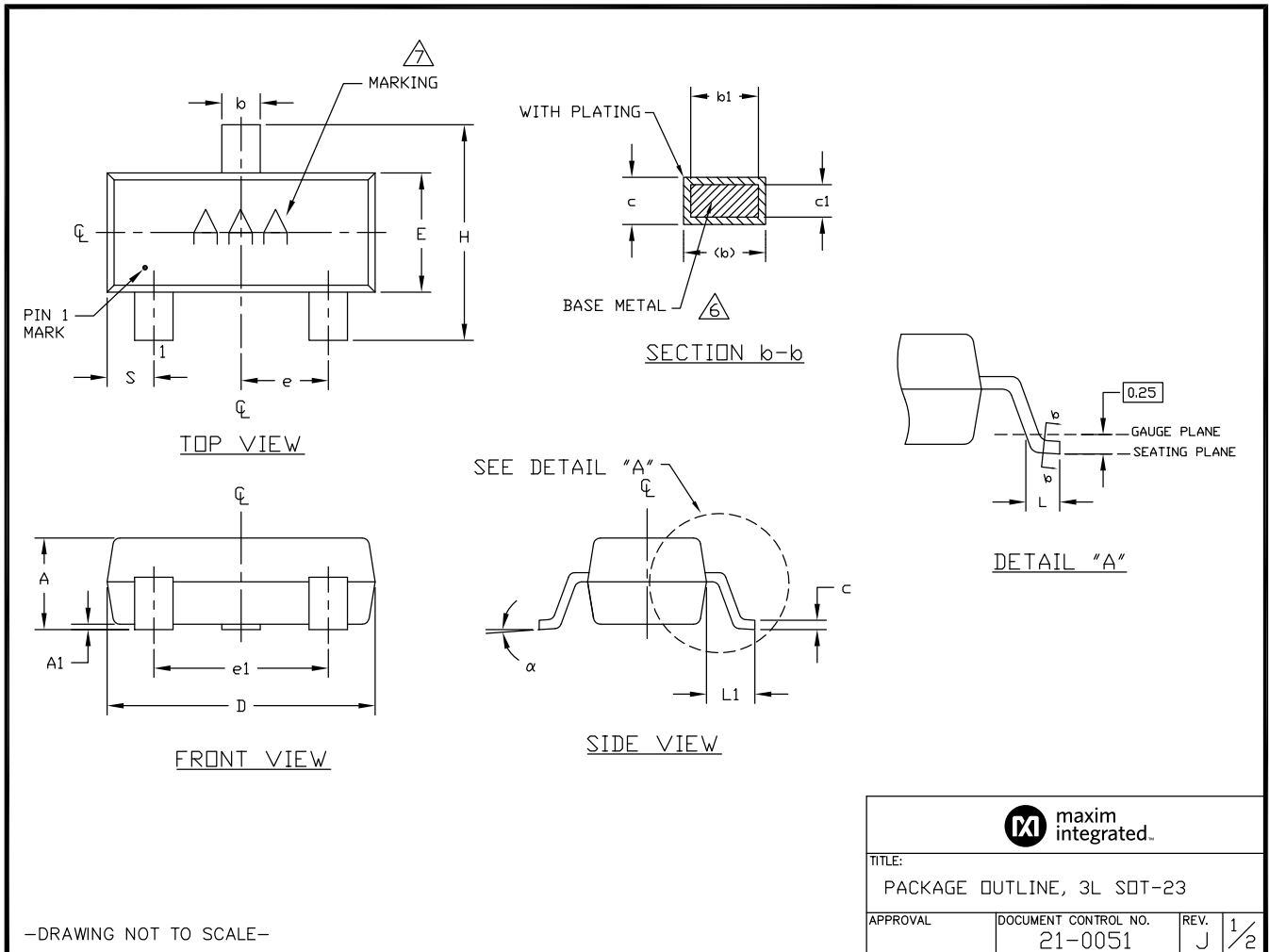

**Package Information (continued)**

For the latest package outline information and land patterns (footprints), go to [www.maximintegrated.com/packages](http://www.maximintegrated.com/packages). Note that a "+", "#", or "-" in the package code indicates RoHS status only. Package drawings may show a different suffix character, but the drawing pertains to the package regardless of RoHS status.

NOTES:

1. D&E DO NOT INCLUDE MOLD FLASH.
2. MOLD FLASH OR PROTRUSIONS NOT TO EXCEED .15mm (.006").
3. CONTROLLING DIMENSION: MILLIMETERS.
4. REFERENCE JEDEC TD236-VARIATION AB.
5. LEADS TO BE COPLANAR WITHIN 0.10mm.
- △ DIMENSIONS MEASURED AT FLAT SECTION OF LEAD BETWEEN 0.08mm AND 0.15mm FROM LEAD TIP.
- △ MARKING SHOWN IS FOR PACKAGE ORIENTATION REFERENCE ONLY.
8. MATERIAL MUST COMPLY WITH BANNED AND RESTRICTED SUBSTANCES SPEC # 10-0131.
9. ALL DIMENSIONS APPLY TO BOTH LEADED (-) AND Pk6FREE (+) PKG. CODES.

DIM	INCHES			MILLIMETERS		
	MIN	NOM	MAX	MIN	NOM	MAX
A	0.035	0.0394	0.044	0.890	1.000	1.120
A1	0.0004	0.0024	0.004	0.010	0.060	0.100
b	0.012	0.0165	0.020	0.300	0.420	0.500
b1	0.012		0.018	0.300		0.450
c	0.003	0.047	0.071	0.085	0.120	0.180
c1	0.003		0.071	0.080		0.160
D	0.110	0.115	0.120	2.800	2.920	3.040
E	0.047	0.0512	0.055	1.200	1.30	1.400
e	0.037 BSC.			0.950 BSC.		
e1	0.075 BSC.			1.900 BSC.		
H	0.083	0.0925	0.104	2.100	2.350	2.640
L	0.015	0.0205	0.023	0.400	0.520	0.600
L1	0.021 REF			0.54 REF		
S	0.018	0.0213	0.024	0.45	0.540	0.60
α	0°	2°	8°	0°	2	8°
PKG CODES: U3-1, U3-2, U3-5						

-DRAWING NOT TO SCALE-

 maxim integrated.			
TITLE: PACKAGE OUTLINE, 3L SOT-23			
APPROVAL	DOCUMENT CONTROL NO. 21-0051	REV. J	2/2

MAX6125/MAX6141/  
MAX6145/MAX6150/MAX6160

SOT23, Low-Cost, Low-Dropout,  
3-Terminal Voltage References

## Revision History

REVISION NUMBER	REVISION DATE	DESCRIPTION	PAGES CHANGED
2	8/16	Added new row to Electrical Characteristics table for Thermal Hysteresis spec and added TOC 16 to Typical Operating Characteristics	2, 6

For pricing, delivery, and ordering information, please contact Maxim Direct at 1-888-629-4642, or visit Maxim Integrated's website at [www.maximintegrated.com](http://www.maximintegrated.com).

*Maxim Integrated cannot assume responsibility for use of any circuitry other than circuitry entirely embodied in a Maxim Integrated product. No circuit patent licenses are implied. Maxim Integrated reserves the right to change the circuitry and specifications without notice at any time. The parametric values (min and max limits) shown in the Electrical Characteristics table are guaranteed. Other parametric values quoted in this data sheet are provided for guidance.*

## Looking for pricing, stock, or lifecycle information?

Click below to explore more details on WIN SOURCE:

 [View MAX6125EUR-T on WIN SOURCE](#)

 [Maxim Integrated](#) Information

## Optimize Your Supply Chain with WIN SOURCE Solutions

-  Global Sourcing Solution
-  Obsolete Management
-  Cost Control Management
-  Shortage Management
-  Alternative Solution
-  Excess Inventory Management