



**THE DATASHEET OF
DMP4025LK3Q-13**



Product Summary

BV _{DSS}	R _{DS(ON)} Max	I _D Max T _A = +25°C (Note 6)
-40V	25mΩ @ V _{GS} = -10V	-8.6A
	45mΩ @ V _{GS} = -4.5V	-7.0A

Description and Applications

This MOSFET is designed to meet the stringent requirements of automotive applications. It is qualified to AEC-Q101, supported by a PPAP and is ideal for use in:

- Motor controls
- Backlighting
- DC-DC converters
- Printer equipment

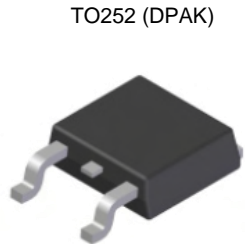

Top View

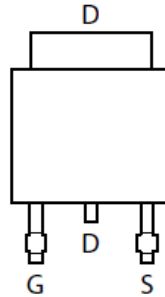

Top View
Pin Out

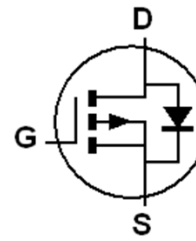

Device Symbol

Features

- Low On-Resistance
- Fast Switching Speed
- Low Input/Output Leakage
- **Lead-Free Finish; RoHS Compliant (Notes 1 & 2)**
- **Halogen and Antimony Free. "Green" Device (Note 3)**
- **The DMP4025LK3Q is suitable for automotive applications requiring specific change control; this part is AEC-Q101 qualified, PPAP capable, and manufactured in IATF 16949 certified facilities.**

<https://www.diodes.com/quality/product-definitions/>

Mechanical Data

- Package: TO252
- Package Material: Molded Plastic, "Green" Molding Compound. UL Flammability Classification Rating 94V-0
- Moisture Sensitivity: Level 1 per J-STD-020
- Terminals Connections: See Diagram Below
- Terminals: Finish - Matte Tin Annealed over Copper Lead Frame. Solderable per MIL-STD-202, Method 208 (3)
- Weight: 0.315 grams (Approximate)

Ordering Information (Note 4)

Part Number	Package	Packing	
		Qty.	Carrier
DMP4025LK3Q-13	TO252 (DPAK)	2,500	Tape & Reel

- Notes:
1. EU Directive 2002/95/EC (RoHS), 2011/65/EU (RoHS 2) & 2015/863/EU (RoHS 3) compliant. All applicable RoHS exemptions applied.
 2. See <https://www.diodes.com/quality/lead-free/> for more information about Diodes Incorporated's definitions of Halogen- and Antimony-free, "Green" and Lead-free.
 3. Halogen- and Antimony-free "Green" products are defined as those which contain <900ppm bromine, <900ppm chlorine (<1500ppm total Br + Cl) and <1000ppm antimony compounds.
 4. For packaging details, go to our website at <https://www.diodes.com/design/support/packaging/diodes-packaging/>.

Marking Information

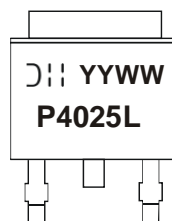

D = Manufacturer's Marking
 P4025L = Product Type Marking Code
 YYWW = Date Code Marking
 YY = Year (ex: 23 = 2023)
 WW = Week (01 to 53)

Maximum Ratings (@T_A = +25°C, unless otherwise specified.)

Characteristic			Symbol	Value	Unit	
Drain-Source Voltage			V _{DSS}	-40	V	
Gate-Source Voltage			V _{GSS}	±20		
Continuous Drain Current	V _{GS} = -10V	(Note 6)	I _D	-8.6	A	
		T _A = +70°C (Note 6)		-6.9		
		(Note 5)		-6.7		
Pulsed Drain Current	V _{GS} = -10V	(Note 7)	I _{DM}	-40		
Continuous Source Current (Body Diode)			(Note 7)	I _S		-8.6
Pulsed Source Current (Body Diode)			(Note 7)	I _{SM}		-40

Thermal Characteristics (@T_A = +25°C, unless otherwise specified.)

Characteristic			Symbol	Value	Unit
Power Dissipation	(Note 5)		P _D	1.7	W
	(Note 6)			2.78	
Thermal Resistance, Junction to Ambient	(Note 5)		R _{θJA}	74	°C/W
	(Note 6)			45	
Thermal Resistance, Junction to Case	(Note 6)		R _{θJC}	7.1	
Thermal Resistance, Junction to Lead	(Note 8)		R _{θJL}	1.43	
Operating and Storage Temperature Range			T _J , T _{STG}	-55 to +150	°C

- Notes:
5. For a device surface mounted on minimum recommended FR4 PCB with high coverage of single sided 1oz copper, in still air conditions; the device is measured when operating in a steady-state condition.
 6. Same as note (5), except the device is surface mounted on 25mm X 25mm X 1.6mm FR4 PCB.
 7. Repetitive rating on 25mm X 25mm FR4 PCB, D=0.02, pulse width 300µs – pulse width by maximum junction temperature.
 8. Thermal resistance from junction to solder-point (at the end of the drain lead).

Thermal Characteristics

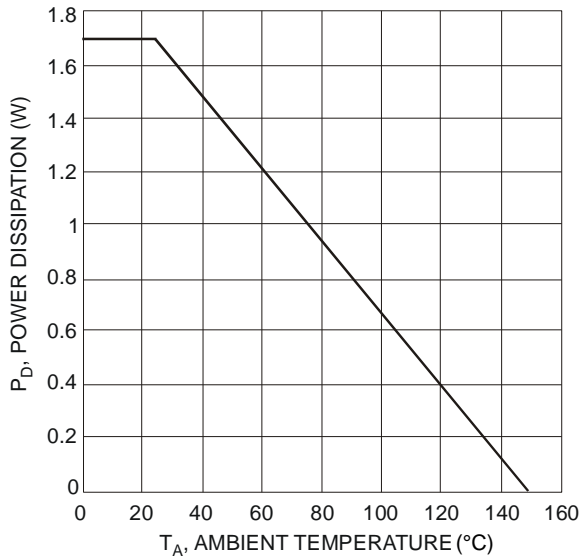

Figure 1. Power Dissipation vs. Ambient Temperature

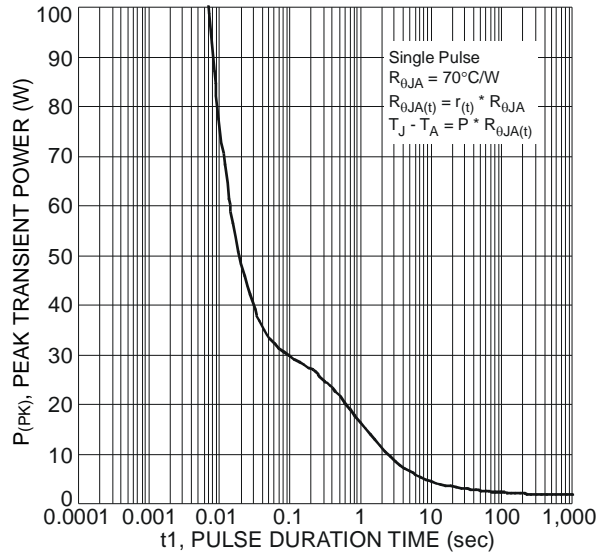

Figure 2. Single Pulse Maximum Power Dissipation

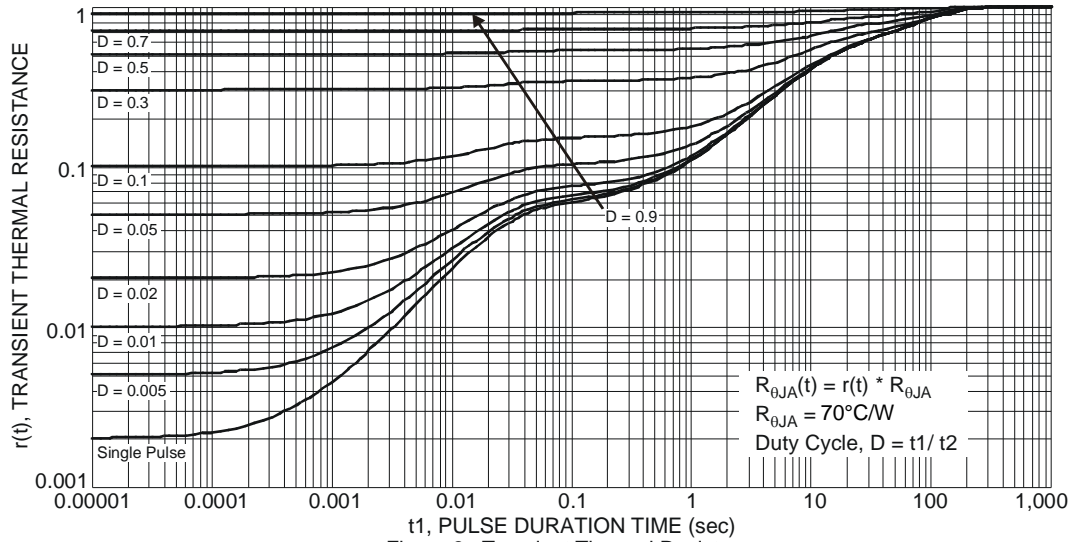

Figure 3. Transient Thermal Resistance

Electrical Characteristics (@T_A = +25°C, unless otherwise specified.)

Characteristic	Symbol	Min	Typ	Max	Unit	Test Condition
OFF CHARACTERISTICS						
Drain-Source Breakdown Voltage	BV _{DSS}	-40	—	—	V	I _D = -250μA, V _{GS} = 0V
Zero Gate Voltage Drain Current	I _{DSS}	—	—	-1	μA	V _{DS} = -40V, V _{GS} = 0V
Gate-Source Leakage	I _{GSS}	—	—	±100	nA	V _{GS} = ±20V, V _{DS} = 0V
ON CHARACTERISTICS						
Gate Threshold Voltage	V _{GS(TH)}	-0.8	-1.3	-1.8	V	I _D = -250μA, V _{DS} = V _{GS}
Static Drain-Source On-Resistance (Note 9)	R _{DS(ON)}	—	18	25	mΩ	V _{GS} = -10V, I _D = -3A
			30	45		V _{GS} = -4.5V, I _D = -3A
Forward Transconductance (Notes 9 & 10)	g _{fs}	—	16.6	—	S	V _{DS} = -5V, I _D = -3A
Diode Forward Voltage (Note 9)	V _{SD}	—	-0.7	-1	V	I _S = -1A, V _{GS} = 0V
DYNAMIC CHARACTERISTICS (Note 10)						
Input Capacitance	C _{iss}	—	1643	—	pF	V _{DS} = -20V, V _{GS} = 0V f = 1MHz
Output Capacitance	C _{oss}	—	179	—		
Reverse Transfer Capacitance	C _{rss}	—	128	—		
Gate Resistance	R _g	—	6.43	—	Ω	V _{DS} = 0V, V _{GS} = 0V, f = 1MHz
Total Gate Charge (Note 11)	Q _g	—	14	—	nC	V _{GS} = -4.5V V _{DS} = -20V I _D = -3A
Total Gate Charge (Note 11)	Q _g	—	33.7	—		
Gate-Source Charge (Note 11)	Q _{gs}	—	5.5	—		
Gate-Drain Charge (Note 11)	Q _{gd}	—	7.3	—		
Turn-On Delay Time (Note 11)	t _{D(ON)}	—	6.9	—	ns	V _{DD} = -20V, V _{GS} = -10V I _D = -3A
Turn-On Rise Time (Note 11)	t _R	—	14.7	—		
Turn-Off Delay Time (Note 11)	t _{D(OFF)}	—	53.7	—		
Turn-Off Fall Time (Note 11)	t _F	—	30.9	—		

Notes: 9. Measured under pulsed conditions. Pulse width ≤ 300μs; duty cycle ≤ 2%.
 10. For design aid only, not subject to production testing.
 11. Switching characteristics are independent of operating junction temperatures.

Typical Characteristics

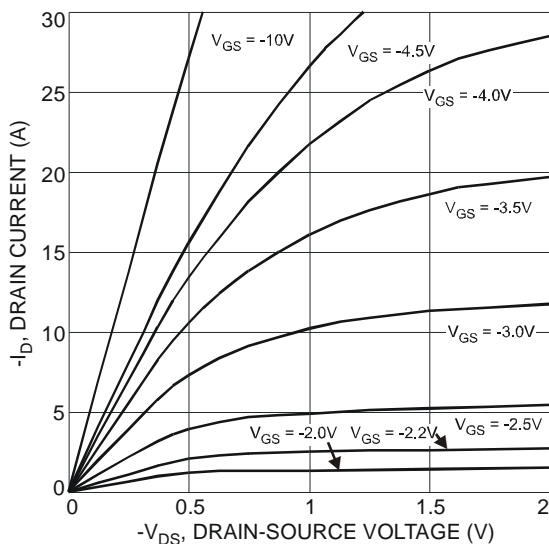

Figure 4. Typical Output Characteristic

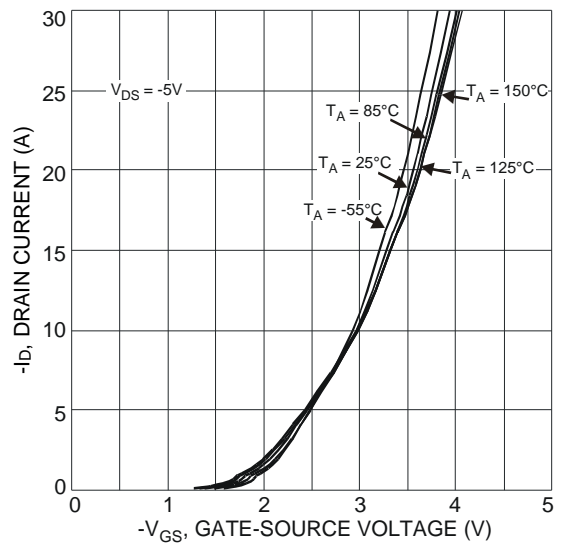

Figure 5. Typical Transfer Characteristic

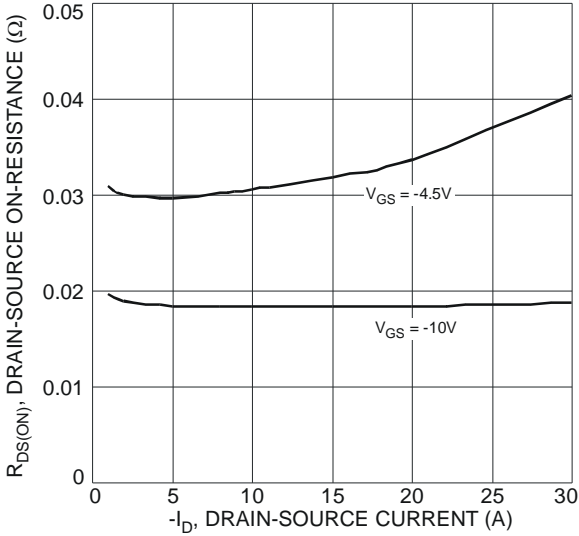

Figure 6. Typical On-Resistance vs. Drain Current and Gate Voltage

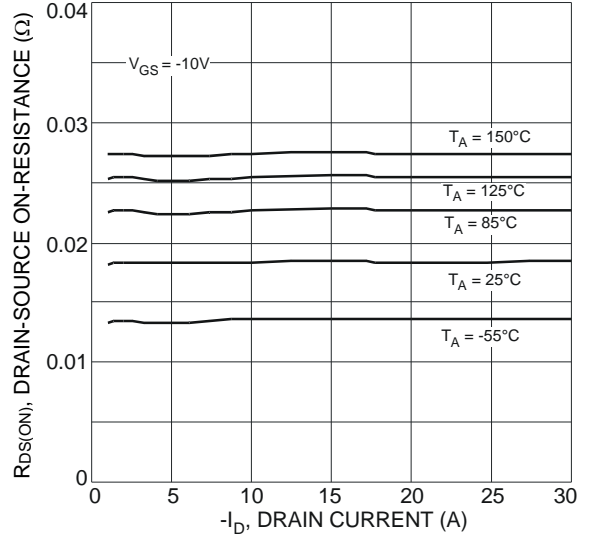

Figure 7. Typical On-Resistance vs. Drain Current and Temperature

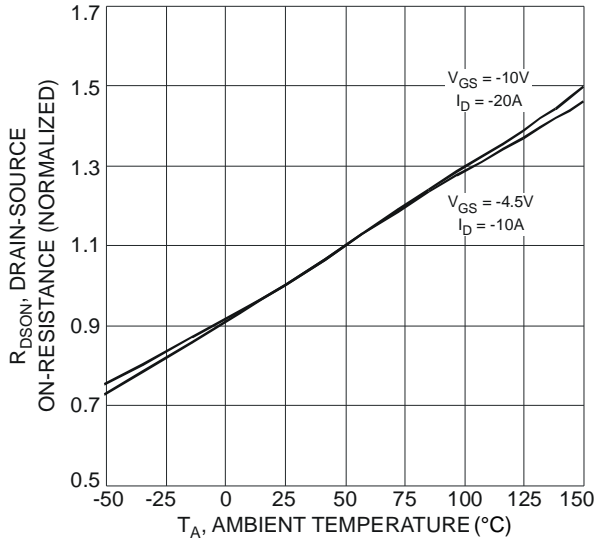

Figure 8. On-Resistance Variation with Temperature

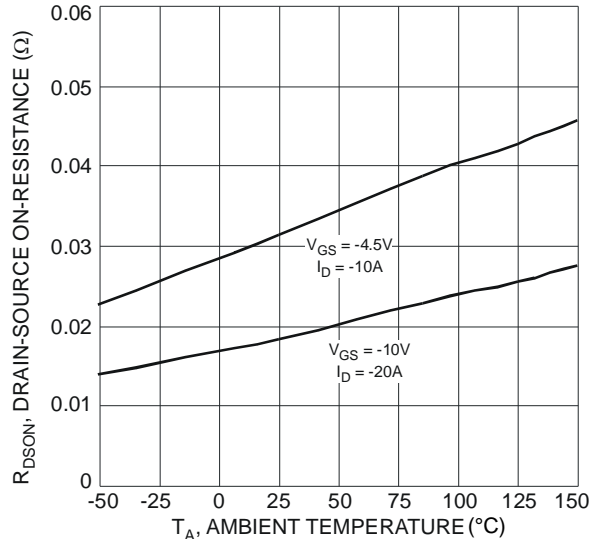

Figure 9. On-Resistance Variation with Temperature

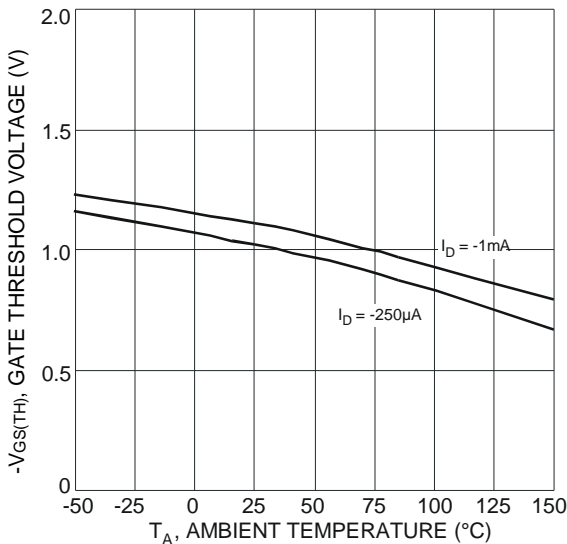

Figure 10. Gate Threshold Variation vs. Ambient Temperature

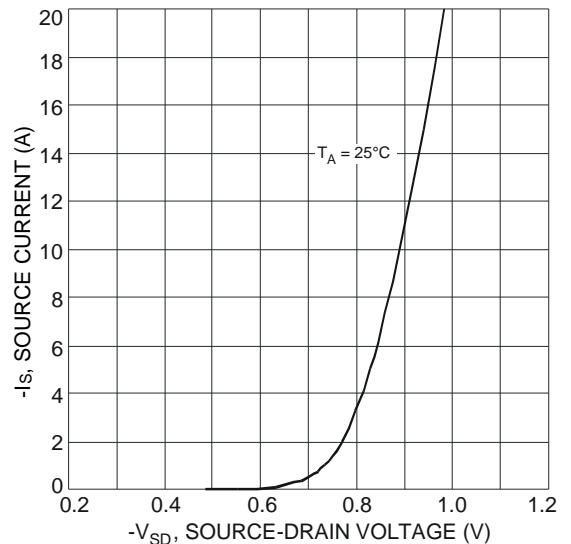

Figure 11. Diode Forward Voltage vs. Current

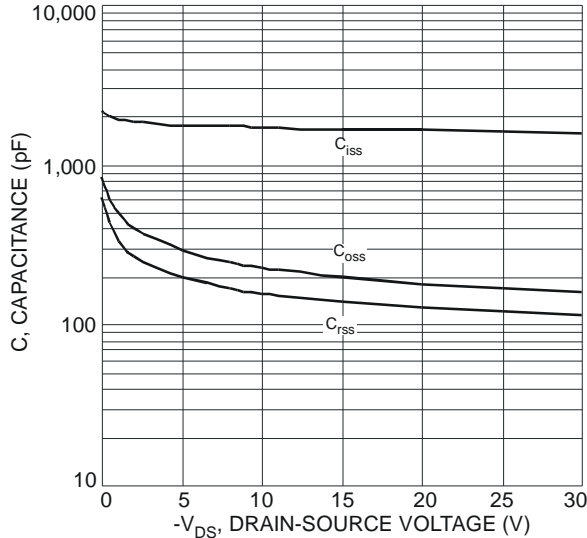

Figure 12. Typical Total Capacitance

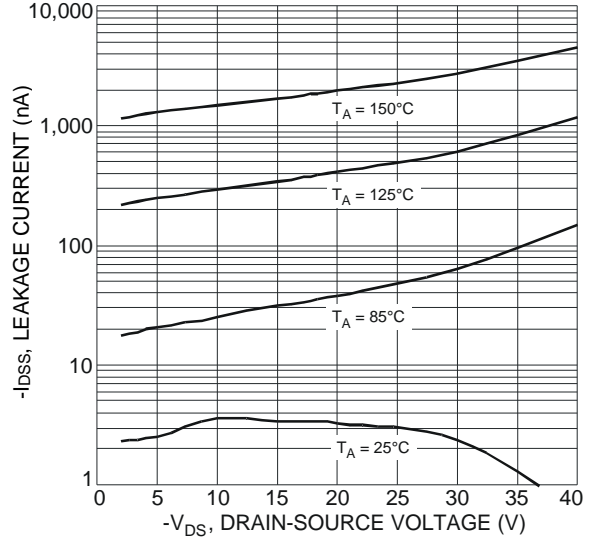

Figure 13. Typical Leakage Current vs. Drain-Source Voltage

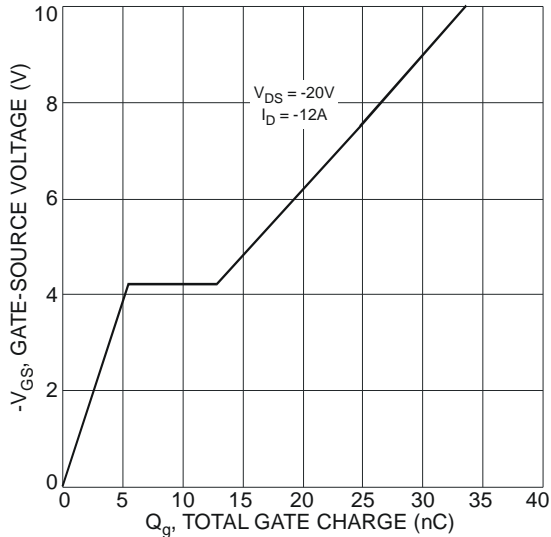

Figure 14. Gate-Charge Characteristics

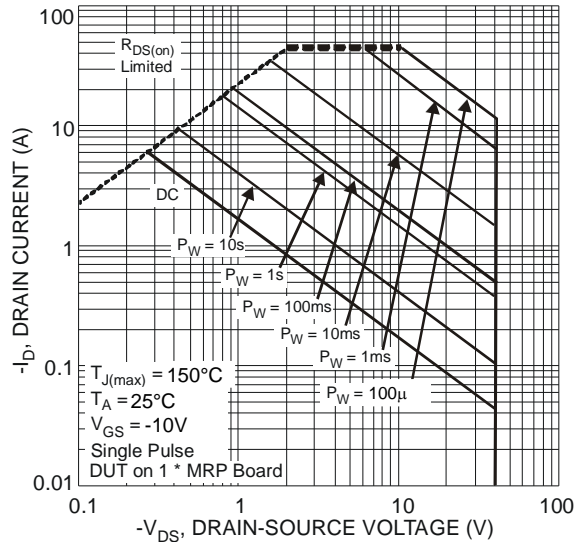
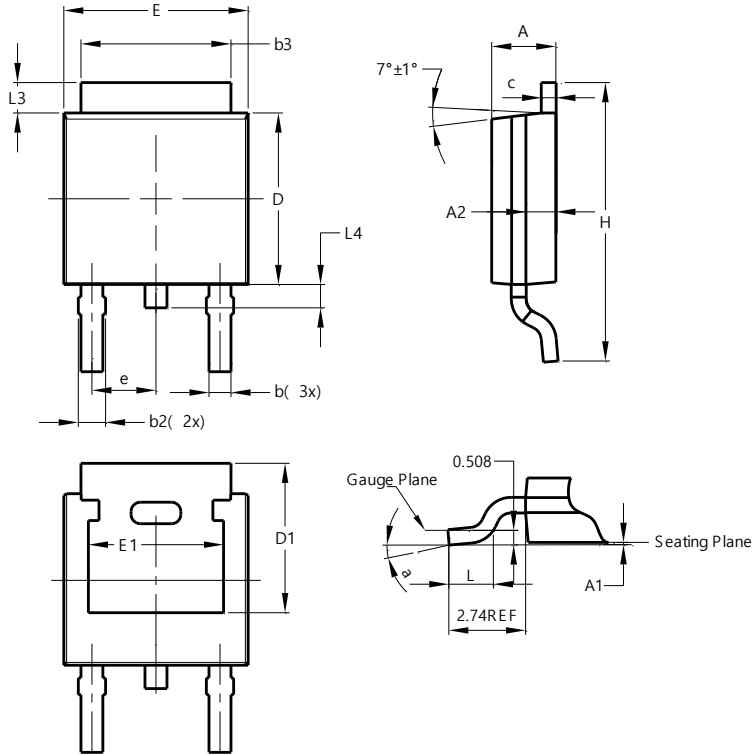

Figure 15. SOA, Safe Operation Area

Package Outline Dimensions

Please see <http://www.diodes.com/package-outlines.html> for the latest version.

TO252 (DPAK)



TO252 (DPAK)			
Dim	Min	Max	Typ
A	2.19	2.39	2.29
A1	0.00	0.13	0.08
A2	0.97	1.17	1.07
b	0.64	0.88	0.783
b2	0.76	1.14	0.95
b3	5.21	5.50	5.33
c	0.45	0.58	0.531
D	6.00	6.20	6.10
D1	5.21	--	--
e	2.286 BSC		
E	6.45	6.70	6.58
E1	4.32	--	--
H	9.40	10.41	9.91
L	1.40	1.78	1.59
L3	0.88	1.27	1.08
L4	0.64	1.02	0.83
a	0°	10°	--
All Dimensions in mm			

Suggested Pad Layout

Please see <http://www.diodes.com/package-outlines.html> for the latest version.

TO252 (DPAK)

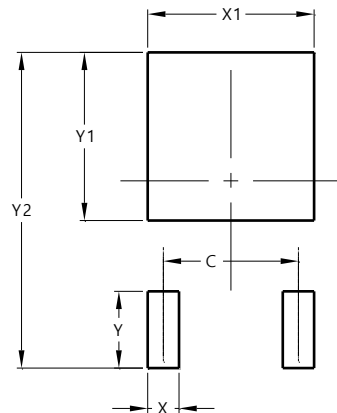

Dimensions	Value (in mm)
C	4.572
X	1.060
X1	5.632
Y	2.600
Y1	5.700
Y2	10.700

IMPORTANT NOTICE

1. DIODES INCORPORATED (Diodes) AND ITS SUBSIDIARIES MAKE NO WARRANTY OF ANY KIND, EXPRESS OR IMPLIED, WITH REGARDS TO ANY INFORMATION CONTAINED IN THIS DOCUMENT, INCLUDING, BUT NOT LIMITED TO, THE IMPLIED WARRANTIES OF MERCHANTABILITY, FITNESS FOR A PARTICULAR PURPOSE OR NON-INFRINGEMENT OF THIRD PARTY INTELLECTUAL PROPERTY RIGHTS (AND THEIR EQUIVALENTS UNDER THE LAWS OF ANY JURISDICTION).
2. The Information contained herein is for informational purpose only and is provided only to illustrate the operation of Diodes' products described herein and application examples. Diodes does not assume any liability arising out of the application or use of this document or any product described herein. This document is intended for skilled and technically trained engineering customers and users who design with Diodes' products. Diodes' products may be used to facilitate safety-related applications; however, in all instances customers and users are responsible for (a) selecting the appropriate Diodes products for their applications, (b) evaluating the suitability of Diodes' products for their intended applications, (c) ensuring their applications, which incorporate Diodes' products, comply the applicable legal and regulatory requirements as well as safety and functional-safety related standards, and (d) ensuring they design with appropriate safeguards (including testing, validation, quality control techniques, redundancy, malfunction prevention, and appropriate treatment for aging degradation) to minimize the risks associated with their applications.
3. Diodes assumes no liability for any application-related information, support, assistance or feedback that may be provided by Diodes from time to time. Any customer or user of this document or products described herein will assume all risks and liabilities associated with such use, and will hold Diodes and all companies whose products are represented herein or on Diodes' websites, harmless against all damages and liabilities.
4. Products described herein may be covered by one or more United States, international or foreign patents and pending patent applications. Product names and markings noted herein may also be covered by one or more United States, international or foreign trademarks and trademark applications. Diodes does not convey any license under any of its intellectual property rights or the rights of any third parties (including third parties whose products and services may be described in this document or on Diodes' website) under this document.
5. Diodes' products are provided subject to Diodes' Standard Terms and Conditions of Sale (<https://www.diodes.com/about/company/terms-and-conditions/terms-and-conditions-of-sales/>) or other applicable terms. This document does not alter or expand the applicable warranties provided by Diodes. Diodes does not warrant or accept any liability whatsoever in respect of any products purchased through unauthorized sales channel.
6. Diodes' products and technology may not be used for or incorporated into any products or systems whose manufacture, use or sale is prohibited under any applicable laws and regulations. Should customers or users use Diodes' products in contravention of any applicable laws or regulations, or for any unintended or unauthorized application, customers and users will (a) be solely responsible for any damages, losses or penalties arising in connection therewith or as a result thereof, and (b) indemnify and hold Diodes and its representatives and agents harmless against any and all claims, damages, expenses, and attorney fees arising out of, directly or indirectly, any claim relating to any noncompliance with the applicable laws and regulations, as well as any unintended or unauthorized application.
7. While efforts have been made to ensure the information contained in this document is accurate, complete and current, it may contain technical inaccuracies, omissions and typographical errors. Diodes does not warrant that information contained in this document is error-free and Diodes is under no obligation to update or otherwise correct this information. Notwithstanding the foregoing, Diodes reserves the right to make modifications, enhancements, improvements, corrections or other changes without further notice to this document and any product described herein. This document is written in English but may be translated into multiple languages for reference. Only the English version of this document is the final and determinative format released by Diodes.
8. Any unauthorized copying, modification, distribution, transmission, display or other use of this document (or any portion hereof) is prohibited. Diodes assumes no responsibility for any losses incurred by the customers or users or any third parties arising from any such unauthorized use.
9. This Notice may be periodically updated with the most recent version available at <https://www.diodes.com/about/company/terms-and-conditions/important-notice>

The Diodes logo is a registered trademark of Diodes Incorporated in the United States and other countries.
All other trademarks are the property of their respective owners.
© 2023 Diodes Incorporated. All Rights Reserved.

www.diodes.com

Looking for pricing, stock, or lifecycle information?

Click below to explore more details on WIN SOURCE:

 [View DMP4025LK3Q-13 on WIN SOURCE](#)

 [Diodes Incorporated](#) Information

Optimize Your Supply Chain with WIN SOURCE Solutions

-  Global Sourcing Solution
-  Obsolete Management
-  Cost Control Management
-  Shortage Management
-  Alternative Solution
-  Excess Inventory Management