



**THE DATASHEET OF  
T2SD-10-26-L-10.00-T-NDX**



**DESIGNED & DIMENSIONED  
IN MILLIMETERS[INCHES]**

DO NOT  
SCALE FROM  
THIS PRINT

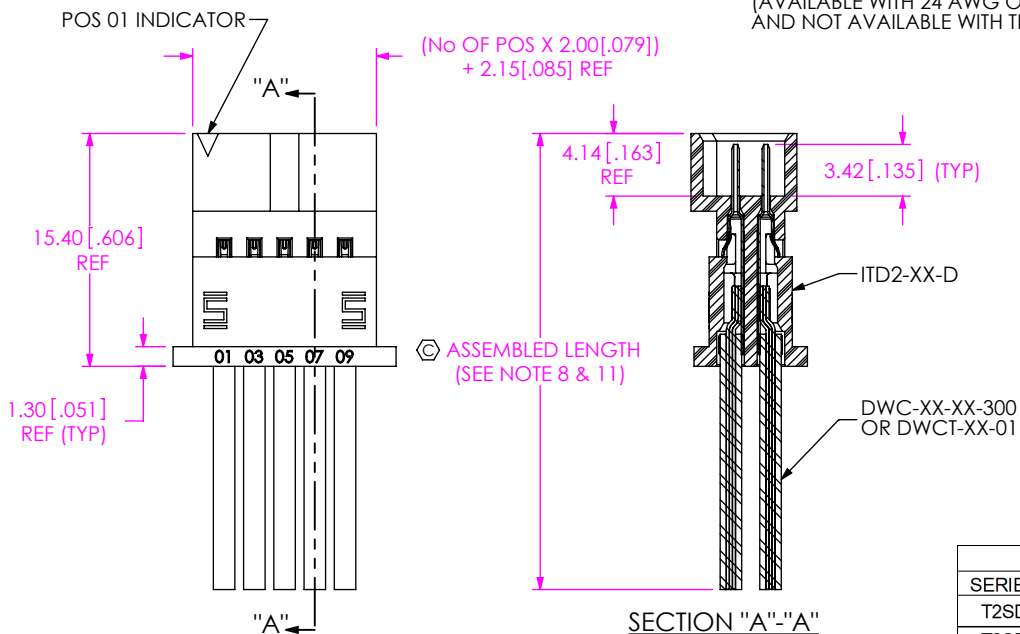
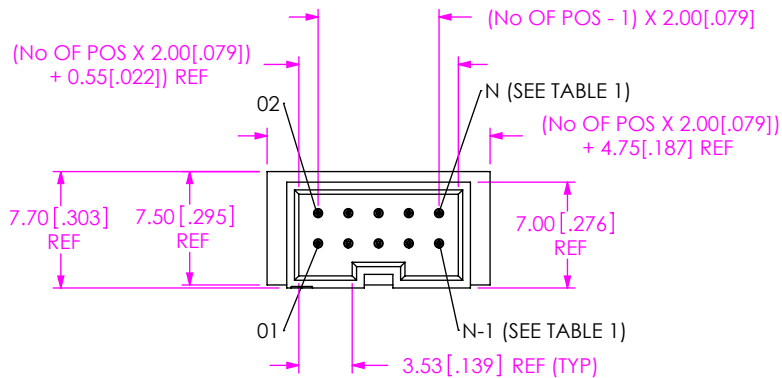

TABLE 1		
No OF POSITIONS	N	N-1
-02	4	3
-04	8	7
-05	10	9
-07	14	13
-10	20	19
-15	30	29
-20	40	39
-25	50	49
-30	60	59

FIG 1  
T2SDX-05-24-X-XX-XX-S SHOWN

NOTES:

1. Ⓢ REPRESENTS A CRITICAL DIMENSION.
2. MINIMUM PULLOUT FORCE: 2.5 LBS [11.1 N].
3. CONTACTS MUST BE INSERTED UNTIL RETENTION FEATURES LOCK INTO PLACE.
4. ALL FINISHED GOODS ARE TO BE ELECTRICALLY TESTED INCLUDING HI-POT TEST AT 1000 VOLTS DC. AFTER FINAL ELECTRICAL TEST, MARK EACH ASSEMBLY PER INSTRUCTIONS REFERENCED IN CO-(AD-ID)-WI-3092-M.
5. TINNED COPPER WIRE IS ROHS COMPLIANT.
6. PARTS TO BE LAYER PACKAGED.
7. END OF DISCRETE WIRE MUST FALL WITHIN THIS RANGE AFTER CRIMP.
8. FOR LENGTHS OF 12.00 INCHES AND LESS, TOLERANCE TO BE  $\pm 3.18[.125]$ , FOR LENGTHS GREATER THAN 12.00 INCHES, TOLERANCE TO BE  $\pm 2\%$
9. REFER TO CRIMP SPECIFICATIONS PRINT FOR CRIMP AND STRIP DIMENSIONS, TOLERANCES, AND TOOLING.
10. ASSEMBLYS USING THE FEP OPTION ARE FOR CRIMP APPLICATIONS ONLY.
11. CUT LENGTH IS ASSEMBLY LENGTH MINUS OVERALL LENGTH SUBTRACTOR.

F:\DWG\MISC\MKTG\T2SDX-XX-XXX-XX-XX-XX-XXX-MKT.SLDDRW

T2SDX-XX-XXX-XX-XX-XX-XXX

TEFLON CABLE OPTION  
-T: TEFLON (AVAILABLE WITH 24, 28, 30 AWG ONLY) (LEAVE BLANK FOR STANDARD PVC INSULATION) (SEE NOTE 10)

No OF POSITIONS  
-02, -03, -04, -05, -07, -10, -15, -20, -25, & -30 (PER ROW)  
AVAILABLE AS STANDARD  
-05 THRU -30 AVAILABLE AS ASO FOR POS NOT AVAILABLE AS STANDARD

WIRE GAUGE (AWG)  
-24, -26, -28, & -30

COLOR CODE:  
(LEAVE BLANK FOR ALL BLACK WIRE)  
\*\*C: COLOR CODED WIRE. SEE TABLE 3, SHEET 3 FOR COLOR SEQUENCE (AVAILABLE WITH 24 AWG ONLY AND NOT AVAILABLE WITH TEFLON)

-NXX OPTION (END 2)  
(ONLY AVAILABLE WITH -D, -T, & -TR)  
-NUS: NOTCH UP, STRAIGHT (PIN 1 TO N-1)  
-NDS: NOTCH DOWN, STRAIGHT (PIN 1 TO 2)  
-NUX: NOTCH UP, CROSSED (PIN 1 TO N)  
-NDX: NOTCH DOWN, CROSSED (PIN 1 TO 1)

END OPTION  
-S: SINGLE ENDED (SEE FIG 1)  
-D: DOUBLE ENDED (SEE FIG'S 2, 3, 4, & 5)  
-T: TRANSFER ENDED (SEE FIG'S 6, 7, 8, & 9)  
-TR: TRANSFER ENDED WITH RETENTION LATCH (SEE FIG'S 10, 11, 12, & 13)

ASSEMBLED LENGTH  
SPECIFY IN INCHES  
SINGLE ENDED: 03.00 INCH MINIMUM  
DOUBLE ENDED: 03.25 INCH MINIMUM

PLATING SPECIFICATION  
-L: 10μ" LIGHT SELECTIVE GOLD IN CONTACT AREA, BRIGHT ACID TIN ON TAIL  
-S: 30μ" SELECTIVE GOLD IN CONTACT AREA, BRIGHT ACID TIN ON TAIL  
-F: 3μ" FLASH GOLD IN CONTACT AREA, BRIGHT ACID TIN ON TAIL

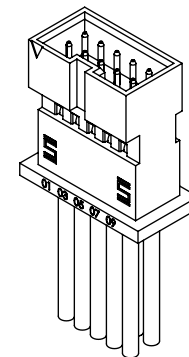

TABLE 2				
SERIES	WIRE GAUGE	CABLE	TERMINAL	CONTACT*
T2SD	24	DWC-24-XX-300	T-1M82-2426-XX	C-281-2426-X
T2SD	26	DWC-26-XX-300	T-1M82-2426-XX	C-281-2426-X
T2SD	28	DWC-28-XX-300	T-1M82-2830-XX	C-281-2830-X
T2SD	30	DWC-30-XX-300	T-1M82-2830-XX	C-281-2830-X
T2SDT	24	DWCT-24-01-TC	T-1M82-2426-XX	C-281-2426-X
T2SDT	28	DWCT-28-01-TC	T-1M82-2830-XX	C-281-2830-X
T2SDT	30	DWCT-30-01-TC	T-1M82-2830-XX	C-281-2830-X

UNLESS OTHERWISE SPECIFIED, DIMENSIONS ARE IN MILLIMETERS.  
TOLERANCES ARE:  
DECIMALS ANGLES  
X.X:  $\pm 0.3[.01]$  2°  
X.XX:  $\pm 0.13[.005]$   
X.XXX:  $\pm 0.051[.0020]$

PROPRIETARY NOTE  
THIS DOCUMENT CONTAINS CONFIDENTIAL AND PROPRIETARY INFORMATION AND ALL DESIGN, MANUFACTURING, REPRODUCTION, USE, PATENT RIGHTS AND SALES RIGHTS ARE EXPRESSLY RESERVED BY SAMTEC, INC. THIS DOCUMENT SHALL NOT BE DISCLOSED, IN WHOLE OR PART, TO ANY UNAUTHORIZED PERSON OR ENTITY NOR REPRODUCED, TRANSFERRED OR INCORPORATED IN ANY OTHER PROJECT IN ANY MANNER WITHOUT THE EXPRESS WRITTEN CONSENT OF SAMTEC, INC.

MATERIAL:  
INSULATOR: LCP, COLOR: BLACK  
TERMINAL: PHOS BRONZE  
CABLE INSULATION: SEE CALLOUT  
WIRE: TINNED COPPER

DO NOT SCALE DRAWING

SHEET SCALE: 2:1



520 PARK EAST BLVD, NEW ALBANY, IN 47150  
PHONE: 812-944-6733 FAX: 812-948-5047  
e-Mail info@SAMTEC.com code 55322

DESCRIPTION:  
2.00mm TERMINAL DISCRETE CABLE ASSM.

DWG. NO.  
T2SDX-XX-XXX-XX-XX-XX-XXX

BY: J. BORGELT 5/18/09 SHEET 1 OF 4

REVISION S

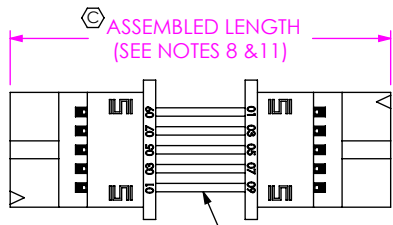
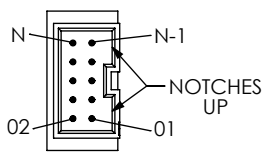

DWL-13-XXX-D-XX.XX-XX OR  
DWLT-13-XX-X-XX.XX-XX-XX FOR  
(-T) TEFLON OPTION (SEE TABLE 2)

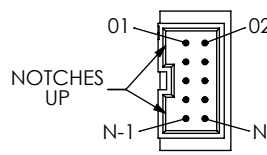
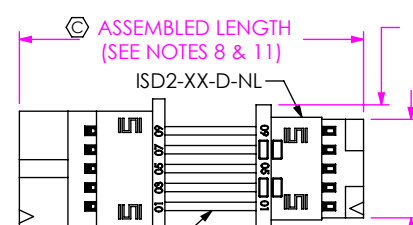
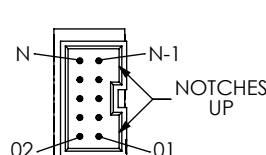

FIG 2  
T2SDX-05-28-X-XX.XX-D-NUS SHOWN  
(SAME AS FIG 1 EXCEPT AS SHOWN)  
(PIN 01 TO N-1)



DWL-13-XXX-D-XX.XX-XX OR  
DWLT-13-XX-X-XX.XX-XX-XX FOR  
(-T) TEFLON OPTION (SEE TABLE 2)

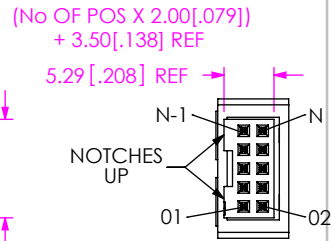

FIG 6  
T2SDX-05-28-X-XX.XX-T-NUS SHOWN  
(SAME AS FIG 1 EXCEPT AS SHOWN)  
(PIN 01 TO 01)

(No OF POS X 2.00[.079])  
+ 3.50[.138] REF  
5.29[.208] REF  
(No OF POS X 2.00[.079])  
+ .43[.017] REF  
11.38[.448] REF

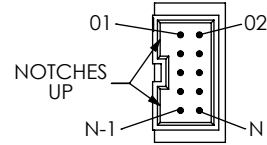
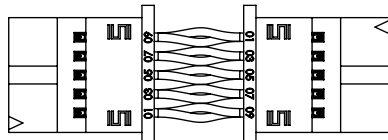
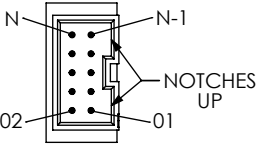

FIG 3  
T2SDX-05-28-X-XX.XX-D-NUX SHOWN  
(SAME AS FIG 1 EXCEPT AS SHOWN)  
(PIN 01 TO N)

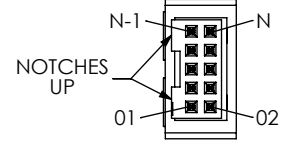
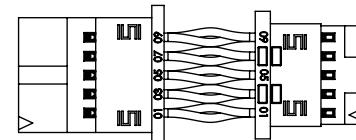
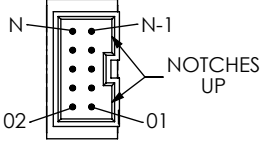

FIG 7  
T2SDX-05-28-X-XX.XX-T-NUX SHOWN  
(SAME AS FIG 6 EXCEPT AS SHOWN)  
(PIN 01 TO 02)

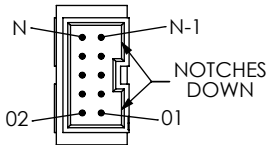
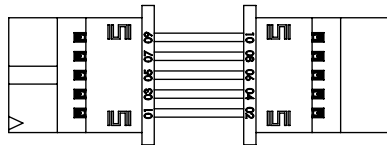
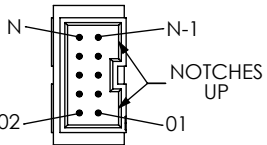

FIG 4  
T2SDX-05-28-X-XX.XX-D-NDS SHOWN  
(SAME AS FIG 1 EXCEPT AS SHOWN)  
(PIN 01 TO 02)

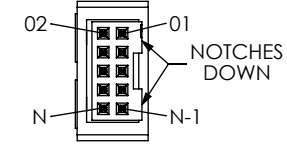
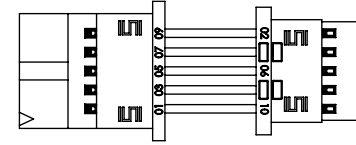
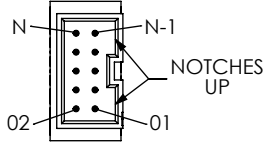

FIG 8  
T2SDX-05-28-X-XX.XX-T-NDS SHOWN  
(SAME AS FIG 6 EXCEPT AS SHOWN)  
(PIN 01 TO N)

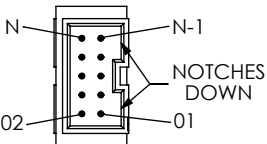
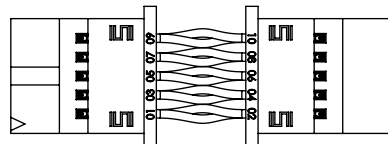
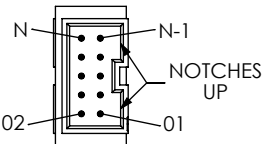

FIG 5  
T2SDX-05-28-X-XX.XX-D-NDX SHOWN  
(SAME AS FIG 1 EXCEPT AS SHOWN)  
(PIN 01 TO 01)

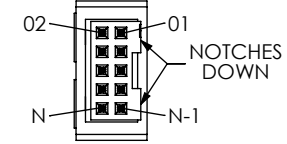
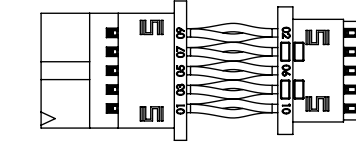
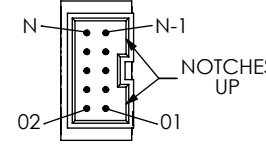

FIG 9  
T2SDX-05-28-X-XX.XX-T-NDX SHOWN  
(SAME AS FIG 6 EXCEPT AS SHOWN)  
(PIN 01 TO N-1)

PROPRIETARY NOTE  
THIS DOCUMENT CONTAINS CONFIDENTIAL AND PROPRIETARY INFORMATION AND ALL DESIGN, MANUFACTURING, REPRODUCTION, USE, PATENT RIGHTS AND SALES RIGHTS ARE EXPRESSLY RESERVED BY SAMTEC, INC. THIS DOCUMENT SHALL NOT BE DISCLOSED, IN WHOLE OR PART, TO ANY UNAUTHORIZED PERSON OR ENTITY NOR REPRODUCED, TRANSFERRED OR INCORPORATED IN ANY OTHER PROJECT IN ANY MANNER WITHOUT THE EXPRESS WRITTEN CONSENT OF SAMTEC, INC.

DO NOT SCALE DRAWING

SHEET SCALE: 1:25:1



520 PARK EAST BLVD. NEW ALBANY, IN 47150  
PHONE: 812-944-6733 FAX: 812-948-5047  
e-Mail info@SAMTEC.com code 55322

DESCRIPTION:  
2.00mm TERMINAL DISCRETE CABLE ASSM.

DWG. NO.  
T2SDX-XX-XXX-XX-XX.XX-XX-XXX

BY: J. BORGELT 5/18/09 SHEET 2 OF 4

REVISION S

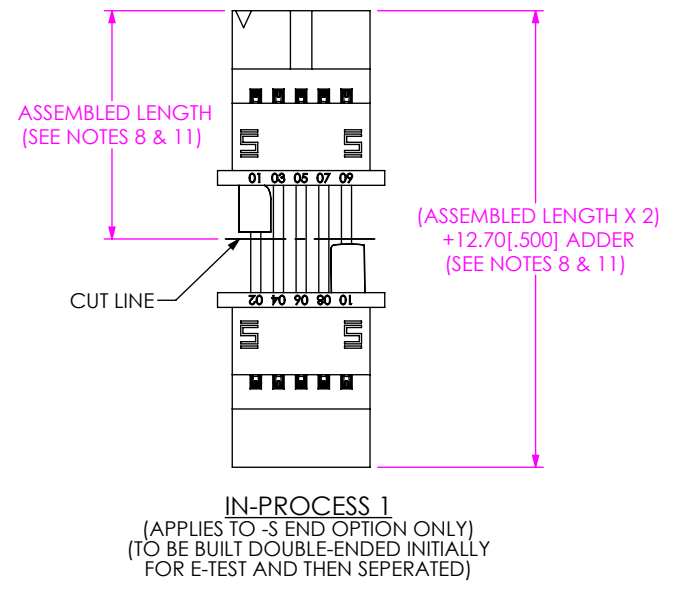
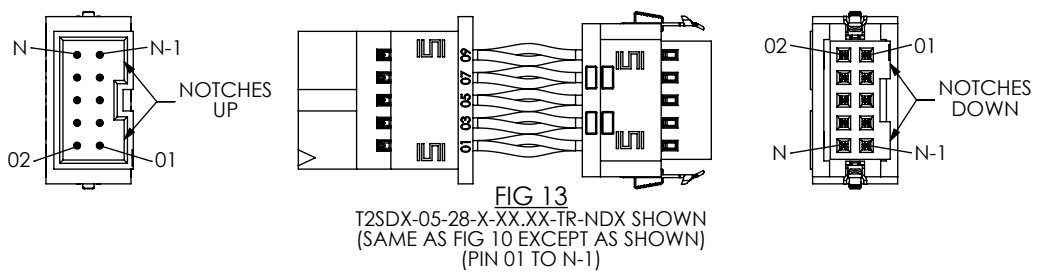
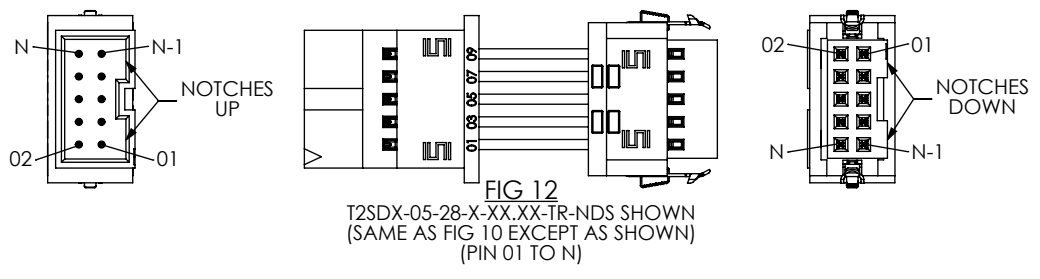
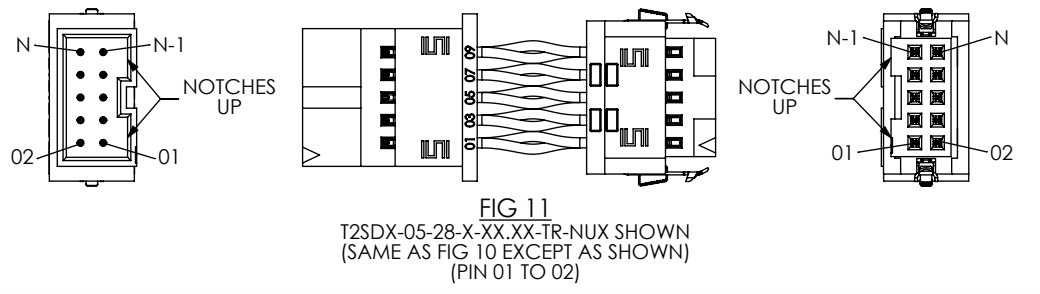
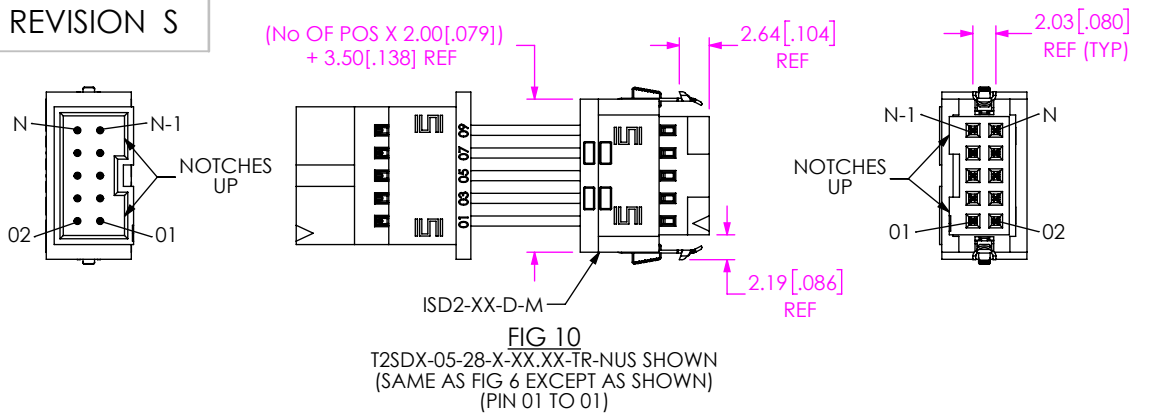

**TABLE 3**

COLOR SEQUENCE

POS #	BROWN	RED	ORANGE	YELLOW	GREEN	VIOLET	GRAY	WHITE	BLACK	BLUE
1	2	3	4	5	6	7	8	9	10	
11	12	13	14	15	16	17	18	19	20	
21	22	23	24	25	26	27	28	29	30	
31	32	33	34	35	36	37	38	39	40	
41	42	43	44	45	46	47	48	49	50	
51	52	53	54	55	56	57	58	59	60	
61	62	63	64	65	66	67	68	69	70	
71	72	73	74	75	76	77	78	79	80	
81	82	83	84	85	86	87	88	89	90	
91	92	93	94	95	96	97	98	99	100	

**PROPRIETARY NOTE**  
THIS DOCUMENT CONTAINS CONFIDENTIAL AND PROPRIETARY INFORMATION AND ALL DESIGN, MANUFACTURING, REPRODUCTION, USE, PATENT RIGHTS AND SALES RIGHTS ARE EXPRESSLY RESERVED BY SAMTEC, INC. THIS DOCUMENT SHALL NOT BE DISCLOSED, IN WHOLE OR PART, TO ANY UNAUTHORIZED PERSON OR ENTITY NOR REPRODUCED, TRANSFERRED OR INCORPORATED IN ANY OTHER PROJECT IN ANY MANNER WITHOUT THE EXPRESS WRITTEN CONSENT OF SAMTEC, INC.



520 PARK EAST BLVD, NEW ALBANY, IN 47150  
PHONE: 812-944-6733 FAX: 812-948-5047  
e-Mail info@SAMTEC.com code 55322

DO NOT SCALE DRAWING  
SHEET SCALE: 1.5:1

DESCRIPTION:  
2.00mm TERMINAL DISCRETE CABLE ASSM.  
DWG. NO.  
T2SDX-XX-XXX-XX-XX.XX-XX-XXX  
BY: J. BORGELT 5/18/09 SHEET 3 OF 4

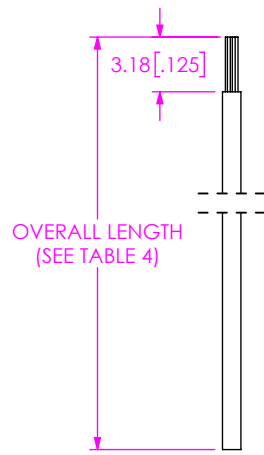

-S: SINGLE END

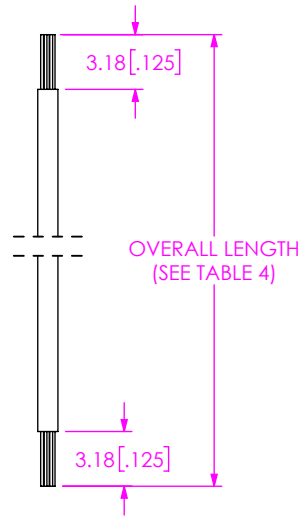

-D: DOUBLE END

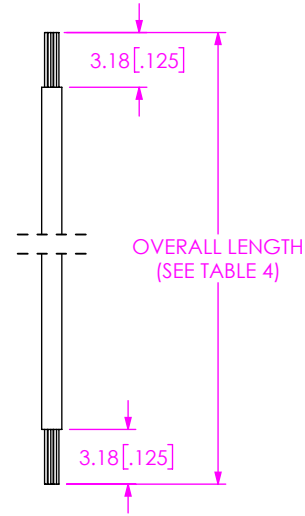

-T: TRANSFER END

CABLE CUT IN-PROCESS

TABLE 4 ( OVERALL LENGTH SUBTRACTORS) (SEE NOTE 11)	
	LENGTH
-S: SINGLE END	.375 [9.53]
-D: DOUBLE END	.750 [19.05]
-T: TRANSFER END	.600 [15.24]

**PROPRIETARY NOTE**

THIS DOCUMENT CONTAINS CONFIDENTIAL AND PROPRIETARY INFORMATION AND ALL DESIGN, MANUFACTURING, REPRODUCTION, USE, PATENT RIGHTS AND SALES RIGHTS ARE EXPRESSLY RESERVED BY SAMTEC, INC. THIS DOCUMENT SHALL NOT BE DISCLOSED, IN WHOLE OR PART, TO ANY UNAUTHORIZED PERSON OR ENTITY NOR REPRODUCED, TRANSFERRED OR INCORPORATED IN ANY OTHER PROJECT IN ANY MANNER WITHOUT THE EXPRESS WRITTEN CONSENT OF SAMTEC, INC.



520 PARK EAST BLVD, NEW ALBANY, IN 47150  
PHONE: 812-944-6733 FAX: 812-948-5047  
e-Mail info@SAMTEC.com code 55322

SHEET SCALE: 1.5:1



DESCRIPTION:  
2.00mm TERMINAL DISCRETE CABLE ASSM.

DWG. NO.  
T2SDX-XX-XXX-XX-XX.XX-XX-XXX

BY: J. BORGELT 5/18/09 SHEET 4 OF 4

## Looking for pricing, stock, or lifecycle information?

Click below to explore more details on WIN SOURCE:

-  [View T2SD-10-26-L-10.00-T-NDX on WIN SOURCE](#)
-  [Samtec Inc. Information](#)

## Optimize Your Supply Chain with WIN SOURCE Solutions

-  Global Sourcing Solution
-  Obsolete Management
-  Cost Control Management
-  Shortage Management
-  Alternative Solution
-  Excess Inventory Management