



**THE DATASHEET OF
BU9252F**



Audio digital delay (KARAOKE echo)

BU9252S / BU9252F

The BU9252S and BU9252F are digital delays specifically for Karaoke systems. Each has an internal sample hold circuit, an 8-bit A / D and D / A converter and 2kB SRAM, and allows for the selection of one of eight delay times just by attaching an inexpensive ceramic resonator.

A digital echo system can be formed by using either of these ICs together with the BA7725S or BA7725FS.

●Applications

Karaoke echo system

Electronic circuits that require signal delays

●Features

- | | |
|--|--|
| 1) Internal digital delay circuit. | 4) Internal 8-bit D / A converter. |
| 2) Internal 8-bit A / D converter. Sample rate. (14.22kHz when $f_{osc} = 455kHz$). | 5) CMOS design for low power consumption. |
| 3) Internal 2k bytes data SRAM. | 6) Internal sample hold circuit. |
| | 7) Internal feedback resistors and capacitors for oscillator circuits. |

●Block diagram

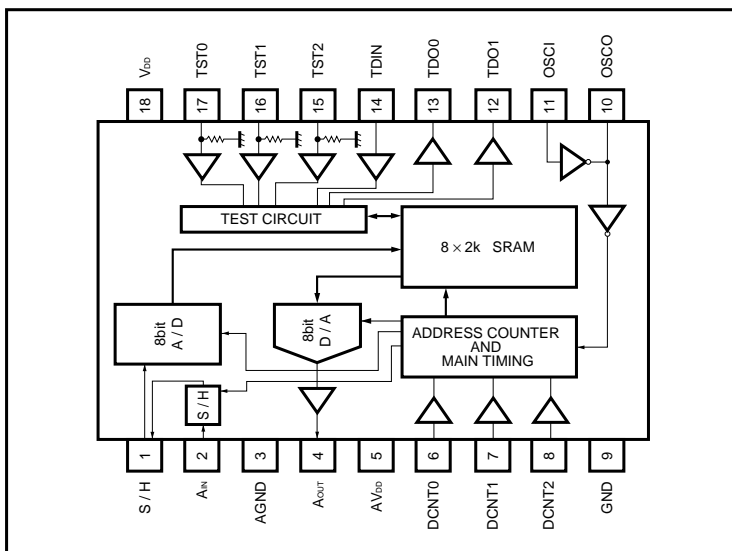

●Pin descriptions

Pin No.	Pin name	Function	Pin No.	Pin name	Function
1	S / H	For attaching sample-and-hold capacitor	10	OSCO	Oscillator pin 2
2	A _{IN}	Analog input	11	OSCI	Oscillator pin 1
3	AGND	Analog circuit ground	12	TDO1	Test pin (output)
4	A _{OUT}	Analog output	13	TDO0	Test pin (output)
5	AV _{DD}	Analog circuit power supply	14	TDIN	Test pin (input)
6	DCNT0	Delay setting input	15	TST2	Test mode setting
7	DCNT1	Delay setting input	16	TST1	Test mode setting
8	DCNT2	Delay setting input	17	TST0	Test mode setting
9	GND	Digital circuit ground	18	V _{DD}	Digital circuit power supply

●Input / output circuits

Pin name	Pin No.	Internal equivalent circuit	Pin name	Pin No.	Internal equivalent circuit
S / H	1		OSCI OSCO	11 10	
A _{IN}	2				
TDIN DCNT0 DCNT1 DCNT2	14 6 7 8				
TDO0 TDO1	13 12		A _{OUT}	4	
TST0 TST1 TST2	17 16 15				

● Absolute maximum ratings (Ta = 25°C)

Parameter	Symbol	Limits	Unit
Power supply voltage	V _{DD}	- 0.3 ~ + 7.0	V
Power dissipation	BU9252S	Pd	mW
	BU9252F		
			450* ²
Storage temperature	T _{stg}	- 55 ~ + 125	°C
Input voltage	V _{IN}	- 0.3 ~ V _{DD} + 0.3	V
Output voltage	V _{OUT}	- 0.3 ~ V _{DD} + 0.3	V

*1 IC only. Reduce by - 6mW / °C for each in Ta of 1°C over 25°C.

*2 IC only. Reduce by - 4.5mW / °C for each in Ta of 1°C over 25°C.

● Recommended operating conditions

Parameter	Symbol	Limits	Unit
Power supply voltage	V _{DD}	4.5 ~ 5.5	V
Analog power supply voltage	AV _{DD}	V _{DD}	V
Input "L" voltage	V _{IL}	0.0 ~ 0.2V _{DD}	V
Input "H" voltage	V _{IH}	0.8V _{DD} ~ V _{DD}	V
Analog input voltage	V _{AIN}	0 ~ AV _{DD}	V
Clock frequency	f _{OSC}	200 ~ 1000	kHz
Operating temperature	T _{opr}	- 10 ~ + 70	°C

● Electrical characteristics (unless otherwise noted, Ta = 25°C, V_{DD} = AV_{DD} = 5V)

Parameter	Symbol	Min.	Typ.	Max.	Unit	Conditions
Supply current	I _{DD}	—	3.5	12	mA	V _{AIN} = AV _{DD} , f _{OSC} = 455kHz
Analog output current	I _{AOUT}	1	4	—	mA	V _{AOUT} = 1V, V _{AIN} = 0V
		0.3	0.8	—	mA	V _{AOUT} = 0.5V _{DD} , V _{AIN} = V _{DD}
Analog input impedance	R _{AIN}	12	25	60	kΩ	*
A / D to D / A precision	RES	—	2	—	LSB	
OSCO output "L" voltage	V _{LOSC}	—	0.6	1.2	V	I _{OL} = 100μA
OSCO output "H" voltage	V _{HOSC}	3.8	4.4	—	V	I _{OH} = - 100μA
OSCI feedback loop current	I _{OSCI}	1	6	20	μA	V _{OSCI} = V _{DD}
Oscillation capacity	—	—	150	—	pF	

* The bias circuit is impedance.

●Circuit operation

(1) External capacitor for signal input pin

Audio signals compressed by the BA7725S or BA7725FS have their DC component removed by an AC coupling capacitor and are then input to pin 2 of BU9252S or BU9252F. At this stage, level deviations occur because the input signal is capacitor-divided by this AC coupling capacitor C28 and by sampling hold capacitor C27 connected to pin 1.

To prevent this, make sure that C27 is much lower than C28.

(Note: The numbers of external components are the numbers used in the system application example.)

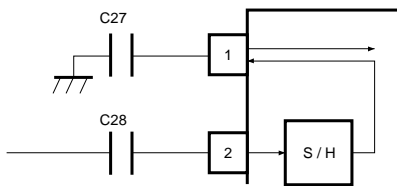

The sample-held analog signal is converted to digital by the serial 8-bit A / D converter and then temporarily stored in the internal SRAM (2k bytes).

(2) Relationship between oscillation frequency (CLK) and delay time

Sample rate $F = f_{osc} / 32$ (f_{osc} : oscillation frequency)

$$F = 14.22\text{kHz at } f_{osc} = 455\text{kHz}$$

Sample period $T = 1 / F$

Delay time $D_{time} = T \times \text{number of counts}$

The delay time can be set to any of the eight settings shown below by setting the logic inputs of terminals DCNT0 through DCNT2.

Logic input			Count	Delay time (ms) (when $f_{osc} = 455\text{kHz}$)
DCNT1	DCNT2	DCNT0	BU9252S / F	BU9252S / F
0	0	0	256	18.00
0	0	1	512	36.01
0	1	0	768	54.01
0	1	1	1024	72.02
1	0	0	1280	90.02
1	0	1	1536	108.03
1	1	0	1792	126.03
1	1	1	2048	144.04

(3) Delay timer settings

The delay time (i.e., the length of time the signal is stored in the SRAM) can be set to any of eight settings between the maximum and minimum delay times by setting pins 6, 7 and 8 to the combination of logic signal inputs that results in the corresponding number of counts. The maximum and minimum delay times are determined by the oscillation frequency of the attached ceramic resonator.

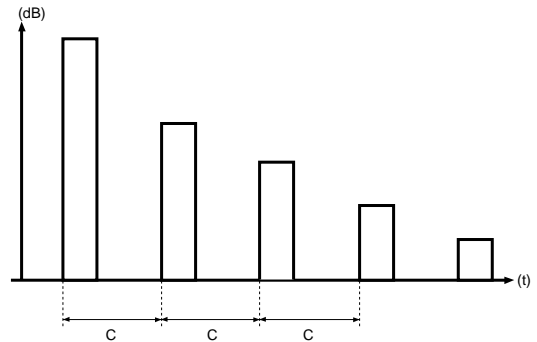

C : Delay time (ms)

Maximum and minimum delay times when using 300kHz, 375kHz and 455kHz ceramic oscillators

Delay time (ms)					
300kHz		375kHz		455kHz	
Max.	Min.	Max.	Min.	Max.	Min.
218.45	27.30	174.76	21.85	144.04	18.00

(4) Peripheral components of the ceramic oscillator
 An oscillator circuit can be configured simply by attaching a 455kHz ceramic resonator.

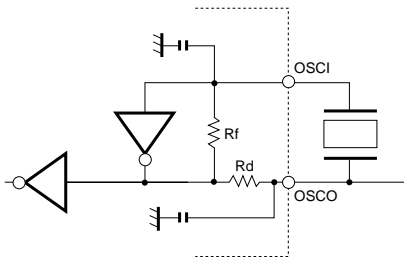

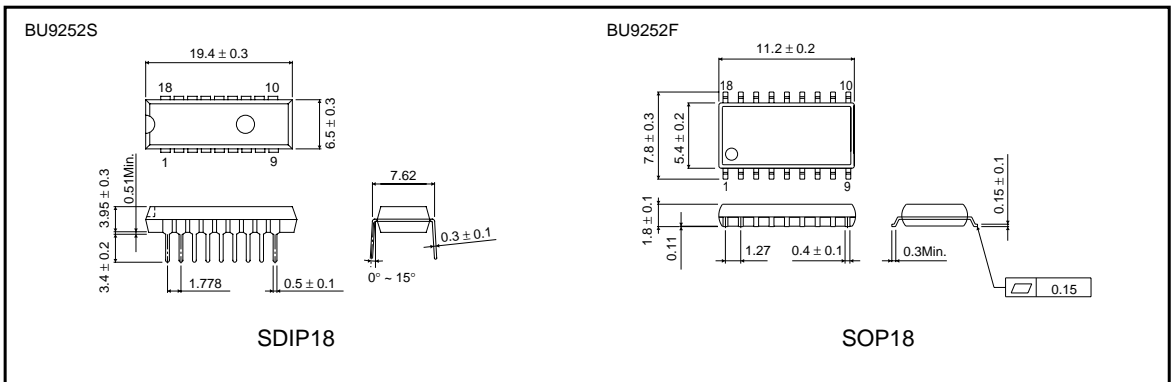

●External dimensions (Units: mm)



Looking for pricing, stock, or lifecycle information?

Click below to explore more details on WIN SOURCE:

-  [View BU9252F on WIN SOURCE](#)
-  [Rohm Semiconductor Information](#)

Optimize Your Supply Chain with WIN SOURCE Solutions

-  Global Sourcing Solution
-  Obsolete Management
-  Cost Control Management
-  Shortage Management
-  Alternative Solution
-  Excess Inventory Management