



## SZSMF Series



### Description

The SZSMF series is designed to protect sensitive systems or components from high voltage, high energy transients. It offers a fast response time, low Zener impedance, high surge and excellent clamping capabilities. Because of its small size, it is ideal for use in cellular phones, portable devices, business machines, power supplies and other industrial and consumer applications.

### Features

- Zener Transient Overvoltage Suppressors
- Stand-off Voltage: 5 – 58 Volts
- Peak Power: 200 Watts @ 1 ms
- Low Leakage
- Response Time is Typically < 1 ns
- ESD Rating of Class 3 (> 16 kV) per Human Body Model
- ESD Rating of Level 4 (8 kV Contact Discharge) per IEC 61000-4-2
- EFT (Electrical Fast Transients) Rating of 40 A per IEC 61000-4-4
- Low Profile: Maximum Height of 1.0 mm
- Small Footprint: Footprint Area of 8.45 mm<sup>2</sup>
- Supplied in 8 mm Tape and Reel – 3,000 Units per Reel
- Cathode Indicated by Polarity Band
- Lead Orientation in Tape: Cathode Lead to Sprocket Holes
- These components are Pb-Free and are RoHS Compliant
- SZ Prefix for Automotive and Other Applications Requiring Unique Site and Control Change Requirements; AEC-Q101 Qualified and PPAP Capable

### Agency Approvals

AGENCY	AGENCY FILE NUMBER
	E128662

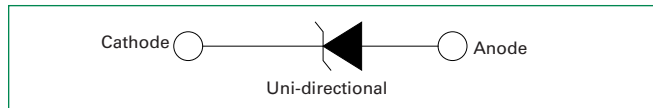
### Maximum Ratings and Thermal Characteristics

Rating	Symbol	Value	Unit
Maximum P <sub>pk</sub> Dissipation (PW=10/1000 μs) (Note 1)	P <sub>PK</sub>	200	W
Maximum P <sub>PK</sub> Dissipation @ T <sub>A</sub> = 25°C, (PW=8/20 μs) (Note 2)	P <sub>PK</sub>	1000	W
DC Power Dissipation @ T <sub>A</sub> = 25°C (Note 3)	P <sub>D</sub>	385	mW
Derate Above 25°C		4.0	mW/°C
Thermal Resistance from Junction-to-Ambient (Note 3)	R <sub>θJA</sub>	325	°C/W
Thermal Resistance, Junction-to-Lead (Note3)	R <sub>θJL</sub>	26	°C/W
Operating and Storage Temperature Range	T <sub>J</sub> , T <sub>stg</sub>	-55 to +150	°C

Stresses exceeding Maximum Ratings may damage the component. Maximum Ratings are stress ratings only. Functional operation above the Recommended Operating Conditions is not implied. Extended exposure to stresses above the Recommended Operating Conditions may affect component reliability.

1. Non-repetitive current pulse at T<sub>A</sub> = 25°C, per waveform of Figure 2.
2. Non-repetitive current pulse at T<sub>A</sub> = 25°C, per waveform of Figure 3.
3. Mounted with recommended minimum pad size, DC board FR-4.
4. 1/2 sine wave (or equivalent square wave), PW = 8.3 ms, duty cycle = 4 pulses per minute maximum.

### Functional Diagram



### Additional Information



Datasheet



Resources



Samples

### Electrical Characteristics ( $T_L = 30^\circ\text{C}$ unless otherwise noted, $V_F = 1.25$ Volts @ 200 mA)

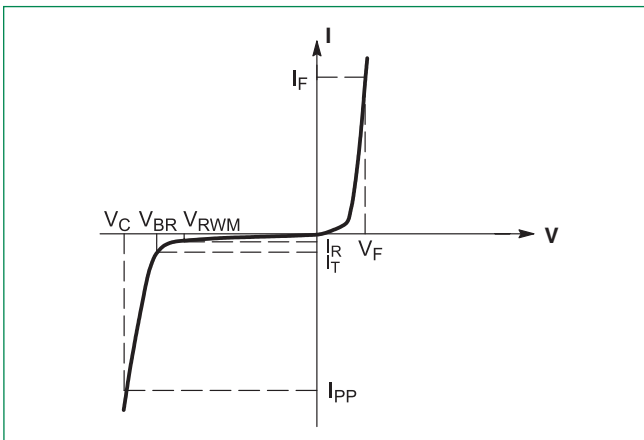
Device	Device Marking	$V_{RWM}$	$V_{BR} @ I_T$ (V) (Note 6)			@ $I_T$	$I_R @ V_{RWM}$	$V_C(\text{Max})$	$I_{PP}(\text{Max})$ (A)
			V	Min	Nom				
SZSMF5.0AT1G	KE	5	6.40	6.70	7.00	10	400	9.2	21.7
SZSMF6.0AT1G	KG	6	6.67	7.02	7.37	10	400	10.3	19.4
SZSMF6.5AT1G	KK	6.5	7.22	7.60	7.98	10	250	11.2	17.9
SZSMF7.0AT1G	KM	7	7.78	8.19	8.60	10	100	12	16.7
SZSMF7.5AT1G	KP	7.5	8.33	8.77	9.21	1	50	12.9	15.5
SZSMF8.0AT1G	KR	8	8.89	9.36	9.83	1	25	13.6	14.7
SZSMF9.0AT1G	KV	9	10.00	10.55	11.10	1	5	15.4	13.0
SZSMF10AT1G	KX	10	11.10	11.70	12.30	1	2.5	17	11.8
SZSMF11AT1G	KZ	11	12.20	12.85	13.50	1	2.5	18.2	11.0
SZSMF12AT1G	LE	12	13.30	14.00	14.70	1	2.5	19.9	10.1
SZSMF13AT1G	LG	13	14.40	15.15	15.90	1	1	21.5	9.3
SZSMF14AT1G	LK	14	15.60	16.40	17.20	1	1	23.2	8.6
SZSMF15AT1G	LM	15	16.70	17.60	18.50	1	1	24.4	8.2
SZSMF18AT1G	LT	18	20.00	21.00	22.10	1	1	29.2	6.8
SZSMF20AT1G	LV	20	22.20	23.35	24.50	1	1	32.4	6.2
SZSMF22AT1G	LX	22	24.40	25.60	26.90	1	1	35.5	5.6
SZSMF24AT1G	LZ	24	26.70	28.10	29.50	1	1	38.9	5.1
SZSMF26AT1G	ME	26	28.90	30.40	31.90	1	1	42.1	4.8
SZSMF28AT1G	MG	28	31.10	32.80	34.40	1	1	45.4	4.4
SZSMF30AT1G	MK	30	33.30	35.10	36.80	1	1	48.4	4.1
SZSMF33AT1G	MM	33	36.70	38.70	40.60	1	1	53.3	3.8
SZSMF36AT1G	MP	36	40.00	42.10	44.20	1	1	58.1	3.4
SZSMF48AT1G	MX	48	53.30	56.10	58.90	1	1	77.4	2.6
SZSMF58AT1G	NG	58	64.40	67.80	71.20	1	1	93.6	2.1

5. A transient suppressor is normally selected according to the Working Peak Reverse Voltage ( $V_{RWM}$ ) which should be equal to or greater than the DC or continuous peak operating voltage level.

6.  $V_{BR}$  measured at pulse test current  $I_T$  at ambient temperature of  $25^\circ\text{C}$ .

7. Surge current waveform per Figure 2 and derate per Figure 3.

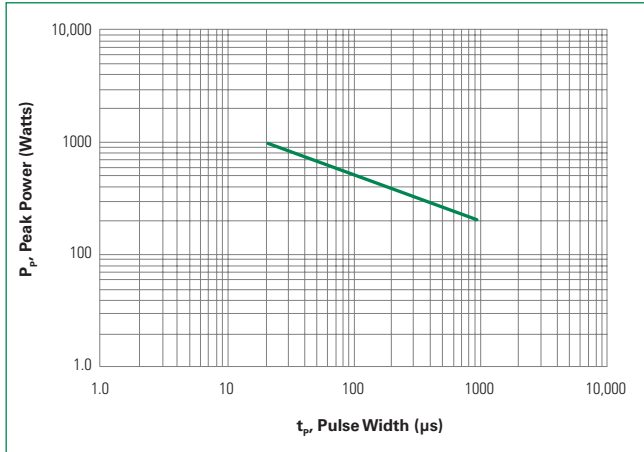
### I-V Curve Characteristics ( $T_A = 25^\circ\text{C}$ unless otherwise noted, $V_F = 3.5$ V Max. @ $I_F$ (Note 4) = 12 A)



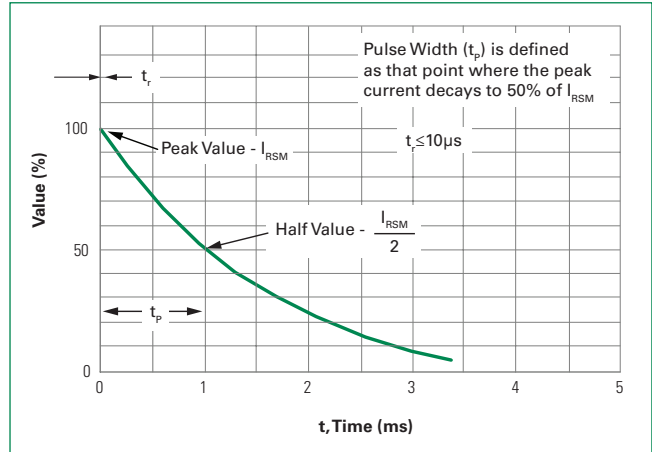
Symbol	Parameter
$I_{PP}$	Maximum Reverse Peak Pulse Current
$V_C$	Clamping Voltage @ $I_{PP}$
$V_{RWM}$	Working Peak Reverse Voltage
$I_R$	Maximum Reverse Leakage Current @ $V_{RWM}$
$V_{BR}$	Breakdown Voltage @ $I_T$
$I_T$	Test Current
$I_F$	Forward Current
$V_F$	Forward Voltage @ $I_F$

**Ratings and Characteristic Curves**

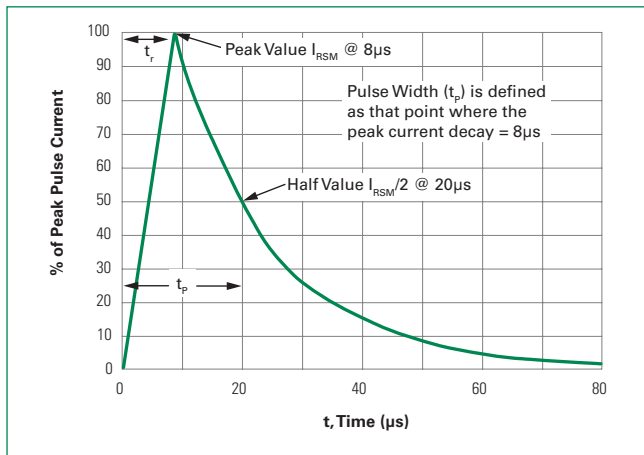
**Figure 1. Pulse Rating Curve**



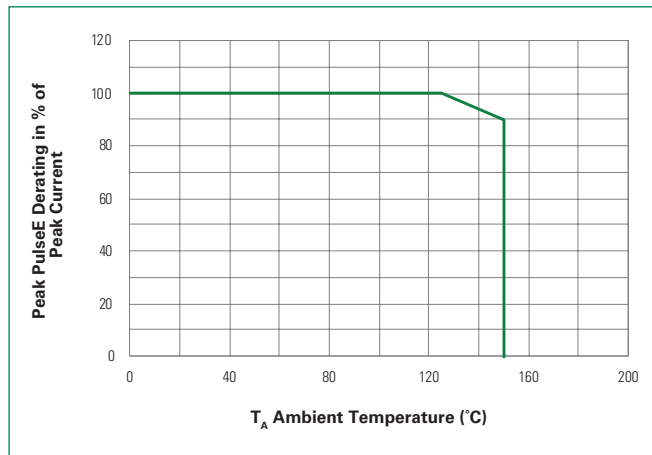
**Figure 2. 10/1000 µs Pulse Waveform**



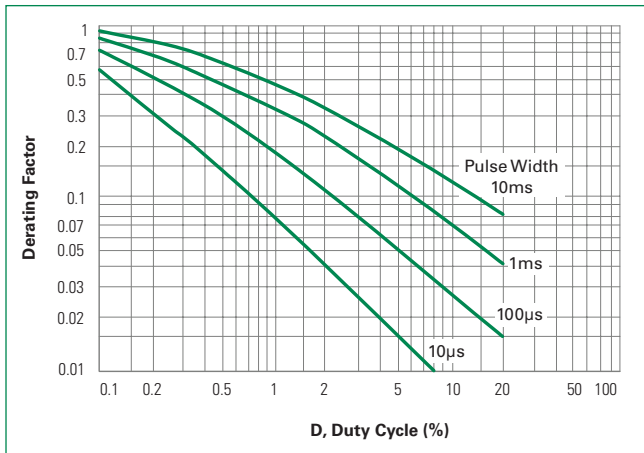
**Figure 3. 8/20 µs Pulse Waveform**



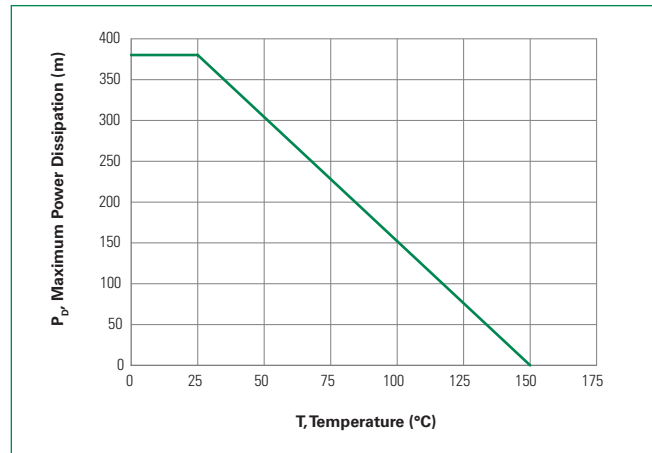
**Figure 4. Surge Derating Curve**



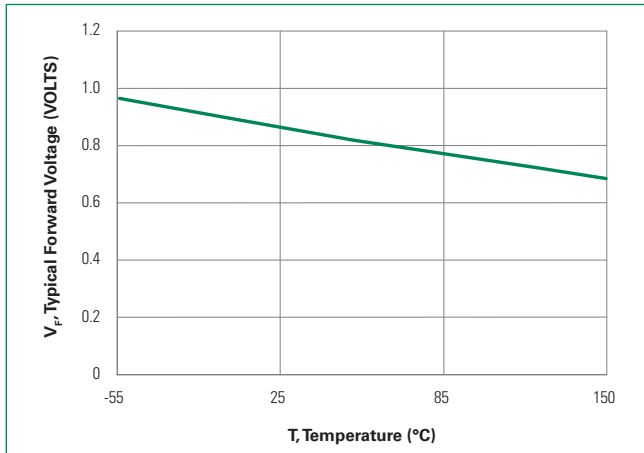
**Figure 5. Typical Derating Factor for Duty Cycle**



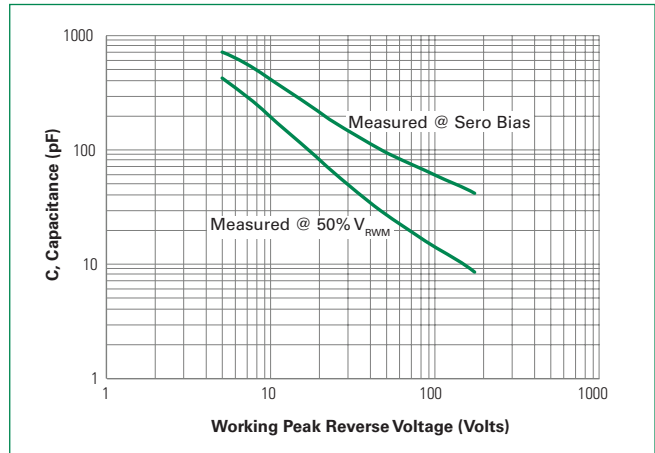
**Figure 6. Steady State Power Derating**



**Figure 7. Forward Voltage**

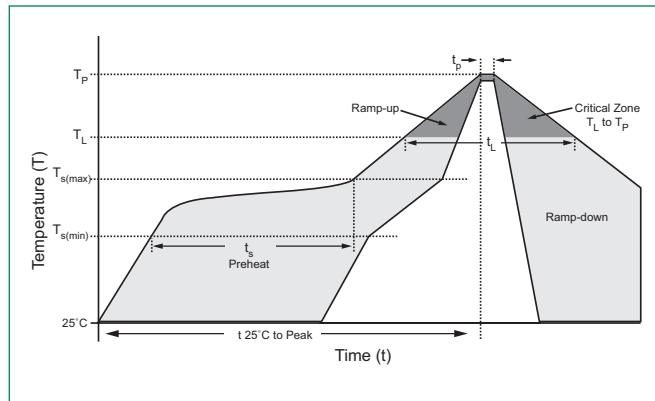


**Figure 8. Capacitance vs. Working Peak Reverse Voltage**



**Soldering Parameters**

Reflow Condition		Lead-free assembly
Pre Heat	- Temperature Min ( $T_{s(min)}$ )	150°C
	- Temperature Max ( $T_{s(max)}$ )	200°C
	- Time (min to max) ( $t_s$ )	60 – 120 secs
Average ramp up rate (Liquidus Temp ( $T_L$ ) to peak)		3°C/second max
$T_{s(max)}$ to $T_L$ - Ramp-up Rate		3°C/second max
Reflow	- Temperature ( $T_L$ ) (Liquidus)	217°C
	- Time (min to max) ( $t_L$ )	60 – 150 seconds
Peak Temperature ( $T_p$ )		260 <sup>+0/-5</sup> °C
Time within 5°C of actual peak Temperature ( $t_p$ )		30 seconds max
Ramp-down Rate		6°C/second max
Time 25°C to peak Temperature ( $T_p$ )		8 minutes Max.
Do not exceed		260°C



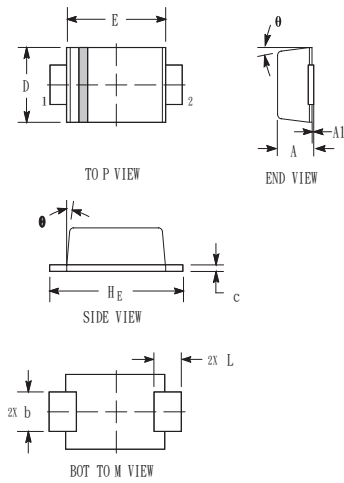
**Physical Specifications**

<b>Weight</b>	0.004 ounce ,0.0116 grams
<b>Case</b>	JEDEC SOD-123FL. Void-free, transfer-molded, thermosetting plastic epoxy meets UL 94V-0
<b>Polarity</b>	Color band denotes positive end (cathode) except Bidirectional.
<b>Terminal</b>	Matte Tin-plated leads, Solderable per JESD22-B102

**Environmental Specifications**

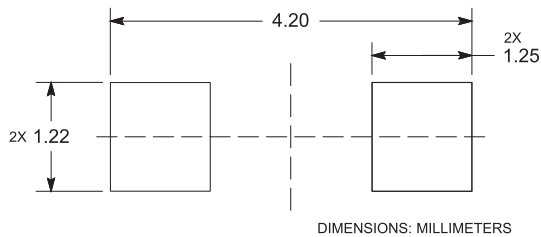
<b>High Temp. Storage</b>	JESD22-A103
<b>HTRB</b>	JESD22-A108
<b>Temperature Cycling</b>	JESD22-A104
<b>MSL</b>	JEDEC-J-STD-020, Level 1
<b>H3TRB</b>	JESD22-A101
<b>RSH</b>	JESD22-A111

**Dimensions**



Dim	Millimeters			Inches		
	Min	Nom	Max	Min	Nom	Max
A	0.90	0.95	0.98	0.035	0.037	0.039
A1	0.00	0.05	0.10	0.000	0.002	0.004
b	0.70	0.90	1.10	0.028	0.035	0.043
c	0.10	0.15	0.20	0.004	0.006	0.008
D	1.50	1.65	1.80	0.059	0.065	0.071
E	2.50	2.70	2.90	0.098	0.106	0.114
L	0.55	0.75	0.95	0.022	0.030	0.037
H <sub>E</sub>	3.40	3.60	3.80	0.134	0.142	0.150
Θ	0°	-	8°	0°	-	8°

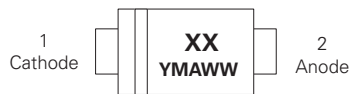
**Soldering Footprint**



**Ordering Information**

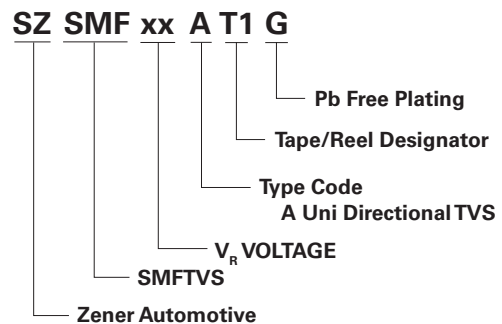
Device	Package	Shipping
SZSMFxxxAT1G	SOD-123FL (Pb-Free)	3,000 / Tape & Reel

**Part Marking System**

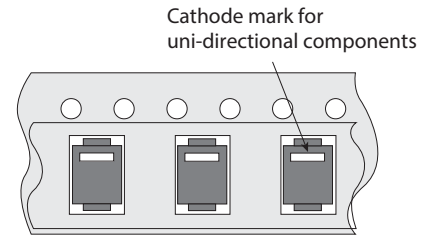
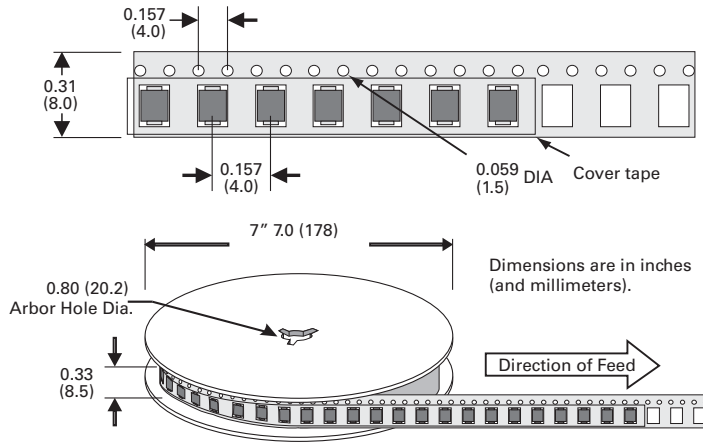


XX = Device Code  
Y = Year  
M = Month  
A = Assembly Location  
WW = Lot Code

**Part Numbering System**



**Tape and Reel Specification**



**Disclaimer Notice** - Information furnished is believed to be accurate and reliable. However, users should independently evaluate the suitability of and test each product selected for their own applications. Littelfuse products are not designed for, and may not be used in, all applications. Read complete Disclaimer Notice at: [www.littelfuse.com/disclaimer-electronics](http://www.littelfuse.com/disclaimer-electronics).

## Looking for pricing, stock, or lifecycle information?

Click below to explore more details on WIN SOURCE:

 [View SZSMF10AT1G on WIN SOURCE](#)

 [Littelfuse Inc. Information](#)

## Optimize Your Supply Chain with WIN SOURCE Solutions

-  Global Sourcing Solution
-  Obsolete Management
-  Cost Control Management
-  Shortage Management
-  Alternative Solution
-  Excess Inventory Management