



**THE DATASHEET OF
BU7325HFV-TR**



High-performance Clock Generator Series

Compact 1ch Clock Generators for Digital Cameras



BU3071HFV, BU3072HFV, BU3073HFV, BU3076HFV, BU7322HFV, BU7325HFV

No.09005EAT01

●Description

These Clock Generators incorporate compact package compared to oscillators, which provides the generation of high-frequency CCD, USB, VIDEO clocks necessary for digital still cameras and digital video cameras.

●Features

- 1) SEL pin allowing for the selection of frequencies
- 2) Selection of OE pin enabling Power-down function
- 3) Crystal-oscillator-level clock precision with high C/N characteristics and low jitter
- 4) Micro miniature HVSO6 Package incorporated
- 5) Single power supply of 3.3 V

●Applications

Digital Still Camera, Digital Video Camera, and others

●Lineup

| Parameter | BU3071HFV | BU3072HFV | BU3073HFV | BU3076HFV | BU7322HFV | BU7325HFV |
|-----------------------------|--------------|--------------|--------------|---------------|---------------|---------------|
| Supply voltage | 3.0 V ~ 3.6V | 3.0 V ~ 3.6V | 3.0 V ~ 3.6V | 2.85 V ~ 3.6V | 2.85 V ~ 3.6V | 2.85 V ~ 3.6V |
| Operating temperature range | -5°C ~ 70°C | -5°C ~ 70°C | -5°C ~ 70°C | -5°C ~ 75°C | -5°C ~ 75°C | -30°C ~ 85°C |
| Reference input clock | 28.6363MHz | 48.0000MHz | 48.0000MHz | 27.0000MHz | 27.0000MHz | 27.0000MHz |
| Output clock | 54.0000MHz | 27.0000MHz | 24.3750MHz | 54.0000MHz | 49.5000MHz | 48.0000MHz |
| | - | 36.0000MHz | 24.5454MHz | 67.5000MHz | 36.0000MHz | 78.0000MHz |
| Power-down function | Provided | Provided | Provided | Provided | Provided | Provided |
| Operating current (Typ.) | 10mA | 11mA | 11mA | 12mA | 10mA | 12mA |
| Package | HVSO6 | HVSO6 | HVSO6 | HVSO6 | HVSO6 | HVSO6 |

●Absolute Maximum Ratings(Ta=25°C)

| Parameter | Symbol | Ratings | Unit |
|---------------------------|--------|----------------|------|
| Supply voltage | VDD | -0.3 ~ 4.0 | V |
| Input voltage | VIN | -0.3 ~ VDD+0.3 | V |
| Storage temperature range | Tstg | -30 ~ 125 | °C |
| Power dissipation | Pd | 410 | mW |

*1 Operating is not guaranteed.

*2 In the case of exceeding Ta = 25°C, 4.1mW should be reduced per 1°C.

*3 The radiation-resistance design is not carried out.

*4 Power dissipation is measured when the IC is mounted to the printed circuit board.

●Recommended Operating Range

| Parameter | Symbol | Limits | Unit |
|-----------------------|--------|--------------|------|
| Supply voltage | VDD | 3.0 ~ 3.6 | V |
| Input H voltage | VINH | 0.8VDD ~ VDD | V |
| Input L voltage | VINL | 0.0 ~ 0.2VDD | V |
| Operating temperature | Topr | -5 ~ 70 | °C |
| Output load | CL | 15(MAX) | pF |

●Electrical Characteristics

BU3071HFV (Ta=25°C, VDD=3.3V, Crystal frequency=28.6363MHz, unless otherwise specified.)

| Parameter | Symbol | Limits | | | Unit | Conditions |
|---|--------|--------|---------|------|------|---|
| | | Min. | Typ. | Max. | | |
| Output H voltage | VOH | 2.8 | - | - | V | IOH=-4.0mA |
| Output L voltage | VOL | - | - | 0.5 | V | IOL=4.0mA |
| Consumption current 1 | IDD1 | - | 10 | 15 | mA | OE=H, at no load |
| Consumption current 2 | IDD2 | - | 1 | 1.3 | mA | OE=L |
| Output frequency | | - | 54.0000 | - | MHz | IN*264/35/4 |
| The following parameters represent design guaranteed performance. | | | | | | |
| Duty | Duty | 45 | 50 | 55 | % | Measured at a voltage of 1/2 of VDD |
| Period-Jitter 1σ | PJsSD | - | 50 | - | psec | ※1 |
| Period-Jitter MIN-MAX | PJsABS | - | 300 | - | psec | ※2 |
| Rise time | tr | - | 2.5 | - | nsec | Period of transition time required for the output to reach 80% from 20% of VDD. Provided with 15pF output load. |
| Fall time | tf | - | 2.5 | - | nsec | Period of transition time required for the output to reach 20% from 80% of VDD. Provided with 15pF output load. |
| Output Lock time | tLOCK | - | - | 1 | msec | ※3 |

Note) The output frequency is determined by the arithmetic (frequency division) expression of a frequency input to IN.
If the input frequency is set to 28.6363MHz, the output frequency will be as listed above.

BU3072HFV (Ta=25°C, VDD=3.3V, Crystal frequency=48.0000MHz, unless otherwise specified.)

| Parameter | Symbol | Limits | | | Unit | Conditions |
|---|---------|--------|---------|------|------|---|
| | | Min. | Typ. | Max. | | |
| Output H voltage | VOH | 2.8 | - | - | V | IOH=-4.0mA |
| Output L voltage | VOL | - | - | 0.5 | V | IOL=4.0mA |
| Consumption current 1 | IDD1 | - | 11 | 16 | mA | PD=H, at no load |
| Consumption current 2 | IDD2 | - | - | 5 | μA | PD=L |
| Output frequency | CLK_27 | - | 27.0000 | - | MHz | SEL=L, IN*18/8/4 |
| | CLK_36 | - | 36.0000 | - | MHz | SEL=H, IN*24/8/4 |
| The following parameters represent design guaranteed performance. | | | | | | |
| Duty | Duty | 45 | 50 | 55 | % | Measured at a voltage of 1/2 of VDD |
| Period-Jitter 1σ | PJsSD | - | 35 | - | psec | ※1 |
| Long-Term-Jitter MIN-MAX | LTJsABS | - | 0.9 | 1.5 | nsec | MIN-MAX of long-term jitter (100 μsec from trigger) |
| Rise time | tr | - | 2.5 | - | nsec | Period of transition time required for the output to reach 80% from 20% of VDD. Provided with 15pF output load. |
| Fall time | tf | - | 2.5 | - | nsec | Period of transition time required for the output to reach 20% from 80% of VDD. Provided with 15pF output load. |
| Output Lock time | tLOCK | - | - | 1 | msec | ※3 |

Note) The output frequency is determined by the arithmetic (frequency division) expression of a frequency input to IN.
If the input frequency is set to 48.0000MHz, the output frequency will be as listed above.

BU3073HFV(Ta=25°C, VDD=3.3V, Crystal frequency=48.0000MHz, unless otherwise specified.)

| Parameter | Symbol | Limits | | | Unit | Conditions |
|---|---------|--------|---------|------|------|---|
| | | Min. | Typ. | Max. | | |
| Output H voltage | VOH | 2.8 | - | - | V | IOH=-4.0mA |
| Output L voltage | VOL | - | - | 0.5 | V | IOL=4.0mA |
| Consumption current 1 | IDD1 | - | 11 | 16 | mA | PD=H, at no load |
| Consumption current 2 | IDD2 | - | - | 5 | mA | PD=L |
| Output frequency | CLK_375 | - | 24.3750 | - | MHz | SEL=L, IN*65/16/8 |
| | CLK_545 | - | 24.5454 | - | MHz | SEL=H, IN*45/11/8 |
| The following parameters represent design guaranteed performance. | | | | | | |
| Duty | Duty | 45 | 50 | 55 | % | Measured at a voltage of 1/2 of VDD |
| Period-Jitter 1σ | PJsSD | - | 45 | - | psec | ※1 |
| Long-Term-Jitter MIN-MAX | LTJsABS | - | 0.9 | 1.5 | nsec | MIN-MAX of long-term jitter (100 μsec from trigger) |
| Rise time | tr | - | 2.5 | - | nsec | Period of transition time required for the output to reach 80% from 20% of VDD. Provided with 15pF output load. |
| Fall time | tf | - | 2.5 | - | nsec | Period of transition time required for the output to reach 20% from 80% of VDD. Provided with 15pF output load. |
| Output Lock time | tLOCK | - | - | 1 | msec | ※3 |

Note) The output frequency is determined by the arithmetic (frequency division) expression of a frequency input to IN.
If the input frequency is set to 48.0000MHz, the output frequency will be as listed above.

BU3076HFV(Ta=25°C, VDD=3.3V, Crystal frequency=27.0000MHz, unless otherwise specified.)

| Parameter | Symbol | Limits | | | Unit | Conditions |
|---|----------|--------|---------|------|------|---|
| | | Min. | Typ. | Max. | | |
| Output H voltage | VOH | 2.8 | - | - | V | IOH=-4.0mA |
| Output L voltage | VOL | - | - | 0.5 | V | IOL=4.0mA |
| Pull-down resistance | Rpd | 25 | 50 | 100 | KΩ | Pull-down resistance on input pin |
| Consumption current 1 | IDD1 | - | 10 | 15 | mA | 54MHz output, at no load |
| Consumption current 2 | IDD2 | - | 12 | 18 | mA | 67.5MHz output, at no load |
| Standby current | IDDst | - | - | 1 | μA | OE=L |
| Output frequency | CLK_54 | - | 54.0000 | - | MHz | SEL=L, IN*48/6/4 |
| | CLK_67.5 | - | 67.5000 | - | MHz | SEL=H, IN*60/6/4 |
| The following parameters represent design guaranteed performance. | | | | | | |
| Duty | Duty | 45 | 50 | 55 | % | Measured at a voltage of 1/2 of VDD |
| Period-Jitter 1σ | PJsSD | - | 50 | - | psec | ※1 |
| Period-Jitter MIN-MAX | PJsABS | - | 300 | - | psec | ※2 |
| Rise time | tr | - | 1.5 | - | nsec | Period of transition time required for the output to reach 80% from 20% of VDD. Provided with 15pF output load. |
| Fall time | tf | - | 1.5 | - | nsec | Period of transition time required for the output to reach 20% from 80% of VDD. Provided with 15pF output load. |
| Output Lock time | tLOCK | - | - | 200 | μsec | ※3 |

Note) The output frequency is determined by the arithmetic (frequency division) expression of a frequency input to IN.
If the input frequency is set to 27.0000MHz, the output frequency will be as listed above.

BU7322HFV (Ta=25°C, VDD=3.3V, Crystal frequency=27.0000MHz, unless otherwise specified.)

| Parameter | Symbol | Limits | | | Unit | Conditions |
|-----------------------|----------|--------|---------|------|------|-----------------------------------|
| | | Min. | Typ. | Max. | | |
| Output H voltage | VOH | 2.8 | - | - | V | IOH=-4.0mA |
| Output L voltage | VOL | - | - | 0.5 | V | IOL=4.0mA |
| Pull-down resistance | Rpd | 25 | 50 | 100 | kΩ | Pull-down resistance on input pin |
| Consumption current 1 | IDD | - | 10 | 13.5 | mA | 49.5MHz output, at no load |
| Consumption current 2 | IDD2 | - | 9.5 | 13.0 | mA | 36.0MHz output, at no load |
| Standby current | IDDst | - | - | 1 | μA | OE=L |
| Output frequency | CLK_49.5 | - | 49.5000 | - | MHz | SEL=L, IN*66/6/6 |
| | CLK_36 | - | 36.0000 | - | MHz | SEL=H, IN*64/6/8 |

The following parameters represent design guaranteed performance.

| | | | | | | |
|-----------------------|--------|----|-----|-----|------|---|
| Duty | Duty | 45 | 50 | 55 | % | Measured at a voltage of 1/2 of VDD |
| Period-Jitter 1σ | PJsSD | - | 50 | - | psec | ※1 |
| Period-Jitter MIN-MAX | PJsABS | - | 300 | - | psec | ※2 |
| Rise time | tr | - | 2.5 | - | nsec | Period of transition time required for the output to reach 80% from 20% of VDD. Provided with 15pF output load. |
| Fall time | tf | - | 2.5 | - | nsec | Period of transition time required for the output to reach 20% from 80% of VDD. Provided with 15pF output load. |
| Output Lock time | tLOCK | - | - | 200 | μsec | ※3 |

Note) The output frequency is determined by the arithmetic (frequency division) expression of a frequency input to IN.
If the input frequency is set to 27.0000MHz, the output frequency will be as listed above.

BU7325HFV (Ta=25°C, VDD=3.3V, Crystal frequency=27.0000MHz, unless otherwise specified.)

| Parameter | Symbol | Limits | | | Unit | Conditions |
|-----------------------|--------|--------|---------|------|------|-----------------------------------|
| | | Min. | Typ. | Max. | | |
| Output H voltage | VOH | 2.8 | - | - | V | IOH=-4.0mA |
| Output L voltage | VOL | - | - | 0.5 | V | IOL=4.0mA |
| Pull-down resistance | Rpd | 25 | 50 | 100 | kΩ | Pull-down resistance on input pin |
| Consumption current 1 | IDD1 | - | 11 | 15 | mA | OE=H, SEL=L, at no load |
| Consumption current 2 | IDD2 | - | 12 | 16.5 | mA | OE=H, SEL=H, at no load |
| Standby current | IDDst | - | - | 1 | μA | OE=L |
| Output frequency | CLK_48 | - | 48.0000 | - | MHz | SEL=L, IN*96/9/6 |
| | CLK_78 | - | 78.0000 | - | MHz | SEL=H, IN*104/9/4 |

The following parameters represent design guaranteed performance.

| | | | | | | |
|-----------------------|--------|----|-----|-----|------|---|
| Duty | Duty | 45 | 50 | 55 | % | Measured at a voltage of 1/2 of VDD |
| Period-Jitter 1σ | PJsSD | - | 50 | - | psec | ※1 |
| Period-Jitter MIN-MAX | PJsABS | - | 300 | - | psec | ※2 |
| Rise time | tr | - | 1.5 | - | nsec | Period of transition time required for the output to reach 80% from 20% of VDD. Provided with 15pF output load. |
| Fall time | tf | - | 1.5 | - | nsec | Period of transition time required for the output to reach 20% from 80% of VDD. Provided with 15pF output load. |
| Output Lock time | tLOCK | - | - | 200 | μsec | ※3 |

Note) The output frequency is determined by the arithmetic (frequency division) expression of a frequency input to IN.
If the input frequency is set to 27.0000MHz, the output frequency will be as listed above.

Common to BU3071HFV, BU3072HFV, BU3073HFV, BU3076HFV, BU7322HFV, BU7325HFV

- ※1 Period-Jitter 1σ
This parameter represents standard deviation (=1σ) on cycle distribution data at the time when the output clock cycles are sampled 1000 times consecutively with the TDS7104 Digital Phosphor Oscilloscope of Tektronix Japan, Ltd.
- ※2 Period-Jitter MIN-MAX
This parameter represents a maximum distribution width on cycle distribution data at the time when the output clock cycles are sampled 1000 times consecutively with the TDS7104 Digital Phosphor Oscilloscope of Tektronix Japan, Ltd.
- ※3 Output Lock Time
This parameter represents elapsed time after power supply turns ON to reach a voltage of 3.0 V, after the system is switched from Power-Down state to normal operation state, or after the output frequency is switched, until it is stabilized at a specified frequency, respectively.

●Reference data (BU3071HFV basic data)

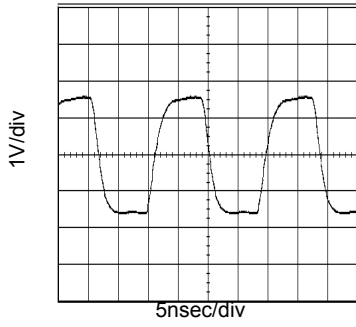

Fig.1 54MHz output waveform
(VDD=3.3V, CL=15pF, Ta=25°C)

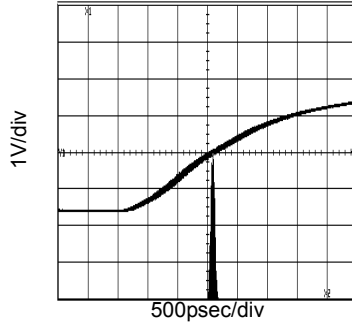

Fig.2 54MHz Period-Jitter
(VDD=3.3V, CL=15pF, Ta=25°C)

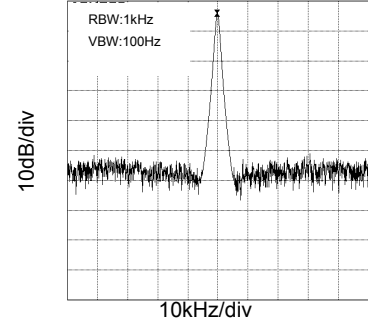

Fig.3 54MHz spectrum
(VDD=3.3V, CL=15pF, Ta=25°C)

●Reference data (BU3072HFV basic data)

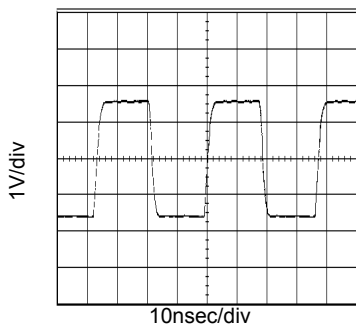

Fig.4 27MHz output waveform
(VDD=3.3V, CL=15pF, Ta=25°C)

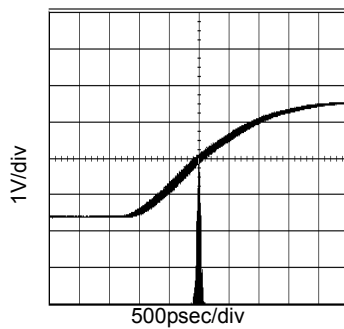

Fig.5 27MHz Period-Jitter
(VDD=3.3V, CL=15pF, Ta=25°C)

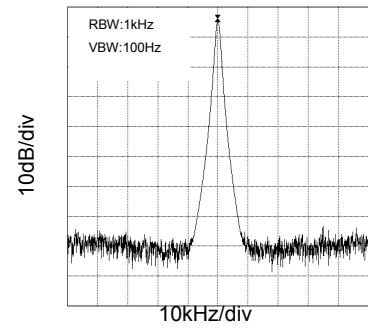

Fig.6 27MHz spectrum
(VDD=3.3V, CL=15pF, Ta=25°C)

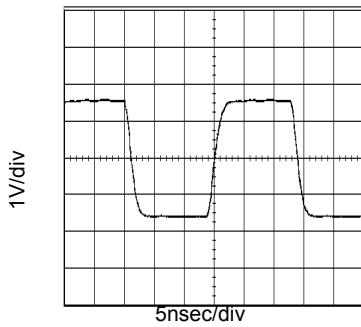

Fig.7 36MHz output waveform
(VDD=3.3V, CL=15pF, Ta=25°C)

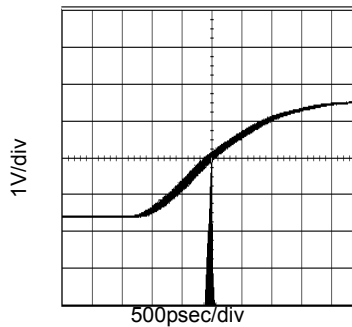

Fig.8 36MHz Period-Jitter
(VDD=3.3V, CL=15pF, Ta=25°C)

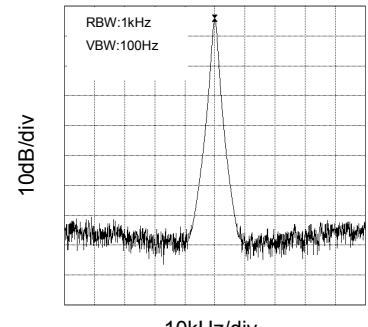

Fig.9 36MHz spectrum
(VDD=3.3V, CL=15pF, Ta=25°C)

●Reference data (BU3073HFV basic data)

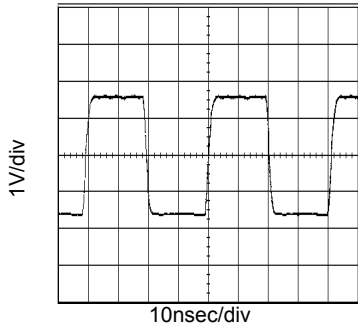

Fig.10 24.375MHz output waveform (VDD=3.3V, CL=15pF, Ta=25°C)

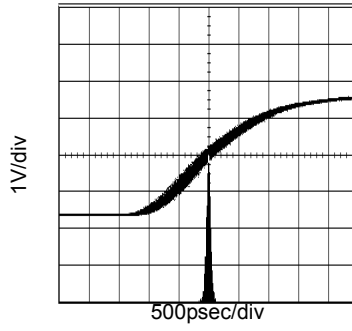

Fig.11 24.375MHz Period-Jitter (VDD=3.3V, CL=15pF, Ta=25°C)

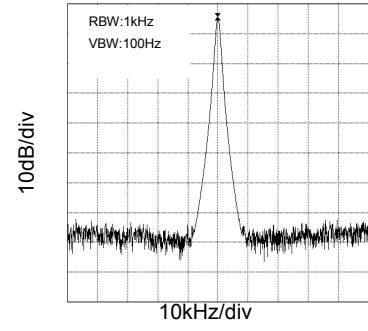

Fig.12 24.375MHz spectrum (VDD=3.3V, CL=15pF, Ta=25°C)

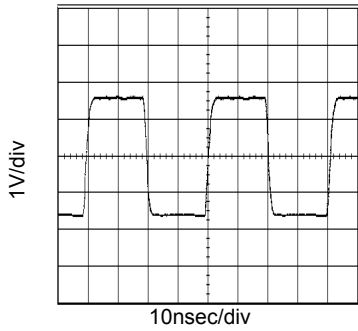

Fig.13 24.5454MHz output waveform (VDD=3.3V, CL=15pF, Ta=25°C)

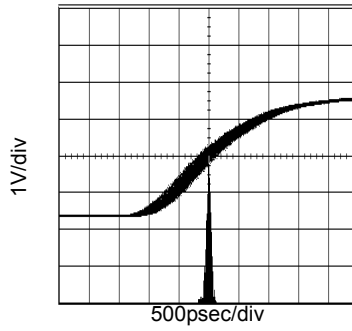

Fig.14 24.5454MHz Period-Jitter (VDD=3.3V, CL=15pF, Ta=25°C)

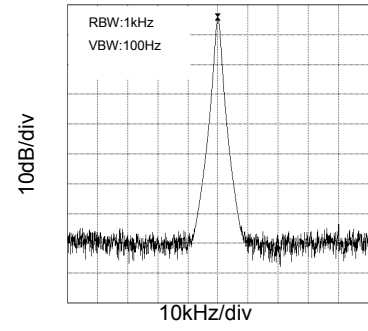

Fig.15 24.5454MHz spectrum (VDD=3.3V, CL=15pF, Ta=25°C)

●Reference data (BU3076HFV basic data)

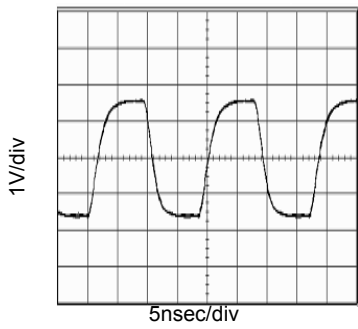

Fig.16 54MHz output waveform (VDD=3.3V, CL=15pF, Ta=25°C)

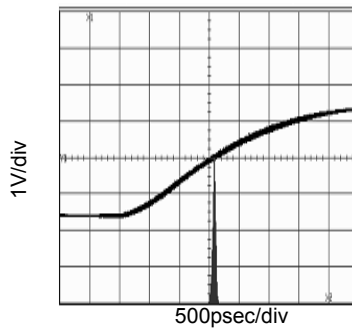

Fig.17 54MHz Period-Jitter (VDD=3.3V, CL=15pF, Ta=25°C)

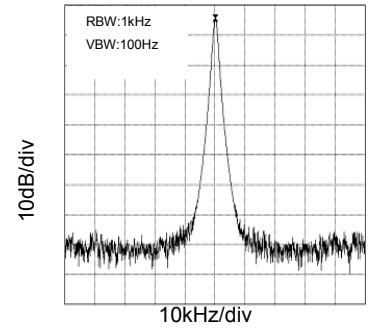

Fig.18 54MHz spectrum (VDD=3.3V, CL=15pF, Ta=25°C)

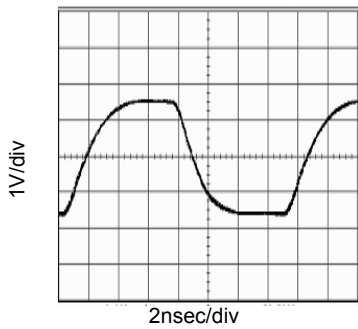

Fig.19 67.5MHz output waveform (VDD=3.3V, CL=15pF, Ta=25°C)

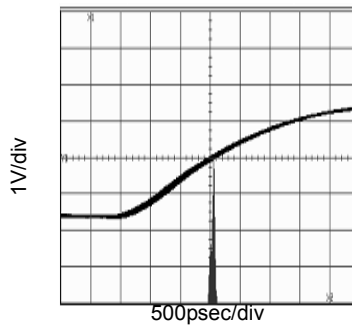

Fig.20 67.5MHz Period-Jitter (VDD=3.3V, CL=15pF, Ta=25°C)

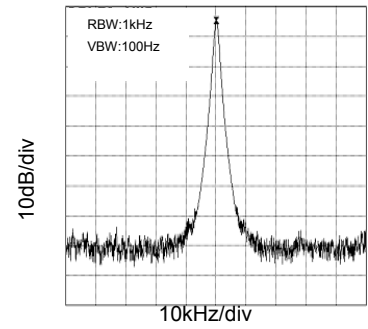

Fig.21 67.5MHz spectrum (VDD=3.3V, CL=15pF, Ta=25°C)

●Reference data (BU7322HFV basic data)

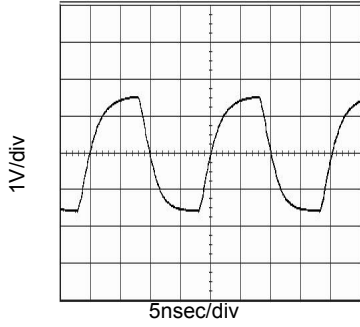

Fig.22 49.5MHz output waveform (VDD=3.3V, CL=15pF, Ta=25°C)

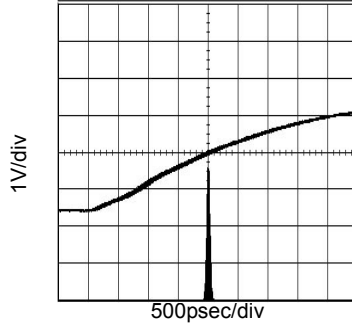

Fig.23 49.5MHz Period-Jitter (VDD=3.3V, CL=15pF, Ta=25°C)

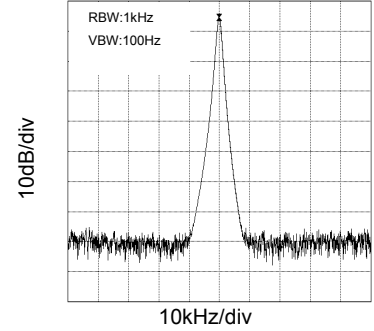

Fig.24 49.5MHz spectrum (VDD=3.3V, CL=15pF, Ta=25°C)

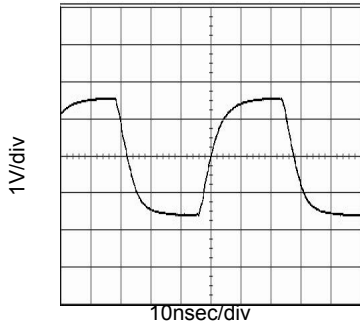

Fig.25 36MHz output waveform (VDD=3.3V, CL=15pF, Ta=25°C)

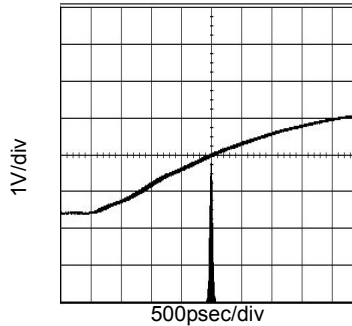

Fig.26 36MHz Period-Jitter (VDD=3.3V, CL=15pF, Ta=25°C)

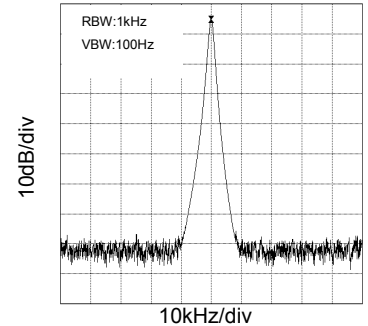

Fig.27 36MHz spectrum (VDD=3.3V, CL=15pF, Ta=25°C)

●Reference data (BU7325HFV basic data)

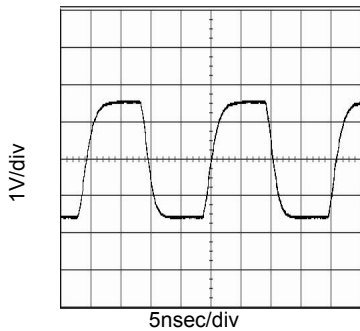

Fig.28 48MHz output waveform (VDD=3.3V, CL=15pF, Ta=25°C)

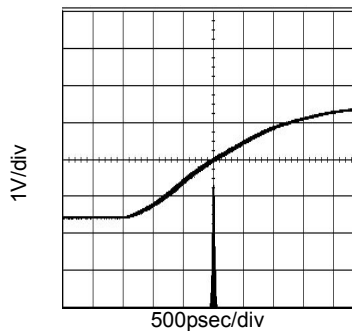

Fig.29 48MHz Period-Jitter (VDD=3.3V, CL=15pF, Ta=25°C)

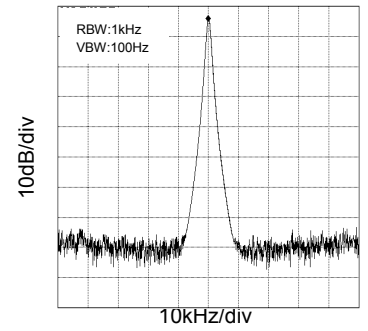

Fig.30 48MHz spectrum (VDD=3.3V, CL=15pF, Ta=25°C)

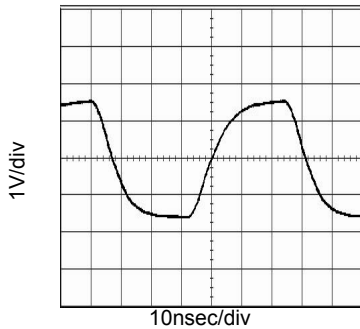

Fig.31 78MHz output waveform (VDD=3.3V, CL=15pF, Ta=25°C)

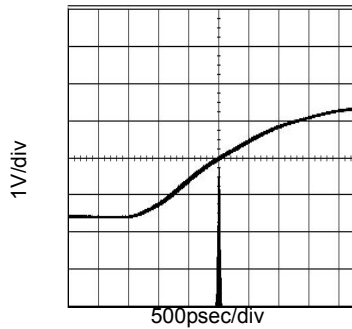

Fig.32 78MHz Period-Jitter (VDD=3.3V, CL=15pF, Ta=25°C)

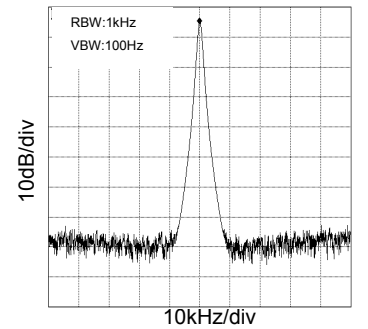

Fig.33 78MHz spectrum (VDD=3.3V, CL=15pF, Ta=25°C)

●Reference data (BU3071HFV Temperature and Supply voltage variations data)

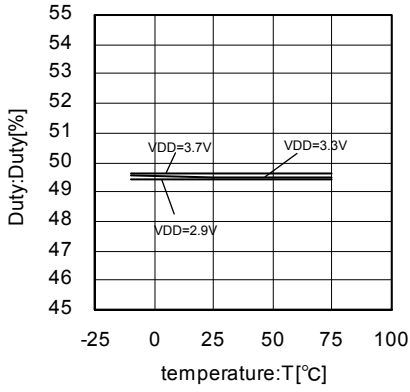

Fig.34 54MHz
Duty temperature characteristics

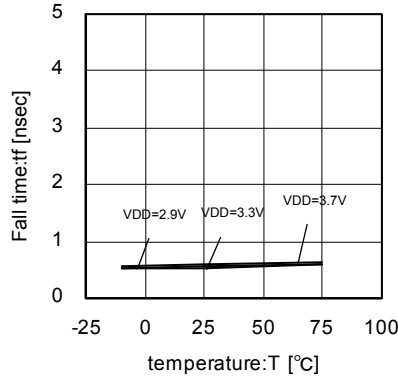

Fig.35 54MHz
Rise-time temperature characteristics

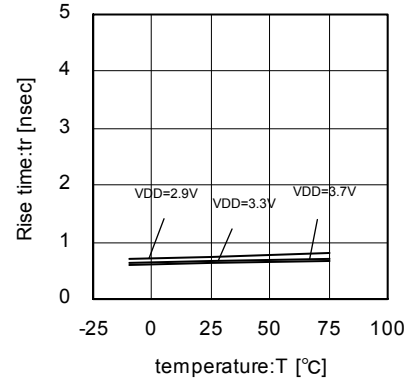

Fig.36 54MHz
Fall-time temperature characteristics

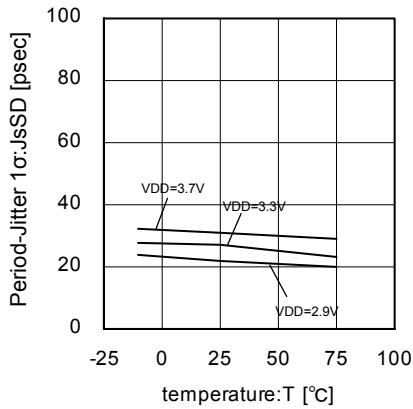

Fig.37 54MHz Period-Jitter 1σ
temperature characteristics

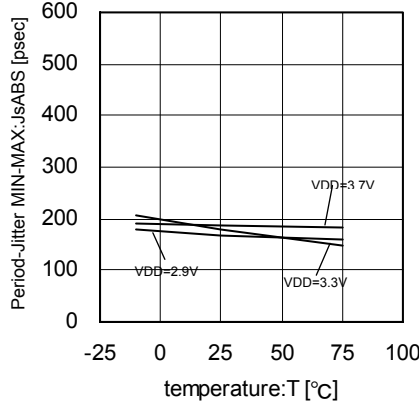

Fig.38 54MHz Jitter-Min Max
temperature characteristics

●Reference data (BU3072HFV Temperature and Supply voltage variations data)

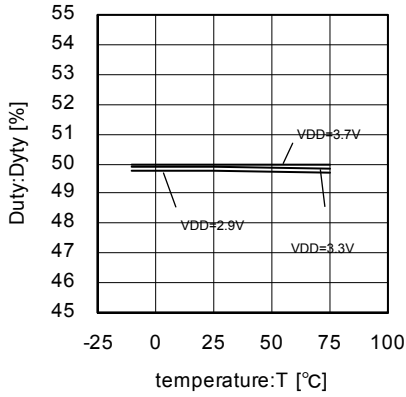

Fig.39 27MHz Duty temperature characteristics

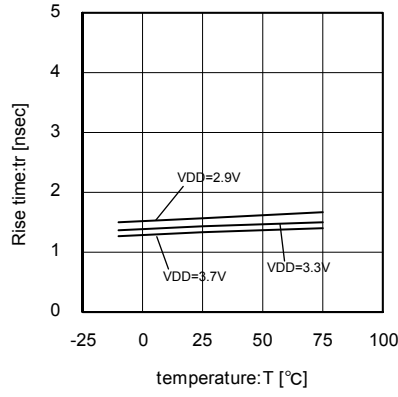

Fig.40 27MHz Rise-time temperature characteristics

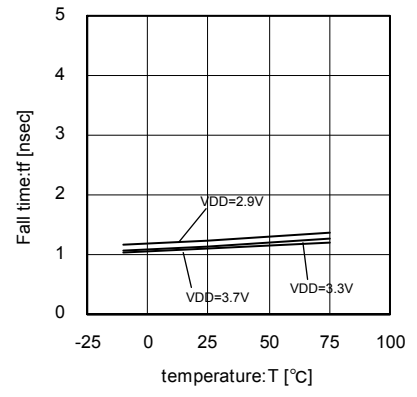

Fig.41 27MHz Fall-time temperature characteristics

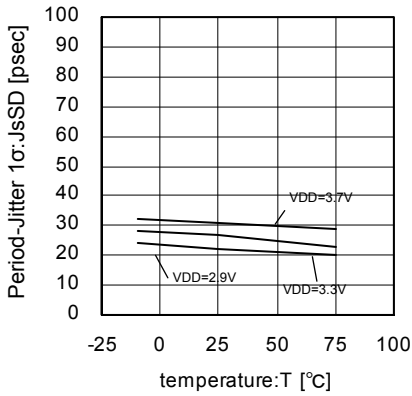

Fig.42 27MHz Period-Jitter 1σ temperature characteristics

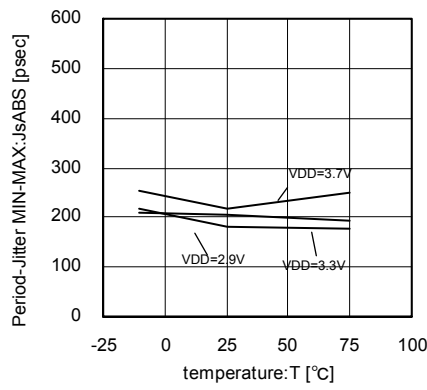

Fig.43 27MHz Jitter-MinMax temperature characteristics

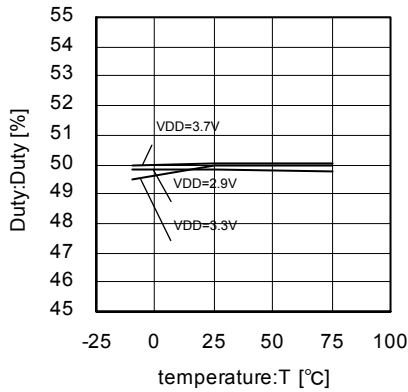

Fig.44 36MHz Duty temperature characteristic

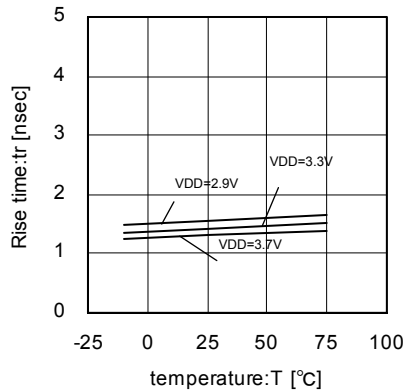

Fig.45 36MHz Rise-time temperature characteristics

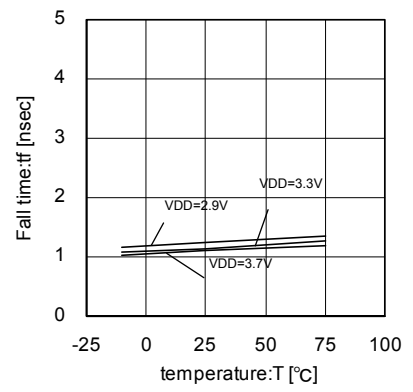

Fig.46 36MHz Fall-time temperature characteristics

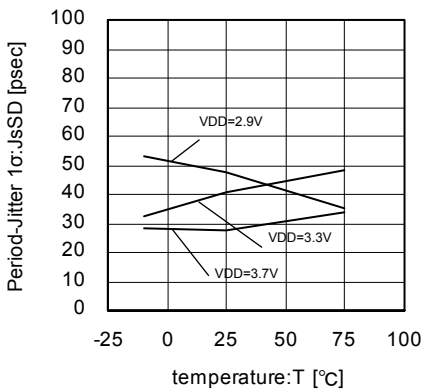

Fig.47 36MHz Period-Jitter 1σ temperature characteristic s

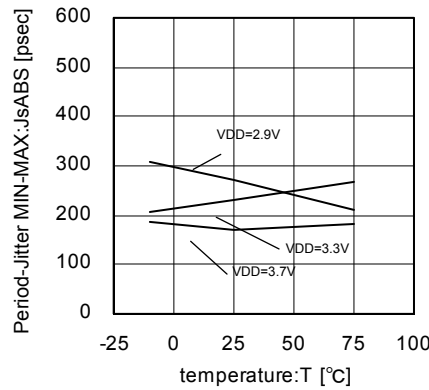

Fig.48 36MHz Jitter-Min Max temperature characteristics

●Reference data (BU3073HFV Temperature and Supply voltage variations data)

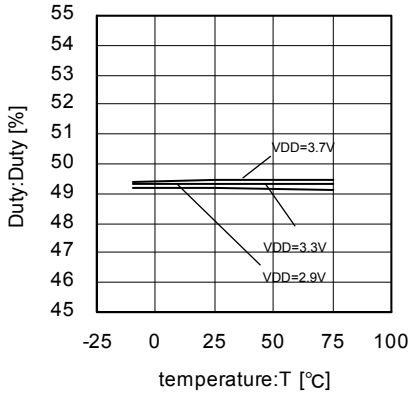

Fig.49 24.375MHz Duty temperature characteristics

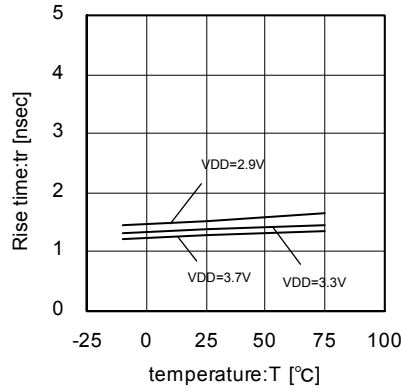

Fig.50 24.375MHz Rise-time temperature characteristics

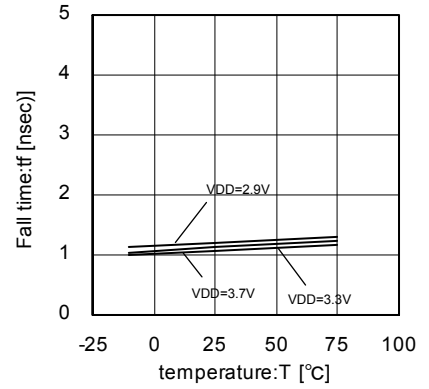

Fig.51 24.375MHz Fall-time temperature characteristics

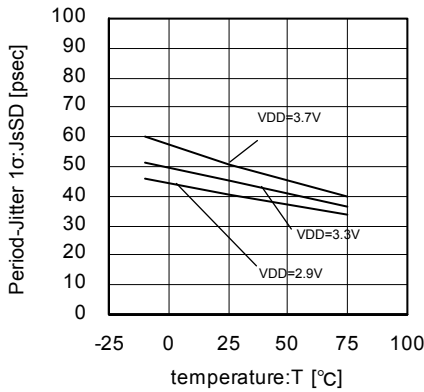

Fig.52 24.375MHz Period-Jitter 1σ temperature characteristics

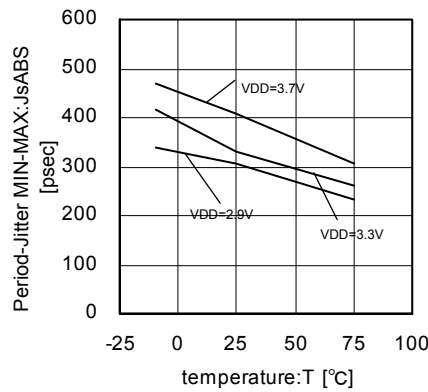

Fig.53 24.375MHz Jitter-Min Max temperature characteristics

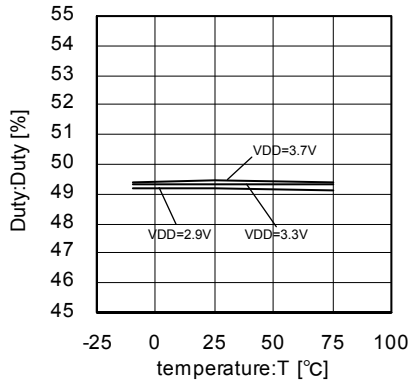

Fig.54 24.5454MHz Duty temperature characteristics

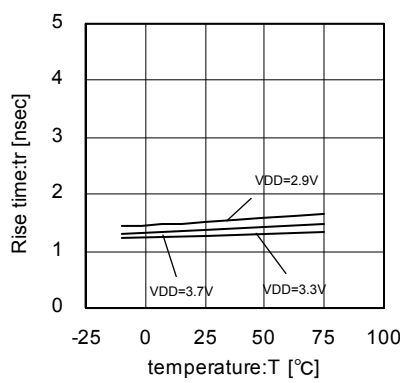

Fig.55 24.5454MHz Rise-time temperature characteristics

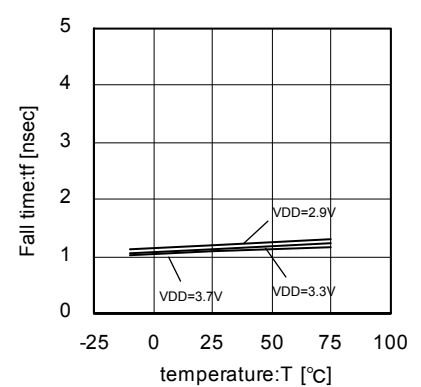

Fig.56 24.5454MHz Fall-time temperature characteristics

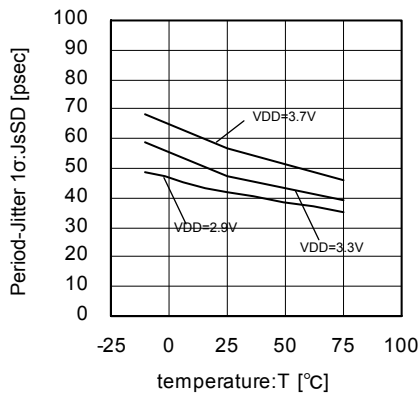

Fig.57 24.5454MHz Period-Jitter 1σ temperature characteristics

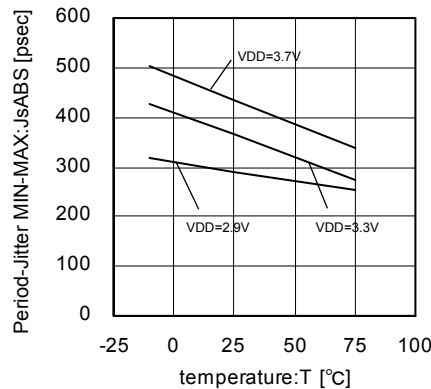

Fig.58 24.5454MHz Jitter-MinMax temperature characteristics

●Reference data (BU3076HFV Temperature and Supply voltage variations data)

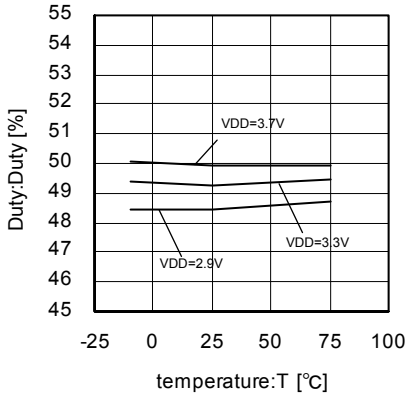

Fig.59 54MHz Duty temperature characteristics

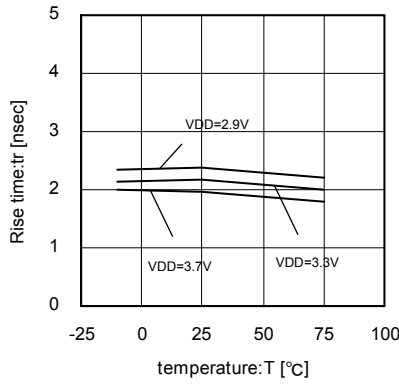

Fig.60 54MHz Rise-time temperature characteristics

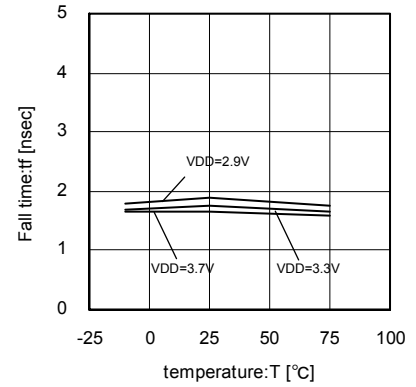

Fig.61 54MHz Fall-time temperature characteristics

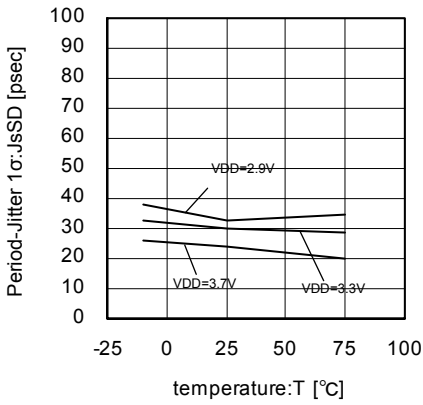

Fig.62 54MHz Period-Jitter 1σ temperature characteristics

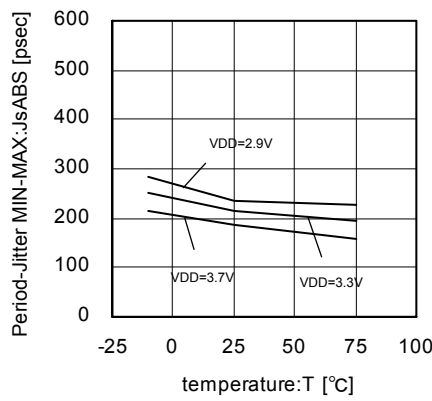

Fig.63 54MHz Jitter-Min Max temperature characteristics

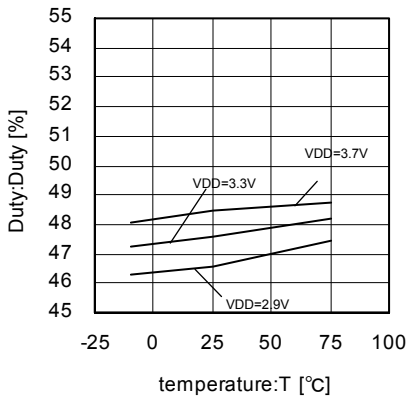

Fig.64 67.5MHz Duty temperature characteristics

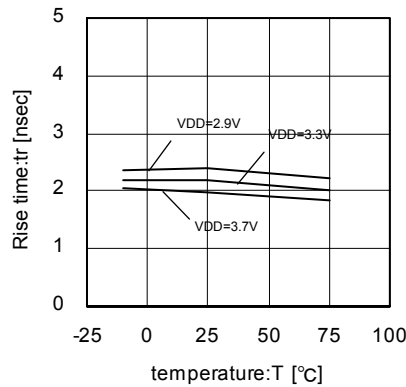

Fig.65 67.5MHz Rise-time temperature characteristics

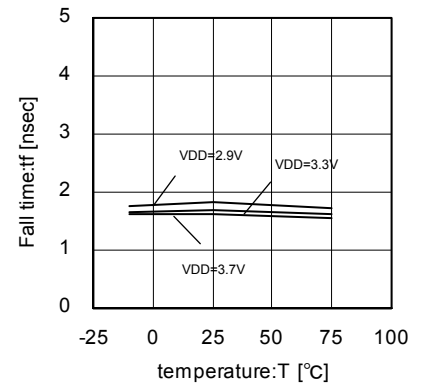

Fig.66 67.5MHz Fall-time temperature characteristics

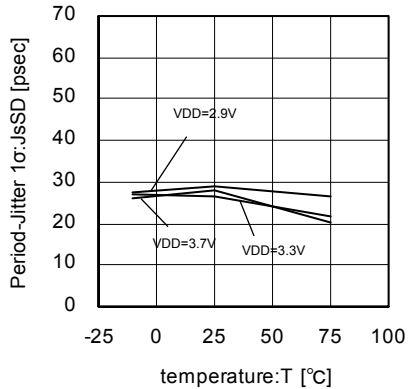

Fig.67 67.5MHz Period-Jitter 1σ temperature characteristics

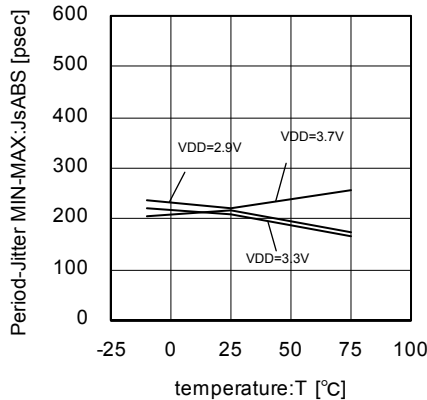

Fig.68 67.5MHz Jitter-MinMax temperature characteristics

●Reference data (BU7322HFV Temperature and Supply voltage variations data)

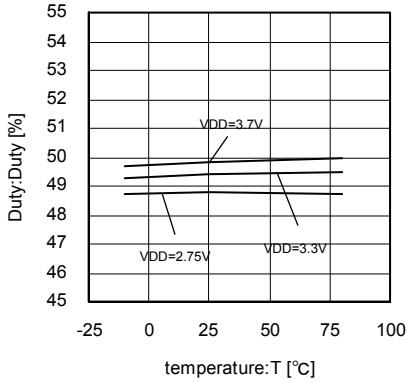

Fig.69 49.5MHz Duty temperature characteristics

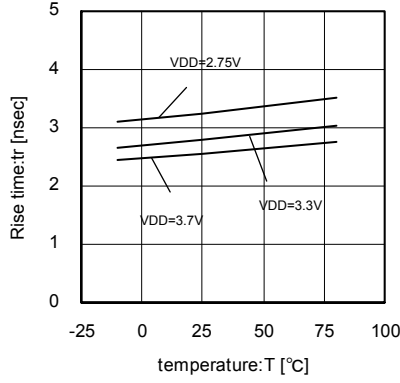

Fig.70 49.5MHz Rise-time temperature characteristics

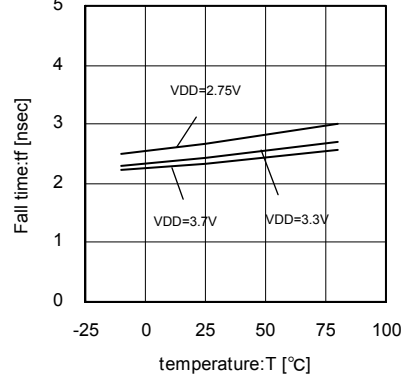

Fig.71 49.5MHz Fall-time temperature characteristics

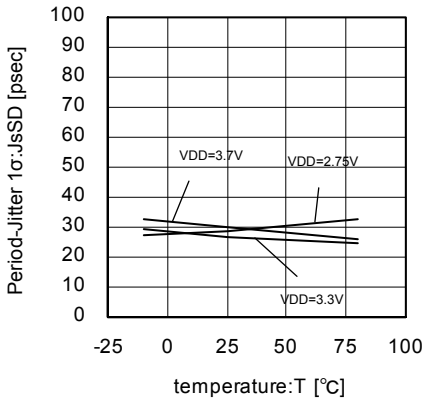

Fig.72 49.5MHz Period-Jitter 1σ temperature characteristics

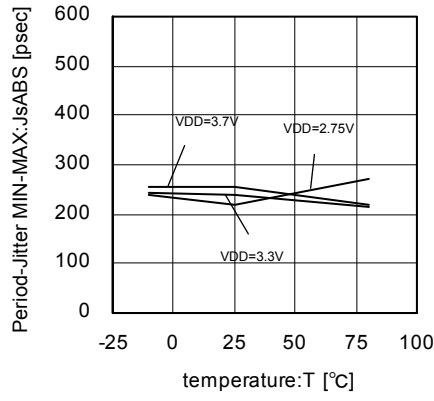

Fig.73 49.5MHz Jitter-Min Max temperature characteristics

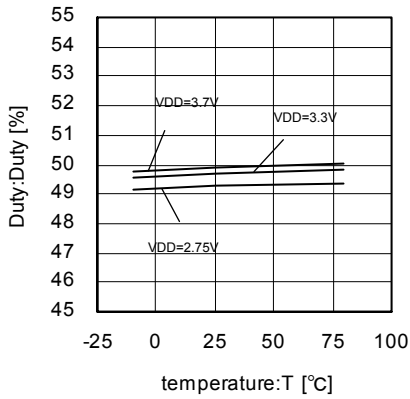

Fig.74 36MHz Duty temperature characteristics

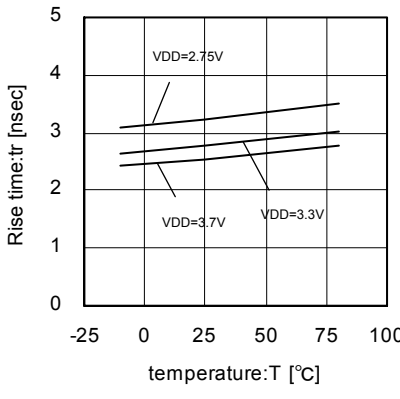

Fig.75 36MHz Rise-time temperature characteristics

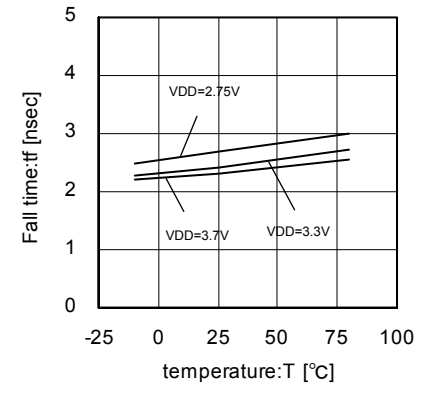

Fig.76 36MHz Fall-time temperature characteristics

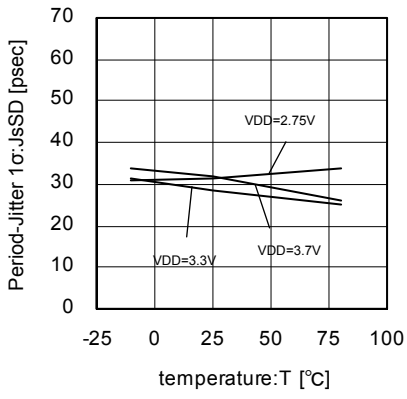

Fig.77 36MHz Period-Jitter 1σ temperature characteristics

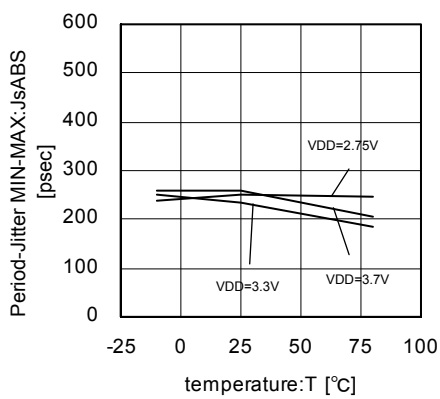

Fig.78 36MHz Jitter-MinMax temperature characteristics

●Reference data (BU7325HFV Temperature and Supply voltage variations data)

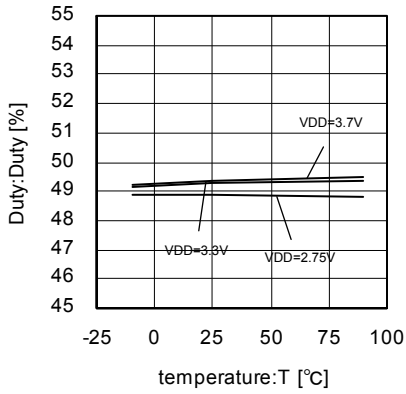

Fig.79 48MHz

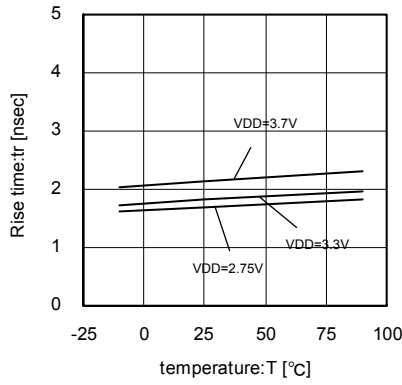

Fig.80 48MHz

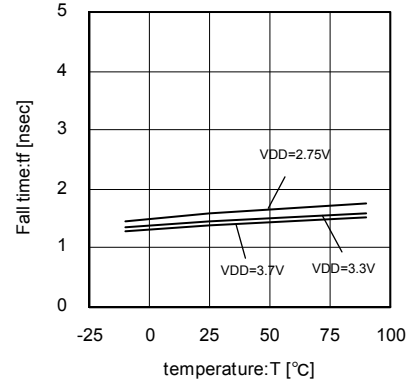

Fig.81 48MHz

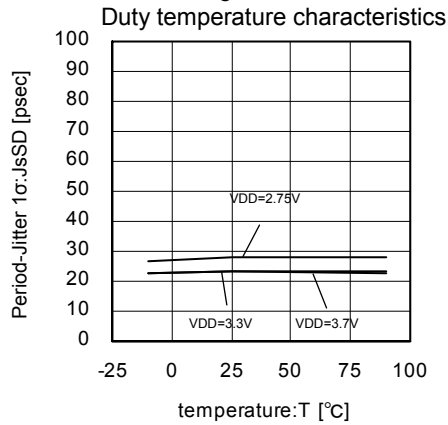

Fig.82 48MHz Period-Jitter 1σ temperature characteristics

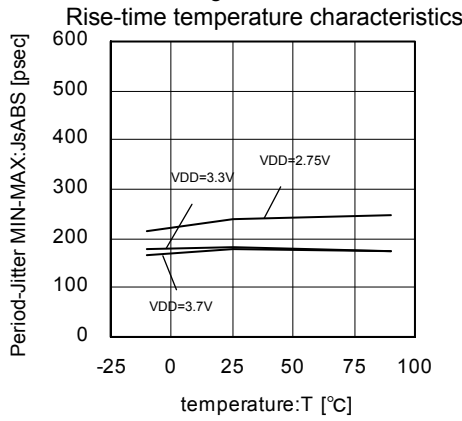

Fig.83 48MHz Jitter-Min Max temperature characteristics

Fall-time temperature characteristics

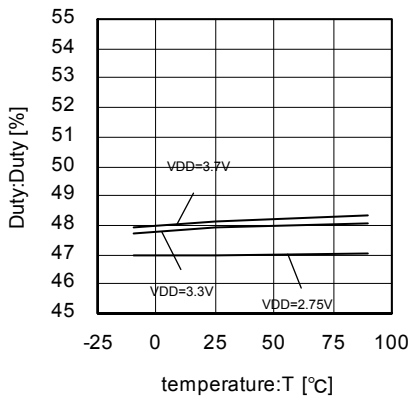

Fig.84 78MHz Duty temperature characteristics

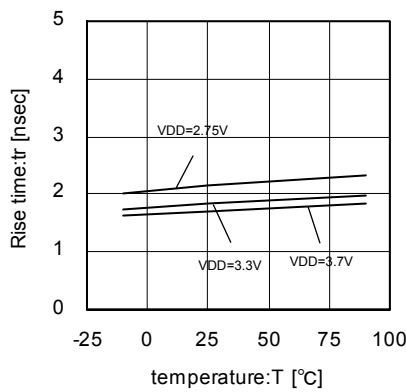

Fig.85 78MHz Rise-time temperature characteristics

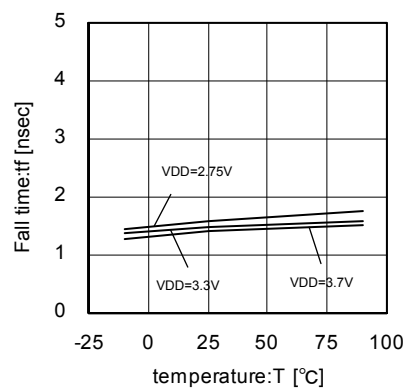

Fig.86 78MHz Fall-time temperature characteristics

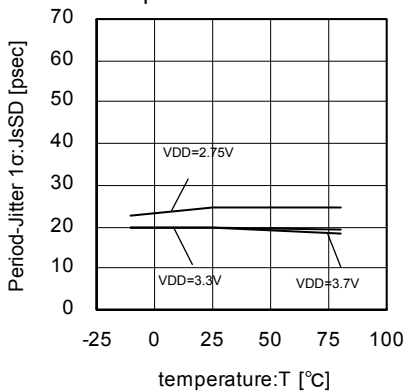

Fig.87 78MHz Period-Jitter 1σ temperature characteristics

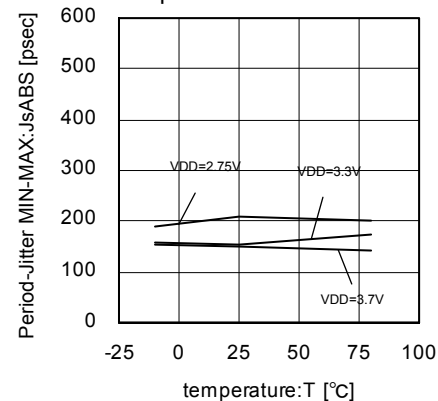

Fig.88 78MHz Jitter-MinMax temperature characteristic

●Block diagram, pin assignment/functions
(BU3071HFV)

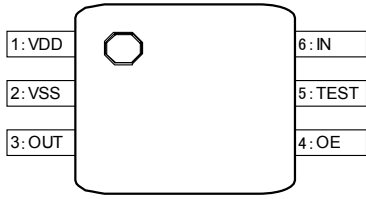

Fig.89

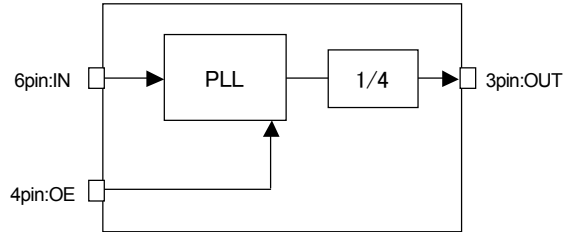

Fig.90

| PIN NO. | PIN name | Function |
|---------|----------|---|
| 1 | VDD | Power supply |
| 2 | VSS | GND |
| 3 | OUT | Clock output terminal |
| 4 | OE | Output enable (L: disable, H: enable), equipped with Pull-down function, output fixed to L at disable |
| 5 | TEST | TEST pin, equipped with Pull-down function |
| 6 | IN | Clock input pin (28.6363 MHz input) |

(BU3072HFV)

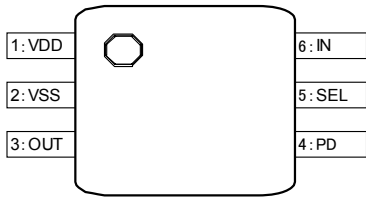

Fig.91

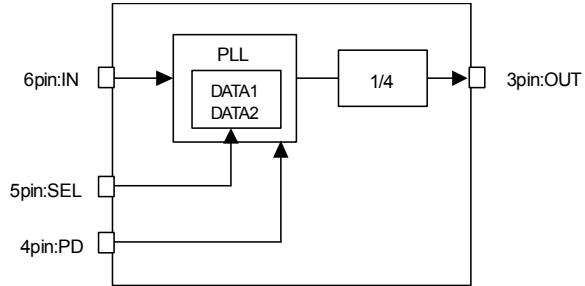

Fig.92

| PIN NO. | PIN name | Function |
|---------|----------|--|
| 1 | VDD | Power supply |
| 2 | VSS | GND |
| 3 | OUT | Clock output terminal (L:27.0000MHz, H:36.0000MHz) |
| 4 | PD | Power-down (L: Hi-Z, H: enable), equipped with Pull-down function, output set to Hi-Z at disable |
| 5 | SEL | Output selection (L: 27.0000 MHz, H: 36.0000 MHz) |
| 6 | IN | Clock input pin (48.0000 MHz input) |

(BU3073HFV)

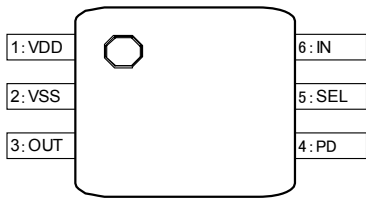

Fig.93

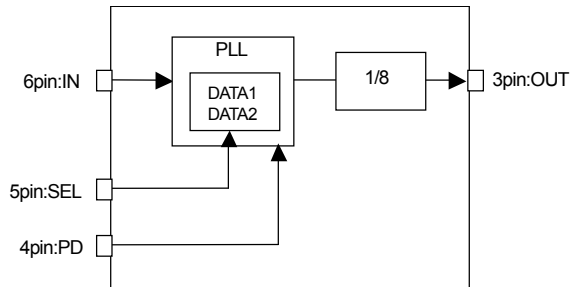

Fig.94

| PIN NO. | PIN name | Function |
|---------|----------|--|
| 1 | VDD | Power supply |
| 2 | VSS | GND |
| 3 | OUT | Clock output terminal (L:24.3750MHz, H:24.5454MHz) |
| 4 | PD | Power-down (L: disable, H: enable), equipped with Pull-down function, output set to L at disable |
| 5 | SEL | Output selection (L:24.3750MHz, H:24.5454MHz) |
| 6 | IN | Clock input pin (48.0000MHz input) |

(BU3076HFV)

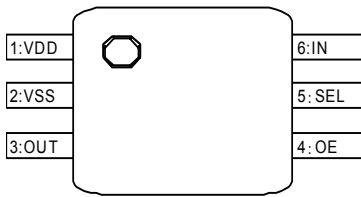

Fig.95

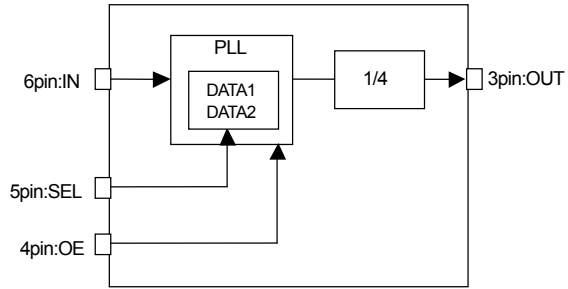

Fig.96

| PIN NO. | PIN name | Function |
|---------|----------|--|
| 1 | VDD | Power supply |
| 2 | VSS | GND |
| 3 | OUT | Clock output terminal (L:54.0000MHz, H:67.5000MHz) |
| 4 | OE | Power-down (L: disable, H: enable), equipped with Pull-down function, output set to L at disable |
| 5 | SEL | Output selection (L:54.0000MHz, H:67.5000MHz) |
| 6 | IN | Clock input pin (27.0000MHz input) |

(BU7322HFV)

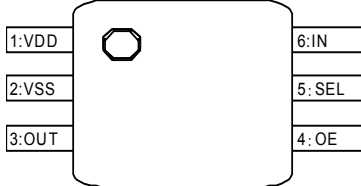

Fig.97

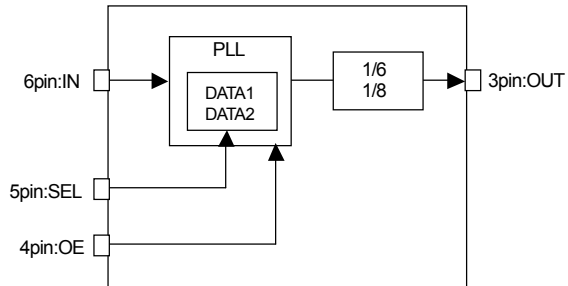

Fig.98

| PIN NO. | PIN name | Function |
|---------|----------|---|
| 1 | VDD | Power supply |
| 2 | VSS | GND |
| 3 | OUT | Clock output terminal (L:49.5000MHz, H:36.0000MHz) |
| 4 | OE | Power-down (L:disable ,H:enable) equipped with Pull-down function, disable output set to L at disable |
| 5 | SEL | Output selection (L:49.5000MHz, H:36.0000MHz) equipped with Pull-down function |
| 6 | IN | Clock input pin (27.0000MHz input) |

(BU7325HFV)

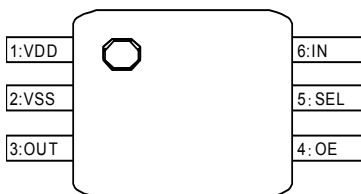

Fig.99

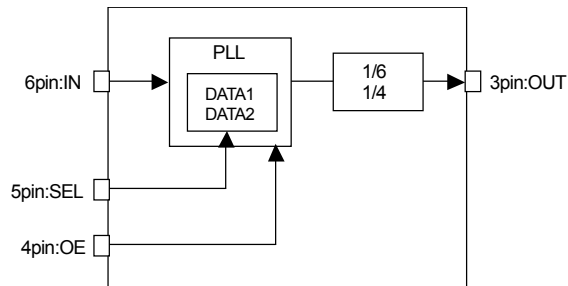

Fig.100

| PIN NO. | PIN name | Function |
|---------|----------|---|
| 1 | VDD | Power supply |
| 2 | VSS | GND |
| 3 | OUT | Clock output terminal (L:48.0000MHz, H:78.0000MHz) |
| 4 | OE | Power-down (L:disable ,H:enable) equipped with Pull-down function, disable output set to L at disable |
| 5 | SEL | Output selection (L:48.0000MHz, H:78.0000MHz) |
| 6 | IN | Clock input pin (27.0000MHz input) |

● Application circuit example

(BU3071HFV)

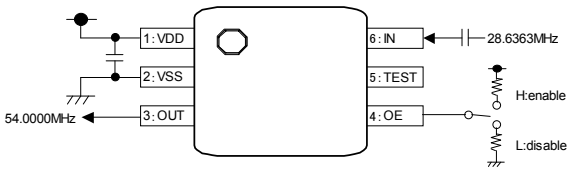

Fig.101

(BU3072HFV)

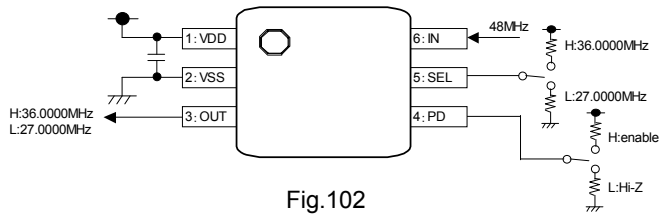

Fig.102

(BU3073HFV)

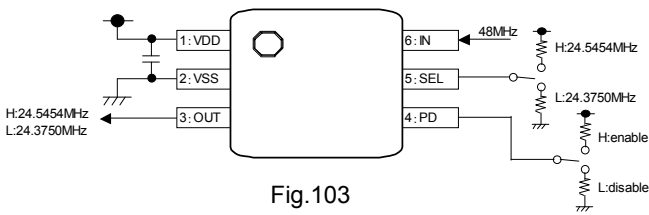

Fig.103

(BU3076HFV)

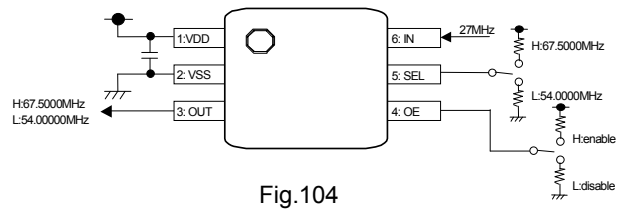

Fig.104

(BU7322HFV)

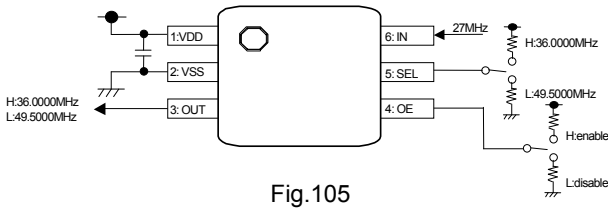

Fig.105

(BU7325HFV)

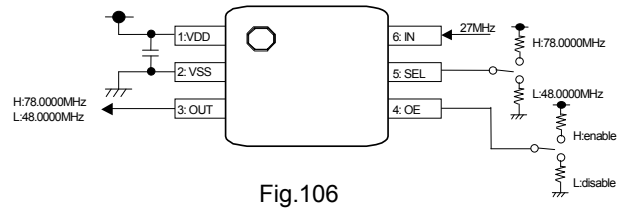

Fig.106

- * For VDD and VSS, insert a bypass capacitor of approx. 0.1 μF as close as possible to the pin.
- * Bypass capacitors with good high-frequency characteristics are recommended.
- * Even though we believe that the typical application circuit is worth of a recommendation, please be sure to thoroughly recheck the characteristics before use.

●Equivalent circuit

3-pin (Output pin)

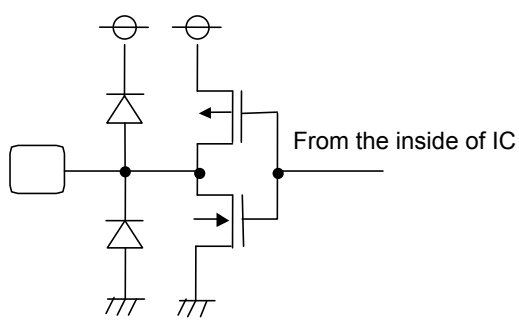

Fig.107

BU3071HFV, BU3073HFV, BU3076HFV
BU7322HFV, BU7325HFV

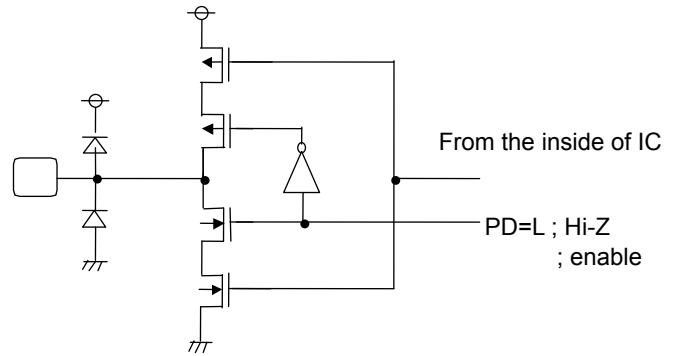

Fig.108

BU3072HFV

4-pin (Input pin)

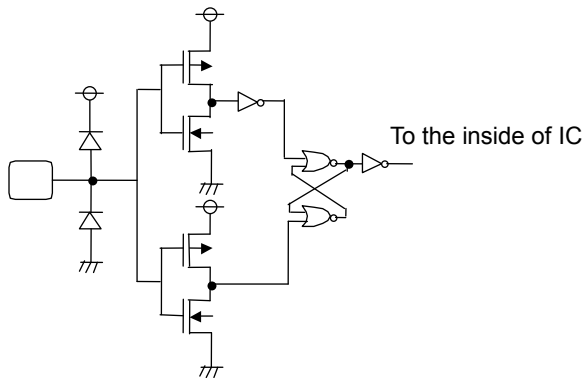

Fig.109

5-pin (Input pin)

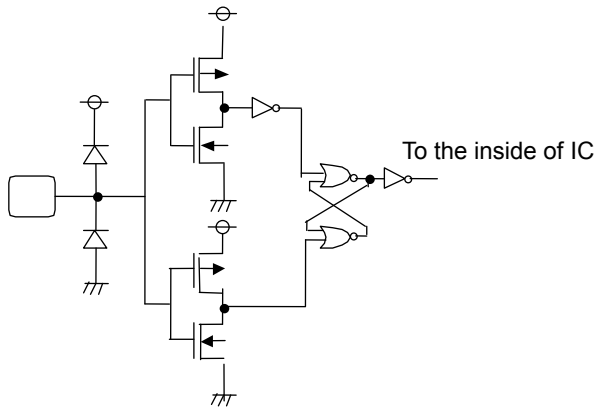

Fig.110
BU3072HFV, BU3073HFV, BU3076HFV
BU7322HFV, BU7325HFV

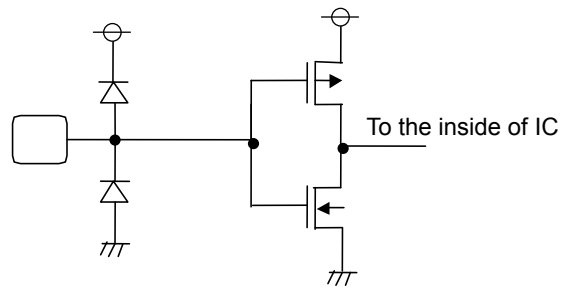

Fig.111
BU3071HFV

6-pin (Input pin)

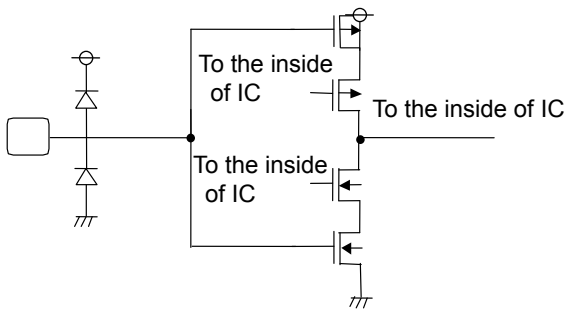

Fig.112
BU3072HFV, BU3073HFV, BU3076HFV
BU7322HFV, BU7325HFV

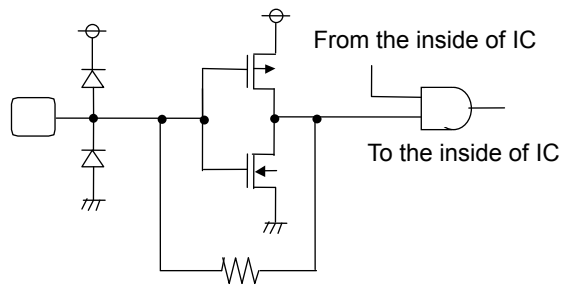

Fig.113
BU3071HFV

● Appearance of Marker

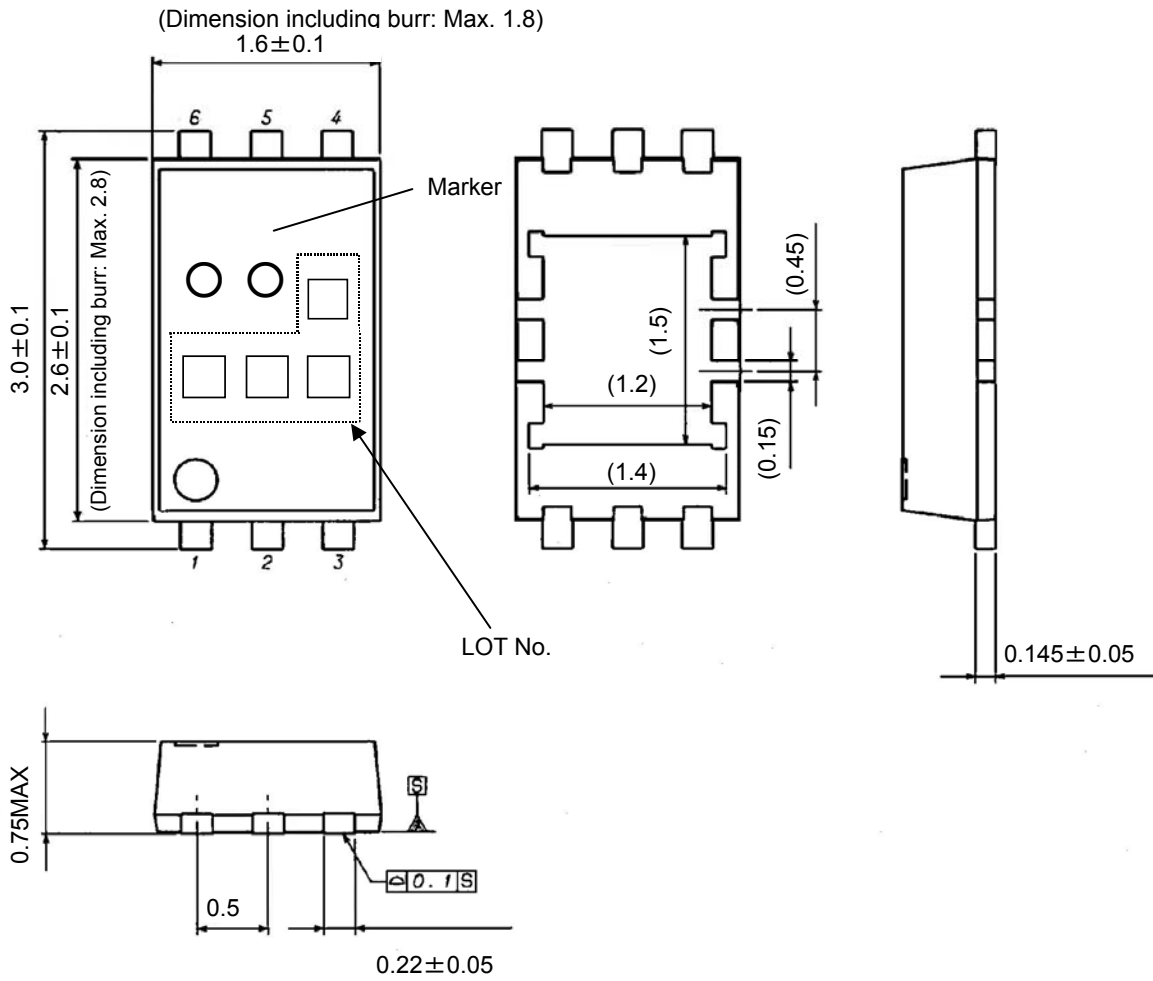

Fig.114

(UNIT : mm)

• List of markers

| Model name | Marker |
|------------|--------|
| BU3071HFV | AB |
| BU3072HFV | AC |
| BU3073HFV | AD |
| BU3076HFV | AA |
| BU7322HFV | AE |
| BU7325HFV | AH |

●Notes for use

- 1) Absolute Maximum Ratings
An excess in the absolute maximum ratings, such as applied voltage (VDD or VIN), operating temperature range (Topr), etc., can break down devices, thus making impossible to identify breaking mode such as a short circuit or an open circuit. If any special mode exceeding the absolute maximum ratings is assumed, consideration should be given to take physical safety measures including the use of fuses, etc.
- 2) Recommended operating conditions
These conditions represent a range within which characteristics can be provided approximately as expected. The electrical characteristics are guaranteed under the conditions of each parameter.
- 3) Reverse connection of power supply connector
The reverse connection of power supply connector can break down ICs. Take protective measures against the breakdown due to the reverse connection, such as mounting an external diode between the power supply and the IC's power supply terminal.
- 4) Power supply line
Design PCB pattern to provide low impedance for the wiring between the power supply and the GND lines.
In this regard, for the digital block power supply and the analog block power supply, even though these power supplies has the same level of potential, separate the power supply pattern for the digital block from that for the analog block, thus suppressing the diffraction of digital noises to the analog block power supply resulting from impedance common to the wiring patterns. For the GND line, give consideration to design the patterns in a similar manner.
Furthermore, for all power supply terminals to ICs, mount a capacitor between the power supply and the GND terminal. At the same time, in order to use an electrolytic capacitor, thoroughly check to be sure the characteristics of the capacitor to be used present no problem including the occurrence of capacity dropout at a low temperature, thus determining the constant.
- 5) GND voltage
Make setting of the potential of the GND terminal so that it will be maintained at the minimum in any operating state. Furthermore, check to be sure no terminals are at a potential lower than the GND voltage including an actual electric transient.
- 6) Short circuit between terminals and erroneous mounting
In order to mount ICs on a set PCB, pay thorough attention to the direction and offset of the ICs. Erroneous mounting can break down the ICs. Furthermore, if a short circuit occurs due to foreign matters entering between terminals or between the terminal and the power supply or the GND terminal, the ICs can break down.
- 7) Operation in strong electromagnetic field
Be noted that using ICs in the strong electromagnetic field can malfunction them.
- 8) Inspection with set PCB
On the inspection with the set PCB, if a capacitor is connected to a low-impedance IC terminal, the IC can suffer stress. Therefore, be sure to discharge from the set PCB by each process. Furthermore, in order to mount or dismount the set PCB to/from the jig for the inspection process, be sure to turn OFF the power supply and then mount the set PCB to the jig. After the completion of the inspection, be sure to turn OFF the power supply and then dismount it from the jig. In addition, for protection against static electricity, establish a ground for the assembly process and pay thorough attention to the transportation and the storage of the set PCB.
- 9) Input terminals
In terms of the construction of IC, parasitic elements are inevitably formed in relation to potential. The operation of the parasitic element can cause interference with circuit operation, thus resulting in a malfunction and then breakdown of the input terminal. Therefore, pay thorough attention not to handle the input terminals, such as to apply to the input terminals a voltage lower than the GND respectively, so that any parasitic element will operate. Furthermore, do not apply a voltage to the input terminals when no power supply voltage is applied to the IC. In addition, even if the power supply voltage is applied, apply to the input terminals a voltage lower than the power supply voltage or within the guaranteed value of electrical characteristics.
- 10) Ground wiring pattern
If small-signal GND and large-current GND are provided, It will be recommended to separate the large-current GND pattern from the small-signal GND pattern and establish a single ground at the reference point of the set PCB so that resistance to the wiring pattern and voltage fluctuations due to a large current will cause no fluctuations in voltages of the small-signal GND. Pay attention not to cause fluctuations in the GND wiring pattern of external parts as well.
- 11) External capacitor
In order to use a ceramic capacitor as the external capacitor, determine the constant with consideration given to a degradation in the nominal capacitance due to DC bias and changes in the capacitance due to temperature, etc.

● Ordering part number

| | |
|---|---|
| B | U |
|---|---|

Part No.

| | | | |
|---|---|---|---|
| 3 | 0 | 7 | 1 |
|---|---|---|---|

Part No.
3071, 3072, 3073
3076, 7322, 7325

| | | |
|---|---|---|
| H | F | V |
|---|---|---|

Package
HFV : HVSO6

| | |
|---|---|
| T | R |
|---|---|

Packaging and forming specification
TR: Embossed tape and reel

HVSO6

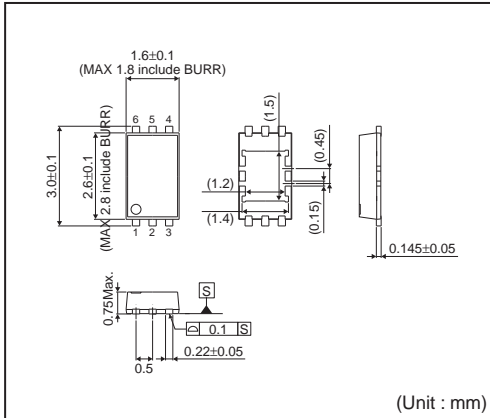

<Tape and Reel information>

| | |
|-------------------|---|
| Tape | Embossed carrier tape |
| Quantity | 3000pcs |
| Direction of feed | TR (The direction is the 1 pin of product is at the upper right when you hold reel on the left hand and you pull out the tape on the right hand) |

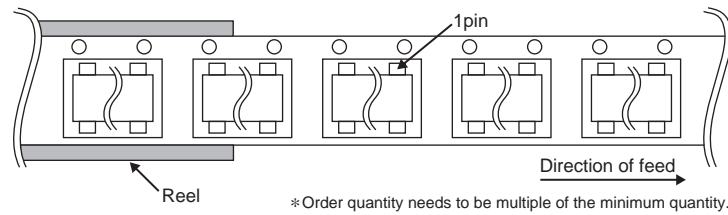

Notes

No copying or reproduction of this document, in part or in whole, is permitted without the consent of ROHM Co.,Ltd.

The content specified herein is subject to change for improvement without notice.

The content specified herein is for the purpose of introducing ROHM's products (hereinafter "Products"). If you wish to use any such Product, please be sure to refer to the specifications, which can be obtained from ROHM upon request.

Examples of application circuits, circuit constants and any other information contained herein illustrate the standard usage and operations of the Products. The peripheral conditions must be taken into account when designing circuits for mass production.

Great care was taken in ensuring the accuracy of the information specified in this document. However, should you incur any damage arising from any inaccuracy or misprint of such information, ROHM shall bear no responsibility for such damage.

The technical information specified herein is intended only to show the typical functions of and examples of application circuits for the Products. ROHM does not grant you, explicitly or implicitly, any license to use or exercise intellectual property or other rights held by ROHM and other parties. ROHM shall bear no responsibility whatsoever for any dispute arising from the use of such technical information.

The Products specified in this document are intended to be used with general-use electronic equipment or devices (such as audio visual equipment, office-automation equipment, communication devices, electronic appliances and amusement devices).

The Products specified in this document are not designed to be radiation tolerant.

While ROHM always makes efforts to enhance the quality and reliability of its Products, a Product may fail or malfunction for a variety of reasons.

Please be sure to implement in your equipment using the Products safety measures to guard against the possibility of physical injury, fire or any other damage caused in the event of the failure of any Product, such as derating, redundancy, fire control and fail-safe designs. ROHM shall bear no responsibility whatsoever for your use of any Product outside of the prescribed scope or not in accordance with the instruction manual.

The Products are not designed or manufactured to be used with any equipment, device or system which requires an extremely high level of reliability the failure or malfunction of which may result in a direct threat to human life or create a risk of human injury (such as a medical instrument, transportation equipment, aerospace machinery, nuclear-reactor controller, fuel-controller or other safety device). ROHM shall bear no responsibility in any way for use of any of the Products for the above special purposes. If a Product is intended to be used for any such special purpose, please contact a ROHM sales representative before purchasing.

If you intend to export or ship overseas any Product or technology specified herein that may be controlled under the Foreign Exchange and the Foreign Trade Law, you will be required to obtain a license or permit under the Law.



Thank you for your accessing to ROHM product informations.
More detail product informations and catalogs are available, please contact us.

ROHM Customer Support System

<http://www.rohm.com/contact/>



Looking for pricing, stock, or lifecycle information?

Click below to explore more details on WIN SOURCE:

-  [View BU7325HFV-TR on WIN SOURCE](#)
-  [Rohm Semiconductor](#) Information

Optimize Your Supply Chain with WIN SOURCE Solutions

-  Global Sourcing Solution
-  Obsolete Management
-  Cost Control Management
-  Shortage Management
-  Alternative Solution
-  Excess Inventory Management