

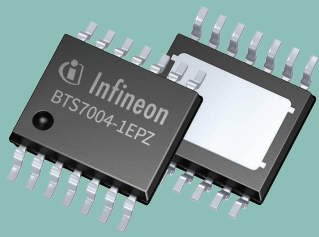

**THE DATASHEET OF
SHIELDBTS70802EPZTOB01**





Product brief

PROFET™+2 12V Grade0

High-side switch portfolio with extended junction temperature up to 175°C

PROFET™+2 12V is the new generation of smart high-side switches for automotive and industrial applications based on SMART7 technology. The family provides outstanding energy efficiency with reduced current consumption, state of the art current sense accuracy (KILIS), benchmark low cranking voltage capability and faster switching/slew rate with no impact on EMC. The whole portfolio is qualified for automotive applications according to AEC-Q100 Grade1 and AEC-Q100 Grade0.

PROFET™+2 12V Grade0 portfolio consists of six different high-side switches (from 4mΩ to 80 mΩ) and offers an extended junction temperature up to 175°C. State-of-the-art protection and diagnosis features, as well as the PG-TSDSO-14 exposed pad package are the same for PROFET™+2 12V Grade0 and Grade1 devices.

Key features

- > Operating voltage range 3.1–28 V with 3.3 V and 5 V compatible logic input
- > Protection: current tripping, over temperature, overvoltage, load dump, reverse polarity, short-circuit
- > Diagnosis: load current sense output

Key benefits

- > Extended thermal budget enables partitioning of higher ohmic parts at higher PCB temperature
- > Additional Grade0 qualification to fulfill requirements of extended mission profiles
- > Diagnosis concept tailored for power distribution
- > PROFET™+2 12V family approach

Key applications

Applications with extended or/and high temperature mission profiles:

- > Under the hood
- > Powertrain
- > Transmission

Block diagram

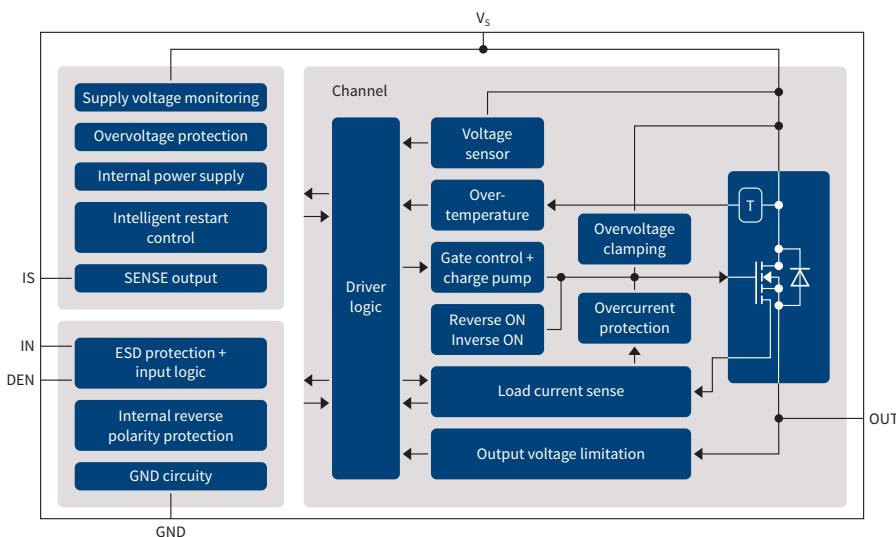

PROFET™+2 12V Grade0

High-side switch portfolio with extended junction temperature up to 175°C

Application diagram

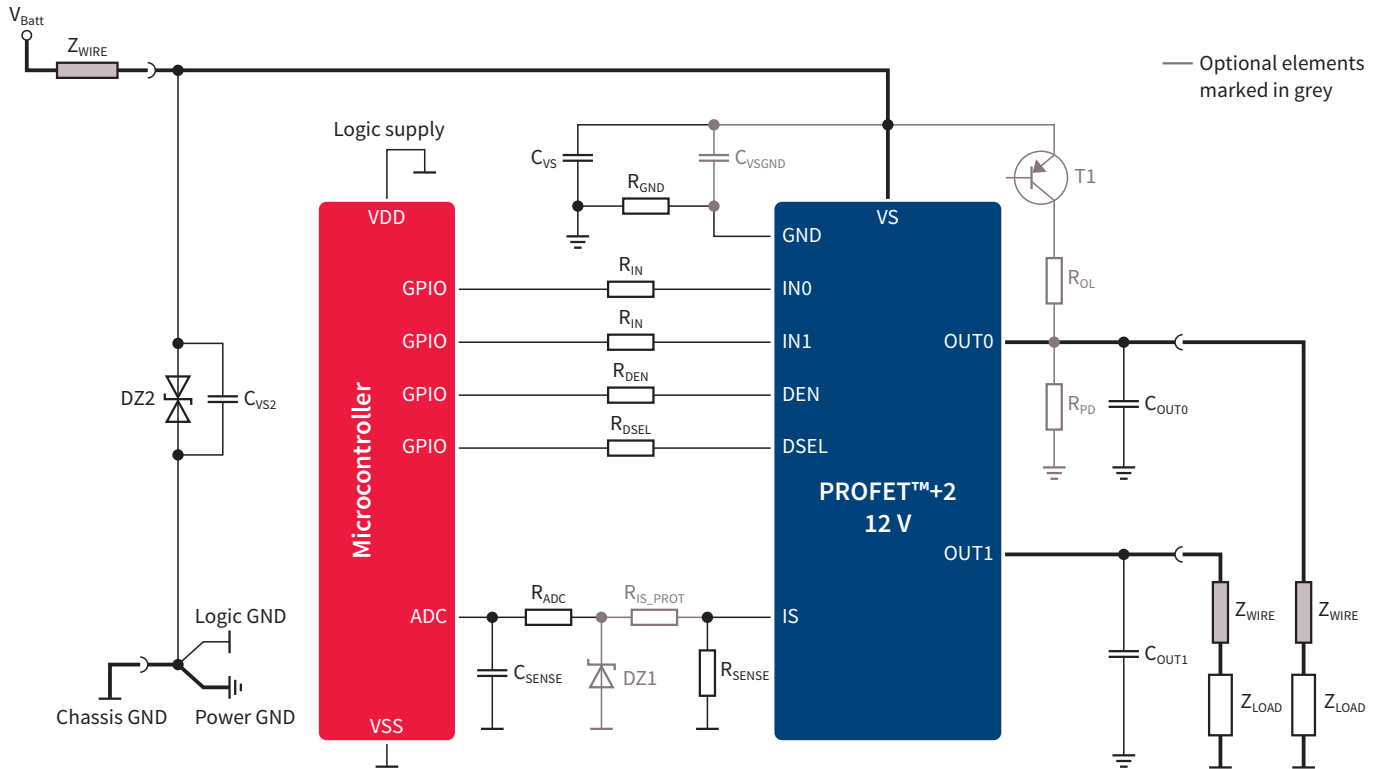

Product table

Product	$R_{DS(on)}$ (typ) [mΩ]	$R_{DS(on)}$ (max) @ $T_j = 150^\circ\text{C}$ [mΩ]	Nominal load current [A]	E_{AS} [mJ]	Operating voltage range [V]	IL short circuit current [mΩ]	Number of channels	Load current trip	Sense enable	Open load in OFF	Latch	Reverse ON	Package name
NEW BTS7004-1EPZ	4.4	8.0	15.0	150	3.1 ... 28.0	107.0	1	●	●	●	●	●	TSDSO-14
NEW BTS7006-1EPZ	6.6	12.0	12.5	95	3.1 ... 28.0	89.5	1	●	●	●	●	●	TSDSO-14
NEW BTS7008-1EPZ	9.0	16.0	10.0	65	3.1 ... 28.0	88.0	1	●	●	●	●	●	TSDSO-14
NEW BTS7008-2EPZ	9.0	16.0	7.5	75	3.1 ... 28.0	88.0	2	●	●	●	●	●	TSDSO-14
NEW BTS7040-1EPZ	19.0	36.0	4.5	30	3.1 ... 28.0	46.0	1	●	●	●	●	●	TSDSO-14
NEW BTS7080-2EPZ	20.9	39.6	3.0	36	3.1 ... 28.0	36.0	2	●	●	●	●	●	TSDSO-14

Published by
Infineon Technologies AG
81726 Munich, Germany

© 2020 Infineon Technologies AG.
All Rights Reserved.

Please note!

This Document is for information purposes only and any information given herein shall in no event be regarded as a warranty, guarantee or description of any functionality, conditions and/or quality of our products or any suitability for a particular purpose. With regard to the technical specifications of our products, we kindly ask you to refer to the relevant product data sheets provided by us. Our customers and their technical departments are required to evaluate the suitability of our products for the intended application.

We reserve the right to change this document and/or the information given herein at any time.

Additional information

For further information on technologies, our products, the application of our products, delivery terms and conditions and/or prices, please contact your nearest Infineon Technologies office (www.infineon.com).



Warnings

Due to technical requirements, our products may contain dangerous substances. For information on the types in question, please contact your nearest Infineon Technologies office.

Except as otherwise explicitly approved by us in a written document signed by authorized representatives of Infineon Technologies, our products may not be used in any life-endangering applications, including but not limited to medical, nuclear, military, life-critical or any other applications where a failure of the product or any consequences of the use thereof can result in personal injury.

Looking for pricing, stock, or lifecycle information?

Click below to explore more details on WIN SOURCE:

-  [View SHIELDBTS70802EPZTOBO1 on WIN SOURCE](#)
-  [Infineon Technologies Information](#)

Optimize Your Supply Chain with WIN SOURCE Solutions

-  Global Sourcing Solution
-  Obsolete Management
-  Cost Control Management
-  Shortage Management
-  Alternative Solution
-  Excess Inventory Management