



**THE DATASHEET OF  
TL1100GF160Q**



# SERIES TL 1100 SWITCHES

TACT SWITCHES - 12mm x 12mm

TACT SWITCHES

NAVIGATION SWITCHES

PUSHBUTTON SWITCHES

TOGGLE SWITCHES

ROCKER SWITCHES

SLIDE SWITCHES

SNAP-ACTION SWITCHES

DIP SWITCHES

KEYLOCK SWITCHES

ROTARY SWITCHES

DETECTOR SWITCHES

CAP OPTIONS



## SPECIFICATIONS

Contact Rating:	50mA @ 12 VDC
Life Expectancy:	100,000 cycles
Contact Resistance:	100mΩ max., typical @ 2-4 VDC 100mA for both silver and gold plated contacts
Insulation Resistance:	100MΩ min.
Dielectric Strength:	250VAC
Actuation Force:	160± 50 gf, 260± 50 gf
Operating Temperature:	-20°C to 70°C
Travel:	0.3 Typ.

## MATERIALS

Housing:	Polyester
Actuator:	Polyester
Cover:	Polyester
Contacts:	Silver plated phosphor bronze
Terminals:	Silver plated copper alloy

### FEATURES & BENEFITS

- ▶ Reliable dome contact technology
- ▶ Strong tactile/audible feedback
- ▶ Multiple operating force options

### APPLICATIONS/MARKETS

- ▶ Telecommunications
- ▶ Consumer Electronics
- ▶ Audio/visual
- ▶ Medical
- ▶ Testing/instrumentation
- ▶ Computer/servers/peripherals

## HOW TO ORDER

SERIES	MODEL NO.	ACTUATOR ("L" Dimension)	OPERATING FORCE	CONTACT MATERIAL	CAP (Where Avail.)	CAP COLOR
TL	1100	(None)* = 3.3mm □ A = 3.8mm □ D = 4.3mm E = 7.5mm F = 12mm	F160 F260	Q = Silver R = Gold	See Cap Options *Caps available for these options only	
		Right Angle Options C* = 6.45mm □ G = 11.2mm				

**Example Ordering Number**  
TL-1100-C-F260-Q-TAK-GRY

□ - Square Snap-on Actuator Head  
"L" Dimension is 7.5mm

Specifications subject to change without notice. 6.9.22

## TL 1100

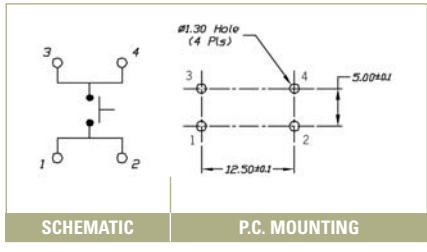
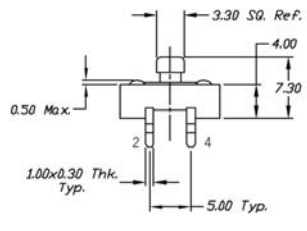
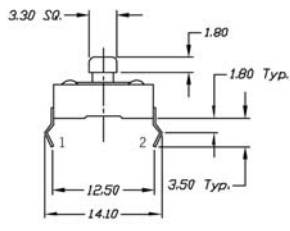



### TL 1100 A

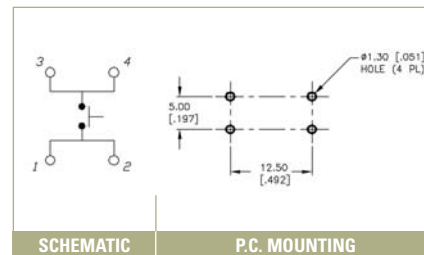
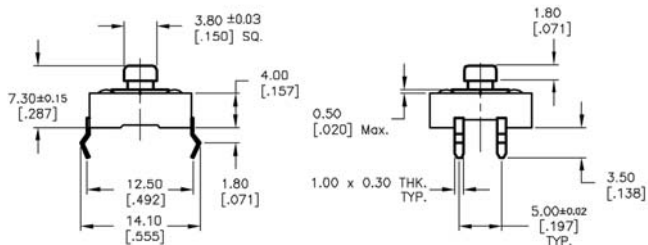

SCHEMATIC

P.C. MOUNTING

### TL 1100 C

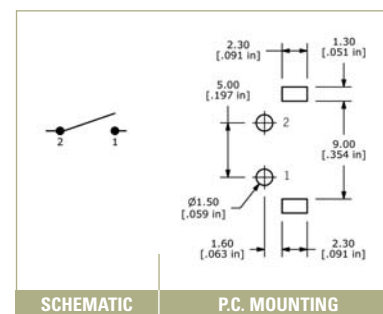
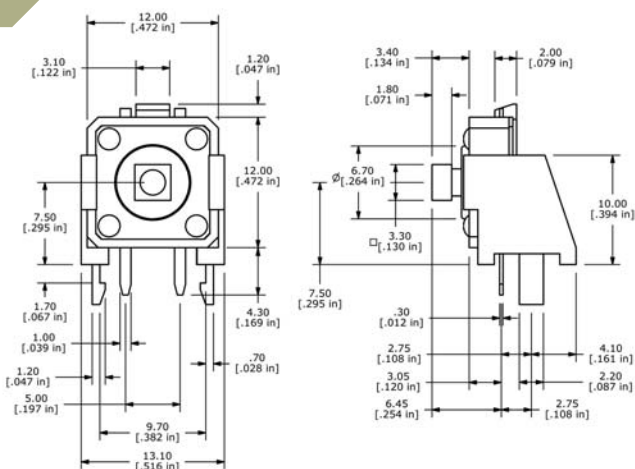

SCHEMATIC

P.C. MOUNTING

### TL 1100 D

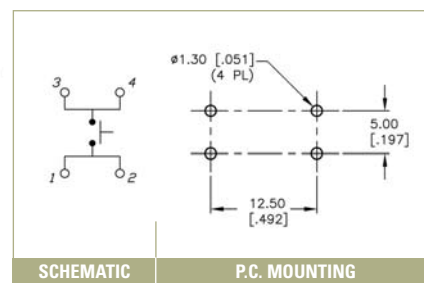
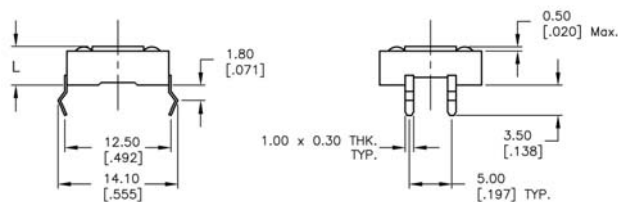

SCHEMATIC

P.C. MOUNTING

Actuator Length (L) in mm

D = 4.3mm

### TL 1100 E

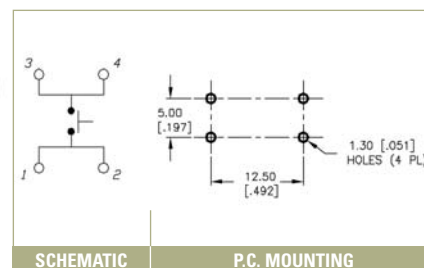
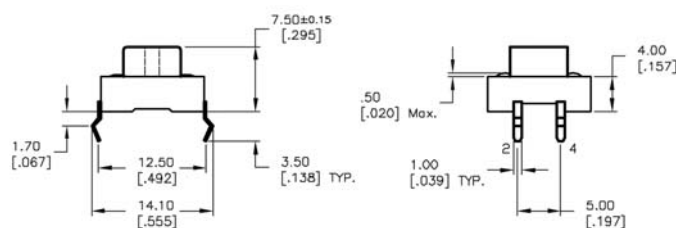

SCHEMATIC

P.C. MOUNTING



# SERIES TL1100 SWITCHES

## TACT SWITCHES - 12mm x 12mm

TACT SWITCHES

NAVIGATION SWITCHES

PUSHBUTTON SWITCHES

TOGGLE SWITCHES

ROCKER SWITCHES

SLIDE SWITCHES

SNAP-ACTION SWITCHES

DIP SWITCHES

KEYLOCK SWITCHES

ROTARY SWITCHES

DETECTOR SWITCHES

CAP OPTIONS

### TL 1100 F

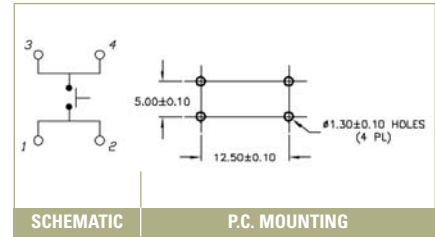
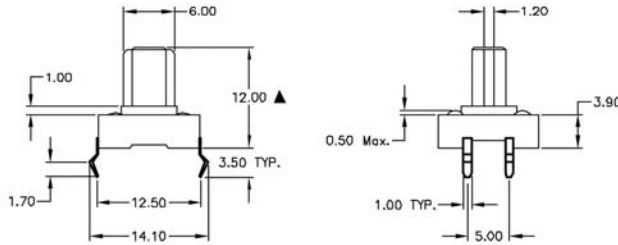

### TL 1100 G

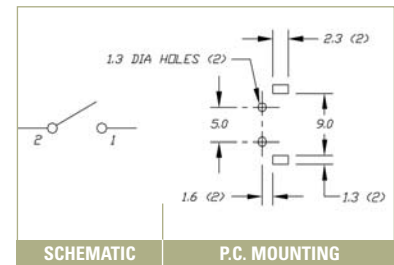
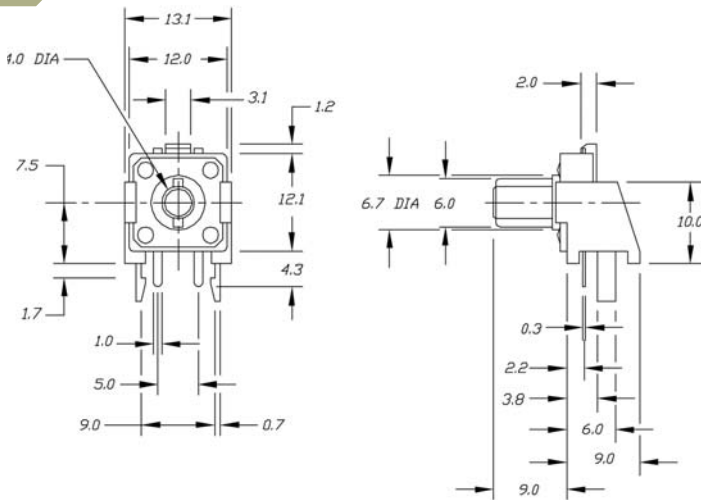





## Looking for pricing, stock, or lifecycle information?

Click below to explore more details on WIN SOURCE:

 [View TL1100GF160Q on WIN SOURCE](#)

 [E-Switch Information](#)

## Optimize Your Supply Chain with WIN SOURCE Solutions

-  Global Sourcing Solution
-  Obsolete Management
-  Cost Control Management
-  Shortage Management
-  Alternative Solution
-  Excess Inventory Management