



**THE DATASHEET OF
ZXMS6005SGQTA**



Product Summary

- Continuous Drain Source Voltage $V_{DS} = 60V$
- On-State Resistance 200m Ω
- Nominal Load Current ($V_{IN} = 5V$) 2A
- Clamping Energy 480mJ

Description

The ZXMS6005SGQ is a self protected low side IntelliFET™ MOSFET with logic level input. It integrates over-temperature; over-current, over-voltage (active clamp) and ESD protected logic level functionality. The ZXMS6005SGQ is ideal as a general purpose switch driven from 3.3V or 5V microcontrollers in harsh environments where standard MOSFETs are not rugged enough.

Applications

- Especially Suited for Loads with a High In-rush Current such as Lamps and Motors
- All Types of Resistive, Inductive and Capacitive Loads in Switching Applications
- μC Compatible Power Switch for 12V DC Applications
- Automotive Rated
- Replaces Electromechanical Relays and Discrete Circuits
- Linear Mode capability - the current-limiting protection circuitry is designed to de-activate at low V_{DS} to minimize on state power dissipation. The maximum DC operating current is therefore determined by the thermal capability of the package/board combination, rather than by the protection circuitry. This does not compromise the product's ability to self-protect at low V_{DS} .

Features and Benefits

- Compact High Power Dissipation Package
- Low Input Current
- Logic Level Input (3.3V and 5V)
- Short Circuit Protection with Auto Restart
- Over Voltage Protection (Active Clamp)
- Thermal Shutdown with Auto Restart
- Over-Current Protection
- Input Protection (ESD)
- High Continuous Current Rating
- **Lead-Free Finish; RoHS Compliant (Notes 1 & 2)**
- **Halogen and Antimony Free. "Green" Device (Note 3)**
- **The ZXMS6005SGQ is suitable for automotive applications requiring specific change control; this part is AEC-Q101 qualified, PPAP capable, and manufactured in IATF 16949 certified facilities.**
<https://www.diodes.com/quality/product-definitions/>

Mechanical Data

- Case: SOT223
- Case Material: Molded Plastic, "Green" Molding Compound. UL Flammability Classification Rating 94V-0
- Moisture Sensitivity: Level 1 per J-STD-020
- Terminals: Matte Tin Finish (Ⓔ3)
- Weight: 0.112 grams (Approximate)

SOT223 (Type DN)

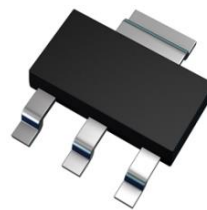

Top View

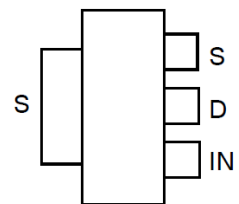

Top View
Pin Out

Ordering Information (Note 4)

Part Number	Marking	Reel Size (inches)	Tape Width (mm)	Quantity Per Reel
ZXMS6005SGQTA	ZXMS6005S	7	12	1,000 Units
ZXMS6005SGQ-13	ZXMS6005S	13	12	2,500 Units

- Notes:
1. EU Directive 2002/95/EC (RoHS), 2011/65/EU (RoHS 2) & 2015/863/EU (RoHS 3) compliant. All applicable RoHS exemptions applied.
 2. See <https://www.diodes.com/quality/lead-free/> for more information about Diodes Incorporated's definitions of Halogen- and Antimony-free, "Green" and Lead-free.
 3. Halogen- and Antimony-free "Green" products are defined as those which contain <900ppm bromine, <900ppm chlorine (<1500ppm total Br + Cl) and <1000ppm antimony compounds.
 4. For packaging details, go to our website at <https://www.diodes.com/design/support/packaging/diodes-packaging/>.

Marking Information

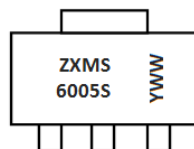

ZXMS6005S = Product Type Marking Code
 YWW = Date Code Marking
 Y or \bar{Y} = Last Digit of Year (ex: 0 = 2020)
 WW or $\bar{W}W$ = Week Code (01 to 53)

Functional Block Diagram

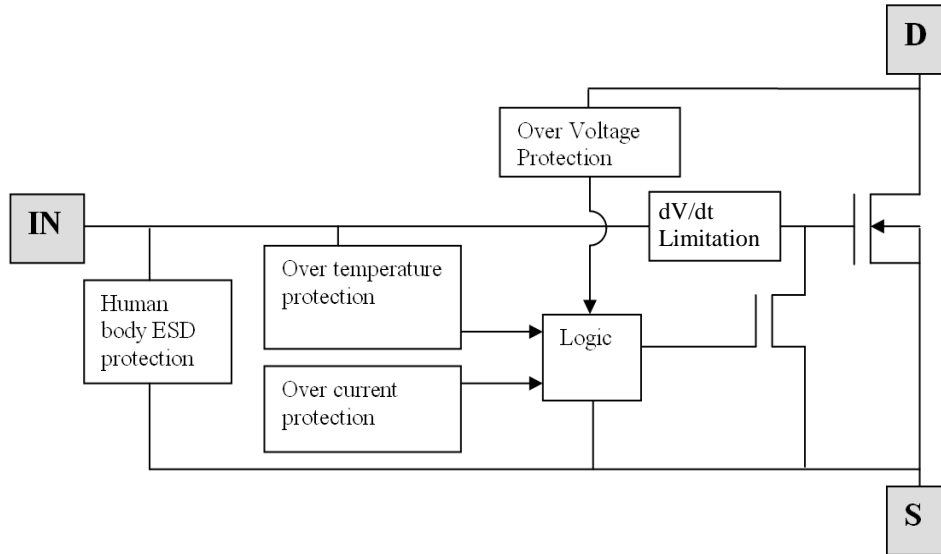

Absolute Maximum Ratings (@T_A = +25°C, unless otherwise stated.)

Characteristic	Symbol	Value	Unit
Continuous Drain-Source Voltage	V _{DS}	60	V
Drain-Source Voltage for Short Circuit Protection	V _{DS(SC)}	24	V
Continuous Input Voltage	V _{IN}	-0.5 to +6	V
Continuous Input Current @ -0.2V ≤ V _{IN} ≤ 6V	I _{IN}	No limit	mA
Continuous Input Current @ V _{IN} < -0.2V or V _{IN} > 6V	I _{IN}	I _{IN} ≤ 2	mA
Pulsed Drain Current @ V _{IN} = 3.3V	I _{DM}	5	A
Pulsed Drain Current @ V _{IN} = 5V	I _{DM}	6	A
Continuous Source Current (Body Diode) (Note 5)	I _S	2.5	A
Pulsed Source Current (Body Diode)	I _{SM}	10	A
Unclamped Single Pulse Inductive Energy, T _J = +25°C, I _D = 0.5A, V _{DD} = 24V	E _{AS}	480	mJ
Electrostatic Discharge (Human Body Model)	V _{ESD}	4000	V
Charged Device Model	V _{CDM}	1000	V

Thermal Characteristics (@T_A = +25°C, unless otherwise stated.)

Characteristic	Symbol	Value	Unit
Power Dissipation at T _A = +25°C (Note 5)	P _D	1.0	W
Linear Derating Factor		8.0	mW/°C
Power Dissipation at T _A = +25°C (Note 6)	P _D	1.6	W
Linear Derating Factor		12.8	mW/°C
Thermal Resistance, Junction to Ambient (Note 5)	R _{θJA}	125	°C/W
Thermal Resistance, Junction to Ambient (Note 6)	R _{θJA}	83	°C/W
Thermal Resistance, Junction to Case (Note 7)	R _{θJC}	39	°C/W
Operating Temperature Range	T _J	-40 to +150	°C
Storage Temperature Range	T _{STG}	-55 to +150	°C

- Notes:
5. For a device surface mounted on 15mm x 15mm single sided 1oz weight copper on 1.6mm FR-4 board, in still air conditions. Sink split drain 80% and source 20% to isolate connections.
 6. For a device surface mounted on 50mm x 50mm single sided 2oz weight copper on 1.6mm FR-4 board, in still air conditions. Sink split drain 80% and source 20% to isolate connections.
 7. Thermal resistance between junction and the mounting surfaces of drain and source pins.

Recommended Operating Conditions

The ZXMS6005SGQ is optimized for use with μ C operating from 3.3V and 5V supplies.

Characteristic	Symbol	Min	Max	Unit
Input Voltage Range	V_{IN}	0	5.5	V
Ambient Temperature Range	T_A	-40	+125	$^{\circ}$ C
High Level Input Voltage for MOSFET to Be On	V_{IH}	3	5.5	V
Low Level Input Voltage for MOSFET to Be Off	V_{IL}	0	0.7	V
Peripheral Supply Voltage (Voltage to Which Load Is Referred)	V_P	0	24	V

Thermal Characteristics

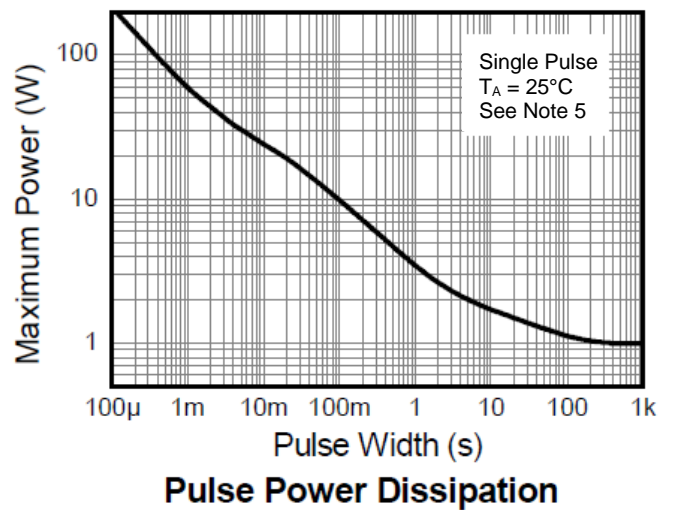
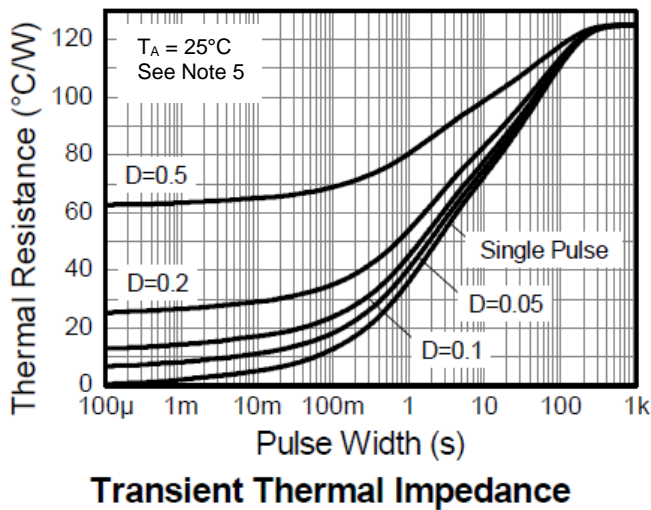
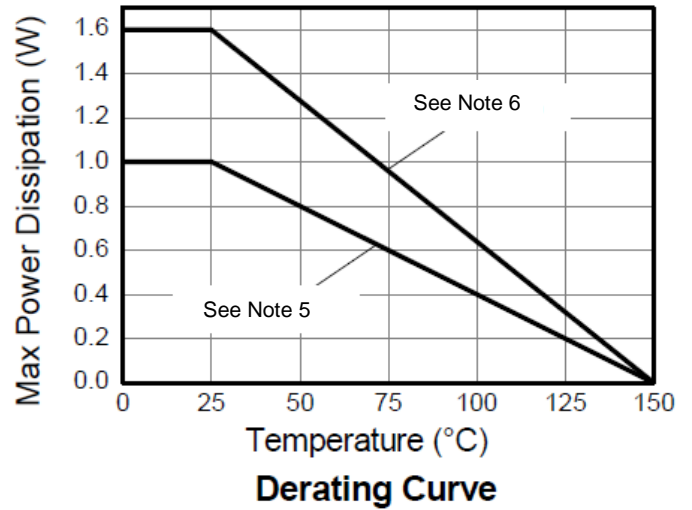
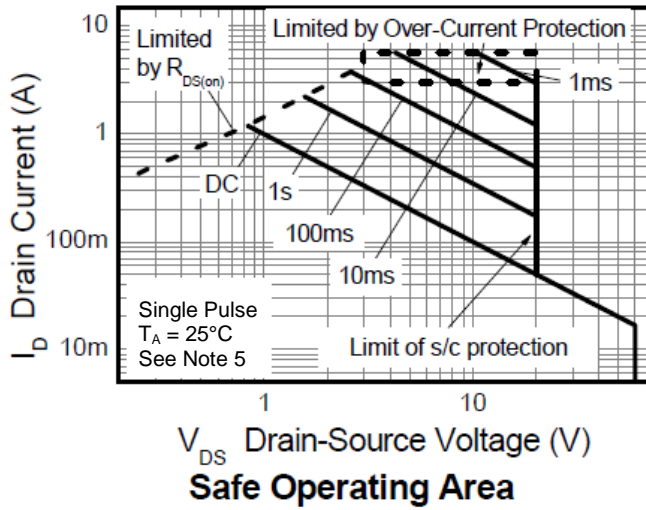

Electrical Characteristics (@T_A = +25°C, unless otherwise stated.)

Characteristic	Symbol	Min	Typ	Max	Unit	Test Condition
Static Characteristics						
Drain-Source Clamp Voltage	V _{DS(AZ)}	60	65	70	V	I _D = 10mA
Off State Drain Current	I _{DSS}	—	—	1	μA	V _{DS} = 12V, V _{IN} = 0V
		—	—	2		V _{DS} = 36V, V _{IN} = 0V
Input Threshold Voltage	V _{IN(TH)}	0.7	1.2	1.5	V	V _{DS} = V _{GS} , I _D = 1mA
Input Current	I _{IN}	—	60	100	μA	V _{IN} = 3V
		—	120	200		V _{IN} = 5V
Input Current While Over Temperature Active	—	—	—	300	μA	V _{IN} = 5V
Static Drain-Source On-State Resistance	R _{DS(ON)}	—	170	250	mΩ	V _{IN} = 3V, I _D = 1A
		—	150	200		V _{IN} = 5V, I _D = 1A
Continuous Drain Current (Note 5)	I _D	1.4	—	—	A	V _{IN} = 3V, T _A = +25°C
		1.6	—	—		V _{IN} = 5V, T _A = +25°C
Continuous Drain Current (Note 6)		1.9	—	—		V _{IN} = 3V, T _A = +25°C
		2.0	—	—		V _{IN} = 5V, T _A = +25°C
Current Limit (Note 8)	I _{D(LIM)}	2.2	5	—	A	V _{IN} = 3V
		3.3	7	—		V _{IN} = 5V
Dynamic Characteristics						
Turn On Delay Time	t _{D(ON)}	—	6	—	μs	V _{DD} = 12V, I _D = 1A, V _{GS} = 5V
Rise Time	t _R	—	14	—		
Turn Off Delay Time	t _{D(OFF)}	—	34	—		
Fall Time	t _F	—	19	—		
Over-Temperature Protection						
Thermal Overload Trip Temperature (Note 9)	T _{JT}	+150	+175	—	°C	—
Thermal Hysteresis (Note 9)	—	—	+10	—	°C	—

- Notes:
5. For a device surface mounted on 15mm x 15mm single sided 1oz weight copper on 1.6mm FR-4 board, in still air conditions. Sink split drain 80% and source 20% to isolate connections.
 6. For a device surface mounted on 50mm x 50mm single sided 2oz weight copper on 1.6mm FR-4 board, in still air conditions. Sink split drain 80% and source 20% to isolate connections.
 7. Thermal resistance between junction and the mounting surfaces of drain and source pins.
 8. The drain current is restricted only when the device is in saturation (see graph 'Typical Output Characteristic'). This allows the device to be used in the fully on state without interference from the current limit. The device is fully protected at all drain currents, as the low power dissipation generated outside saturation makes current limit unnecessary.
 9. Over-temperature protection is designed to prevent device destruction under fault conditions. Fault conditions are considered as "outside" normal operating range, so this part is not designed to withstand over-temperature for extended periods.

Typical Characteristics

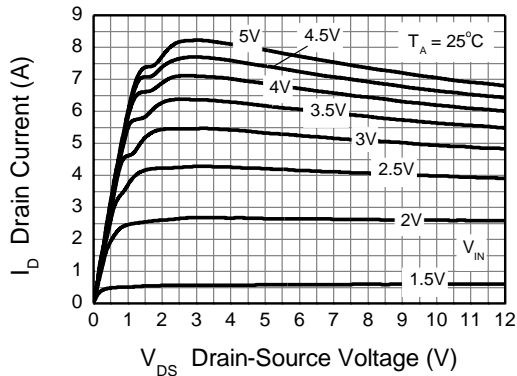

Typical Output Characteristic

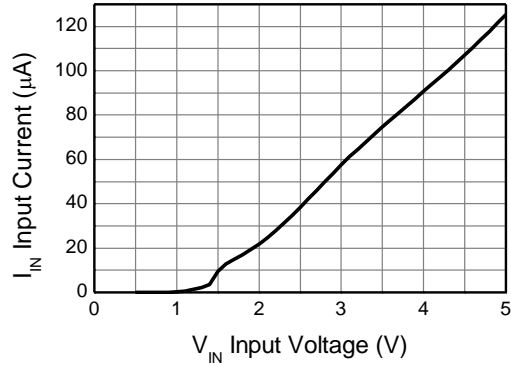

Input Current vs Input Voltage

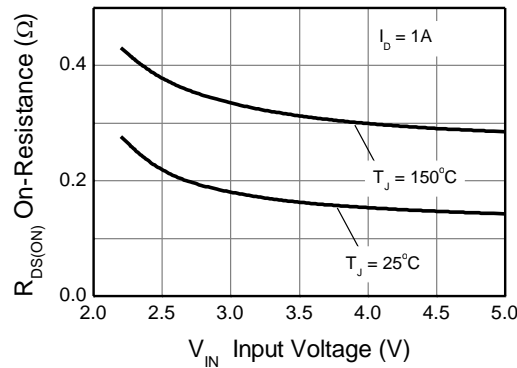

On-Resistance vs Input Voltage

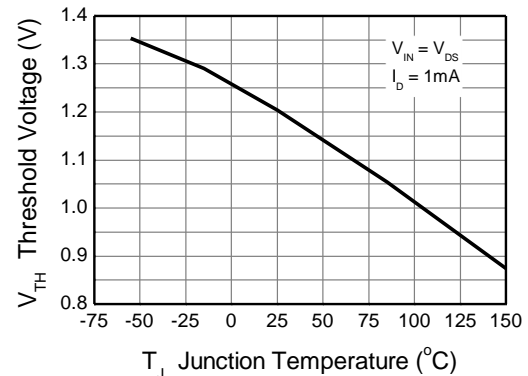

Threshold Voltage vs Temperature

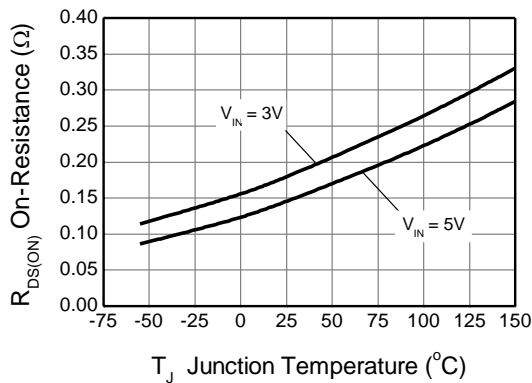

On-Resistance vs Temperature

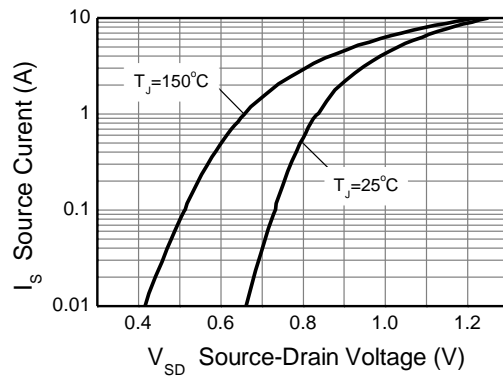

Reverse Diode Characteristic

Typical Characteristics (continued)

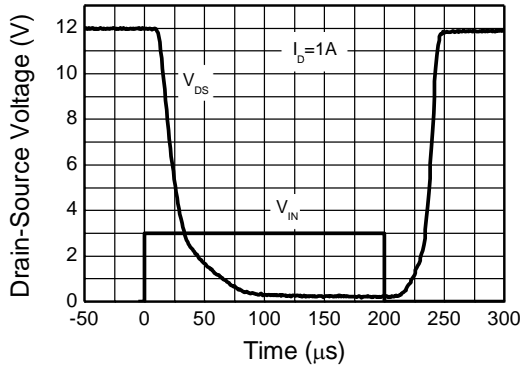

Switching Speed

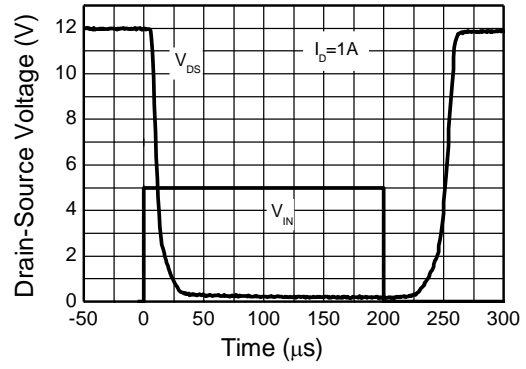

Switching Speed

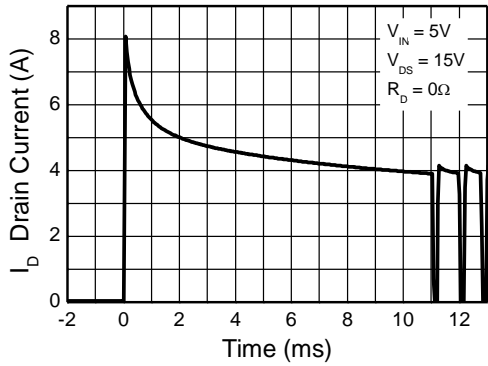

Typical Short Circuit Protection

Package Outline Dimensions

Please see <http://www.diodes.com/package-outlines.html> for the latest version.

SOT223 (Type DN)

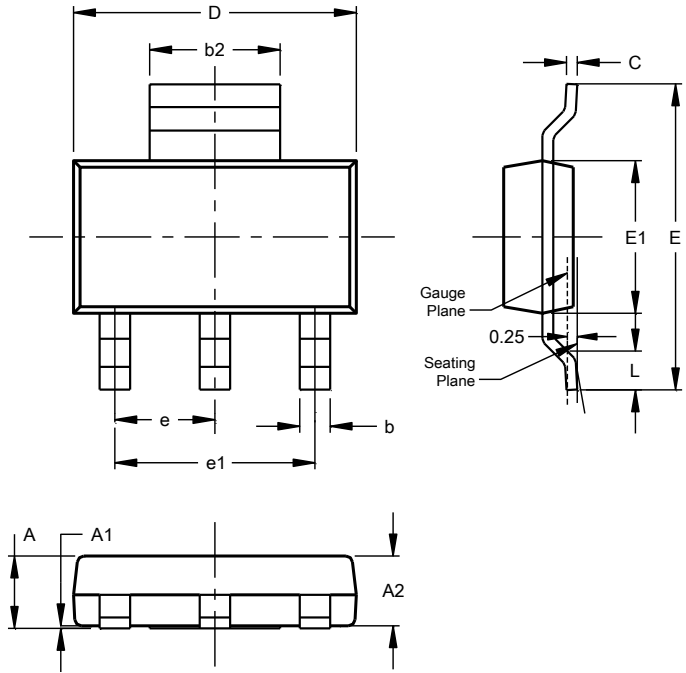

SOT223 (Type DN)			
Dim	Min	Max	Typ
A	--	1.70	--
A1	0.01	0.15	--
A2	1.50	1.68	1.60
b	0.60	0.80	0.70
b2	2.90	3.10	--
c	0.20	0.32	--
D	6.30	6.70	--
E	6.70	7.30	--
E1	3.30	3.70	--
e	--	--	2.30
e1	--	--	4.60
L	0.85	--	--
All Dimensions in mm			

Suggested Pad Layout

Please see <http://www.diodes.com/package-outlines.html> for the latest version.

SOT223 (Type DN)

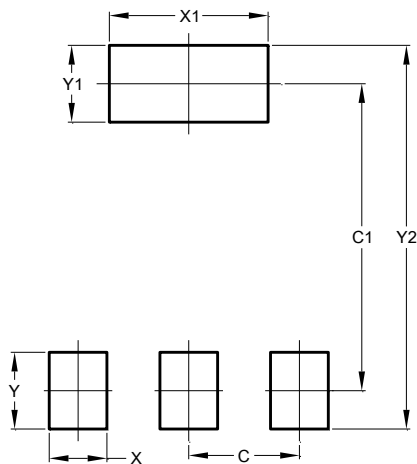

Dimensions	Value (in mm)
C	2.30
C1	6.40
X	1.20
X1	3.30
Y	1.60
Y1	1.60
Y2	8.00

IMPORTANT NOTICE

1. DIODES INCORPORATED AND ITS SUBSIDIARIES (“DIODES”) MAKE NO WARRANTY OF ANY KIND, EXPRESS OR IMPLIED, WITH REGARDS TO ANY INFORMATION CONTAINED IN THIS DOCUMENT, INCLUDING, BUT NOT LIMITED TO, THE IMPLIED WARRANTIES OF MERCHANTABILITY, FITNESS FOR A PARTICULAR PURPOSE OR NON-INFRINGEMENT OF THIRD PARTY INTELLECTUAL PROPERTY RIGHTS (AND THEIR EQUIVALENTS UNDER THE LAWS OF ANY JURISDICTION).
2. The Information contained herein is for informational purpose only and is provided only to illustrate the operation of Diodes products described herein and application examples. Diodes does not assume any liability arising out of the application or use of this document or any product described herein. This document is intended for skilled and technically trained engineering customers and users who design with Diodes products. Diodes products may be used to facilitate safety-related applications; however, in all instances customers and users are responsible for (a) selecting the appropriate Diodes products for their applications, (b) evaluating the suitability of the Diodes products for their intended applications, (c) ensuring their applications, which incorporate Diodes products, comply the applicable legal and regulatory requirements as well as safety and functional-safety related standards, and (d) ensuring they design with appropriate safeguards (including testing, validation, quality control techniques, redundancy, malfunction prevention, and appropriate treatment for aging degradation) to minimize the risks associated with their applications.
3. Diodes assumes no liability for any application-related information, support, assistance or feedback that may be provided by Diodes from time to time. Any customer or user of this document or products described herein will assume all risks and liabilities associated with such use, and will hold Diodes and all companies whose products are represented herein or on Diodes’ websites, harmless against all damages and liabilities.
4. Products described herein may be covered by one or more United States, international or foreign patents and pending patent applications. Product names and markings noted herein may also be covered by one or more United States, international or foreign trademarks and trademark applications. Diodes does not convey any license under any of its intellectual property rights or the rights of any third parties (including third parties whose products and services may be described in this document or on Diodes’ website) under this document.
5. Diodes products are provided subject to Diodes’ Standard Terms and Conditions of Sale (<https://www.diodes.com/about/company/terms-and-conditions/terms-and-conditions-of-sales/>) or other applicable terms. This document does not alter or expand the applicable warranties provided by Diodes. Diodes does not warrant or accept any liability whatsoever in respect of any products purchased through unauthorized sales channel.
6. Diodes products and technology may not be used for or incorporated into any products or systems whose manufacture, use or sale is prohibited under any applicable laws and regulations. Should customers or users use Diodes products in contravention of any applicable laws or regulations, or for any unintended or unauthorized application, customers and users will (a) be solely responsible for any damages, losses or penalties arising in connection therewith or as a result thereof, and (b) indemnify and hold Diodes and its representatives and agents harmless against any and all claims, damages, expenses, and attorney fees arising out of, directly or indirectly, any claim relating to any noncompliance with the applicable laws and regulations, as well as any unintended or unauthorized application.
7. While efforts have been made to ensure the information contained in this document is accurate, complete and current, it may contain technical inaccuracies, omissions and typographical errors. Diodes does not warrant that information contained in this document is error-free and Diodes is under no obligation to update or otherwise correct this information. Notwithstanding the foregoing, Diodes reserves the right to make modifications, enhancements, improvements, corrections or other changes without further notice to this document and any product described herein. This document is written in English but may be translated into multiple languages for reference. Only the English version of this document is the final and determinative format released by Diodes.
8. Any unauthorized copying, modification, distribution, transmission, display or other use of this document (or any portion hereof) is prohibited. Diodes assumes no responsibility for any losses incurred by the customers or users or any third parties arising from any such unauthorized use.

Copyright © 2020 Diodes Incorporated

www.diodes.com

Looking for pricing, stock, or lifecycle information?

Click below to explore more details on WIN SOURCE:

- ⊖ [View ZXMS6005SGQTA on WIN SOURCE](#)
- ⊖ [Diodes Incorporated Information](#)

Optimize Your Supply Chain with WIN SOURCE Solutions

- ✓ Global Sourcing Solution
- ✓ Obsolete Management
- ✓ Cost Control Management
- ✓ Shortage Management
- ✓ Alternative Solution
- ✓ Excess Inventory Management