



**THE DATASHEET OF
PG600J_R2_00001**





PG600A~PG600M

GLASS PASSIVATED JUNCTION PLASTIC RECTIFIERS

VOLTAGE 50 to 1000 Volt **CURRENT** 6 Ampere

P-600 Unit: inch(mm)

FEATURES

- High surge current capability.
- Plastic package has Underwriters Laboratory Flammability Classification 94V-O utilizing Flame Retardant Epoxy Molding Compound.
- Lead free in compliance with EU RoHS 2.0
- Green molding compound as per IEC 61249 standard

MECHANICAL DATA

- Case: Molded plastic, P600
- Terminals: Axial leads, solderable to MIL-STD-750, Method 2026
- Polarity: Color Band denotes cathode end
- Weight: 0.0719 ounce, 2.04 gram

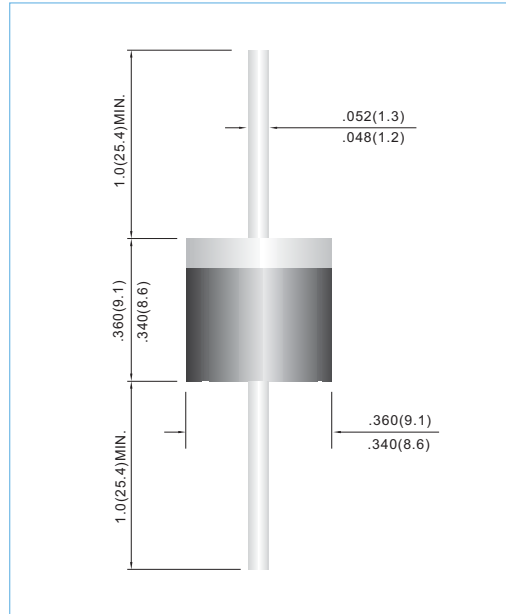

MAXIMUM RATINGS AND ELECTRICAL CHARACTERISTICS

Ratings at 25°C ambient temperature unless otherwise specified.
Resistive or inductive load, 60Hz.

PARAMETER	SYMBOL	PG600A	PG600B	PG600D	PG600G	PG600J	PG600K	PG600M	UNITS
Maximum Recurrent Peak Reverse Voltage	V_{RRM}	50	100	200	400	600	800	1000	V
Maximum RMS Voltage	V_{RMS}	35	70	140	280	420	560	700	V
Maximum DC Blocking Voltage	V_{DC}	50	100	200	400	600	800	1000	V
Maximum Average Forward Current 0.375" (9.5mm) lead length	$I_{F(AV)}$	6.0							A
Peak Forward Surge Current: 8.3ms single half sine-wave superimposed on rated load (Note 1)	I_{FSM}	300							A
Maximum Forward Voltage at 6A	V_F	1.0							V
Maximum DC Reverse Current $T_J=25^{\circ}C$ at Rated DC Blocking Voltage $T_J=100^{\circ}C$	I_R	1.0 300							μA
Typical Junction Capacitance (Note 2)	C_J	150							pF
Typical Thermal Resistance (Note 3)	$R_{\theta JA}$ $R_{\theta JL}$	20 4.0							$^{\circ}C / W$
Operating and Storage Temperature Range	T_J, T_{STG}	-55 to +150							$^{\circ}C$

NOTES: 1. Peak forward surge current, per 8.3ms single half-sine-wave superimposed on rated load (JEDEC method)
2. Measured at 1 MHz and applied reverse voltage of 4 VDC
3. Thermal resistance from junction to ambient and from junction to lead length 0.375" (9.5mm) P.C.B. mounted with 1.1 x 1.1 (30 x 30mm) copper pads.



PG600A~PG600M

RATING AND CHARACTERISTIC CURVES

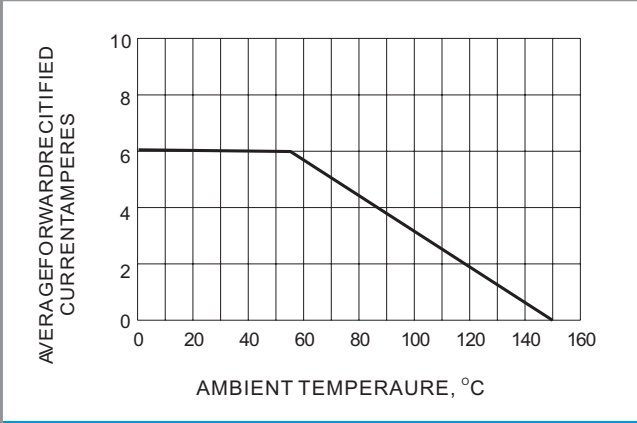

Fig.1- FORWARD CURRENT DERATING CURVE

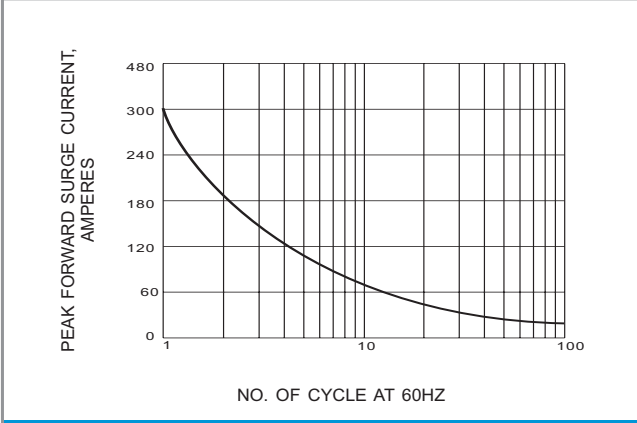

Fig.2- MAXIMUM FORWARD SURGE CURRENT

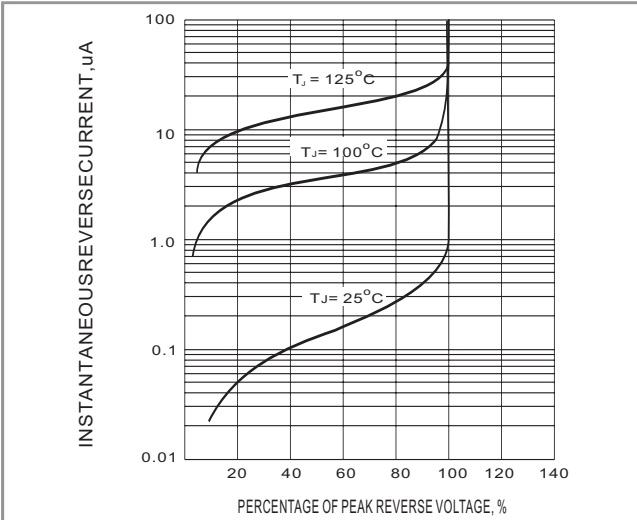

Fig.3- TYPICAL REVERSE CHARACTERISTIC

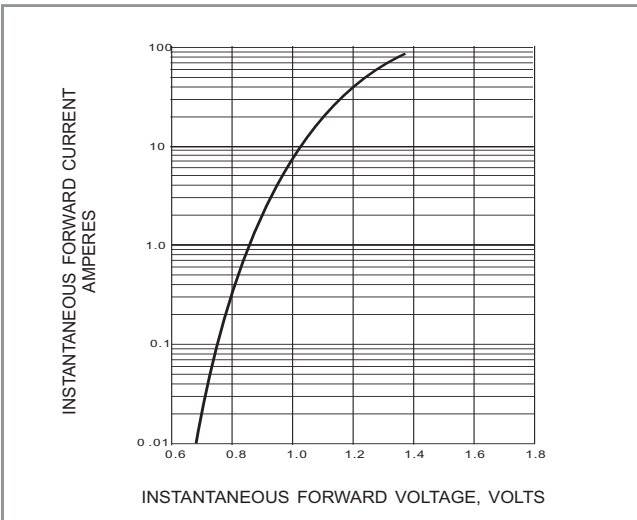

Fig.4- TYPICAL INSTANTANEOUS FORWARD CHARACTERISTIC



PG600A~PG600M

Part No Packing Code Version

Part No Packing Code	Package Type	Packing Type	Marking	Version
PG600A_AY_00001	P-600	400 pcs / Ammo	PG600A	Halogen free





PG600A~PG600M

Disclaimer

- Reproducing and modifying information of the document is prohibited without permission from Panjit International Inc..
- Panjit International Inc. reserves the rights to make changes of the content herein the document anytime without notification. Please refer to our website for the latest document.
- Panjit International Inc. disclaims any and all liability arising out of the application or use of any product including damages incidentally and consequentially occurred.
- Panjit International Inc. does not assume any and all implied warranties, including warranties of fitness for particular purpose, non-infringement and merchantability.
- Applications shown on the herein document are examples of standard use and operation. Customers are responsible in comprehending the suitable use in particular applications. Panjit International Inc. makes no representation or warranty that such applications will be suitable for the specified use without further testing or modification.
- The products shown herein are not designed and authorized for equipments requiring high level of reliability or relating to human life and for any applications concerning life-saving or life-sustaining, such as medical instruments, transportation equipment, aerospace machinery et cetera. Customers using or selling these products for use in such applications do so at their own risk and agree to fully indemnify Panjit International Inc. for any damages resulting from such improper use or sale.
- Since Panjit uses lot number as the tracking base, please provide the lot number for tracking when complaining.

Looking for pricing, stock, or lifecycle information?

Click below to explore more details on WIN SOURCE:

-  [View PG600J_R2_00001 on WIN SOURCE](#)
-  [Panjit Information](#)

Optimize Your Supply Chain with WIN SOURCE Solutions

-  Global Sourcing Solution
-  Obsolete Management
-  Cost Control Management
-  Shortage Management
-  Alternative Solution
-  Excess Inventory Management