







**THE DATASHEET OF  
PA4334.222NLT**



# SMT Power Inductor

Shielded Drum Core - PA4334.XXXNLT Series



-  Height: 1.2mm Max
-  Footprint: 3.2mm x 3.2mm Max
-  Current Rating: up to 3.0A
-  Inductance Range: 0.22uH to 100uH
-  Shielded magnetic circuit reduces leakage flux, Fe base metal core enables high saturation and metalized core termination results in excellent shock resistance.

Electrical Specifications @ 25°C - Operating Temperature -40°C to +125°C

Part Number	Inductance 1MHz, 1V  uH	Rated Current  A	Min. Self-Resonant Frequency  MHz	DC Resistance		Saturation Current (20°C)  A	Heating Current  A
				MAX.	TYP.		
				mΩ	mΩ		ΔT ≈ 40°C
PA4334.221NLT	0.22 ± 30%	3.00	328	22	17	5.30	3.00
PA4334.821NLT	0.82 ± 30%	2.05	107	39	30	2.05	2.47
PA4334.102NLT	1.0 ± 30%	1.87	89	52	40	1.87	2.20
PA4334.122NLT	1.2 ± 30%	2.01	83	59	45	2.22	2.01
PA4334.152NLT	1.5 ± 30%	1.62	71	59	45	1.62	2.01
PA4334.182NLT	1.8 ± 30%	1.30	65	82	63	1.30	1.65
PA4334.222NLT	2.2 ± 30%	1.20	55	98	75	1.20	1.55
PA4334.242NLT	2.4 ± 30%	1.15	47	88	68	1.15	1.60
PA4334.272NLT	2.7 ± 20%	1.14	54	110	85	1.14	1.48
PA4334.332NLT	3.3 ± 20%	1.05	46	130	100	1.05	1.36
PA4334.362NLT	3.6 ± 20%	1.05	36	130	100	1.05	1.36
PA4334.392NLT	3.9 ± 20%	1.00	53	189	145	1.00	1.24
PA4334.472NLT	4.7 ± 20%	0.90	31	156	120	0.90	1.24
PA4334.682NLT	6.8 ± 20%	0.75	30	247	190	0.75	0.98
PA4334.103NLT	10 ± 20%	0.60	23	345	265	0.60	0.83
PA4334.123NLT	12 ± 20%	0.48	20	449	345	0.48	0.73
PA4334.153NLT	15 ± 20%	0.45	22	468	360	0.45	0.71
PA4334.183NLT	18 ± 20%	0.43	16	709	545	0.43	0.58
PA4334.223NLT	22 ± 20%	0.42	22	839	645	0.42	0.53
PA4334.273NLT	27 ± 20%	0.35	12	1131	870	0.35	0.47

# SMT Power Inductor

Shielded Drum Core - PA4334.XXXNLT Series

## Electrical Specifications @ 25°C - Operating Temperature -40°C to +125°C

Part Number	Inductance 1MHz, 1V uH	Rated Current A	Min. Self-Resonant Frequency MHz	DC Resistance		Saturation Current (20°C) A	Heating Current A
				MAX.	TYP.		
				mΩ	mΩ		$\Delta T \approx 40^\circ C$
PA4334.333NLT	33 ± 20%	0.36	12	1138	875	0.36	0.46
PA4334.363NLT	36 ± 20%	0.34	10	1235	950	0.34	0.44
PA4334.393NLT	39 ± 20%	0.37	10	1729	1330	0.30	0.37
PA4334.473NLT	47 ± 20%	0.27	11	1885	1450	0.27	0.35
PA4334.563NLT	56 ± 20%	0.26	9	1794	1380	0.26	0.28
PA4334.683NLT	68 ± 20%	0.24	7	2171	1670	0.24	0.33
PA4334.823NLT	82 ± 20%	0.17	7	3302	2540	0.17	0.27
PA4334.104NLT	100 ± 20%	0.21	5	3718	2860	0.21	0.25

### Notes:

- Actual temperature of the component during system operation (ambient plus temperature rise) must be within the standard operating range.
- The rated current as listed is either the saturation current (@ 20°C) or the heating current ( $\Delta T \approx 40^\circ C$ ) depending on which value is lower.
- The saturation current is the current at which the initial inductance drops approximately 30% at the stated ambient temperature. This current is determined by placing the component in the specified ambient environment and applying a short duration pulse current (to eliminate self-heating effect) to the component.
- The heating current is the DC current required to raise the component temperature by approximately 40°C. Take note that the components' performance varies depending on the system condition. It is suggested that the component be tested at the system level, to verify the temperature rise of the component during system operation.
- Maximum voltage across terminals to be limited to <40Vdc

## Mechanical

### PA4334.XXXNLT

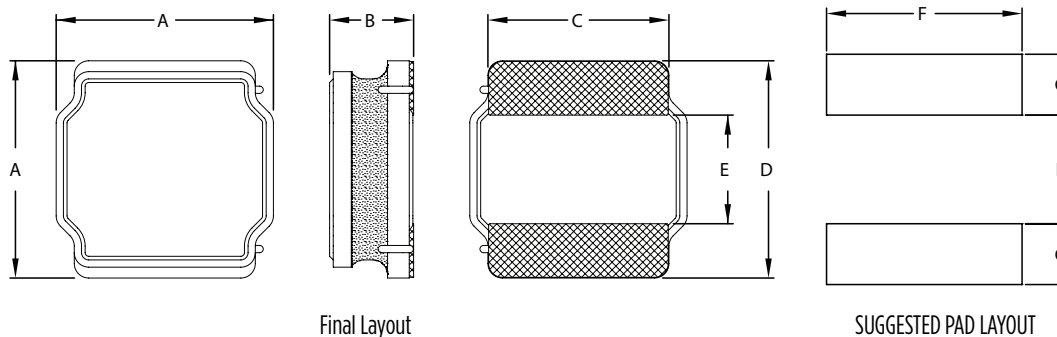

Series	A	B	C	D	E	F	G	H
PA4334.XXXNLT	3.2 MAX	1.2 MAX	(2.5)	(3.0)	(1.5)	(2.7)	(0.8)	(1.5)

All Dimensions in mm.

# SMT Power Inductor

Shielded Drum Core - PA4334.XXXNLT Series



a YAGEO company

## TAPE & REEL INFO

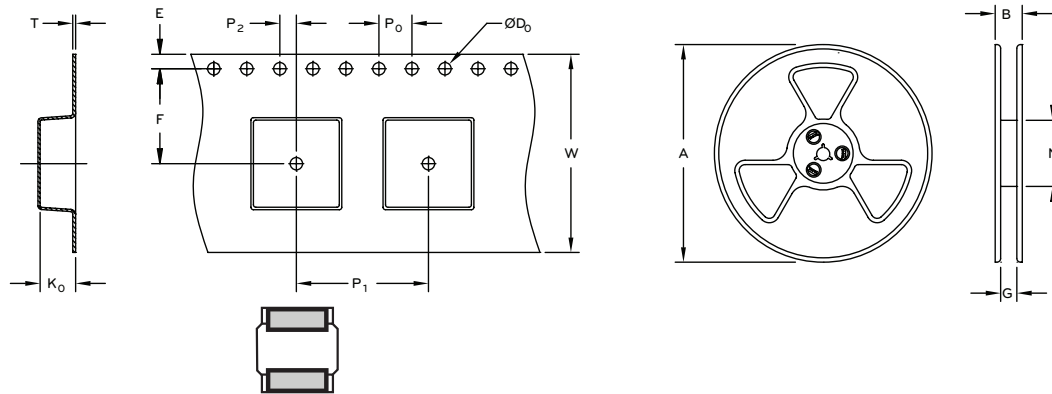

## SURFACE MOUNTING TYPE, REEL/TAPE LIST

	REEL SIZE (mm)				TAPE SIZE (mm)									QTY PCS/REEL
	A	B	G	N	E	F	D <sub>0</sub>	P <sub>1</sub>	P <sub>0</sub>	P <sub>2</sub>	W	T	K <sub>0</sub>	
PA4334.XXXNLT	Ø178	14.4	8.4	58	1.75	3.5	1.5	4	4	2	8	0.25	1.6	2000

## Typical Performance Curves

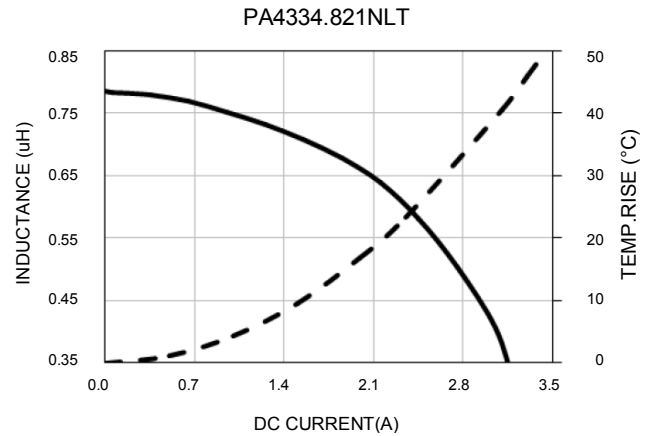
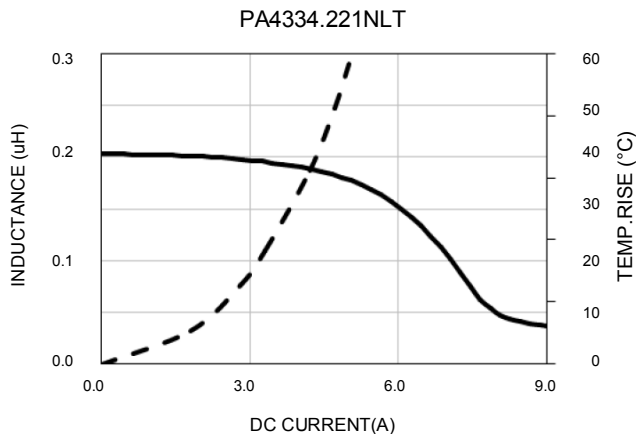

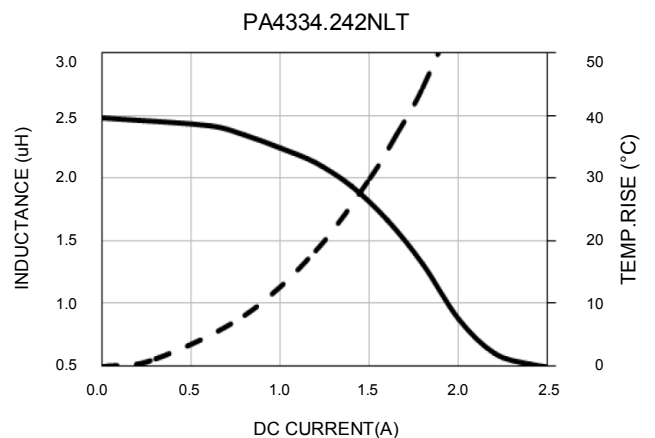
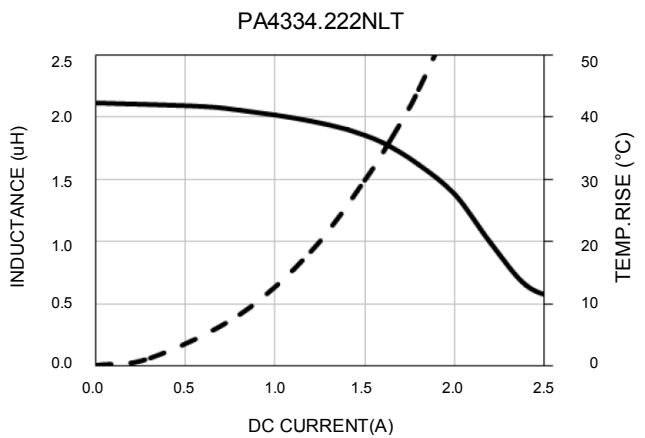
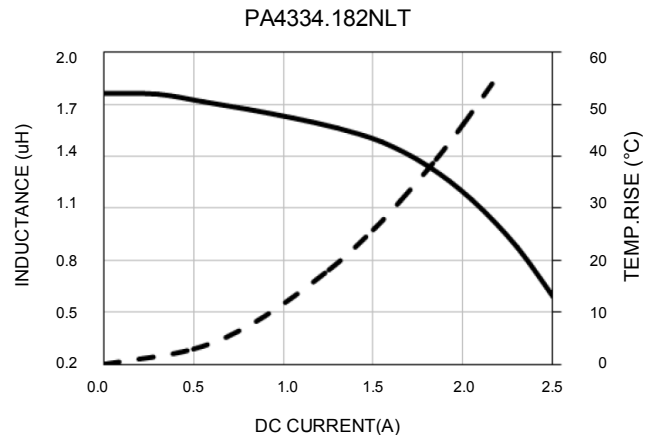
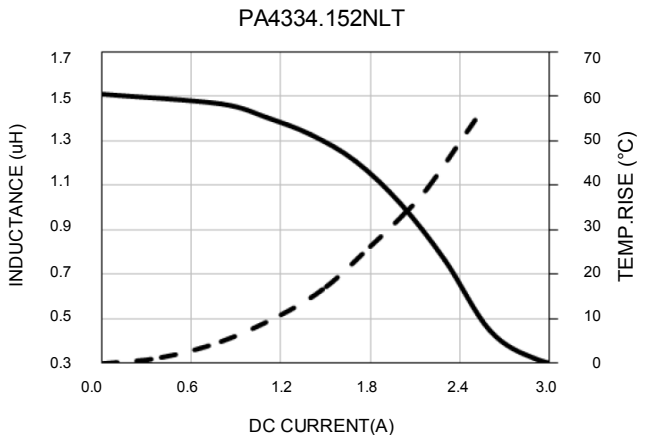
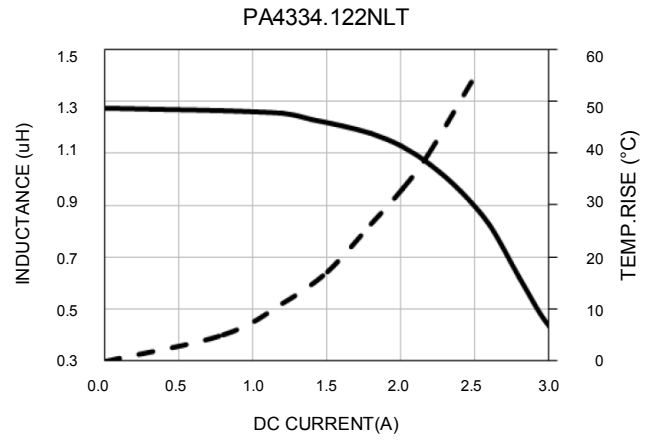
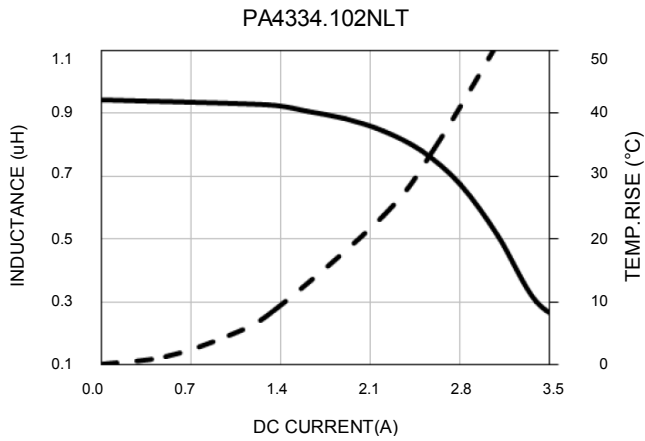

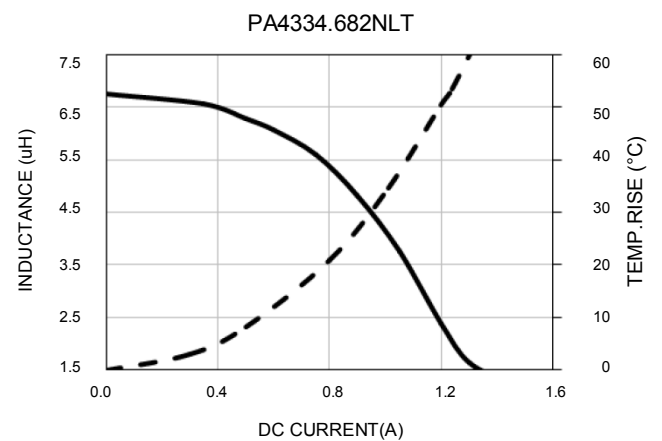
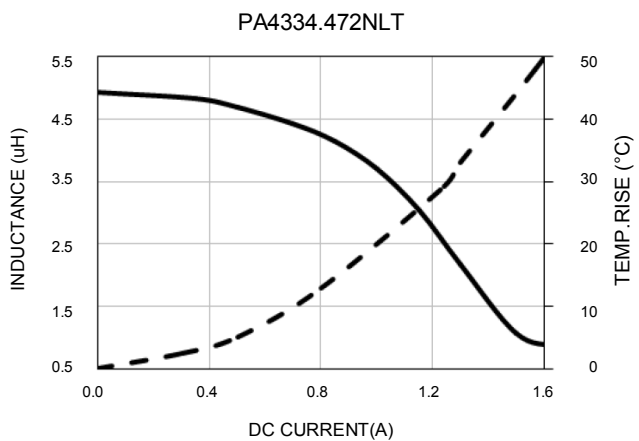
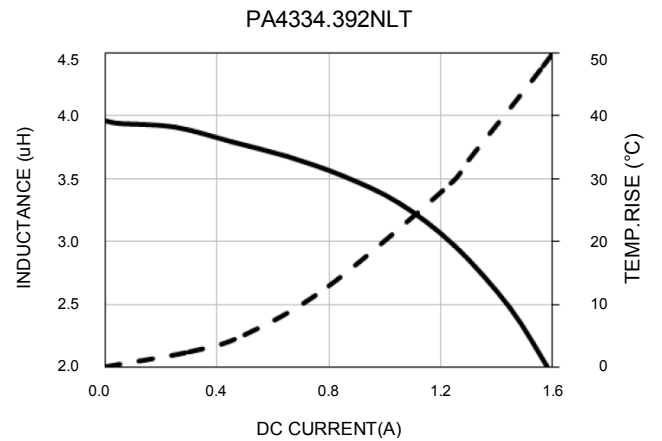
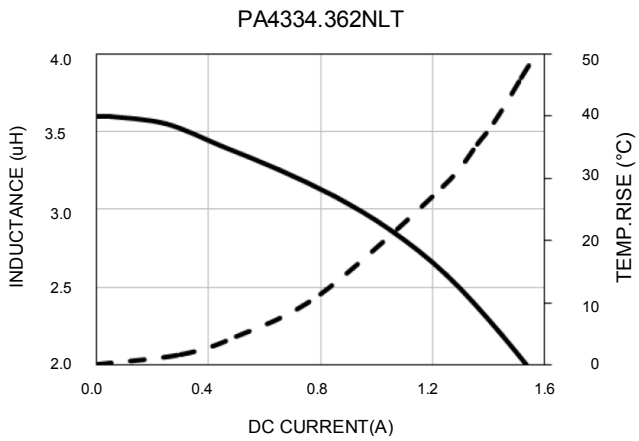
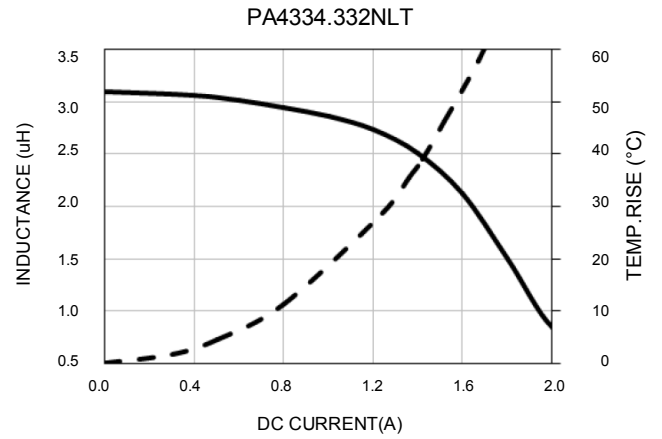
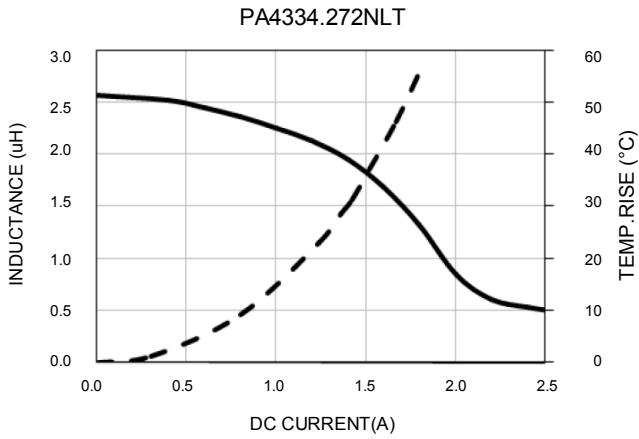

PA4334.103NLT

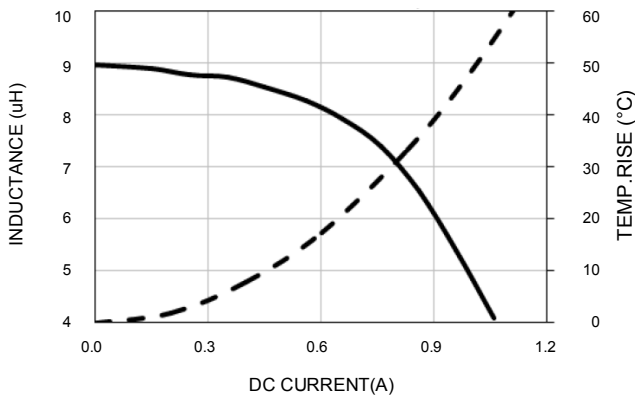

PA4334.123NLT

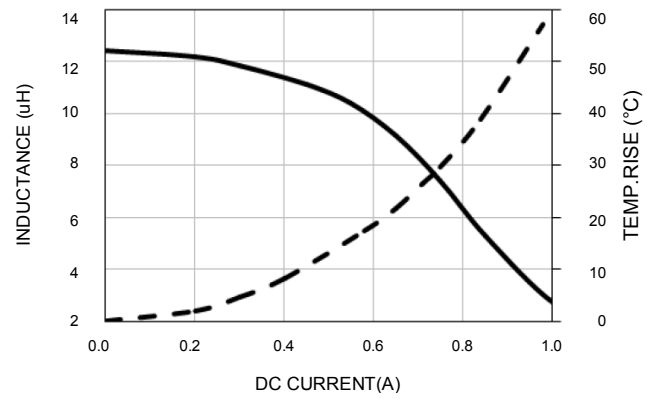

PA4334.153NLT

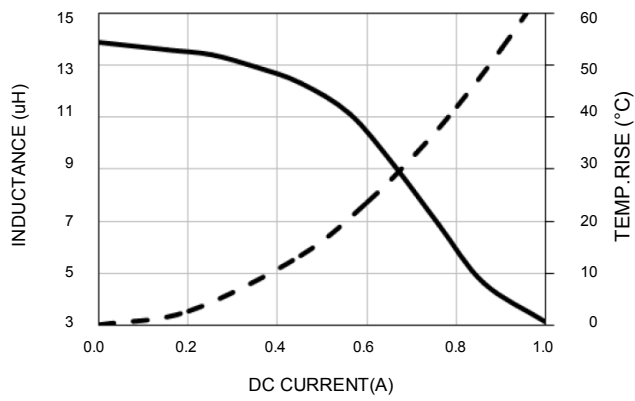

PA4334.183NLT

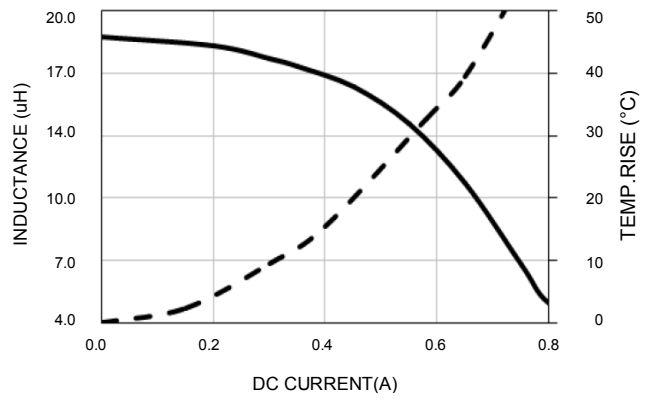

PA4334.223NLT

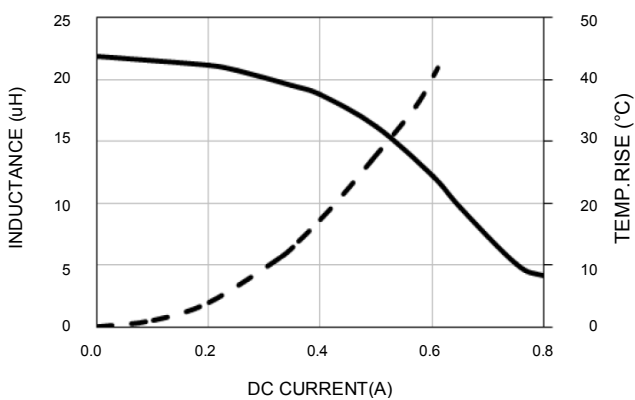

PA4334.273NLT

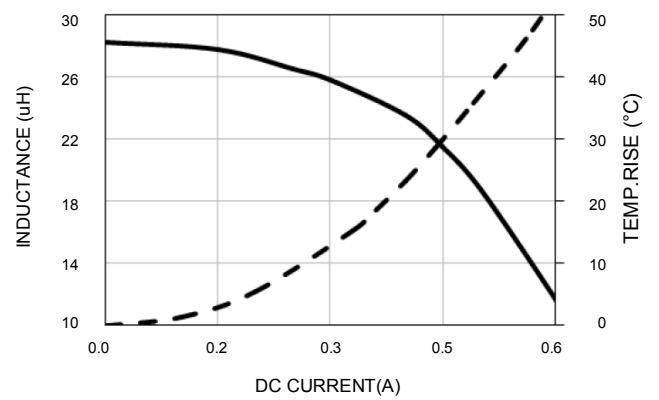

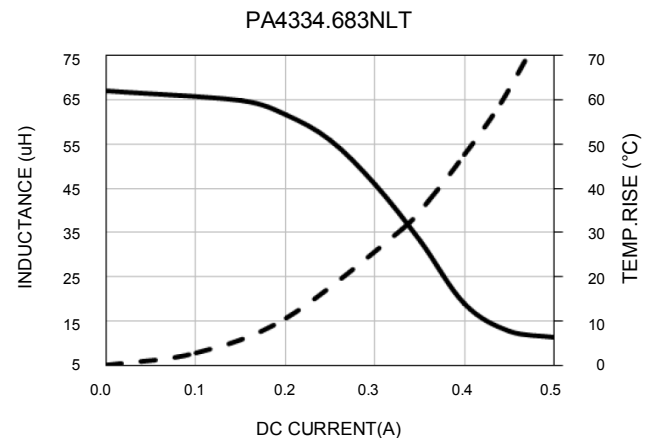
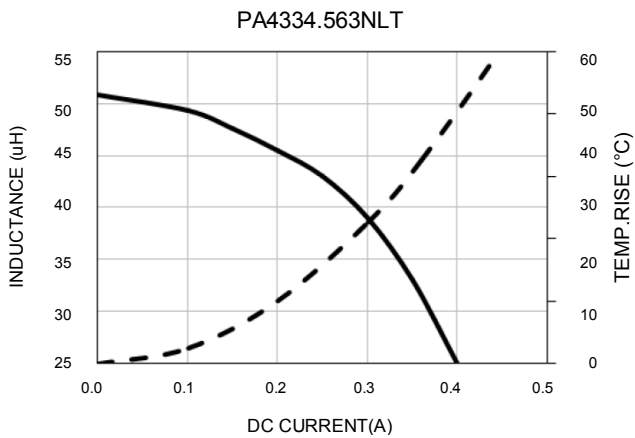
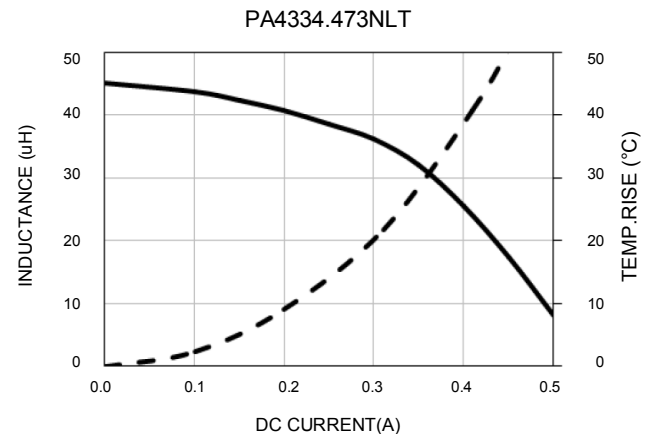
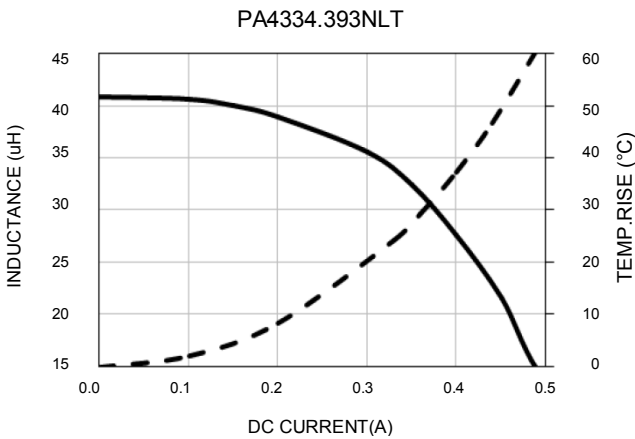
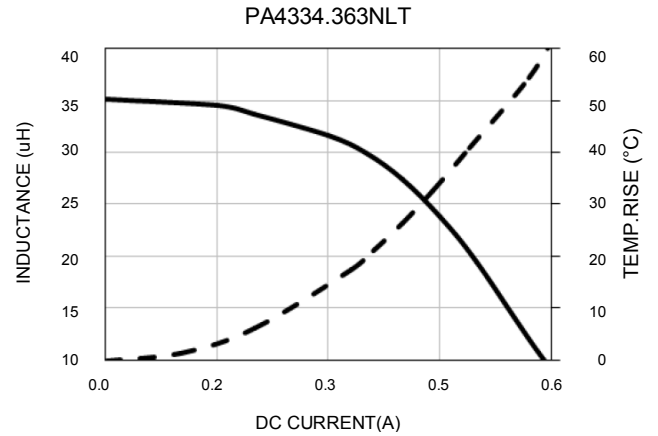
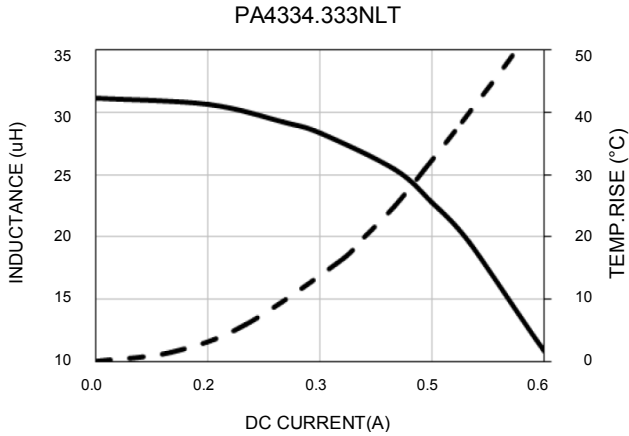

# SMT Power Inductor

Shielded Drum Core - PA4334.XXXNLT Series

PA4334.823NLT

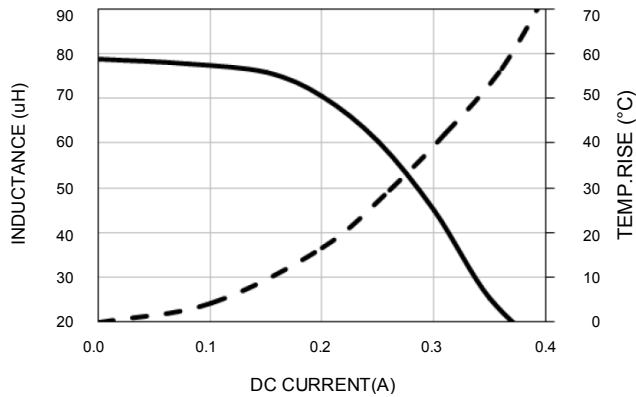

PA4334.104NLT

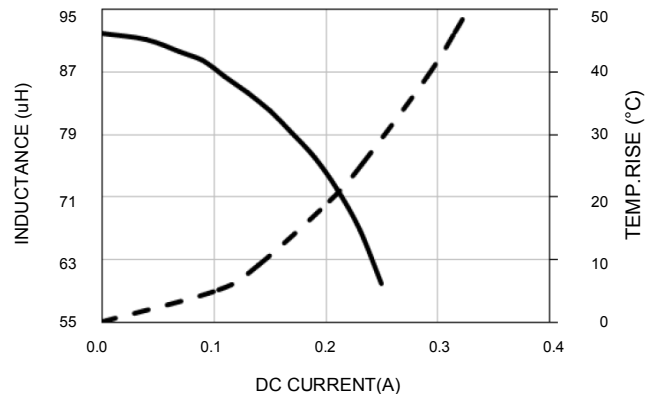

## For More Information

Americas - [prodinfo\\_power\\_americas@yageo.com](mailto:prodinfo_power_americas@yageo.com) | Europe - [prodinfo\\_power\\_emea@yageo.com](mailto:prodinfo_power_emea@yageo.com) | Asia - [prodinfo\\_power\\_asia@yageo.com](mailto:prodinfo_power_asia@yageo.com)

Performance warranty of products offered on this data sheet is limited to the parameters specified. Data is subject to change without notice. Other brand and product names mentioned herein may be trademarks or registered trademarks of their respective owners. © Copyright, 2023. Pulse Electronics, Inc. All rights reserved.

YAGEO Corporation and its affiliates do not recommend the use of commercial or automotive grade products for high reliability applications or manned space flight.

## Looking for pricing, stock, or lifecycle information?

Click below to explore more details on WIN SOURCE:

 [View PA4334.222NLT on WIN SOURCE](#)

 [Pulse Information](#)

## Optimize Your Supply Chain with WIN SOURCE Solutions

-  Global Sourcing Solution
-  Obsolete Management
-  Cost Control Management
-  Shortage Management
-  Alternative Solution
-  Excess Inventory Management