



**THE DATASHEET OF
SZESD7361XV2T1G**



ESD Protection Diode

Low Capacitance ESD Protection Diode for High Speed Data Line

ESD7361, SZESD7361

The ESD7361 Series ESD protection diodes are designed to protect high speed data lines from ESD. Ultra-low capacitance make this device an ideal solution for protecting voltage sensitive high speed data lines.

Features

- Low Capacitance (0.55 pF Max, I/O to GND)
- Protection for the Following IEC Standards:
 - ◆ IEC61000-4-2 (ESD): Level 4 ±15 kV Contact
 - ◆ IEC61000-4-4 (EFT): 40 A -5/50 ns
 - ◆ IEC61000-4-5 (Lightning): 1 A (8/20 μs)
- ISO 10605 (ESD) 330 pF/2 kΩ ±15 kV Contact
- SZ Prefix for Automotive and Other Applications Requiring Unique Site and Control Change Requirements; AEC-Q101 Qualified and PPAP Capable
- These Devices are Pb-Free, Halogen Free/BFR Free and are RoHS Compliant

Typical Applications

- Wireless Charger
- Near Field Communications

MAXIMUM RATINGS (T_J = 25°C unless otherwise noted)

Rating	Symbol	Value	Unit
Operating Junction Temperature Range	T _J	-55 to +125	°C
Storage Temperature Range	T _{stg}	-55 to +150	°C
Lead Solder Temperature – Maximum (10 Seconds)	T _L	260	°C
IEC 61000-4-2 Contact (ESD)	ESD	±15	kV
IEC 61000-4-2 Air (ESD)	ESD	±15	kV
ISO 10605 330 pF/2 kΩ Contact (ESD)	ESD	±15	kV

Stresses exceeding those listed in the Maximum Ratings table may damage the device. If any of these limits are exceeded, device functionality should not be assumed, damage may occur and reliability may be affected.

MARKING DIAGRAMS



SOD-323
CASE 477



SOD-523
CASE 502

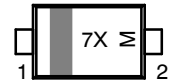

SOD-923
CASE 514AB

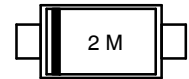

X, XX = Specific Device Code
M = Date Code

PIN CONFIGURATION AND SCHEMATIC

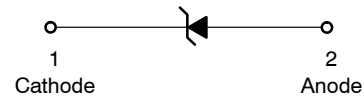

ORDERING INFORMATION

See detailed ordering and shipping information on page 6 of this data sheet.

ESD7361, SZESD7361

ELECTRICAL CHARACTERISTICS

($T_A = 25^\circ\text{C}$ unless otherwise noted)

Symbol	Parameter
I_{PP}	Maximum Reverse Peak Pulse Current
V_C	Clamping Voltage @ I_{PP}
V_{RWM}	Working Peak Reverse Voltage
I_R	Maximum Reverse Leakage Current @ V_{RWM}
V_{BR}	Breakdown Voltage @ I_T
I_T	Test Current

*See Application Note AND8308/D for detailed explanations of datasheet parameters.

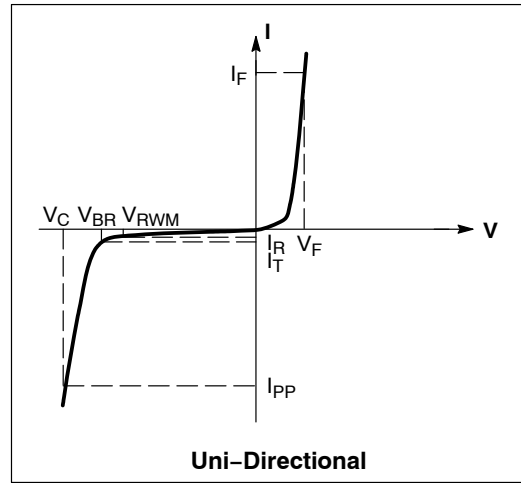

ELECTRICAL CHARACTERISTICS ($T_A = 25^\circ\text{C}$ unless otherwise specified)

Parameter	Symbol	Conditions	Min	Typ	Max	Unit
Reverse Working Voltage	V_{RWM}			5	16	V
Breakdown Voltage	V_{BR}	$I_T = 1 \text{ mA}$; pin 1 to pin 2	16.5			V
Reverse Leakage Current	I_R	$V_{RWM} = 5.0 \text{ V}$ $V_{RWM} = 15 \text{ V}$		<1 20	1000 1000	nA nA
Clamping Voltage (Note 2)	V_C	$I_{PP} = 8 \text{ A}$		31		V
Clamping Voltage (Note 2)	V_C	$I_{PP} = 16 \text{ A}$		34		V
Junction Capacitance	C_J	$V_R = 0 \text{ V}$, $f = 1 \text{ MHz}$ $V_R = 0 \text{ V}$, $f < 1 \text{ GHz}$			0.55 0.55	pF
Dynamic Resistance	R_{DYN}	TLP Pulse		0.735		Ω
Insertion Loss		$f = 1 \text{ MHz}$ $f = 5 \text{ GHz}$		0.01 2		dB

Product parametric performance is indicated in the Electrical Characteristics for the listed test conditions, unless otherwise noted. Product performance may not be indicated by the Electrical Characteristics if operated under different conditions.

- For test procedure see Figures 9 and 10 and application note AND8307/D.
- ANSI/ESD STM5.5.1 – Electrostatic Discharge Sensitivity Testing using Transmission Line Pulse (TLP) Model.
TLP conditions: $Z_0 = 50 \Omega$, $t_p = 100 \text{ ns}$, $t_r = 4 \text{ ns}$, averaging window; $t_1 = 30 \text{ ns}$ to $t_2 = 60 \text{ ns}$.

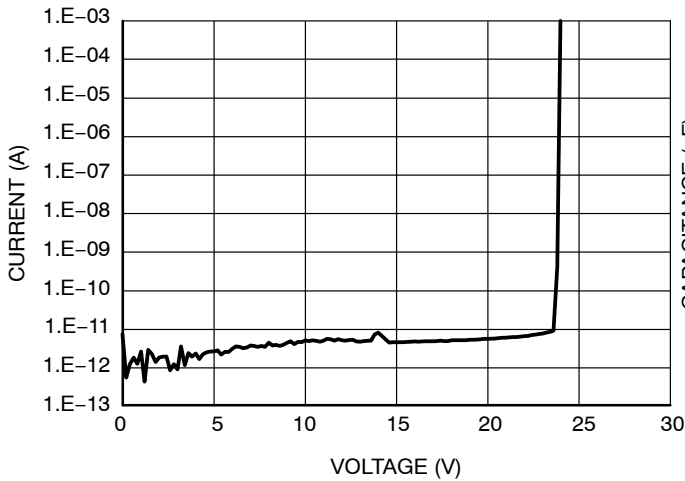

Figure 1. Typical IV Characteristics

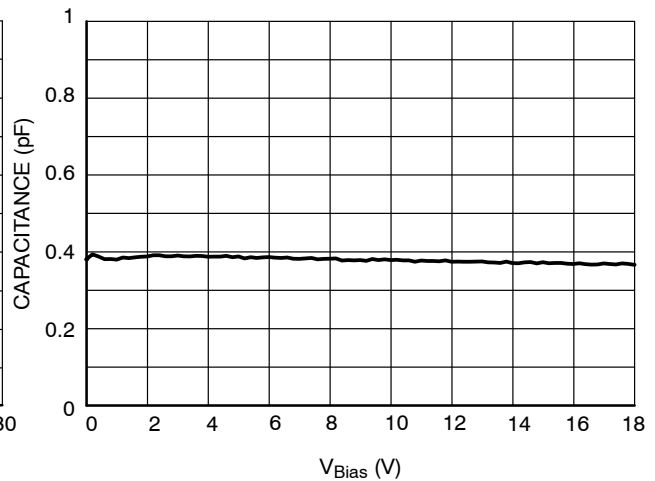
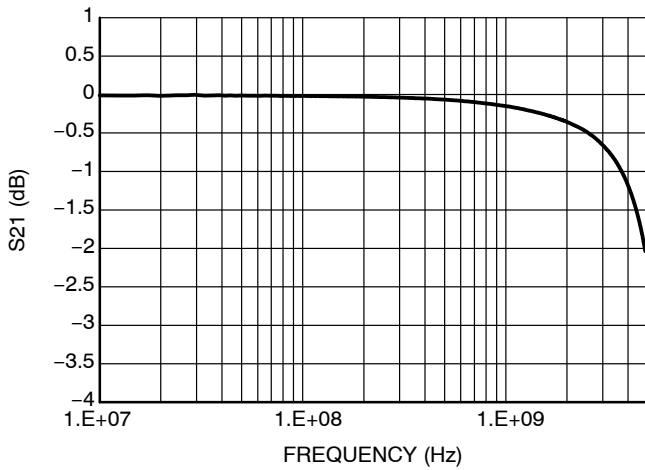
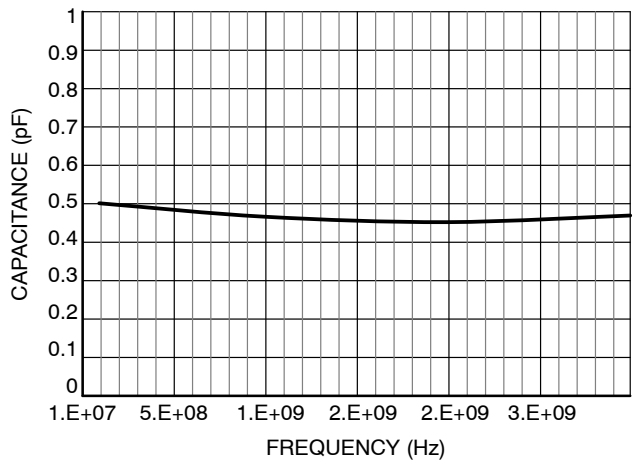

Figure 2. Typical CV Characteristics

ESD7361, SZESD7361



**Figure 3. Typical Insertion Loss
ESD7361HT1G (SOD323)**



**Figure 4. Typical Capacitance Over Frequency
ESD7361HT1G (SOD323)**

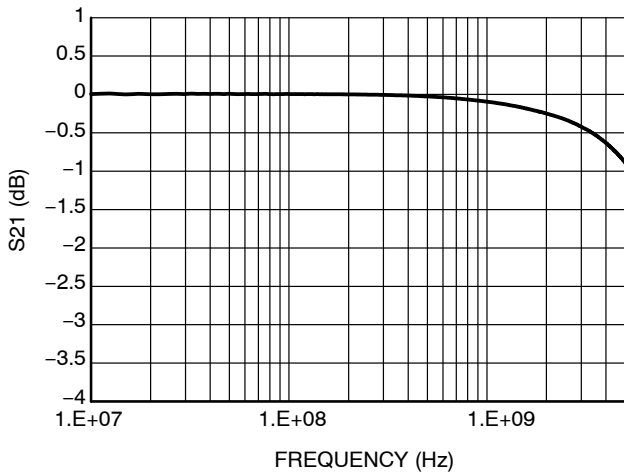

**Figure 5. Typical Insertion Loss
ESD7361XV2T1G (SOD523)**

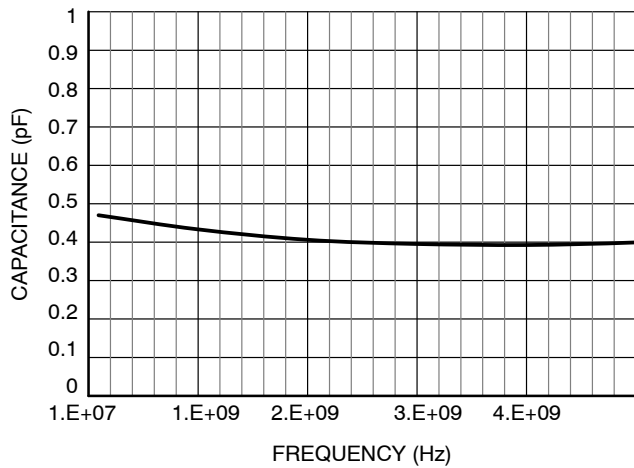

**Figure 6. Typical Capacitance Over Frequency
ESD7361XV2T1G (SOD523)**

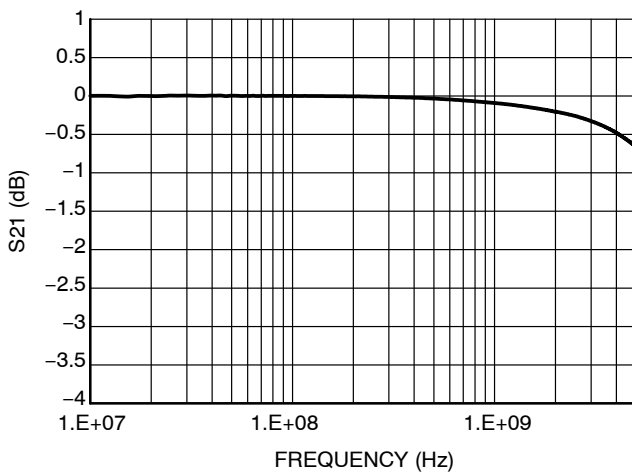

**Figure 7. Typical Insertion Loss
ESD7361P2T5G (SOD923)**

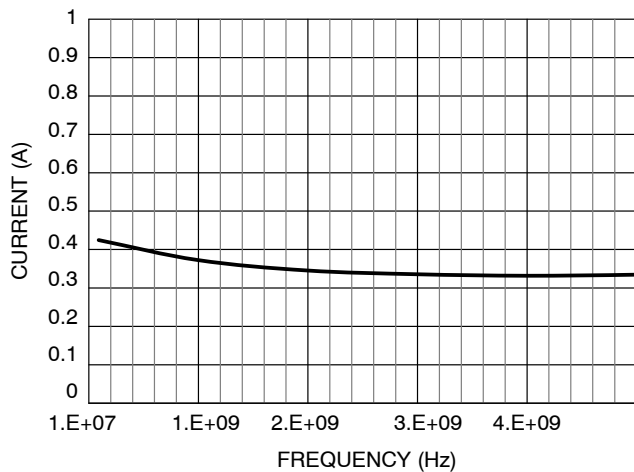

**Figure 8. Typical Capacitance Over Frequency
ESD7361P2T5G (SOD923)**

ESD7361, SZESD7361

IEC 61000-4-2 Spec.

Level	Test Voltage (kV)	First Peak Current (A)	Current at 30 ns (A)	Current at 60 ns (A)
1	2	7.5	4	2
2	4	15	8	4
3	6	22.5	12	6
4	8	30	16	8

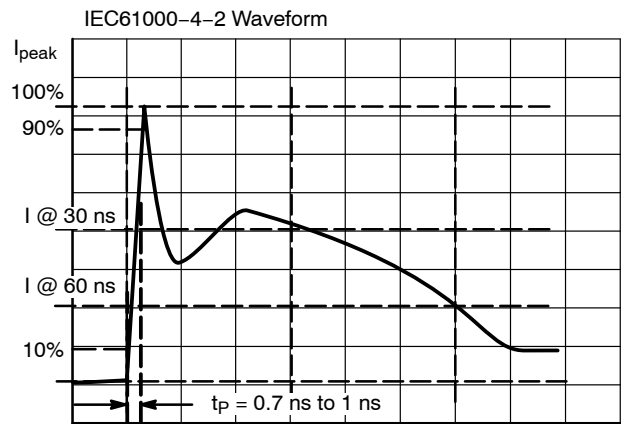

Figure 9. IEC61000-4-2 Spec

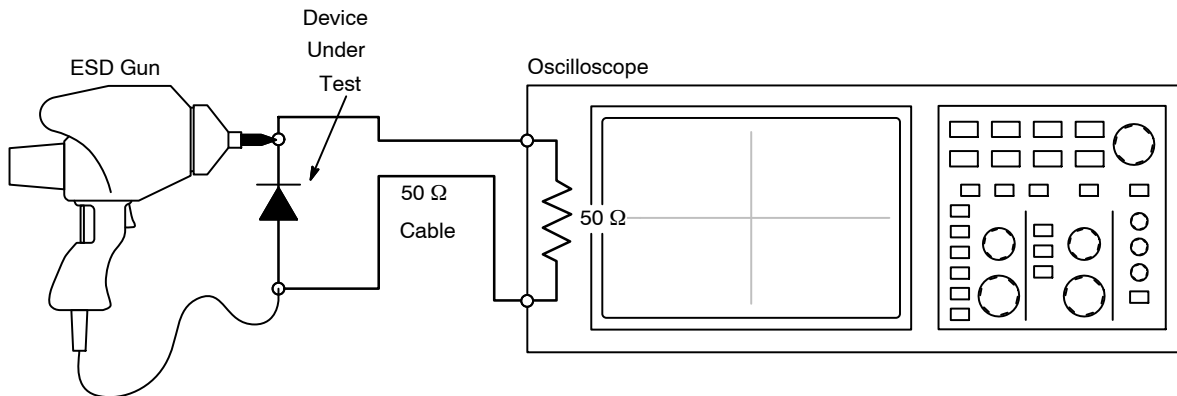

Figure 10. Diagram of ESD Clamping Voltage Test Setup

The following is taken from Application Note AND8308/D – Interpretation of Datasheet Parameters for ESD Devices.

ESD Voltage Clamping

For sensitive circuit elements it is important to limit the voltage that an IC will be exposed to during an ESD event to as low a voltage as possible. The ESD clamping voltage is the voltage drop across the ESD protection diode during an ESD event per the IEC61000-4-2 waveform. Since the IEC61000-4-2 was written as a pass/fail spec for larger

systems such as cell phones or laptop computers it is not clearly defined in the spec how to specify a clamping voltage at the device level. **onsemi** has developed a way to examine the entire voltage waveform across the ESD protection diode over the time domain of an ESD pulse in the form of an oscilloscope screenshot, which can be found on the datasheets for all ESD protection diodes. For more information on how **onsemi** creates these screenshots and how to interpret them please refer to AND8307/D.

ESD7361, SZESD7361

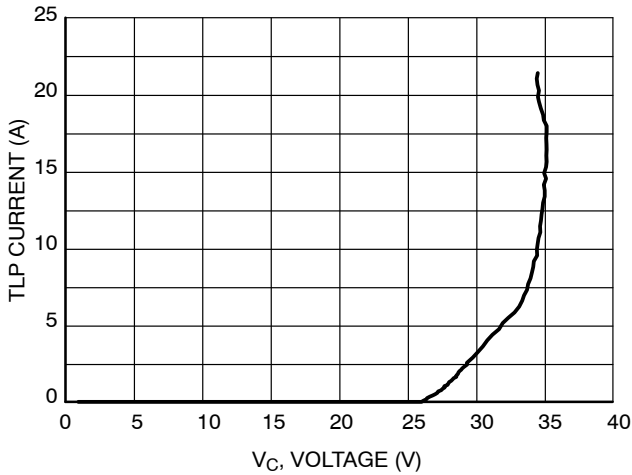

Figure 11. Positive TLP I-V Curve

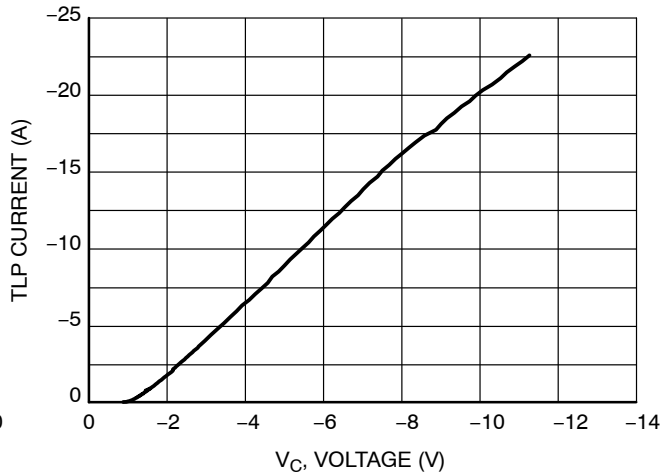

Figure 12. Negative TLP I-V Curve

NOTE: TLP parameter: $Z_0 = 50 \Omega$, $t_p = 100 \text{ ns}$, $t_r = 300 \text{ ps}$, averaging window: $t_1 = 30 \text{ ns}$ to $t_2 = 60 \text{ ns}$. V_{IEC} is the equivalent voltage stress level calculated at the secondary peak of the IEC 61000-4-2 waveform at $t = 30 \text{ ns}$ with 2 A/kV . See TLP description below for more information.

Transmission Line Pulse (TLP) Measurement

Transmission Line Pulse (TLP) provides current versus voltage (I-V) curves in which each data point is obtained from a 100 ns long rectangular pulse from a charged transmission line. A simplified schematic of a typical TLP system is shown in Figure 13. TLP I-V curves of ESD protection devices accurately demonstrate the product's ESD capability because the 10s of amps current levels and under 100 ns time scale match those of an ESD event. This is illustrated in Figure 14 where an 8 kV IEC 61000-4-2 current waveform is compared with TLP current pulses at 8 A and 16 A. A TLP I-V curve shows the voltage at which the device turns on as well as how well the device clamps voltage over a range of current levels.

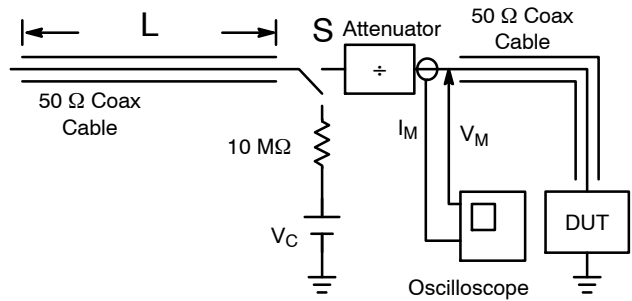

Figure 13. Simplified Schematic of a Typical TLP System

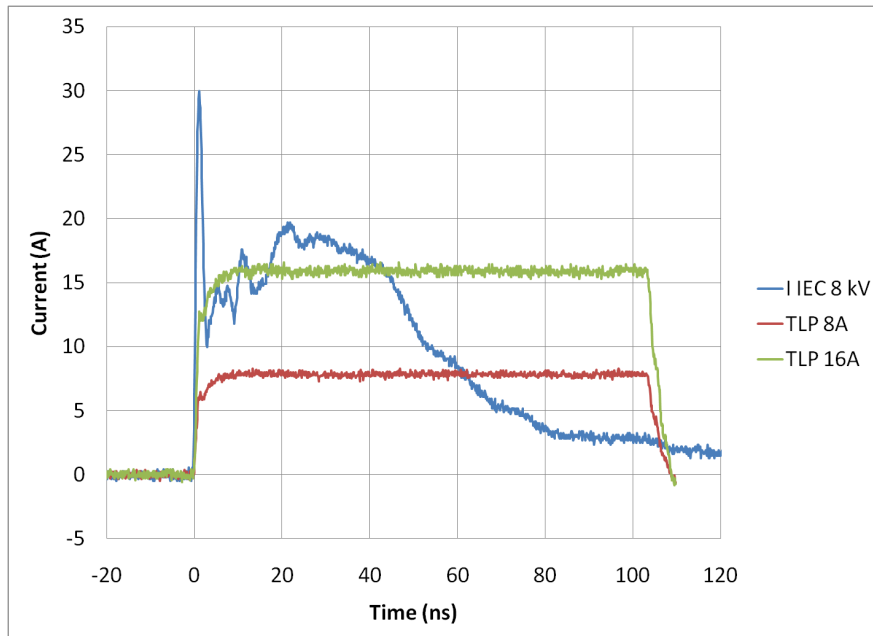

Figure 14. Comparison Between 8 kV IEC 61000-4-2 and 8 A and 16 A TLP Waveforms

ESD7361, SZESD7361

ORDERING INFORMATION

Device	Package	Shipping†
ESD7361HT1G	SOD-323 (Pb-Free)	3000 / Tape & Reel
SZESD7361HT1G*		
ESD7361XV2T1G	SOD-523 (Pb-Free)	3000 / Tape & Reel
SZESD7361XV2T1G*		
ESD7361XV2T5G		8000 / Tape & Reel
SZESD7361XV2T5G*		
ESD7361P2T5G	SOD-923 (Pb-Free)	8000 / Tape & Reel
SZESD7361P2T5G*		

†For information on tape and reel specifications, including part orientation and tape sizes, please refer to our Tape and Reel Packaging Specifications Brochure, BRD8011/D.

*SZ Prefix for Automotive and Other Applications Requiring Unique Site and Control Change Requirements; AEC-Q101 Qualified and PPAP Capable.

MECHANICAL CASE OUTLINE

PACKAGE DIMENSIONS

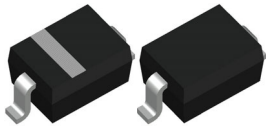

SOD-323 1.70x1.25x0.85
CASE 477
ISSUE K

DATE 11 MAR 2024

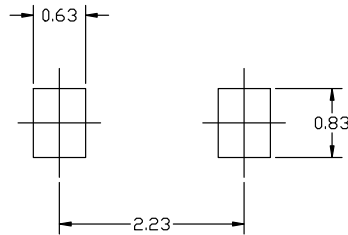
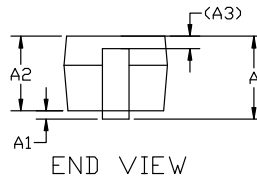
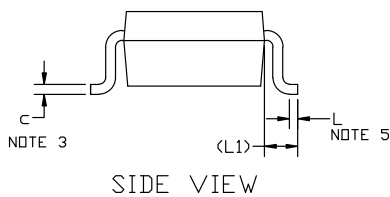
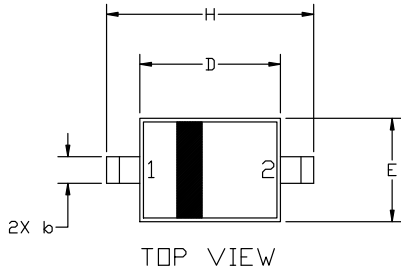

NOTES:

1. DIMENSIONING AND TOLERANCING AS PER ASME Y14.5M, 2018.
2. CONTROLLING DIMENSION: MILLIMETERS.
3. LEAD THICKNESS SPECIFIED PER L/F DRAWING WITH SOLDER PLATING.
4. DIMENSIONS A AND B DO NOT INCLUDE MOLD FLASH, PROTRUSIONS OR GATE BURRS.
5. DIMENSION L IS MEASURE FROM END OF RADIUS.

DIM	MILLIMETERS		
	MIN.	NOM.	MAX.
A	0.80	0.90	1.00
A1	0.00	0.05	0.10
A2	0.75	0.85	0.95
A3	0.15 (REF)		
b	0.25	0.32	0.4
c	0.09	0.12	0.18
D	1.60	1.70	1.80
E	1.15	1.25	1.35
H	2.30	2.50	2.70
L	0.08	---	---
L1	0.40 (REF)		

*For additional information on our Pb-Free strategy and soldering details, please download the ON Semiconductor Soldering and Mounting Techniques Reference manual, SOLDERRM/D.

GENERIC MARKING DIAGRAM*

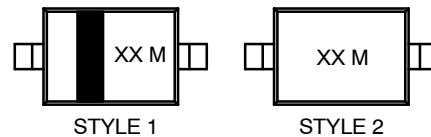

XX = Specific Device Code
M = Date Code

*This information is generic. Please refer to device data sheet for actual part marking. Pb-Free indicator, "G" or microdot "•", may or may not be present. Some products may not follow the Generic Marking.

STYLE 1: PIN 1. CATHODE (POLARITY BAND)
2. ANODE

STYLE 2: NO POLARITY

DOCUMENT NUMBER:	98ASB17533C	Electronic versions are uncontrolled except when accessed directly from the Document Repository. Printed versions are uncontrolled except when stamped "CONTROLLED COPY" in red.
DESCRIPTION:	SOD-323 1.70x1.25x0.85	PAGE 1 OF 1

onsemi and ONSEMI are trademarks of Semiconductor Components Industries, LLC dba onsemi or its subsidiaries in the United States and/or other countries. onsemi reserves the right to make changes without further notice to any products herein. onsemi makes no warranty, representation or guarantee regarding the suitability of its products for any particular purpose, nor does onsemi assume any liability arising out of the application or use of any product or circuit, and specifically disclaims any and all liability, including without limitation special, consequential or incidental damages. onsemi does not convey any license under its patent rights nor the rights of others.

MECHANICAL CASE OUTLINE PACKAGE DIMENSIONS

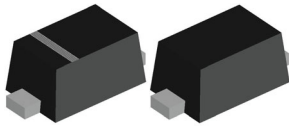

SOD-523 1.20x0.80x0.60
CASE 502
ISSUE F

DATE 08 FEB 2024

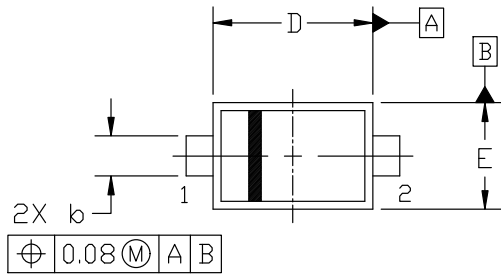

TOP VIEW

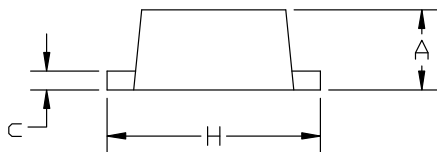

SIDE VIEW

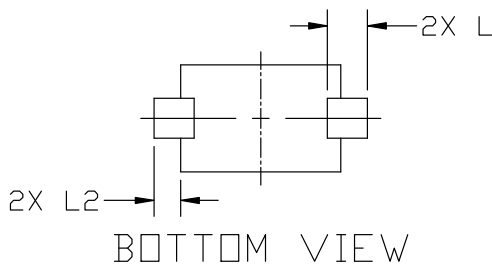

BOTTOM VIEW

NOTES:

1. DIMENSIONING AND TOLERANCING PER ASME Y14.5M, 2018.
2. CONTROLLING DIMENSION: MILLIMETERS.
3. MAXIMUM LEAD THICKNESS INCLUDES LEAD FINISH, MINIMUM LEAD THICKNESS IS THE MINIMUM THICKNESS OF BASE MATERIAL.
4. DIMENSIONS D AND E DO NOT INCLUDE MOLD FLASH, PROTRUSIONS, OR GATE BURRS.

DIM	MILLIMETERS		
	MIN.	NOM.	MAX.
A	0.50	0.60	0.70
b	0.25	0.30	0.35
c	0.07	0.14	0.20
D	1.10	1.20	1.30
E	0.70	0.80	0.90
H	1.50	1.60	1.70
L	0.30 REF		
L2	0.15	0.20	0.25

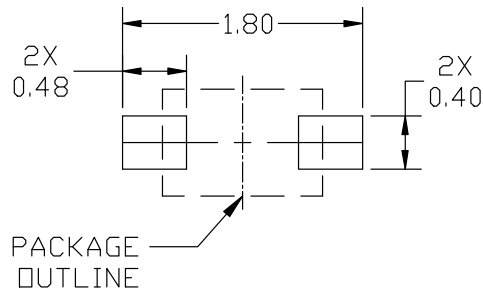

RECOMMENDED MOUNTING FOOTPRINT

GENERIC MARKING DIAGRAM*

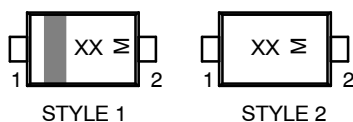

XX = Specific Device Code
M = Date Code

*This information is generic. Please refer to device data sheet for actual part marking. Pb-Free indicator, "G" or microdot "•", may or may not be present. Some products may not follow the Generic Marking.

STYLE 1: PIN 1. CATHODE (POLARITY BAND) 2. ANODE
STYLE 2: NO POLARITY

DOCUMENT NUMBER:	98AON11524D	Electronic versions are uncontrolled except when accessed directly from the Document Repository. Printed versions are uncontrolled except when stamped "CONTROLLED COPY" in red.
DESCRIPTION:	SOD-523 1.20x0.80x0.60	PAGE 1 OF 1

onsemi and ONSEMI are trademarks of Semiconductor Components Industries, LLC dba onsemi or its subsidiaries in the United States and/or other countries. onsemi reserves the right to make changes without further notice to any products herein. onsemi makes no warranty, representation or guarantee regarding the suitability of its products for any particular purpose, nor does onsemi assume any liability arising out of the application or use of any product or circuit, and specifically disclaims any and all liability, including without limitation special, consequential or incidental damages. onsemi does not convey any license under its patent rights nor the rights of others.

MECHANICAL CASE OUTLINE

PACKAGE DIMENSIONS

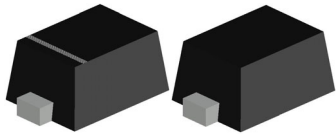

SOD-923 0.80x0.60x0.37
CASE 514AB
ISSUE E

DATE 08 FEB 2024

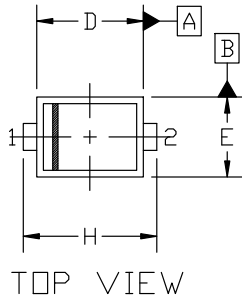

NOTES:

1. DIMENSIONING AND TOLERANCING PER ASME Y14.5M, 2018.
2. CONTROLLING DIMENSION: MILLIMETERS.
3. MAXIMUM LEAD THICKNESS INCLUDES LEAD FINISH. MINIMUM LEAD THICKNESS IS THE MINIMUM THICKNESS OF BASE MATERIAL.
4. DIMENSIONS D AND E DO NOT INCLUDE MOLD FLASH, PROTRUSIONS, OR GATE BURRS.
5. DIMENSION L WILL NOT EXCEED 0.30mm.

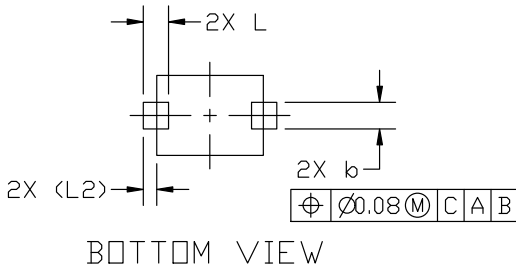
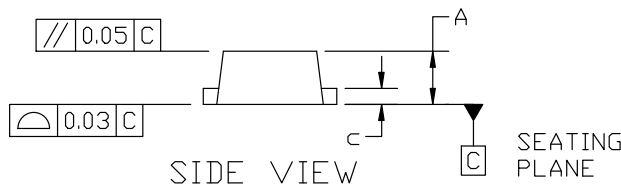

MILLIMETERS			
DIM	MIN.	NOM.	MAX.
A	0.34	0.37	0.40
b	0.15	0.20	0.25
c	0.07	0.12	0.17
D	0.75	0.80	0.85
E	0.55	0.60	0.65
H	0.95	1.00	1.05
L	0.19 REF		
L2	0.05	0.10	0.15

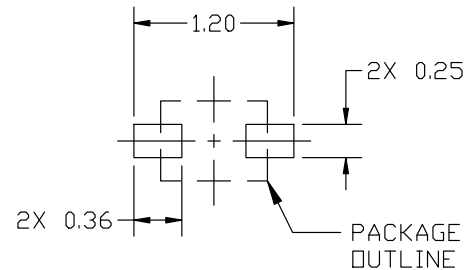

GENERIC MARKING DIAGRAM*

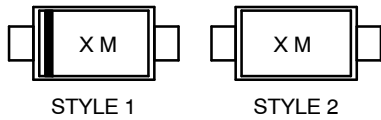

X = Specific Device Code
M = Date Code

*This information is generic. Please refer to device data sheet for actual part marking. Pb-Free indicator, "G" or microdot "•", may or may not be present. Some products may not follow the Generic Marking.

STYLE 1: PIN 1. CATHODE (POLARITY BAND)
2. ANODE

STYLE 2: NO POLARITY

RECOMMENDED MOUNTING FOOTPRINT

*For additional information on our Pb-Free strategy and soldering details, please download the [ON Semiconductor Soldering and Mounting Techniques Reference Manual, SOLDERRM/D](#).

DOCUMENT NUMBER:	98AON23284D	Electronic versions are uncontrolled except when accessed directly from the Document Repository. Printed versions are uncontrolled except when stamped "CONTROLLED COPY" in red.
DESCRIPTION:	SOD-923 0.80x0.60x0.37	PAGE 1 OF 1

onsemi and ONSEMI are trademarks of Semiconductor Components Industries, LLC dba onsemi or its subsidiaries in the United States and/or other countries. onsemi reserves the right to make changes without further notice to any products herein. onsemi makes no warranty, representation or guarantee regarding the suitability of its products for any particular purpose, nor does onsemi assume any liability arising out of the application or use of any product or circuit, and specifically disclaims any and all liability, including without limitation special, consequential or incidental damages. onsemi does not convey any license under its patent rights nor the rights of others.

onsemi, **Onsemi**, and other names, marks, and brands are registered and/or common law trademarks of Semiconductor Components Industries, LLC dba "**onsemi**" or its affiliates and/or subsidiaries in the United States and/or other countries. **onsemi** owns the rights to a number of patents, trademarks, copyrights, trade secrets, and other intellectual property. A listing of **onsemi**'s product/patent coverage may be accessed at www.onsemi.com/site/pdf/Patent-Marking.pdf. **onsemi** reserves the right to make changes at any time to any products or information herein, without notice. The information herein is provided "as-is" and **onsemi** makes no warranty, representation or guarantee regarding the accuracy of the information, product features, availability, functionality, or suitability of its products for any particular purpose, nor does **onsemi** assume any liability arising out of the application or use of any product or circuit, and specifically disclaims any and all liability, including without limitation special, consequential or incidental damages. Buyer is responsible for its products and applications using **onsemi** products, including compliance with all laws, regulations and safety requirements or standards, regardless of any support or applications information provided by **onsemi**. "Typical" parameters which may be provided in **onsemi** data sheets and/or specifications can and do vary in different applications and actual performance may vary over time. All operating parameters, including "Typicals" must be validated for each customer application by customer's technical experts. **onsemi** does not convey any license under any of its intellectual property rights nor the rights of others. **onsemi** products are not designed, intended, or authorized for use as a critical component in life support systems or any FDA Class 3 medical devices or medical devices with a same or similar classification in a foreign jurisdiction or any devices intended for implantation in the human body. Should Buyer purchase or use **onsemi** products for any such unintended or unauthorized application, Buyer shall indemnify and hold **onsemi** and its officers, employees, subsidiaries, affiliates, and distributors harmless against all claims, costs, damages, and expenses, and reasonable attorney fees arising out of, directly or indirectly, any claim of personal injury or death associated with such unintended or unauthorized use, even if such claim alleges that **onsemi** was negligent regarding the design or manufacture of the part. **onsemi** is an Equal Opportunity/Affirmative Action Employer. This literature is subject to all applicable copyright laws and is not for resale in any manner.

ADDITIONAL INFORMATION

TECHNICAL PUBLICATIONS:

Technical Library: www.onsemi.com/design/resources/technical-documentation
onsemi Website: www.onsemi.com

ONLINE SUPPORT: www.onsemi.com/support

For additional information, please contact your local Sales Representative at www.onsemi.com/support/sales

Looking for pricing, stock, or lifecycle information?

Click below to explore more details on WIN SOURCE:

 [View SZESD7361XV2T1G on WIN SOURCE](#)

 [ON Semiconductor](#) Information

Optimize Your Supply Chain with WIN SOURCE Solutions

-  Global Sourcing Solution
-  Obsolete Management
-  Cost Control Management
-  Shortage Management
-  Alternative Solution
-  Excess Inventory Management