

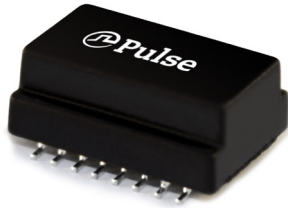





**THE DATASHEET OF
HM1188FNL**





-  Meets AEC-Q200 Requirement
-  Tested with PHY partners
-  Operating Temperature: -40°C to +105°C
-  Member of OPEN alliance

Electrical Specifications 25°C

Part Number	Insertion Loss (dB MAX)		Return Loss (dB MIN)		Cross Talk (dB MIN)		Differential to Common Mode Rejection (dB MIN)
	1 - 100 MHz	100 - 120 MHz	1 - 5 MHz	30 - 80 MHz	1 MHz	5 - 100 MHz	5 - 200 MHz
HM1188FNL	-1.0 dB	-3.0 dB	-18 dB	-16+14.08LOG ₁₀ (f/30 MHz) dB	-62 dB	-45+21 LOG ₁₀ (F/30 MHz) dB	-50+17LOG ₁₀ (f/5) dB

Mechanical

Schematic

HM1188FNL

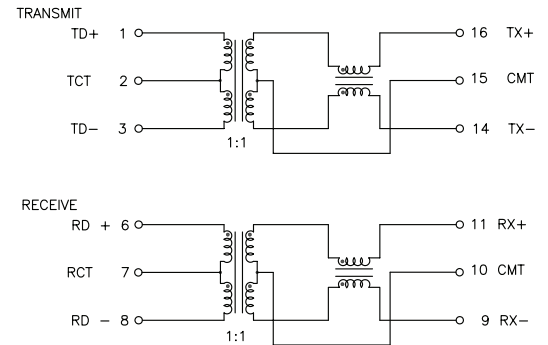
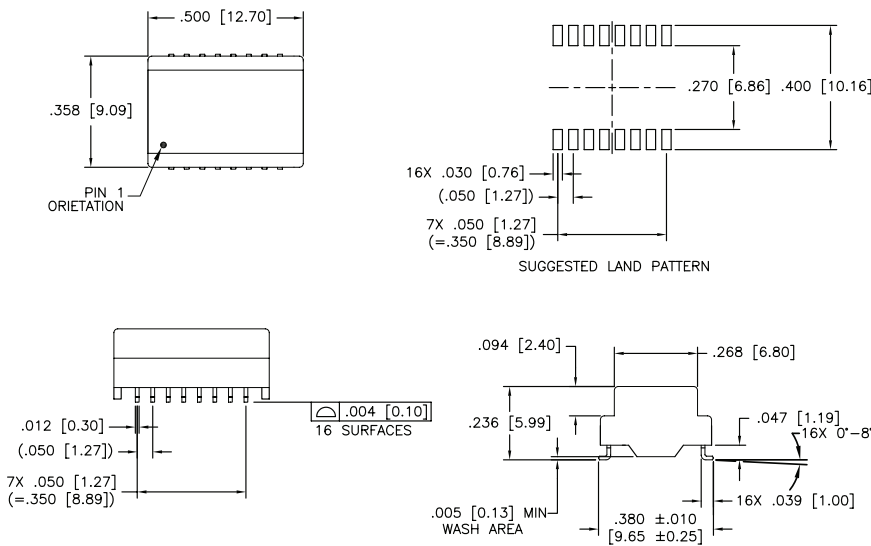

For More Information

Pulse Worldwide Headquarters

12220 World Trade Drive
San Diego, CA 92128
U.S.A.

Tel: 858 674 8100
Fax: 858 674 8262

Pulse Europe

Zeppelinstrasse 15
71083 Herrenberg
Germany

Tel: 49 7032 7806 0
Fax: 49 7032 7806 12

Pulse China Headquarters

B402, Shenzhen Academy of
Aerospace Technology Bldg.
10th Kejian Road
High-Tech Zone
Nanshan District
Shenzhen, PR China 518057

Tel: 86 755 33966678
Fax: 86 755 33966700

Pulse North China

Room 2704/2705
Super Ocean Finance Ctr.
2067 Yan An Road West
Shanghai 200336
China

Tel: 86 21 62787060
Fax: 86 2162786973

Pulse South Asia

135 Joo Seng Road
#03-02
PM Industrial Bldg.
Singapore 368363

Tel: 65 6287 8998
Fax: 65 6287 8998

Pulse North Asia

3F No. 198, Zhongyuan Road
Zhongli City
Taoyuan County (32068)
Taiwan

Tel: 886 3 4356768
Fax: 886 3 4356823

Performance warranty of products offered on this data sheet is limited to the parameters specified. Data is subject to change without notice. Other brand and product names mentioned herein may be trademarks or registered trademarks of their respective owners. © Copyright, 2013. Pulse Electronics, Inc. All rights reserved.

Looking for pricing, stock, or lifecycle information?

Click below to explore more details on WIN SOURCE:

 [View HM1188FNL](#) on WIN SOURCE

 [Pulse Information](#)

Optimize Your Supply Chain with WIN SOURCE Solutions

-  Global Sourcing Solution
-  Obsolete Management
-  Cost Control Management
-  Shortage Management
-  Alternative Solution
-  Excess Inventory Management