



**THE DATASHEET OF  
CDRH4D18CLDNP-330PC**



# SMD Power Inductor CDRH4D18C/LD



## Dimension - [mm]

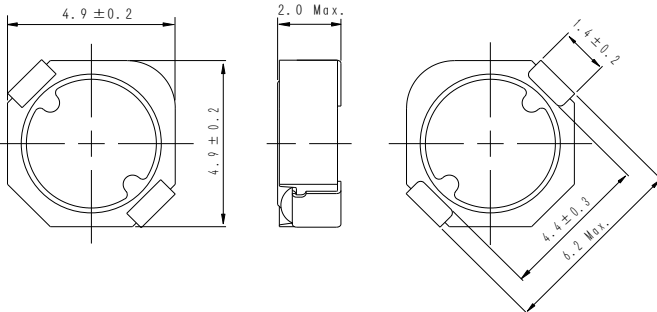

## Land pattern and Schematics - [mm]

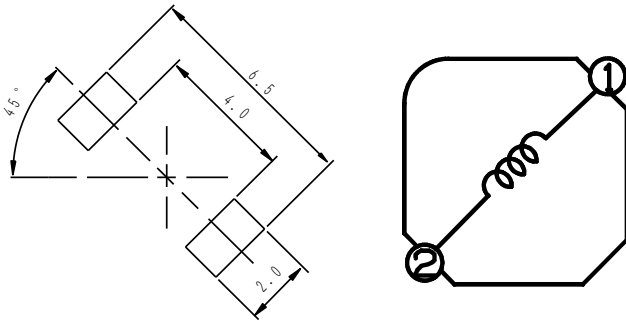

## Description

- Ferrite drum core construction.
- Magnetically shielded.
- L × W × H: 5.1 × 5.1 × 2.0 mm Max.
- Product weight: 135mg(Ref.)
- Moisture Sensitivity Level: 1
- RoHS compliance.

## Environmental Data

- Operating temperature range: -40°C ~ +105°C (including coil's self temperature rise)
- Storage temperature range: -40°C ~ +105°C
- Solder reflow temperature: 260 °C peak.

## Packaging

- Carrier tape and reel packaging
- 7.0" diameter reel
- 1000pcs per reel

## Applications

- Ideally used in Mobile phone, PDA, MP3, HDD, DSC/DVC, Note book PC, etc as DC-DC converter inductors.



### Electrical Characteristics

Part No.	Stamp	Inductance ( $\mu\text{H}$ ) [ within ] ※1	D.C.R. (m $\Omega$ ) Max. (Typ.) (at 20°C)	Saturation Current (A) ※2	Temperature Rise Current (A) ※3
CDRH4D18CLDNP-1R1PC	A	1.1 $\pm$ 25%	24(19)	2.10	3.50
CDRH4D18CLDNP-2R2PC	B	2.2 $\pm$ 25%	31(25)	1.30	2.80
CDRH4D18CLDNP-3R3PC	C	3.3 $\pm$ 25%	49(39)	1.10	2.20
CDRH4D18CLDNP-4R7PC	D	4.7 $\pm$ 25%	61(49)	0.90	2.00
CDRH4D18CLDNP-6R3PC	E	6.3 $\pm$ 25%	74(59)	0.75	1.60
CDRH4D18CLDNP-100PC	F	10 $\pm$ 25%	110(88)	0.60	1.20
CDRH4D18CLDNP-150PC	G	15 $\pm$ 25%	151(121)	0.50	1.05
CDRH4D18CLDNP-220PC	H	22 $\pm$ 25%	202(162)	0.42	0.90
CDRH4D18CLDNP-330PC	I	33 $\pm$ 25%	327(262)	0.35	0.69
CDRH4D18CLDNP-470PC	J	47 $\pm$ 25%	456(365)	0.31	0.57
CDRH4D18CLDNP-680PC	K	68 $\pm$ 25%	632(506)	0.26	0.46
CDRH4D18CLDNP-101PC	L	100 $\pm$ 25%	962(770)	0.20	0.35

※1. Inductance measuring condition: at 100kHz.

※2. Saturation current: The value of D.C. current when the inductance decreases to 65% of it's nominal value.

※3. Temperature rise current: The value of D.C. current when the temperature rise is  $\Delta t=40^\circ\text{C}$  ( $T_a=20^\circ\text{C}$ ).

# SMD Power Inductor CDRH4D18C/LD



## Saturation Current & Temperature Rise Graph

— L (20°C) — L (100°C) —  $\Delta T$

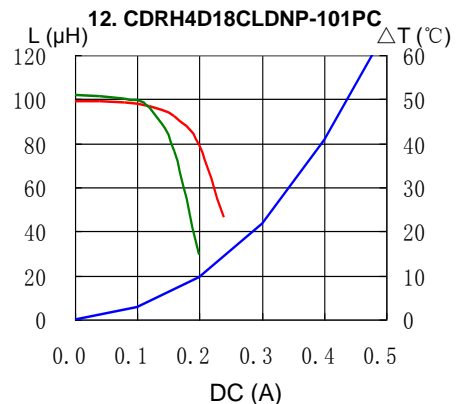
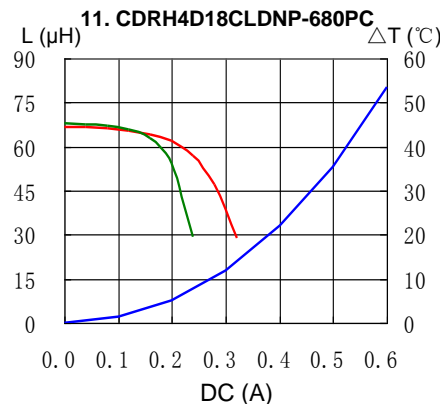
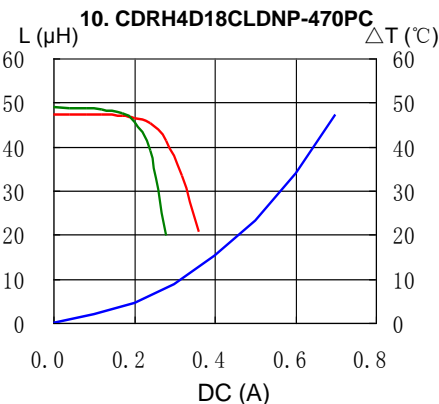
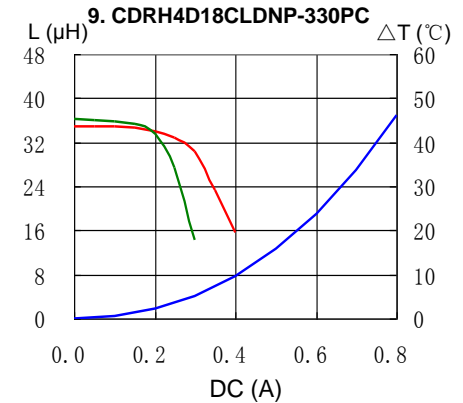
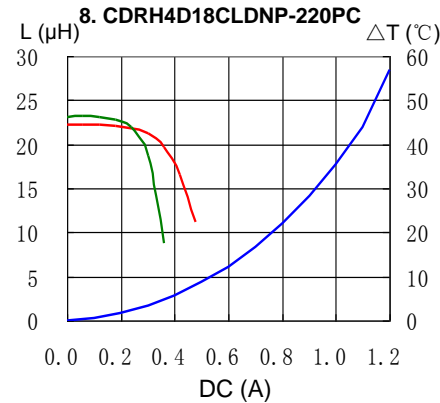
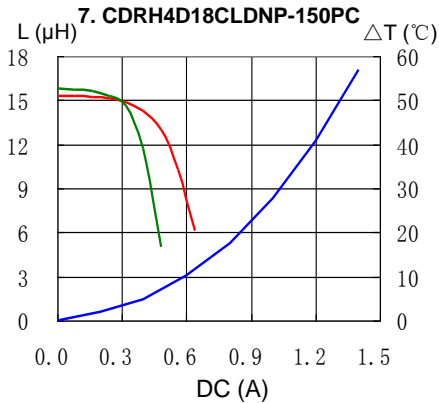
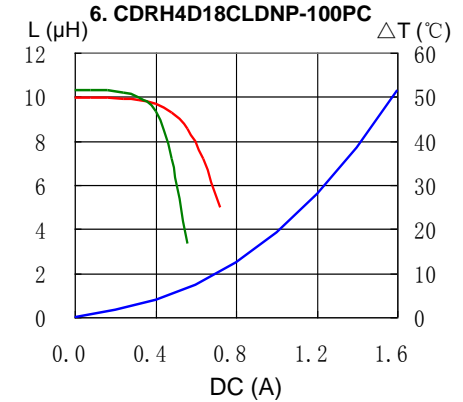
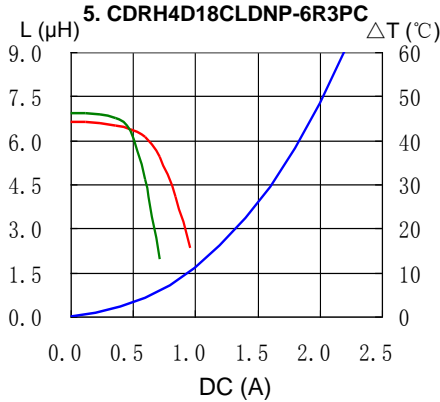
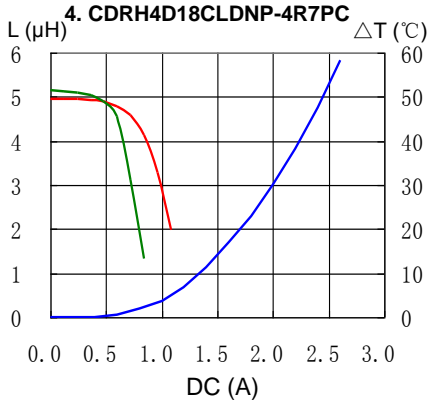
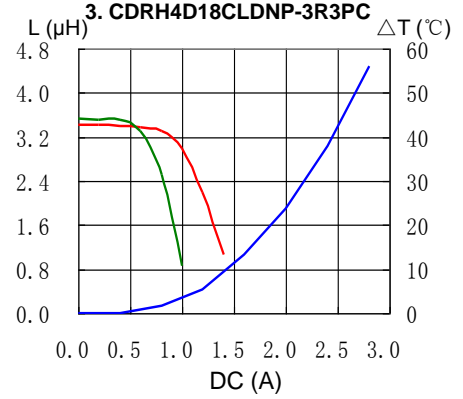
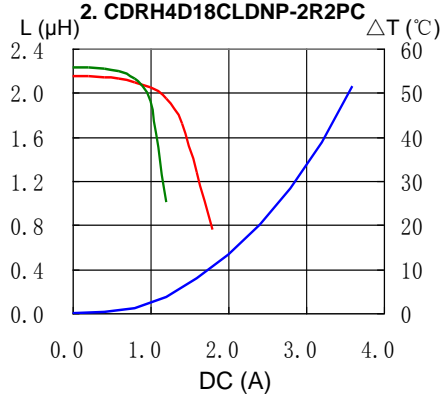
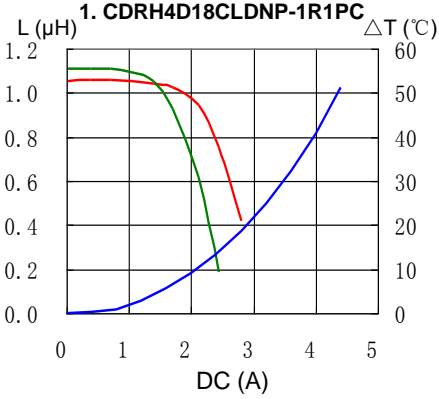

# SMD Power Inductor CDRH4D18C/LD



## Solder Reflow Condition

Heat Endurance

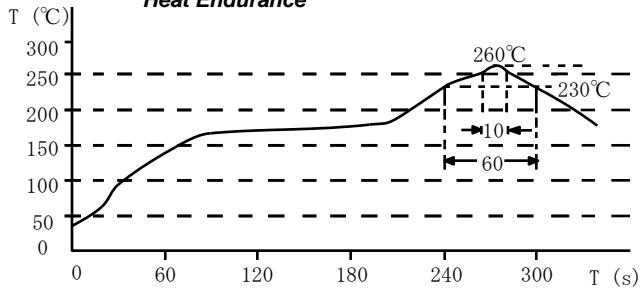

Temperature Chart

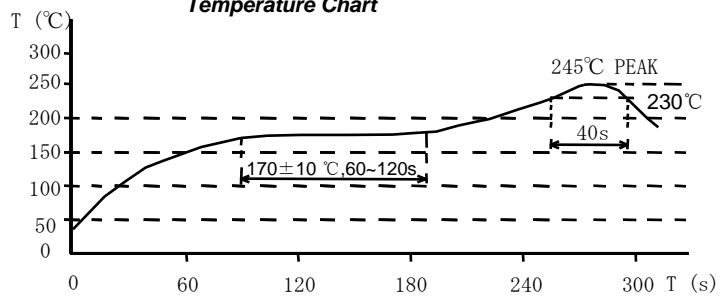

Please refer to the sales offices on our website - <http://www.sumida.com>

### Hong Kong

Tel.+852-2880-6781  
FAX.+852-2565-9600  
[sales@hk.sumida.com](mailto:sales@hk.sumida.com)

### Saitama(Japan)

Tel.+81-48-691-7300  
FAX.+81-48-691-7340  
[sales@jp.sumida.com](mailto:sales@jp.sumida.com)

### Chicago

Tel.+1-847-545-6700  
FAX. +1-847-545-6720  
[sales@us.sumida.com](mailto:sales@us.sumida.com)

### Shanghai

Tel.+86-21-5836-3299  
FAX.+86-21-5836-3266  
[shanghai.sales@cn.sumida.com](mailto:shanghai.sales@cn.sumida.com)

### Seoul

Tel.+82-2-6237-0777  
FAX.+82-2-6237-0778  
[sales@kr.sumida.com](mailto:sales@kr.sumida.com)

### Obernzell

Tel.+49-8591-937-0  
FAX. +49-8591-937-103  
[contact@eu.sumida.com](mailto:contact@eu.sumida.com)

### Shenzhen

Tel.+86-755-8291-0228  
FAX.+86-755-8291-0338  
[shenzhen.sales@cn.sumida.com](mailto:shenzhen.sales@cn.sumida.com)

### Singapore

Tel.+65-6296-3388  
FAX.+65-6841-4426  
[sales@sg.sumida.com](mailto:sales@sg.sumida.com)

### Neumarkt

Tel.+49-9181-4509-110  
FAX. +49-9181-4509-310  
[infocomp@eu.sumida.com](mailto:infocomp@eu.sumida.com)

### Taipei

Tel.+886-2-8751-2737  
FAX.+886-2-8751-2738  
[sales@tw.sumida.com](mailto:sales@tw.sumida.com)

### San Jose

Tel.+1-408-321-9660  
FAX.+1-408-321-9308  
[sales@us.sumida.com](mailto:sales@us.sumida.com)

## Looking for pricing, stock, or lifecycle information?

Click below to explore more details on WIN SOURCE:

- ⊖ [View CDRH4D18CLDNP-330PC on WIN SOURCE](#)
- ⊖ [Sumida America Components Inc. Information](#)

## Optimize Your Supply Chain with WIN SOURCE Solutions

- ✓ Global Sourcing Solution
- ✓ Obsolete Management
- ✓ Cost Control Management
- ✓ Shortage Management
- ✓ Alternative Solution
- ✓ Excess Inventory Management