



THE DATASHEET OF CBP12-C



A. System Overview

Circuit Board Posts

B1. Cable Ties

- For board-to-board or board-to-chassis mounting
- Bell flange on bottom end provides greater stability
- Releasable and reusable

- Material: Nylon 6.6
- Color: Natural

B2. Cable Accessories



B3. Stainless Steel Ties

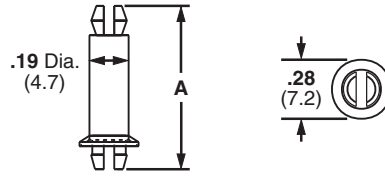

Part Number	Standoff Height		Height A		Panel Hole Diameter		Mounting Method	Std. Pkg. Qty.	Std. Ctn. Qty.
	In.	mm	In.	mm	In.	mm			
CBP12-C	.12	3.0	.40	10.2	.156	3.96	Push Barb	100	500
CBP25-C	.25	6.4	.54	13.5	.156	3.96		100	500
CBP31-C	.31	7.9	.59	15.0	.156	3.96		100	500
CBP37-C	.37	9.4	.62	15.7	.156	3.96		100	500
CBP50-C	.50	12.7	.78	19.8	.156	3.96		100	500
CBP62-C	.62	15.7	.91	23.0	.156	3.96		100	500
CBP75-C	.75	19.1	1.04	26.2	.156	3.96		100	500
CBP87-C	.87	22.1	1.15	29.2	.156	3.96		100	500
CBP100-C	1.00	25.4	1.28	32.5	.156	3.96		100	500

C1. Wiring Duct

C2. Surface Raceway

C3. Abrasion Protection

C4. Cable Management

D1. Terminals

Circuit Board Locking Supports

D2. Power Connectors

- For board-to-chassis support
- Snap-in design for fast assembly
- Design of wing provides added stability

- Releasable and reusable
- Material: Nylon 6.6

D3. Grounding Connectors



E1. Labeling Systems

E2. Labels

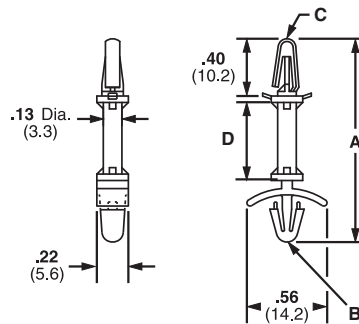

Part Number	Height A		Panel Hole Diameter B		Chassis Panel Hole Diameter C		Standoff Height D		Color	Mounting Method	Std. Pkg. Qty.	Std. Ctn. Qty.
	In.	mm	In.	mm	In.	mm	In.	mm				
CBLS18-C	.92	23.4	.19	4.8	.16	4.0	.19	4.7	Natural	Push Barb	100	500
CBLS25-C	.98	24.9	.19	4.8	.16	4.0	.25	6.4			100	500
CBLS37-C	1.11	28.2	.19	4.8	.16	4.0	.38	9.5			100	500
CBLS50-C	1.23	31.2	.19	4.8	.16	4.0	.50	12.7			100	500
CBLS62-C	1.35	34.3	.19	4.8	.16	4.0	.63	15.9			100	500
CBLS75-C	1.48	37.5	.19	4.8	.16	4.0	.75	19.1			100	500

E3. Pre-Printed & Write-On Markers

E4. Permanent Identification

E5. Lockout/Tagout & Safety Solutions

F. Index

Looking for pricing, stock, or lifecycle information?

Click below to explore more details on WIN SOURCE:

 [View CBP12-C on WIN SOURCE](#)

 [Panduit Corp](#) Information

Optimize Your Supply Chain with WIN SOURCE Solutions

-  Global Sourcing Solution
-  Obsolete Management
-  Cost Control Management
-  Shortage Management
-  Alternative Solution
-  Excess Inventory Management