

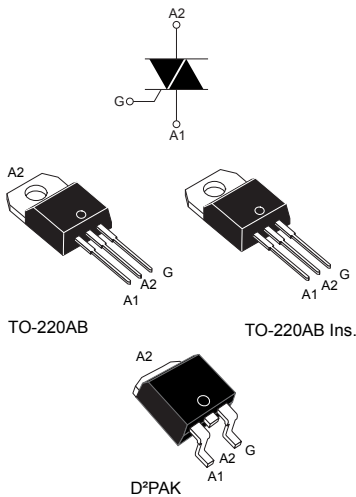

**THE DATASHEET OF
BTB16-600CWRG**



Snubberless™, logic level and standard 16 A Triacs



Features

- Medium current Triac
- Low thermal resistance with clip bonding
- Low thermal resistance insulation ceramic for insulated BTA
- High commutation (4Q) or very high commutation (3Q, Snubberless™) capability
- BTA series UL1557 certified (file ref: 81734)
- Packages are RoHS (2002/95/EC) compliant
- Insulated tab (BTA series, rated at 2500 V_{RMS})

Applications

- Snubberless versions (BTA/BTB...W and T1635) especially recommended for use on inductive loads, because of their high commutation performances
- On/off or phase angle function in applications such as static relays, light dimmers and appliance motor speed controllers

Description

Available either in through-hole or surface mount packages, the BTA16, BTB16 and T1610, T1635 and T1650 Triac series are suitable for general purpose mains power AC switching. They can be used as ON/OFF function in applications such as static relays, heating regulation or induction motor starting circuit. They are also recommended for phase control operations in light dimmers and appliance motors speed controllers.

The Snubberless™ versions (W suffix and T1610, T1635, T1650) are especially recommended for use on inductive loads, because of their high commutation performance.

By using an internal ceramic pad, the Snubberless™ series provide an insulated tab (rated at 2500 V_{RMS}) complying with UL standards (file reference: E81734).

| Product status link | |
|--|-----------------------|
| | BTA16 |
| | BTB16 |
| | T1610 |
| | T1635 |
| | T1650 |
| Product summary | |
| I_{T(RMS)} | 16 A |
| V_{DRM}/V_{RSM} | 600, 800 V |
| I_{GT}Snubberless™ | 10, 35, 50 mA |
| I_{GT}standard | 25, 50 mA |

1 Characteristics

Table 1. Absolute maximum ratings

| Symbol | Parameters | Value | Unit | |
|-------------------|---|--|-------------------------|------------------|
| $I_{T(RMS)}$ | RMS on-state current (full sine wave) | TO-220AB, D ² PAK $T_c = 100\text{ °C}$ | 16 | A |
| | | TO-220AB Ins. $T_c = 86\text{ °C}$ | | |
| I_{TSM} | Non repetitive surge peak on-state current (full cycle, T_j initial = 25 °C) | F = 50 Hz $t_p = 20\text{ ms}$ | 160 | A |
| | | F = 60 Hz $t_p = 16.7\text{ ms}$ | 168 | |
| I^2t | I^2t value for fusing | $t_p = 10\text{ ms}$ | 144 | A ² s |
| di/dt | Critical rate of rise of on-state current $I_G = 2 \times I_{GT}$, $t_r \leq 100\text{ ns}$ | F = 120 Hz $T_j = 125\text{ °C}$ | 50 | A/ μ s |
| V_{DSM}/V_{RSM} | Non repetitive surge peak off-state voltage | $t_p = 10\text{ ms}$ $T_j = 25\text{ °C}$ | $V_{DRM}/V_{RRM} + 100$ | V |
| I_{GM} | Peak gate current | $t_p = 20\text{ }\mu$ s $T_j = 125\text{ °C}$ | 4 | A |
| $P_{G(AV)}$ | Average gate power dissipation | $T_j = 125\text{ °C}$ | 1 | W |
| T_{stg} | Storage junction temperature range | | -40 to +150 | °C |
| T_j | Operating junction temperature range | | -40 to +125 | °C |

Table 2. Static electrical characteristics

| Symbol | Test conditions | T_j | | Value | Unit |
|-------------------|---|--------|------|-------|------------|
| $V_T^{(1)}$ | $I_{TM} = 22.5\text{ A}$, $t_p = 380\text{ }\mu$ s | 25 °C | Max. | 1.55 | V |
| $V_{TO}^{(1)}$ | threshold on-state voltage | 125 °C | Max. | 0.85 | V |
| $R_D^{(1)}$ | Dynamic resistance | 125 °C | Max. | 25 | m Ω |
| I_{DRM}/I_{RRM} | $V_{DRM} = V_{RRM}$ | 25 °C | Max. | 5 | μ A |
| | | 125 °C | | 2 | mA |

1. For both polarities of A2 referenced to A1

Table 3. Electrical characteristics ($T_j = 25\text{ °C}$, unless otherwise specified) - standard (4 quadrants)

| Symbol | Parameters | Quadrant | | BTA16 BTB16 | | Unit |
|----------------|--|--------------|------|----------------|-----|------|
| | | | | C | B | |
| $I_{GT}^{(1)}$ | $V_D = 12\text{ V}$, $R_L = 33\text{ }\Omega$ | I - II - III | Max. | 25 | 50 | mA |
| | | IV | | 50 | 100 | |
| V_{GT} | | All | Max. | 1.3 | | V |
| V_{GD} | $V_D = V_{DRM}$, $R_L = 3.3\text{ k}\Omega$, $T_j = 125\text{ °C}$ | All | Min. | 0.2 | | V |
| $I_H^{(2)}$ | $I_T = 500\text{ mA}$ | | Max. | 25 | 50 | mA |
| I_L | $I_G = 1.2 I_{GT}$ | I - III - IV | Max. | 40 | 60 | mA |
| | | II | Max. | 80 | 120 | |

| Symbol | Parameters | Quadrant | | BTA16 BTB16 | | Unit |
|-------------------|---|----------|------|----------------|-----|------------|
| | | | | C | B | |
| $dV/dt^{(2)}$ | $V_D = 67\% V_{DRM}$ gate open, $T_j = 125\text{ °C}$ | | Min. | 200 | 400 | V/ μ s |
| $(dI/dt)_c^{(2)}$ | $(dI/dt)_c = 7\text{ A/ms}$, $T_j = 125\text{ °C}$ | | Min. | 5 | 10 | V/ μ s |

1. Minimum I_{GT} is guaranteed at 5 % of I_{GT} max.
2. For both polarities of A2 referenced to A1

Table 4. Electrical characteristics ($T_j = 25\text{ °C}$, unless otherwise specified) - Snubberless and logic level (3 quadrants)

| Symbol | Parameters | Quadrant | | T1610 / BTA16- SW / BTB16- SW | T1635 / BTA16-CW / BTB16-CW | T1650 / BTA16-BW / BTB16-BW | Unit |
|-------------------|--|--------------|------|-------------------------------------|-----------------------------------|-----------------------------------|------------|
| $I_{GT}^{(1)}$ | $V_D = 12\text{ V}$, $R_L = 30\ \Omega$ | I - II - III | Max. | 10 | 35 | 50 | mA |
| V_{GT} | | | Max. | 1.3 | | | V |
| V_{GD} | $V_D = V_{DRM}$, $R_L = 3,3\text{ k}\Omega$, $T_j = 125\text{ °C}$ | | Min. | 0.2 | | | V |
| $I_H^{(2)}$ | $I_T = 500\text{ mA}$ | | Max. | 15 | 35 | 50 | mA |
| I_L | $I_G = 1.2 I_{GT}$ | I - III | Max. | 25 | 50 | 70 | mA |
| | | II | Max. | 30 | 60 | 80 | |
| $(dV/dt)^{(2)}$ | $V_D = 67\% V_{DRM}$ gate open, $T_j = 125\text{ °C}$ | | Min. | 40 | 500 | 1000 | V/ μ s |
| $(dI/dt)_c^{(2)}$ | $(dV/dt)_c = 0.1\text{ V}/\mu\text{s}$, $T_j = 125\text{ °C}$ | | | 8.5 | | | A/ms |
| | $(dV/dt)_c = 10\text{ V}/\mu\text{s}$, $T_j = 125\text{ °C}$ | | Min. | 3.0 | | | |
| | Without snubber, $T_j = 125\text{ °C}$ | | | | 8.5 | 14 | |

1. Minimum I_{GT} is guaranteed at 5 % of I_{GT} max.
2. For both polarities of A2 referenced to A1

Table 5. Thermal resistance

| Symbol | Parameters | Value | Unit |
|---------------|--|-------------------------------|------|
| $R_{th(j-c)}$ | Max. junction to case (AC) | TO-220AB / D ² PAK | 1.2 |
| | | TO-220AB insulated | 2.1 |
| $R_{th(j-a)}$ | Junction to ambient (S = 2 cm ²) | D ² PAK | 45 |
| | Junction to ambient | TO-220AB / TO-220AB ins | 60 |

1. Copper surface under tab.

1.1 Characteristics (curves)

Figure 2. Maximum power dissipation versus on-state RMS current (full cycle)

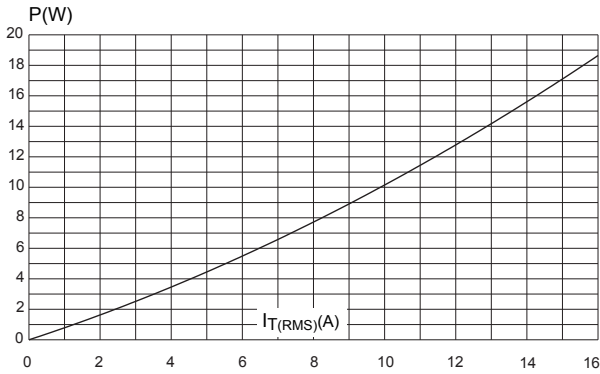

Figure 3. RMS on-state current versus case temperature (full cycle)

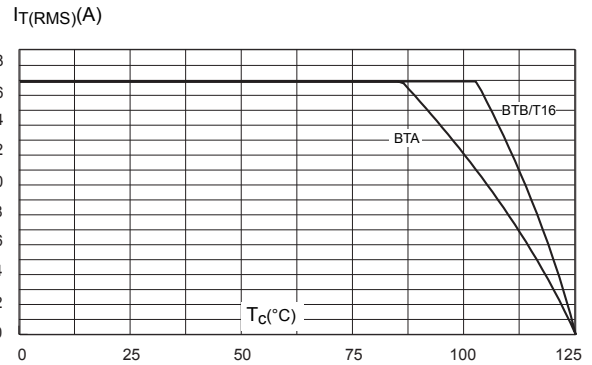

Figure 4. On-state rms current versus ambient temperature (full cycle)

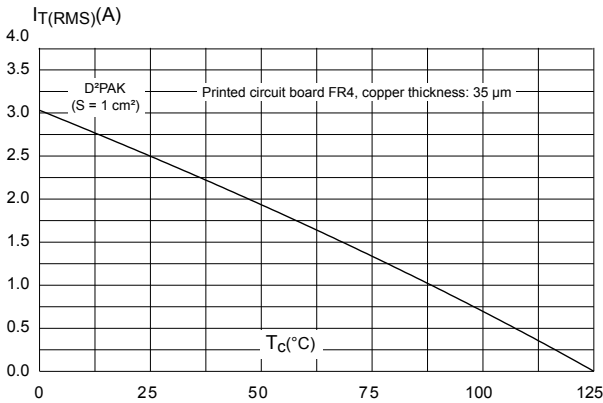

Figure 5. Relative variation of thermal impedance versus pulse duration

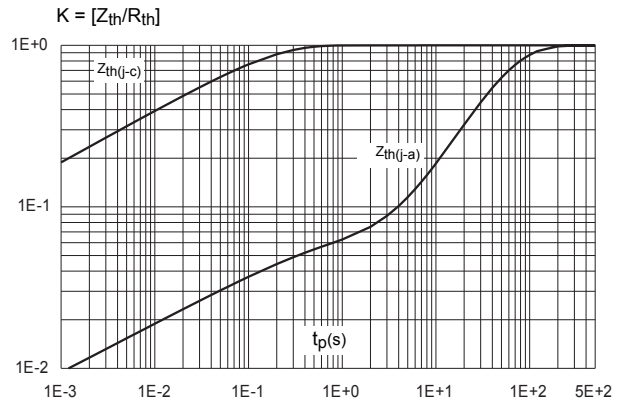

Figure 6. On-state characteristics (maximum values)

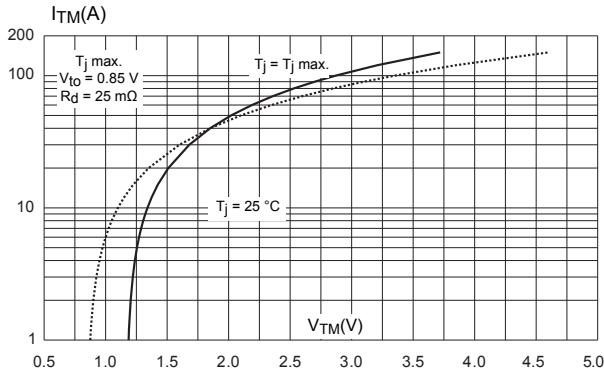

Figure 7. Surge peak on-state current versus number of cycles

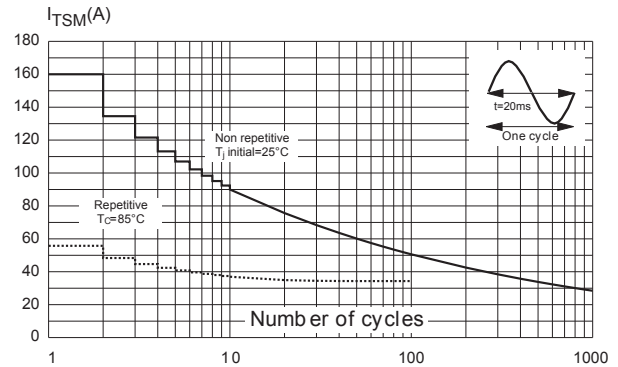

Figure 8. Non-repetitive surge peak on-state current for a sinusoidal

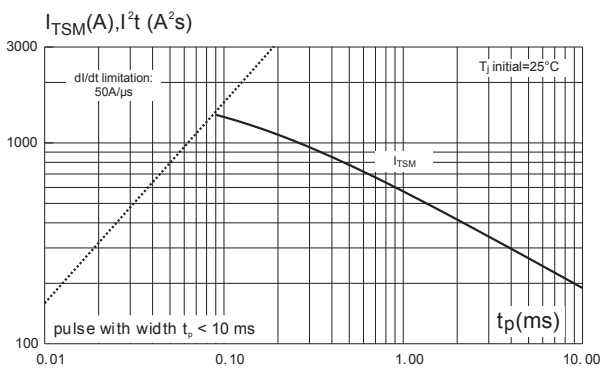

Figure 9. Relative variation of gate trigger current

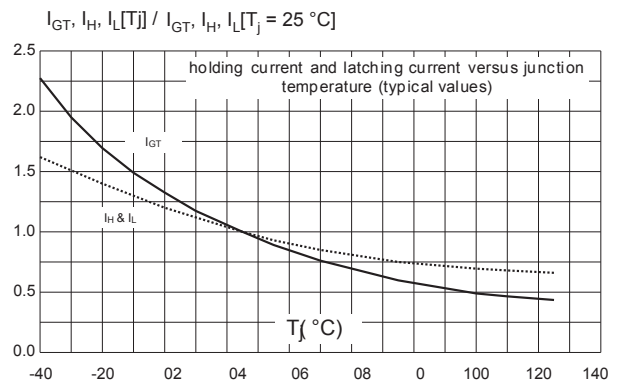

Figure 10. Relative variation of critical rate of decrease of main current versus (dV/dt)c (typical values)

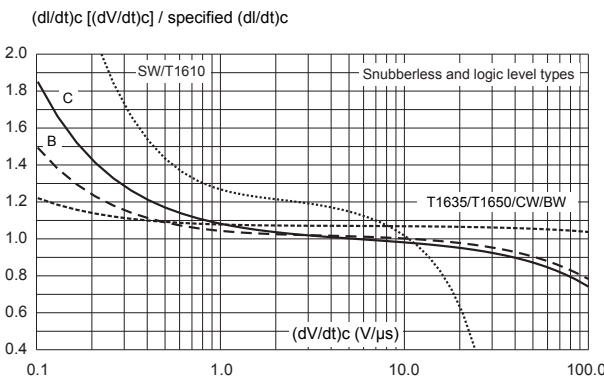

Figure 11. Relative variation of critical rate of decrease of main current versus (junction temperature (typical values)

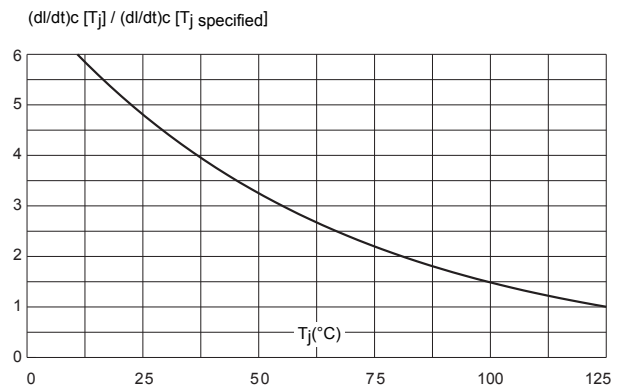
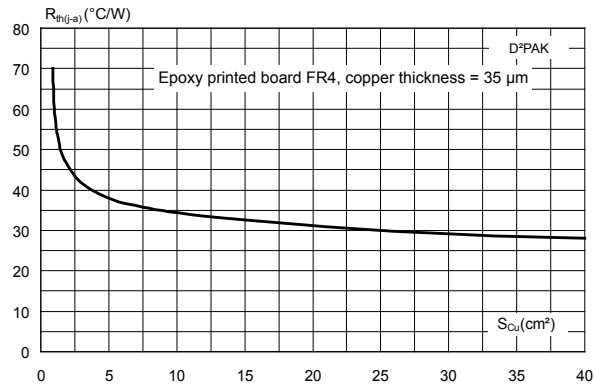

Figure 12. D²PAK thermal resistance junction to ambient versus copper surface under tab



2 Package information

In order to meet environmental requirements, ST offers these devices in different grades of ECOPACK® packages, depending on their level of environmental compliance. ECOPACK® specifications, grade definitions and product status are available at: www.st.com. ECOPACK® is an ST trademark.

2.1 TO-220AB Insulated and non Insulated package information

- Epoxy meets UL 94, V0
- Cooling method: by conduction (C)
- Recommended torque value: 0.55 N·m
- Maximum torque value: 0.70 N·m

Figure 13. TO-220AB Insulated and non Insulated package outline

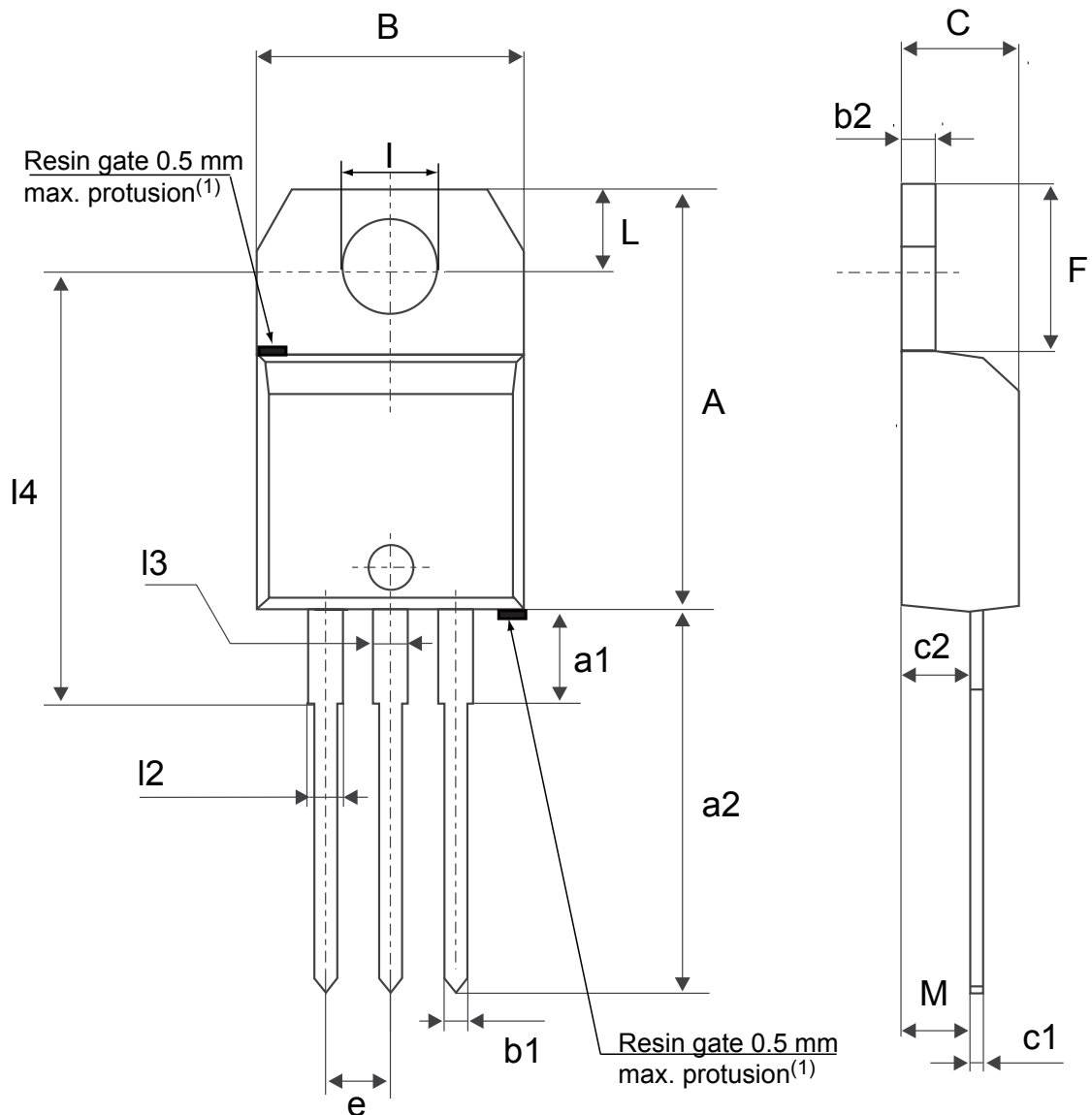

(1) Resin gate position accepted in one of the two positions or in the symmetrical opposites.

Table 6. TO-220AB Insulated and non Insulated package mechanical data

| Ref. | Dimensions | | | | | |
|------|-------------|-------|-------|--------|--------|--------|
| | Millimeters | | | Inches | | |
| | Min. | Typ. | Max. | Min. | Typ. | Max. |
| A | 15.20 | | 15.90 | 0.5984 | | 0.6260 |
| a1 | | 3.75 | | | 0.1476 | |
| a2 | 13.00 | | 14.00 | 0.5118 | | 0.5512 |
| B | 10.00 | | 10.40 | 0.3937 | | 0.4094 |
| b1 | 0.61 | | 0.88 | 0.0240 | | 0.0346 |
| b2 | 1.23 | | 1.32 | 0.0484 | | 0.0520 |
| C | 4.40 | | 4.60 | 0.1732 | | 0.1811 |
| c1 | 0.49 | | 0.70 | 0.0193 | | 0.0276 |
| c2 | 2.40 | | 2.72 | 0.0945 | | 0.1071 |
| e | 2.40 | | 2.70 | 0.0945 | | 0.1063 |
| F | 6.20 | | 6.60 | 0.2441 | | 0.2598 |
| I | 3.73 | | 3.88 | 0.1469 | | 0.1528 |
| L | 2.65 | | 2.95 | 0.1043 | | 0.1161 |
| I2 | 1.14 | | 1.70 | 0.0449 | | 0.0669 |
| I3 | 1.14 | | 1.70 | 0.0449 | | 0.0669 |
| I4 | 15.80 | 16.40 | 16.80 | 0.6220 | 0.6457 | 0.6614 |
| M | | 2.6 | | | 0.1024 | |

1. Inch dimensions are for reference only.

2.2 D²PAK package information

Figure 14. D²PAK package outline

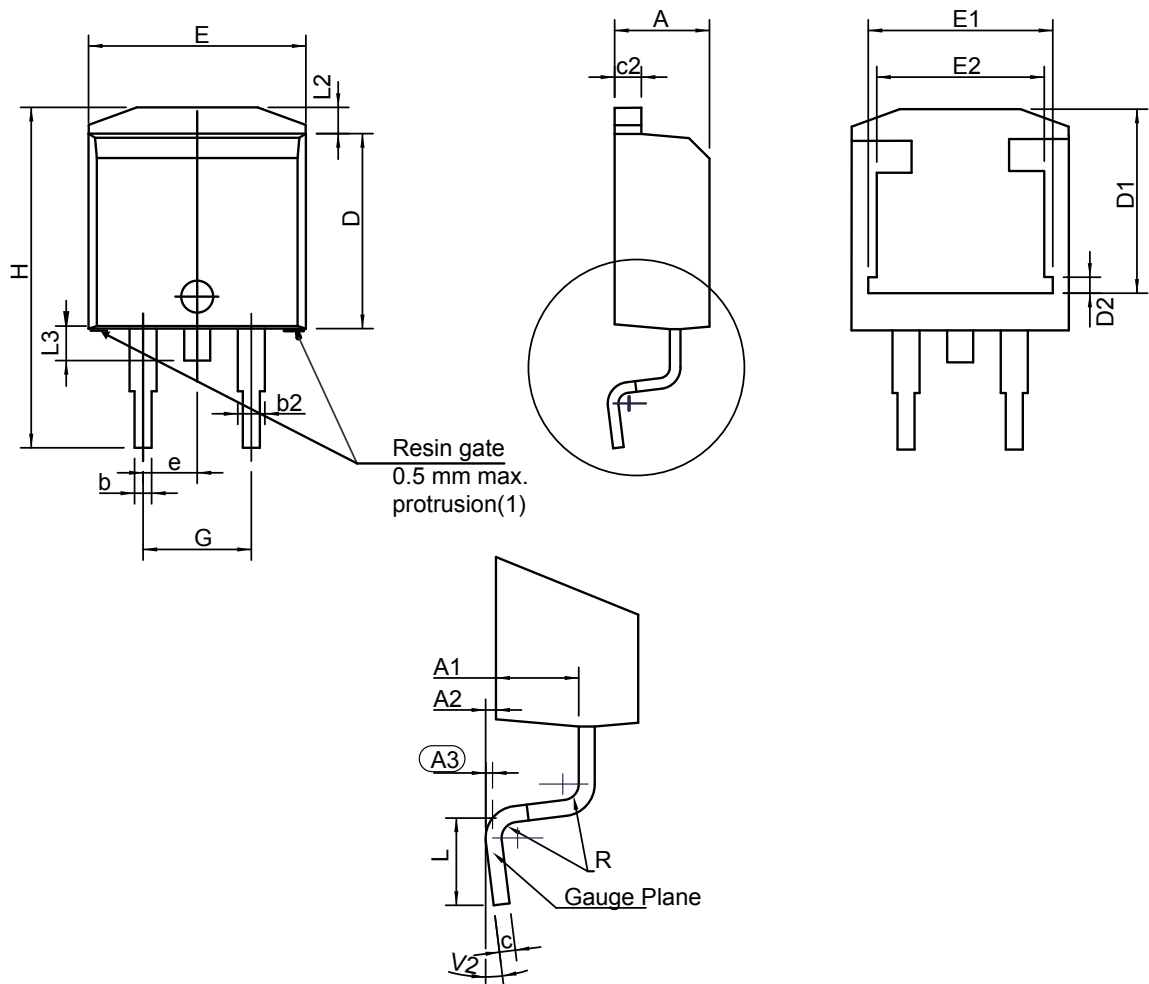

(1) Resin gate position accepted in one of the two positions or in the symmetrical opposites

Table 7. D²PAK package mechanical data

| Ref. | Dimensions | | | | | |
|------|-------------|------|-------|--------|--------|--------|
| | Millimeters | | | Inches | | |
| | Min. | Typ. | Max. | Min. | Typ. | Max. |
| A | 4.30 | | 4.60 | 0.1693 | | 0.1811 |
| A1 | 2.49 | | 2.69 | 0.0980 | | 0.1059 |
| A2 | 0.03 | | 0.23 | 0.0012 | | 0.0091 |
| A3 | | 0.25 | | | 0.0098 | |
| b | 0.70 | | 0.93 | 0.0276 | | 0.0366 |
| b2 | 1.25 | | 1.7 | 0.0492 | | 0.0669 |
| c | 0.45 | | 0.60 | 0.0177 | | 0.0236 |
| c2 | 1.21 | | 1.36 | 0.0476 | | 0.0535 |
| D | 8.95 | | 9.35 | 0.3524 | | 0.3681 |
| D1 | 7.50 | | 8.00 | 0.2953 | | 0.3150 |
| D2 | 1.30 | | 1.70 | 0.0512 | | 0.0669 |
| e | 2.54 | | | 0.1 | | |
| E | 10.00 | | 10.28 | 0.3937 | | 0.4047 |
| E1 | 8.30 | | 8.70 | 0.3268 | | 0.3425 |
| E2 | 6.85 | | 7.25 | 0.2697 | | 0.2854 |
| G | 4.88 | | 5.28 | 0.1921 | | 0.2079 |
| H | 15 | | 15.85 | 0.5906 | | 0.6240 |
| L | 1.78 | | 2.28 | 0.0701 | | 0.0898 |
| L2 | 1.27 | | 1.40 | 0.0500 | | 0.0551 |
| L3 | 1.40 | | 1.75 | 0.0551 | | 0.0689 |
| R | | 0.40 | | | 0.0157 | |
| V2 | 0° | | 8° | 0° | | 8° |

1. Dimensions in inches are given for reference only

Figure 15. D²PAK recommended footprint (dimensions are in mm)

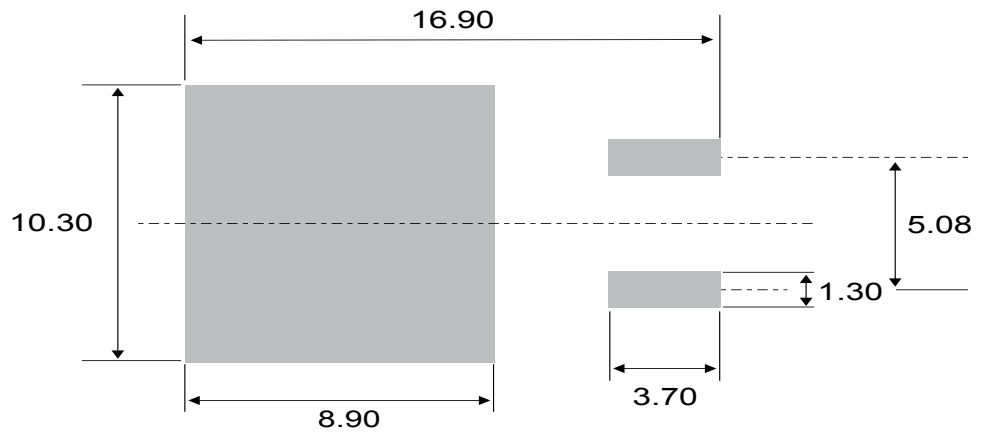

3 Ordering information

Figure 16. Ordering information scheme (BTA16 and BTB16 series)

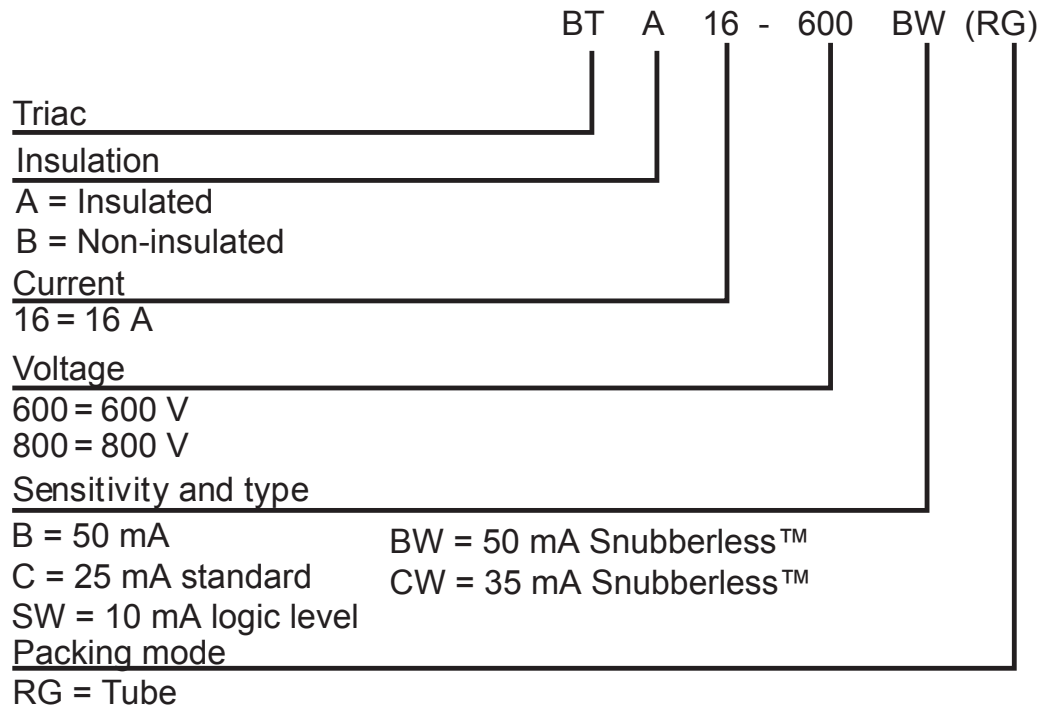
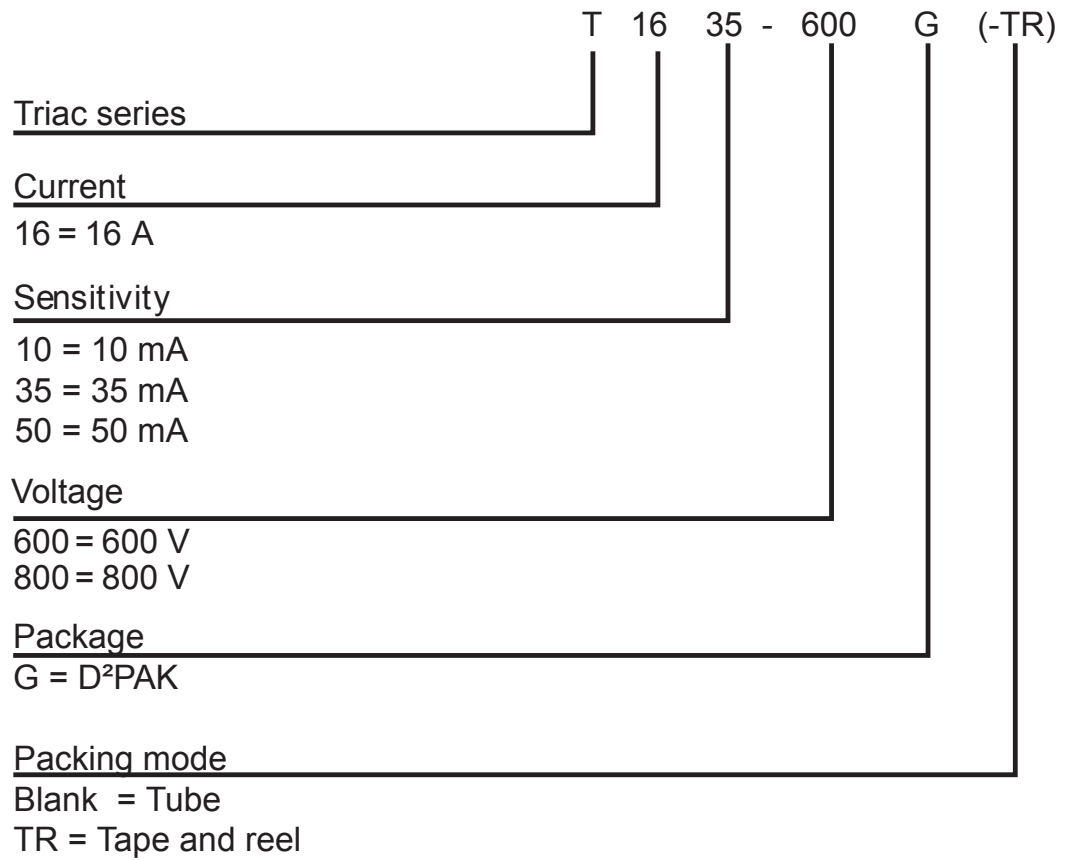

Figure 17. Ordering information scheme (T8 series)



3.1 Product selector

Table 8. Product selector

| Part Number | | Sensitivity | Type | Package |
|-------------|-------------|-------------|--------------|--------------------|
| 600 | 800 | | | |
| BTB16-600C | | 35 mA | Standard | TO-220AB |
| BTB16-600B | BTB16-800B | 50 mA | Standard | TO-220AB |
| BTB16-600SW | BTB16-800SW | 10 mA | Snubberless™ | TO-220AB |
| BTB16-600CW | BTB16-800CW | 35 mA | Snubberless™ | TO-220AB |
| BTB16-600BW | BTB16-800BW | 50 mA | Snubberless™ | TO-220AB |
| BTA16-600C | | 35 mA | Standard | TO-220AB Ins. |
| BTA16-600B | BTA16-800B | 50 mA | Standard | TO-220AB Ins. |
| BTA16-600SW | BTA16-800SW | 10 mA | Snubberless™ | TO-220AB Ins. |
| BTA16-600CW | BTA16-800CW | 35 mA | Snubberless™ | TO-220AB Ins. |
| BTA16-600BW | BTA16-800BW | 50 mA | Snubberless™ | TO-220AB Ins. |
| T1610-600G | T1610-800G | 10 mA | Snubberless™ | D ² PAK |
| T1635-600G | T1635-800G | 35 mA | Snubberless™ | D ² PAK |
| T1650-600G | | 50 mA | Snubberless™ | D ² PAK |

3.2 Ordering information

Table 9. Ordering information

| Order code | Marking | Package | Weight | Base qty. | Delivery mode |
|---------------|-------------|--------------------|--------|-----------|---------------|
| BTA16-600BRG | BTA16-600B | TO-220AB Ins. | 2.30 | 50 | Tube |
| BTA16-600BWRG | BTA16-600BW | | | | |
| BTA16-600CRG | BTA16-600C | | | | |
| BTA16-600CWRG | BTA16-600CW | | | | |
| BTA16-600SWRG | BTA16-600SW | | | | |
| BTA16-800BRG | BTA16-800B | | | | |
| BTA16-800BWRG | BTA16-800BW | | | | |
| BTA16-800CWRG | BTA16-800CW | | | | |
| BTA16-800SWRG | BTA16-800SW | | | | |
| BTB16-600BRG | BTB16-600B | TO-220AB | | | Tube |
| BTB16-600BWRG | BTB16-600BW | | | | |
| BTB16-600CRG | BTB16-600C | | | | |
| BTB16-600CWRG | BTB16-600CW | | | | |
| BTB16-600SWRG | BTB16-600SW | | | | |
| BTB16-800BRG | BTB16-800B | | | | |
| BTB16-800BWRG | BTB16-800BW | | | | |
| BTB16-800CWRG | BTB16-800CW | | | | |
| BTB16-800SWRG | BTB16-800SW | | | | |
| T1610-600G-TR | T1610-600G | D ² PAK | 1.50 | 1000 | Tape and reel |
| T1610-800G-TR | T1610-800G | | | | |
| T1635-600G-TR | T1635-600G | | | | |
| T1635-800G-TR | T1635-800G | | | | |
| T1650-600G-TR | T1650-600G | | | | |
| T1635-600G | T1635-600G | | | 50 | Tube |

Revision history

Table 10. Document revision history

| Date | Revision | Changes |
|-------------|----------|---|
| Oct-2002 | 6A | Last update. |
| 13-Feb-2006 | 7 | TO-220AB delivery mode changed from bulk to tube. ECOPACK statement added. |
| 03-Jul-2009 | 8 | Added part number T1610. |
| 04-Dec-2009 | 9 | Updated value for V_{DSM} / V_{RSM} in Table 2. Updated temperature in Table 2 from 15 °C to 86 °C. |
| 11-Mar-2010 | 10 | Updated value for V_{DSM} / V_{RSM} in Table 2. Updated temperature in Table 2 from 15 °C to 86 °C. |
| 30-May-2018 | 11 | Updated Section • Product status / summary . Added T1650 package information. |

IMPORTANT NOTICE – PLEASE READ CAREFULLY

STMicroelectronics NV and its subsidiaries (“ST”) reserve the right to make changes, corrections, enhancements, modifications, and improvements to ST products and/or to this document at any time without notice. Purchasers should obtain the latest relevant information on ST products before placing orders. ST products are sold pursuant to ST’s terms and conditions of sale in place at the time of order acknowledgement.

Purchasers are solely responsible for the choice, selection, and use of ST products and ST assumes no liability for application assistance or the design of Purchasers’ products.

No license, express or implied, to any intellectual property right is granted by ST herein.

Resale of ST products with provisions different from the information set forth herein shall void any warranty granted by ST for such product.



ST and the ST logo are trademarks of ST. All other product or service names are the property of their respective owners.

Information in this document supersedes and replaces information previously supplied in any prior versions of this document.

© 2018 STMicroelectronics – All rights reserved

Looking for pricing, stock, or lifecycle information?

Click below to explore more details on WIN SOURCE:

-  [View BTB16-600CWGRG on WIN SOURCE](#)
-  [STMicroelectronics Information](#)

Optimize Your Supply Chain with WIN SOURCE Solutions

-  Global Sourcing Solution
-  Obsolete Management
-  Cost Control Management
-  Shortage Management
-  Alternative Solution
-  Excess Inventory Management