

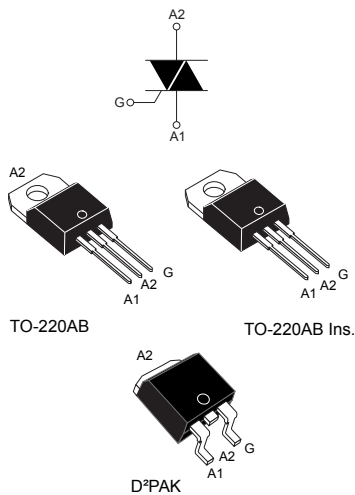

**THE DATASHEET OF
BTB12-600SWRG**



12 A Snubberless™, logic level and standard Triacs



Features

- Medium current Triac
- Low thermal resistance with clip bonding
- Low thermal resistance insulation ceramic for insulated BTA
- High commutation (4Q) or very high commutation (3Q) capability
- BTA series UL1557 certified (file ref: 81734)
- Packages are RoHS (2011/65/EU) compliant

Description

Available either in through-hole or surface mount packages, the BTA12, BTB12 and T12xx Triac series are suitable for general purpose mains power AC switching. They can be used as ON/OFF function in applications such as static relays, heating regulation or induction motor starting circuit. They are also recommended for phase control operations in light dimmers and appliance motors speed controllers.

The Snubberless™ versions (W suffix and T12xx) are especially recommended for use on inductive loads, because of their high commutation performance. By using an internal ceramic pad, the Snubberless™ series provide an insulated tab (rated at 2500 V_{RMS}) complying with UL standards (file reference: E81734).

Logic Level BTA12-600TW and BTA12-600SW offer low holding current, ideal to design light dimmers for LED lamps.

Product status link

[BTA12](#)

[BTB12](#)

[T1205](#)

[T1210](#)

[T1235](#)

[T1250](#)

Product summary

| | |
|-----------------------|---------------------|
| $I_{T(RMS)}$ | 12 A |
| V_{DRM}/V_{RRM} | 600 and 800 V |
| $I_{GT(Snubberless)}$ | 5 / 10 / 35 / 50 mA |
| $I_{GT(standard)}$ | 25 / 50 |

1 Characteristics

Table 1. Absolute maximum ratings ($T_j = 25\text{ °C}$ unless otherwise stated)

| Symbol | Parameter | | | Value | Unit |
|-------------------|--|------------------------------|------------------------|------------------------------|------------------|
| $I_{T(RMS)}$ | RMS on-state current (full sine wave) | TO-220AB, D ² PAK | $T_c = 105\text{ °C}$ | 12 | A |
| | | TO-220AB Ins. | $T_c = 90\text{ °C}$ | | |
| I_{TSM} | Non repetitive surge peak on-state current (full cycle, T_j initial = 25 °C) | f = 50 Hz | t = 20 ms | 120 | A |
| | | f = 60 Hz | $t_p = 16.7\text{ ms}$ | 126 | |
| I^2t | I^2t value for fusing | | $t_p = 10\text{ ms}$ | 78 | A ² s |
| dI/dt | Critical rate of rise of on-state current $I_G = 2 \times I_{GT}$, tr ≤ 100 ns | f = 120 Hz | $T_j = 125\text{ °C}$ | 50 | A/μs |
| V_{DSM}/V_{RSM} | Non repetitive surge peak off-state voltage | $t_p = 10\text{ ms}$ | $T_j = 25\text{ °C}$ | V_{DRM} / V_{RRM}^+ 100 | V |
| I_{GM} | Peak gate current | $t_p = 20\text{ μs}$ | $T_j = 125\text{ °C}$ | 4 | A |
| $P_{G(AV)}$ | Average gate power dissipation | | $T_j = 125\text{ °C}$ | 1 | W |
| T_{stg} | Storage junction temperature range | | | -40 to +150 | °C |
| T_j | Operating junction temperature range | | | -40 to +125 | °C |

Table 2. Electrical characteristics ($T_j = 25\text{ °C}$, unless otherwise specified) - Snubberless™ and logic level (3 quadrants)

| Symbol | Parameter | Quadrant | | T1205 | T1210 | T1235 | T1250 | Unit |
|-------------------------------------|---|--------------|------|----------------------|----------------------|----------------------|----------------------|------|
| | | | | BTB12-TW BTA12-TW | BTB12-SW BTA12-SW | BTB12-CW BTA12-CW | BTB12-BW BTA12-BW | |
| $I_{GT}^{(1)}$ | $V_D = 12\text{ V}$, $R_L = 30\text{ Ω}$ | I - II - III | Max. | 5 | 10 | 35 | 50 | mA |
| V_{GT} | | I - II - III | Max. | 1.3 | | | | V |
| V_{GD} | $V_D = V_{DRM}$, $R_L = 3.3\text{ kΩ}$, $T_j = 125\text{ °C}$ | I - II - III | Min. | 0.2 | | | | V |
| $I_H^{(2)}$ | $I_T = 100\text{ mA}$ | I - II - III | Max. | 10 | 15 | 35 | 50 | mA |
| $I_L^{(2)}$ | $I_G = 1.2 \times I_{GT}$ | I - III | Max. | 10 | 25 | 50 | 70 | mA |
| | | II | Max. | 15 | 30 | 60 | 80 | |
| dV/dt ⁽²⁾ | $V_D = 67\% V_{DRM}$, gate open, $T_j = 125\text{ °C}$ | | Max. | 20 | 40 | 500 | 1000 | V/μs |
| (dI/dt) _c ⁽²⁾ | (dV/dt) _c = 0.1 V/μs, $T_j = 125\text{ °C}$ | | Min. | 3.5 | 6.5 | | | A/ms |
| | (dV/dt) _c = 10 V/μs, $T_j = 125\text{ °C}$ | | Min. | 1.0 | 2.9 | | | |
| | Without snubber, $T_j = 125\text{ °C}$ | | Min. | | | 6.5 | 12 | |

1. Minimum I_{GT} is guaranteed at 5 % of I_{GT} max.
2. For both polarities of A2 referenced to A1

Table 3. Electrical characteristics ($T_j = 25\text{ }^\circ\text{C}$, unless otherwise specified) - Standard Triac (4 quadrants)

| Symbol | Parameter | Quadrant | | Value | | Unit |
|-------------------|---|--------------|------|-------|-----|------------------|
| | | | | C | B | |
| $I_{GT}^{(1)}$ | $V_D = 12\text{ V}$, $R_L = 30\ \Omega$ | I - II - III | Max. | 25 | 50 | mA |
| | | IV | | 50 | 100 | |
| V_{GT} | | All | Max. | 1.3 | | V |
| V_{GD} | $V_D = V_{DRM}$, $R_L = 33\text{ k}\Omega$, $T_j = 125\text{ }^\circ\text{C}$ | All | Min. | 0.2 | | V |
| $I_H^{(2)}$ | $I_T = 500\text{ mA}$ | I - II - III | Max. | 25 | 50 | mA |
| I_L | $I_G = 1.2 I_{GT}$ | I - III - IV | Max. | 40 | 50 | mA |
| | | II | | 80 | 100 | |
| $dV/dt^{(2)}$ | $V_D = 67\%$ V_{DRM} gate open, $T_j = 125\text{ }^\circ\text{C}$ | | Min. | 200 | 400 | V/ μs |
| $(dV/dt)_C^{(2)}$ | $(dI/dt)_C = 5.3\text{ A/ms}$, $T_j = 125\text{ }^\circ\text{C}$ | | Min. | 5 | 10 | V/ μs |

1. Minimum I_{GT} is guaranteed at 5 % of I_{GT} max.
2. For both polarities of A2 referenced to A1

Table 4. Static electrical characteristics

| Symbol | Test conditions | | | Value | Unit |
|---------------------|---|-----------------------------------|------|-------|---------------|
| $V_{TM}^{(1)}$ | $I_{TM} = 17\text{ A}$, $t_p = 380\ \mu\text{s}$ | $T_j = 25\text{ }^\circ\text{C}$ | Max. | 1.55 | V |
| $V_{TO}^{(1)}$ | threshold on-state voltage | $T_j = 125\text{ }^\circ\text{C}$ | Max. | 0.85 | V |
| $R_D^{(1)}$ | Dynamic resistance | $T_j = 125\text{ }^\circ\text{C}$ | Max. | 35 | m Ω |
| I_{DRM} I_{RRM} | $V_{DRM} = V_{RRM}$ | $T_j = 25\text{ }^\circ\text{C}$ | Max. | 5 | μA |
| | | $T_j = 125\text{ }^\circ\text{C}$ | Max. | 1 | mA |

1. For both polarities of A2 referenced to A1

Table 5. Thermal resistance

| Symbol | Parameter | | | Value | Unit | |
|---------------|---|------------------------------------|-------------------------------|-------|------|--------------------|
| $R_{th(j-c)}$ | Max. junction to case thermal resistance (AC) | | D ² PAK / TO-220AB | Max. | 1.4 | $^\circ\text{C/W}$ |
| | | | TO-220AB insulated | Max. | 2.3 | |
| $R_{th(j-a)}$ | Junction to ambient | $S = 2\text{ cm}^2$ ⁽¹⁾ | D ² PAK | Typ. | 45 | $^\circ\text{C/W}$ |
| | Junction to ambient | | TO-220AB / TO-220AB insulated | Typ. | 60 | |

1. S = Copper surface under tab.

1.1 Characteristics (curves)

Figure 1. Maximum power dissipation versus on-state RMS current (full cycle)

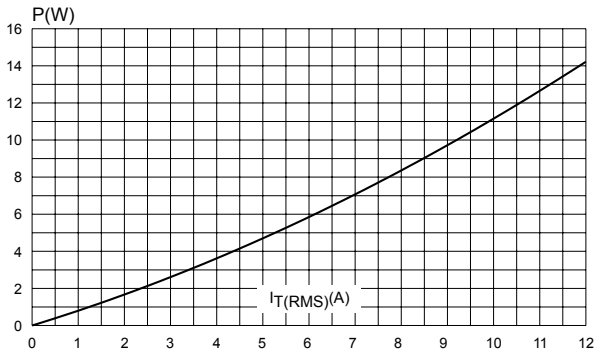

Figure 2. RMS on-state current cycle versus case temperature (full cycle)

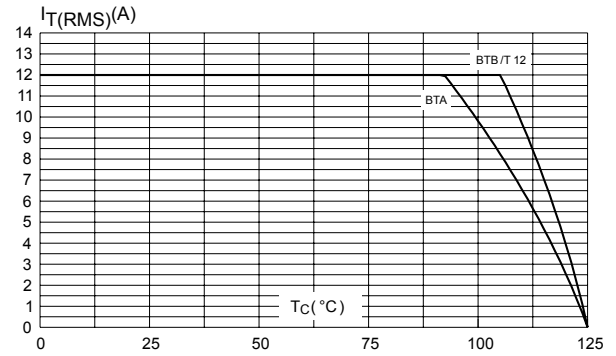

Figure 3. RMS on-state current versus ambient temperature (printed circuit board FR4, copper thickness: 35 μm) (full cycle)

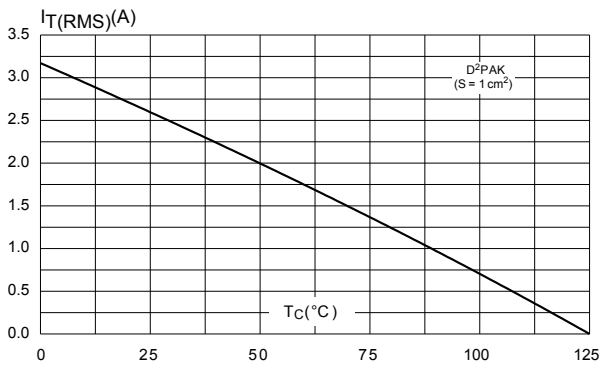

Figure 4. Relative variation of thermal impedance versus pulse duration

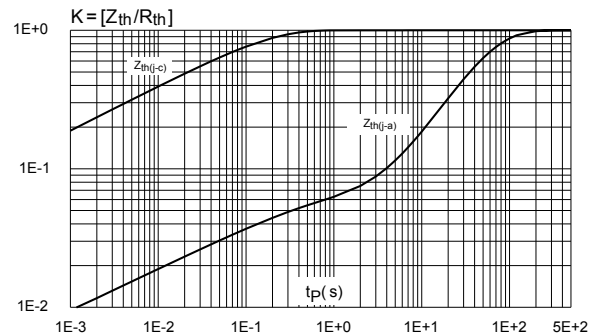

Figure 5. On-state characteristics (maximum values)

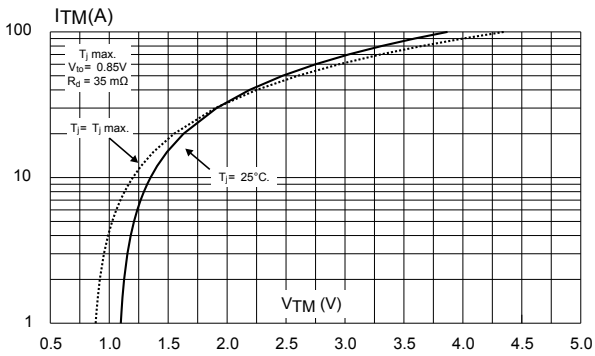

Figure 6. Surge peak on-state current versus number of cycles

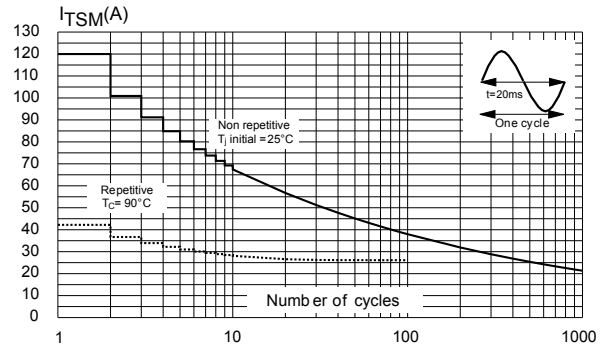

Figure 7. Non repetitive surge peak on-state current for a sinusoidal pulse

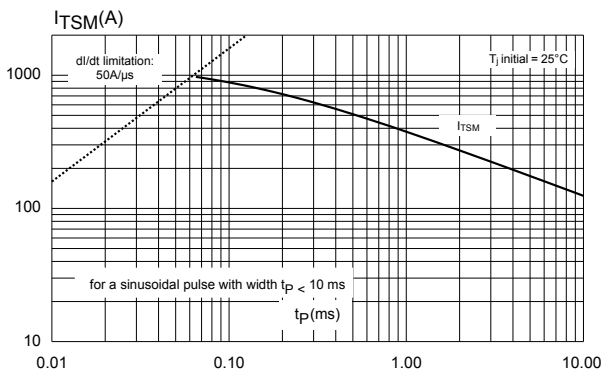

Figure 8. Relative variation of gate trigger current holding current and latching current versus junction temperature (typical values)

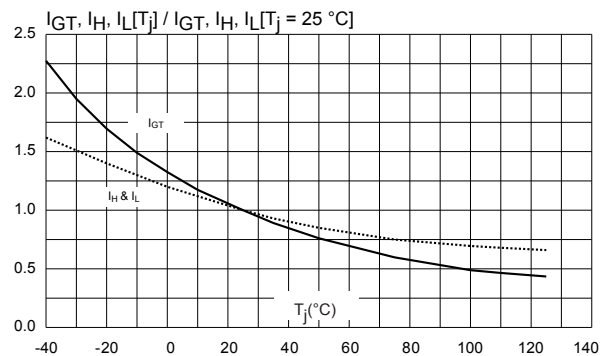

Figure 9. Relative variation of critical rate of decrease of main current versus (dV/dt)_c (typical values)

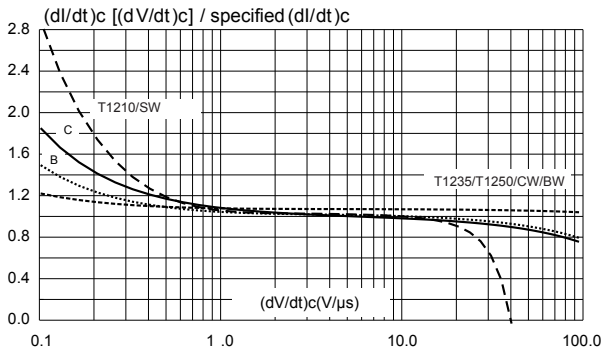

Figure 10. Relative variation of critical rate of decrease of main current versus (dV/dt)_c (typical values)(TW)

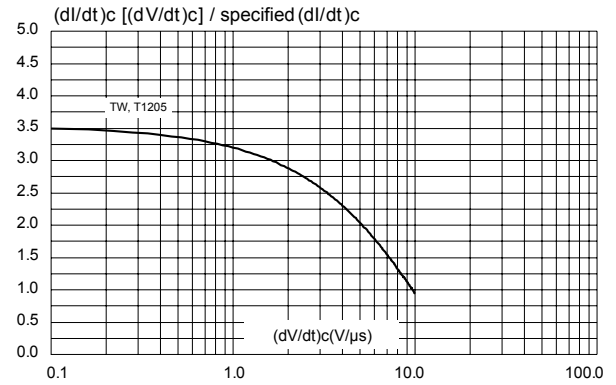

Figure 11. Relative variation of critical rate of decrease of main current versus junction temperature

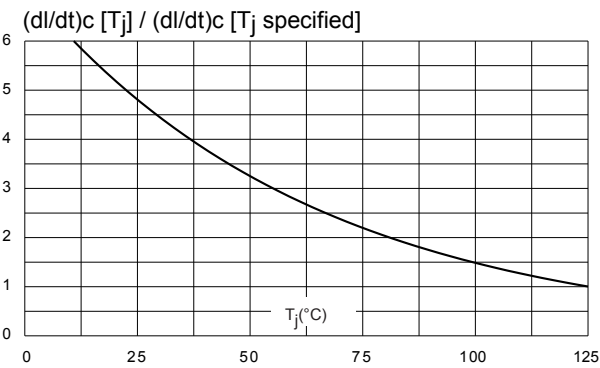
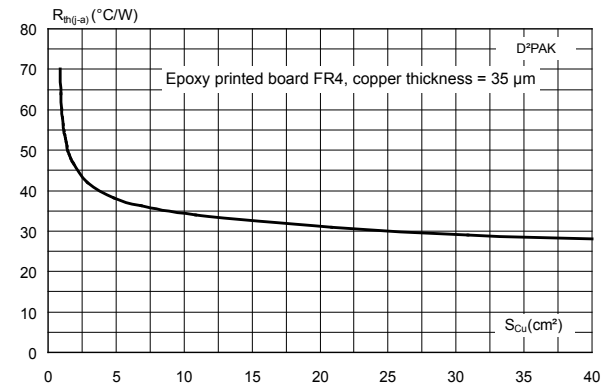

Figure 12. D²PAK thermal resistance junction to ambient versus copper surface under tab



2 Package information

In order to meet environmental requirements, ST offers these devices in different grades of **ECOPACK®** packages, depending on their level of environmental compliance. ECOPACK® specifications, grade definitions and product status are available at: www.st.com. ECOPACK® is an ST trademark.

2.1 D²PAK package information

- ECOPACK2® compliant
- Lead-free package leads finishing
- Molding compound resin is halogen-free and meets UL standard level V0

Figure 13. D²PAK package outline

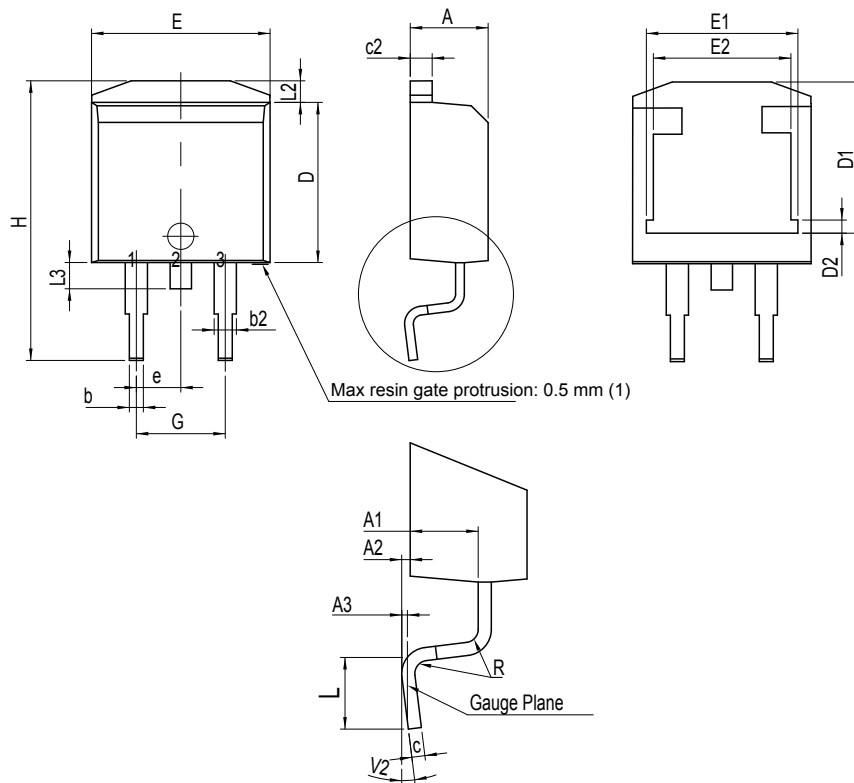

(1) Resin gate is accepted in each of position shown on the drawing, or their symmetrical.

Table 6. D²PAK package mechanical data

| Ref. | Dimensions | | | | | |
|------|-------------|------|-------|-----------------------|--------|--------|
| | Millimeters | | | Inches ⁽¹⁾ | | |
| | Min. | Typ. | Max. | Min. | Typ. | Max. |
| A | 4.30 | | 4.60 | 0.1693 | | 0.1811 |
| A1 | 2.49 | | 2.69 | 0.0980 | | 0.1059 |
| A2 | 0.03 | | 0.23 | 0.0012 | | 0.0091 |
| A3 | | 0.25 | | | 0.0098 | |
| b | 0.70 | | 0.93 | 0.0276 | | 0.0366 |
| b2 | 1.25 | | 1.7 | 0.0492 | | 0.0669 |
| c | 0.45 | | 0.60 | 0.0177 | | 0.0236 |
| c2 | 1.21 | | 1.36 | 0.0476 | | 0.0535 |
| D | 8.95 | | 9.35 | 0.3524 | | 0.3681 |
| D1 | 7.50 | | 8.00 | 0.2953 | | 0.3150 |
| D2 | 1.30 | | 1.70 | 0.0512 | | 0.0669 |
| e | 2.54 | | | 0.1 | | |
| E | 10.00 | | 10.28 | 0.3937 | | 0.4047 |
| E1 | 8.30 | | 8.70 | 0.3268 | | 0.3425 |
| E2 | 6.85 | | 7.25 | 0.2697 | | 0.2854 |
| G | 4.88 | | 5.28 | 0.1921 | | 0.2079 |
| H | 15 | | 15.85 | 0.5906 | | 0.6240 |
| L | 1.78 | | 2.28 | 0.0701 | | 0.0898 |
| L2 | 1.27 | | 1.40 | 0.0500 | | 0.0551 |
| L3 | 1.40 | | 1.75 | 0.0551 | | 0.0689 |
| R | | 0.40 | | | 0.0157 | |
| V2 | 0° | | 8° | 0° | | 8° |

1. Dimensions in inches are given for reference only

Figure 14. D²PAK recommended footprint (dimensions are in mm)

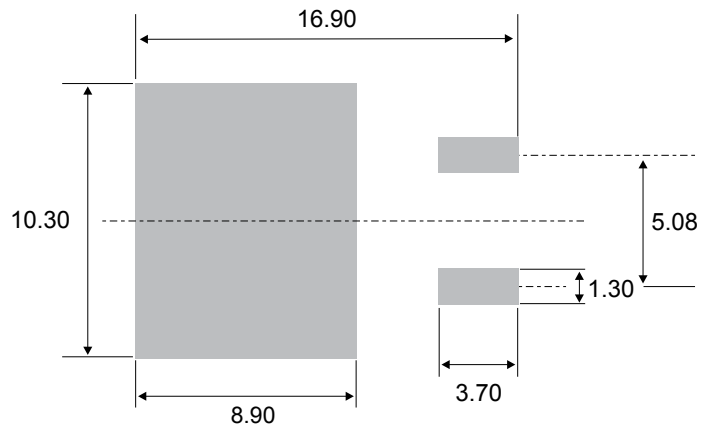

2.2 TO-220AB insulated package information

- Epoxy meets UL 94,V0
- Cooling method: by conduction (C)
- Recommended torque value: 0.55 N·m
- Maximum torque value: 0.70 N·m

Figure 15. TO-220AB insulated and non insulated package outline

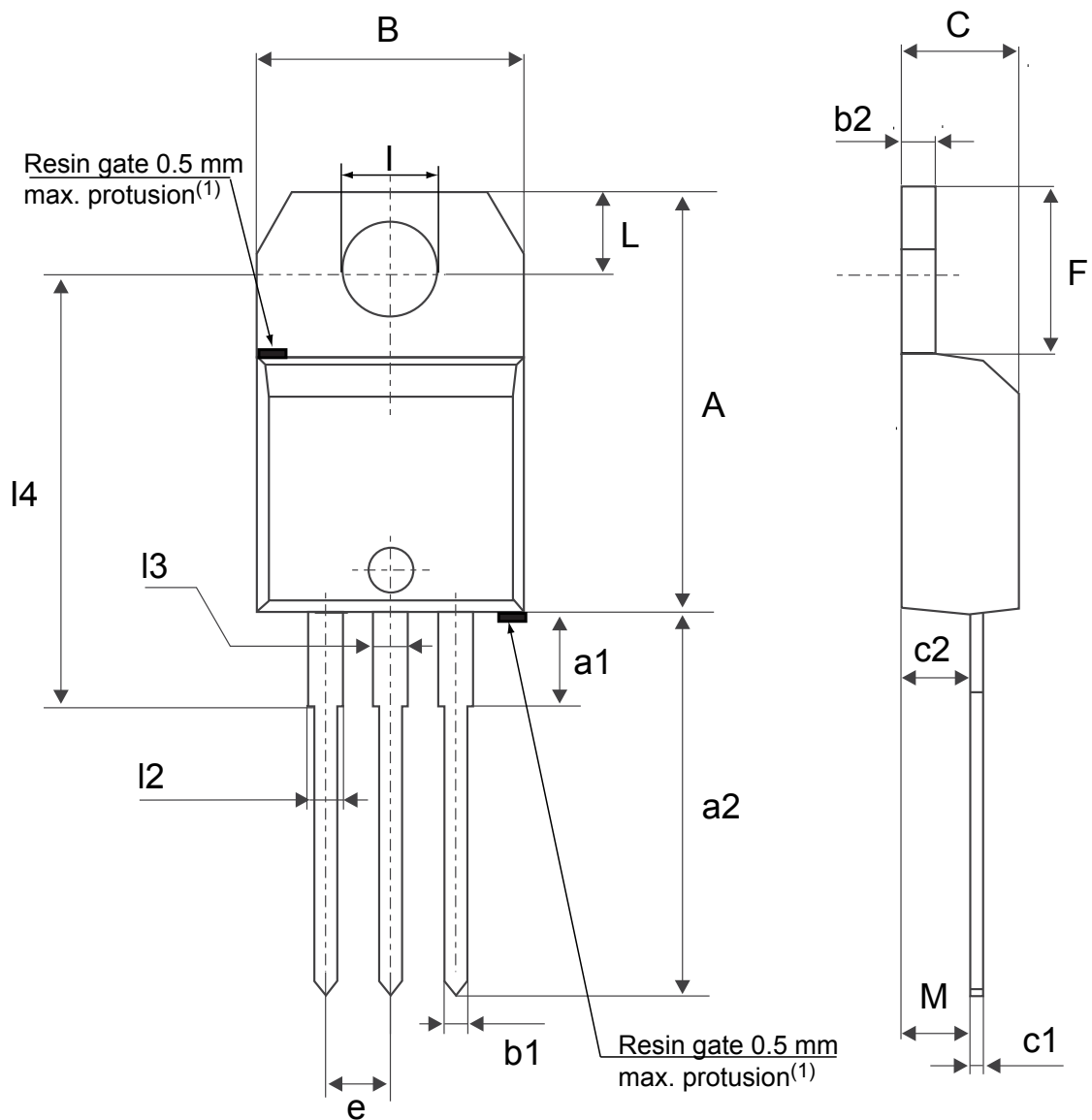

(1) Resin gate position accepted in one of the two positions or in the symmetrical opposites.

Table 7. TO-220AB insulated and non insulated package mechanical data

| Ref. | Dimensions | | | | | |
|------|-------------|-------|-------|-----------------------|--------|--------|
| | Millimeters | | | Inches ⁽¹⁾ | | |
| | Min. | Typ. | Max. | Min. | Typ. | Max. |
| A | 15.20 | | 15.90 | 0.5984 | | 0.6260 |
| a1 | | 3.75 | | | 0.1476 | |
| a2 | 13.00 | | 14.00 | 0.5118 | | 0.5512 |
| B | 10.00 | | 10.40 | 0.3937 | | 0.4094 |
| b1 | 0.61 | | 0.88 | 0.0240 | | 0.0346 |
| b2 | 1.23 | | 1.32 | 0.0484 | | 0.0520 |
| C | 4.40 | | 4.60 | 0.1732 | | 0.1811 |
| c1 | 0.49 | | 0.70 | 0.0193 | | 0.0276 |
| c2 | 2.40 | | 2.72 | 0.0945 | | 0.1071 |
| e | 2.40 | | 2.70 | 0.0945 | | 0.1063 |
| F | 6.20 | | 6.60 | 0.2441 | | 0.2598 |
| l | 3.73 | | 3.88 | 0.1469 | | 0.1528 |
| L | 2.65 | | 2.95 | 0.1043 | | 0.1161 |
| l2 | 1.14 | | 1.70 | 0.0449 | | 0.0669 |
| l3 | 1.14 | | 1.70 | 0.0449 | | 0.0669 |
| l4 | 15.80 | 16.40 | 16.80 | 0.6220 | 0.6457 | 0.6614 |
| M | | 2.6 | | | 0.1024 | |

1. Inch dimensions are for reference only.

3 Ordering information

Figure 16. Ordering information scheme (BTA12 and BTB12 series)

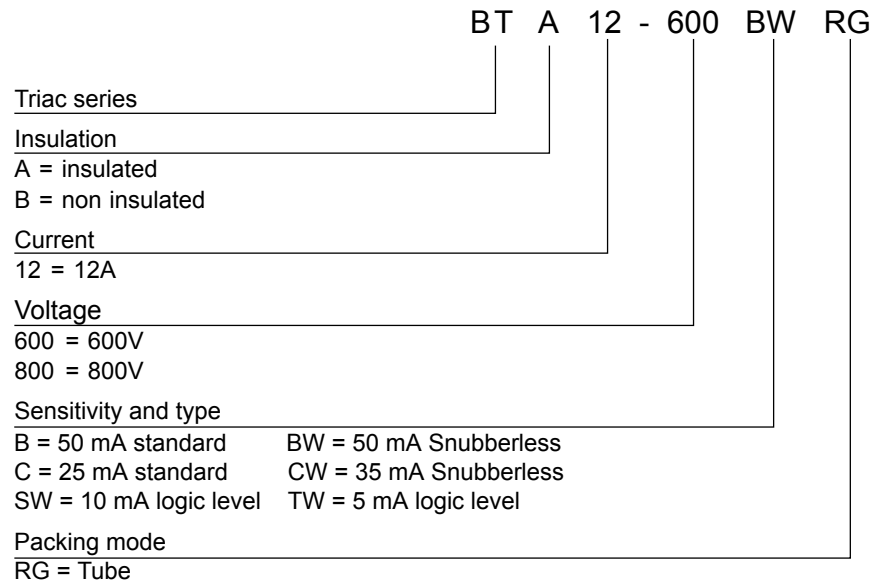

Figure 17. Ordering information scheme (T12 series)

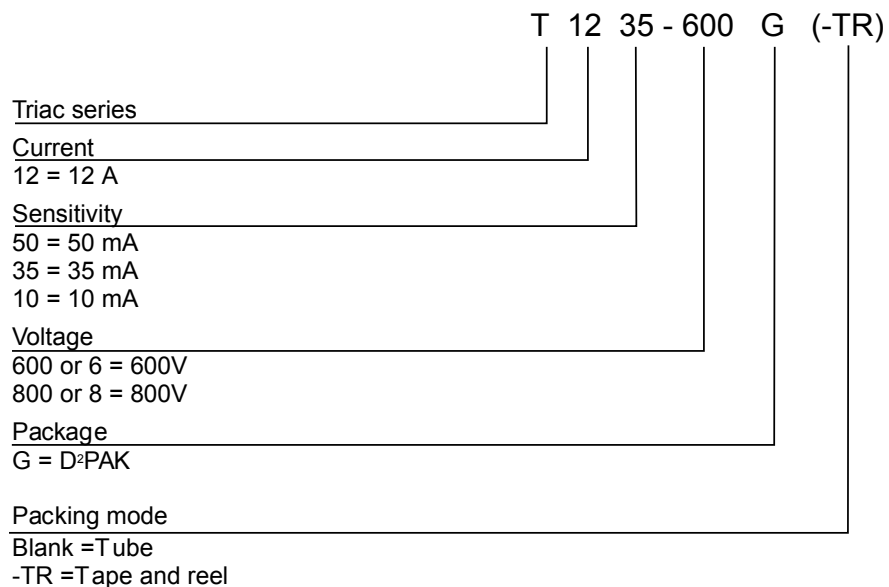

Table 8. Product selector

| Part number | Voltage (xxx) | | Sensitivity | Type | Package |
|-------------|---------------|-----|-------------|--------------|--------------------|
| | 600 | 800 | | | |
| BTB12-600C | X | | 25 mA | Standard | TO-220AB |
| BTB12-600B | X | | 50 mA | Standard | TO-220AB |
| BTB12-600TW | X | | 5 mA | Snubberless™ | TO-220AB |
| BTB12-600SW | X | | 10 mA | Snubberless™ | TO-220AB |
| BTB12-xxxCW | X | X | 35 mA | Snubberless™ | TO-220AB |
| BTB12-600BW | X | | 50 mA | Snubberless™ | TO-220AB |
| BTA12-600C | X | | 25 mA | Standard | TO-220AB Ins. |
| BTA12-xxxB | X | X | 50 mA | Standard | TO-220AB Ins. |
| BTA12-600TW | X | | 5 mA | Snubberless™ | TO-220AB Ins. |
| BTA12-xxxSW | X | X | 10 mA | Snubberless™ | TO-220AB Ins. |
| BTA12-xxxCW | X | X | 35 mA | Snubberless™ | TO-220AB Ins. |
| BTA12-xxxBW | X | X | 50 mA | Snubberless™ | TO-220AB Ins. |
| T1205-600G | X | | 5 mA | Snubberless™ | D ² PAK |
| T1210-6G | X | | 10 mA | Snubberless™ | D ² PAK |
| T1210-800G | | X | 10 mA | Snubberless™ | D ² PAK |
| T1235-xxxG | X | X | 35 mA | Snubberless™ | D ² PAK |
| T1250-600G | X | | 50 mA | Snubberless™ | D ² PAK |

Table 9. Ordering information

| Order code | Marking | Package | Weight | Base qty. | Delivery mode |
|---------------|-------------|--------------------|--------|-----------|-------------------|
| BTA12-600BRG | BTA12-600B | TO-220AB Ins. | 1.9 g | 50 | Tube |
| BTA12-600BWRG | BTA12-600BW | | | | |
| BTA12-600CRG | BTA12-600C | | | | |
| BTA12-600CWRG | BTA12-600CW | | | | |
| BTA12-600SWRG | BTA12-600SW | | | | |
| BTA12-600TWRG | BTA12-600TW | | | | |
| BTA12-800BRG | BTA12-800B | | | | |
| BTA12-800BWRG | BTA12-800BW | | | | |
| BTA12-800CWRG | BTA12-800CW | | | | |
| BTA12-800SWRG | BTA12-800SW | | | | |
| BTB12-600BRG | BTB12-600B | TO-220AB | | | |
| BTB12-600BWRG | BTB12-600BW | | | | |
| BTB12-600CRG | BTB12-600C | | | | |
| BTB12-600CWRG | BTB12-600CW | | | | |
| BTB12-600SWRG | BTB12-600SW | | | | |
| BTB12-600TWRG | BTB12-600TW | | | | |
| BTB12-800CWRG | BTB12-800CW | | | | |
| BTB12-800CWRG | BTB12-800CW | | | | |
| T1205-600G-TR | T1205-600G | D ² PAK | 1.38 g | 1000 | Tape and reel 13" |
| T1210-6G-TR | T1210-6G | | | | |
| T1210-800G-TR | T1210-800G | | | | |
| T1235-600G-TR | T1235-600G | | | | |
| T1235-800G-TR | T1235-800G | | | | |
| T1250-600G-TR | T1250-600G | | | | |
| T1210-6G | T1210-6G | | | 50 | Tube |
| T1235-600G | T1235-600G | | | | |

Table 10. Document revision history

| Date | Revision | Changes |
|-------------|----------|---|
| Sep-2002 | 6A | Last update. |
| 15-Mar-2005 | 7 | 1. I2PAK package added. 2. TO-220AB delivery mode changed from bulk to tube. |
| 27-May-2005 | 8 | T1210 added. |
| 28-Sep-2007 | 9 | Reformatted to current standards. T1250 added. |
| 02-Feb-2017 | 10 | Removed I ² PAK package. Updated Figure 7: "Non-repetitive surge peak on-state current" and Table 9: "Product selector" and Table 10: "Ordering information". |
| 9-Aug-2018 | 11 | Updated D ² PAK package information and Figure 10 . Updated Section Product status / summary . |
| 07-Feb-2019 | 12 | Updated links syntax. |

IMPORTANT NOTICE – PLEASE READ CAREFULLY

STMicroelectronics NV and its subsidiaries (“ST”) reserve the right to make changes, corrections, enhancements, modifications, and improvements to ST products and/or to this document at any time without notice. Purchasers should obtain the latest relevant information on ST products before placing orders. ST products are sold pursuant to ST’s terms and conditions of sale in place at the time of order acknowledgement.

Purchasers are solely responsible for the choice, selection, and use of ST products and ST assumes no liability for application assistance or the design of Purchasers’ products.

No license, express or implied, to any intellectual property right is granted by ST herein.

Resale of ST products with provisions different from the information set forth herein shall void any warranty granted by ST for such product.



ST and the ST logo are trademarks of ST. All other product or service names are the property of their respective owners.

Information in this document supersedes and replaces information previously supplied in any prior versions of this document.

© 2019 STMicroelectronics – All rights reserved

Looking for pricing, stock, or lifecycle information?

Click below to explore more details on WIN SOURCE:

-  [View BTB12-600SWRG on WIN SOURCE](#)
-  [STMicroelectronics](#) Information

Optimize Your Supply Chain with WIN SOURCE Solutions

-  Global Sourcing Solution
-  Obsolete Management
-  Cost Control Management
-  Shortage Management
-  Alternative Solution
-  Excess Inventory Management