



**THE DATASHEET OF  
BTB08-600TW**



### Snubberless™, logic level and standard 8 A Triacs



#### Features

- On-state rms current,  $I_{T(RMS)}$  8 A
- Repetitive peak off-state voltage,  $V_{DRM} / V_{RRM}$  600 V to 800 V
- Triggering gate current,  $I_{GT}$  5 to 50 mA

#### Description

Available either in through-hole and surface-mount packages, these devices are suitable for general purpose AC switching. They can be used as an ON/OFF function in applications such as static relays, heating regulation, induction motor starting circuits or for phase control operation in light dimmers and motor speed controllers, etc.

The Snubberless versions (BTA, BTB08\_XXXXW and T8 series) are specially recommended for use on inductive loads, thanks to their high commutation performance.

Logic level versions are designed to interface directly with low power drivers such as Microcontrollers.

By using an internal ceramic pad, the BTA series provide voltage insulated tab (rated at 2500  $V_{RMS}$ ) in compliance with UL standards (file ref.: E81734).

#### Product status link

[BTA08](#)

[BTB08](#)

[T810](#)

[T835](#)

[T850](#)

# 1 Characteristics

**Table 1. Absolute maximum ratings ( $T_j = 25\text{ °C}$  unless otherwise stated)**

Symbol	Parameter			Value	Unit
$I_{T(RMS)}$	RMS on-state current (full sine wave)	IPAK, DPAK, TO-220AB, D <sup>2</sup> PAK	$T_c = 110\text{ °C}$	8	A
		TO-220AB Ins.	$T_c = 100\text{ °C}$		
$I_{TSM}$	Non repetitive surge peak on-state current (full cycle, $T_j$ initial = $25\text{ °C}$ )	$f = 50\text{ Hz}$	$t = 20\text{ ms}$	80	A
		$f = 60\text{ Hz}$	$t_p = 16.7\text{ ms}$	84	
$I^2t$	$I^2t$ value for fusing		$t_p = 10\text{ ms}$	36	A <sup>2</sup> s
$di/dt$	Critical rate of rise of on-state current $I_G = 2 \times I_{GT}$ , $t_r \leq 100\text{ ns}$	$f = 120\text{ Hz}$	$T_j = 125\text{ °C}$	50	A/ $\mu$ s
$I_{GM}$	Peak gate current	$t_p = 20\text{ }\mu$ s	$T_j = 125\text{ °C}$	4	A
$P_{G(AV)}$	Average gate power dissipation		$T_j = 125\text{ °C}$	1	W
$T_{stg}$	Storage junction temperature range			-40 to +150	°C
$T_j$	Operating junction temperature range			-40 to +125	°C

**Table 2. Electrical characteristics ( $T_j = 25\text{ °C}$ , unless otherwise specified) Snubberless and logic level (3 quadrants)**

Symbol	Parameter	Quadrant	T8			BTA08/BTB08				Unit	
			10	35	50	TW	SW	CW	BW		
$I_{GT}^{(1)}$	$V_D = 12\text{ V}$ , $R_L = 30\text{ }\Omega$	I - II - III	Max.	10	35	50	5	10	35	50	mA
$V_{GT}$		I - II - III	Max.	1.2				V			
$V_{GD}$	$V_D = V_{DRM}$ , $R_L = 3.3\text{ k}\Omega$ , $T_j = 125\text{ °C}$	I - II - III	Min.	0.2				V			
$I_H^{(2)}$	$I_T = 100\text{ mA}$	I - II - III	Max.	15	35	75	10	15	35	50	mA
$I_L$	$I_G = 1.2 \times I_{GT}$	I - III	Max.	25	50	70	10	25	50	70	mA
		II	Max.	30	60	110	15	30	60	80	
$dV/dt^{(2)}$	$V_D = 67\% V_{DRM}$ , gate open, $T_j = 125\text{ °C}$		Max.	40	400	1000	20	40	400	1000	V/ $\mu$ s
$(di/dt)_c^{(2)}$	$(dV/dt)_c = 0.1\text{ V}/\mu$ s, $T_j = 125\text{ °C}$		Min.	5.4			3.5	5.4			A/ms
	$(dV/dt)_c = 10\text{ V}/\mu$ s, $T_j = 125\text{ °C}$		Min.	2.8			1.5	2.98			
	Without snubber, $T_j = 125\text{ °C}$		Min.		4.5	7			4.5	7	

1. Minimum  $I_{GT}$  is guaranteed at 5 % of  $I_{GT}$  max.

2. For both polarities of A2 referenced to A1

**Table 3. Standard (4 quadrants)**

Symbol	Parameter	Quadrant		BTA08/BTB08		Unit
				C	B	
$I_{GT}^{(1)}$	$V_D = 12\text{ V}, R_L = 33\ \Omega$	I - II - III	Max.	25	50	mA
		IV		50	100	
$V_{GT}$		All	Max.	1.3		V
$V_{GD}$	$V_D = V_{DRM}, R_L = 33\text{ k}\Omega, T_j = 125\text{ }^\circ\text{C}$	All	Min.	0.2		V
$I_H^{(2)}$	$I_T = 500\text{ mA}$	I - II - III	Max.	25	50	mA
$I_L$	$I_G = 1.2\ I_{GT}$	I - III - IV	Max.	40	50	mA
		II		80	100	
$dV/dt^{(2)}$	$V_D = 67\% V_{DRM}$ gate open, $T_j = 125\text{ }^\circ\text{C}$		Min.	200	400	V/ $\mu\text{s}$
$(dV/dt)_C^{(2)}$	$(dI/dt)_C = 3.5\text{ A/ms}, T_j = 125\text{ }^\circ\text{C}$		Min.	5	10	V/ $\mu\text{s}$

1. Minimum  $I_{GT}$  is guaranteed at 5 % of  $I_{GT}$  max.
2. For both polarities of A2 referenced to A1

**Table 4. Static electrical characteristics**

Symbol	Test conditions			Value	Unit
$V_{TM}^{(1)}$	$I_{TM} = 11\text{ A}, t_p = 380\ \mu\text{s}$	$T_j = 25\text{ }^\circ\text{C}$	Max.	1.55	V
$V_{TO}^{(1)}$	threshold on-state voltage	$T_j = 125\text{ }^\circ\text{C}$	Max.	0.85	V
$R_D^{(1)}$	Dynamic resistance	$T_j = 125\text{ }^\circ\text{C}$	Max.	50	m $\Omega$
$I_{DRM}\ I_{RRM}$	$V_{DRM} = V_{RRM}$	$T_j = 25\text{ }^\circ\text{C}$	Max.	5	$\mu\text{A}$
		$T_j = 125\text{ }^\circ\text{C}$	Max.	1	mA

1. For both polarities of A2 referenced to A1

**Table 5. Thermal resistance**

Symbol	Parameter		Value	Unit	
$R_{th(j-c)}$	Max. junction to case thermal resistance (AC)		IPAK / D2PAK / DPAK / TO-220AB	1.6	$^\circ\text{C/W}$
			TO-220AB Insulated	2.5	
$R_{th(j-a)}$	Junction to ambient (typ.)	$S = 2\text{ cm}^2^{(1)}$	D <sup>2</sup> PAK	45	$^\circ\text{C/W}$
		$S = 1\text{ cm}^2^{(1)}$	DPAK	70	
	Junction to ambient (typ.)	TO-220AB / TO-220AB Insulated		60	
		IPAK		100	

1.  $S$  = Copper surface under tab.

### 1.1 Characteristics (curves)

**Figure 1. Maximum power dissipation versus on-state RMS current (full cycle)**

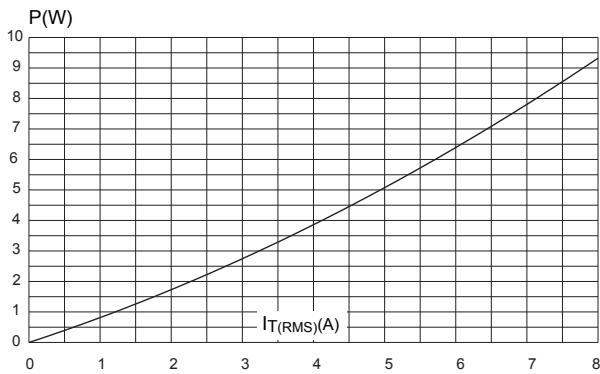

**Figure 2. RMS on-state current versus temperature (full cycle)**

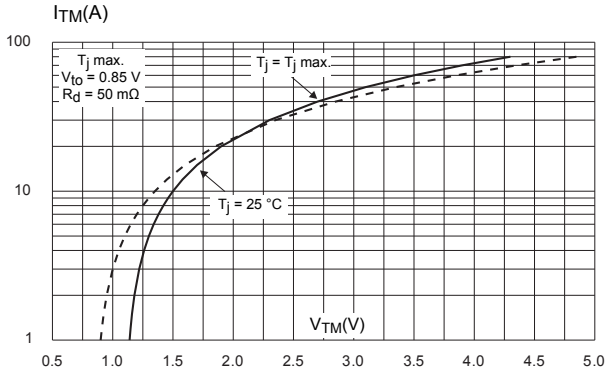
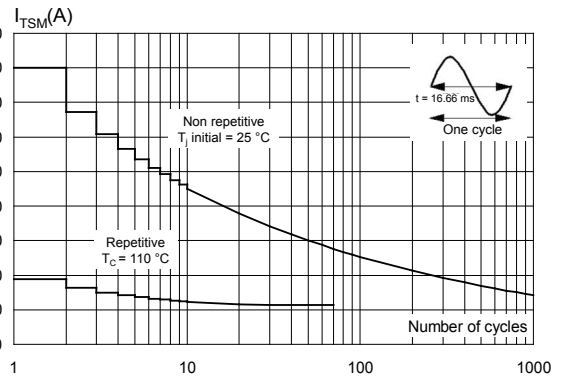
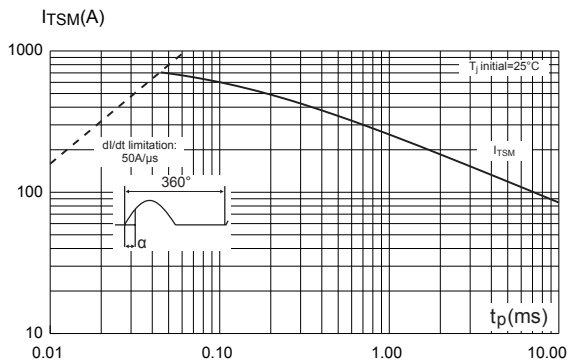
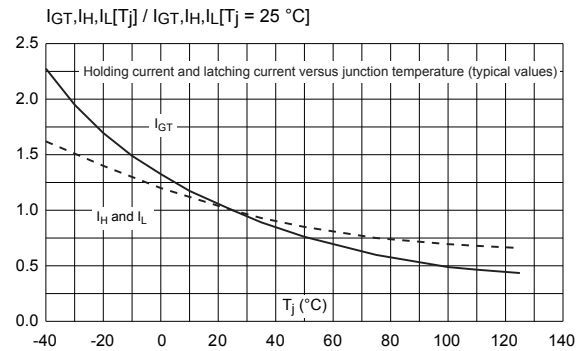
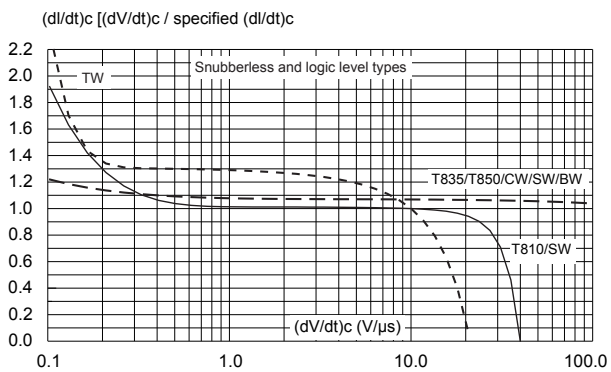
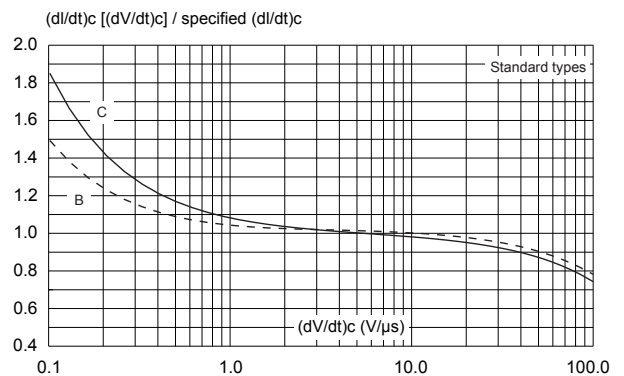

**Figure 3. RMS on-state current versus ambient temperature (full cycle)**



**Figure 4. Relative variation of thermal impedance versus pulse duration**

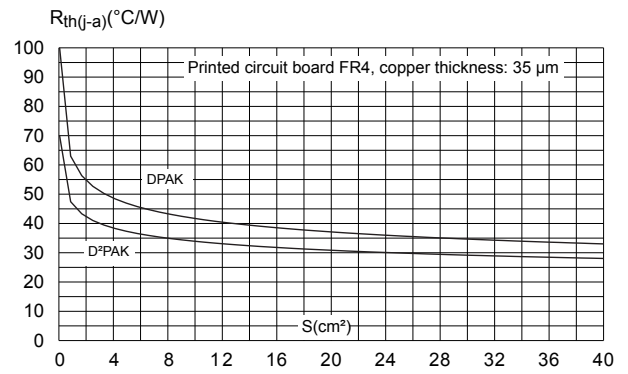

**Figure 5. On-state characteristics (maximum values)**

**Figure 6. Surge peak on-state current versus number of cycles**

**Figure 7. Non repetitive surge peak on-state current for a sinusoidal pulse ( $t_p < 10$  ms)**

**Figure 8. Relative variation of gate trigger current**

**Figure 9. Relative variation of critical rate of decrease of main current versus  $(dV/dt)_c$  (typical values)**

**Figure 10. Relative variation of critical rate of decrease of main current versus  $(dV/dt)_c$  (typical values)**

**Figure 11. Relative variation of critical rate of decrease of main current versus junction temperature**



**Figure 12. DPAK and D2PAK thermal resistance junction to ambient versus copper surface under tab**



## **2** Package information

---

In order to meet environmental requirements, ST offers these devices in different grades of ECOPACK® packages, depending on their level of environmental compliance. ECOPACK® specifications, grade definitions and product status are available at: [www.st.com](http://www.st.com). ECOPACK® is an ST trademark.

## 2.1 DPAK package information

- Epoxy meets UL94, V0
- Lead-free package
- Recommended torque: 0.4 to 0.6 N·m

Figure 13. DPAK package outline

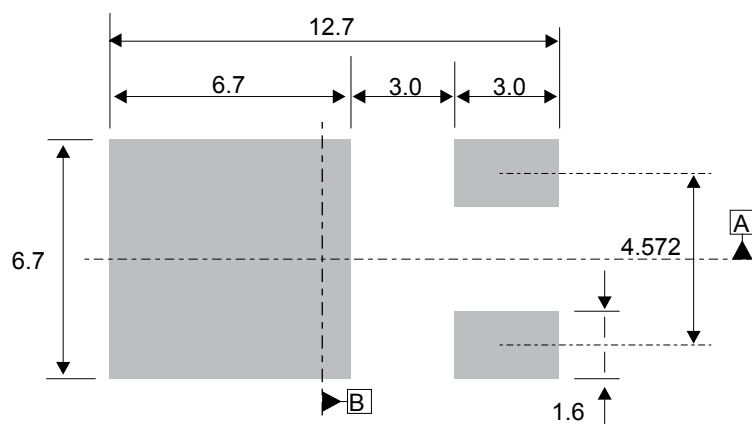

**Table 6. DPAK package mechanical data**

Ref.	Dimensions					
	Millimeters			Inches <sup>(1)</sup>		
	Min.	Typ.	Max.	Min.	Typ.	Max.
A	2.18		2.40	0.0858		0.0945
A1	0.90		1.10	0.0354		0.0433
A2	0.03		0.23	0.0012		0.0091
b	0.64		0.90	0.0252		0.354
b4	4.95		5.46	0.1949		0.2150
c	0.46		0.61	0.0181		0.0240
c2	0.46		0.60	0.0181		0.0236
D	5.97		6.22	0.2350		0.2449
D1	5.10			0.2008		
E	6.35		6.73	0.2500		0.2650
E1	4.32			0.1701		
e		2.29			0.0900	
e1		4.57			0.1800	
H	9.35		10.40	0.3681		0.4094
L	1.00		1.78	0.0394		0.0701
L2			1.27			0.0500
L4	0.60		1.02	0.0236		0.0402
V2	0°		+8°	0°		+8°

1. Dimensions in inches are given for reference only

Note: This package drawing may slightly differ from the physical package. However, all the specified dimensions are guaranteed.

**Figure 14. DPAK recommended footprint (dimensions are in mm)**

The device must be positioned within  $\oplus 0.05 \text{ AB}$

## 2.2 IPAK package information

Figure 15. IPAK package outline

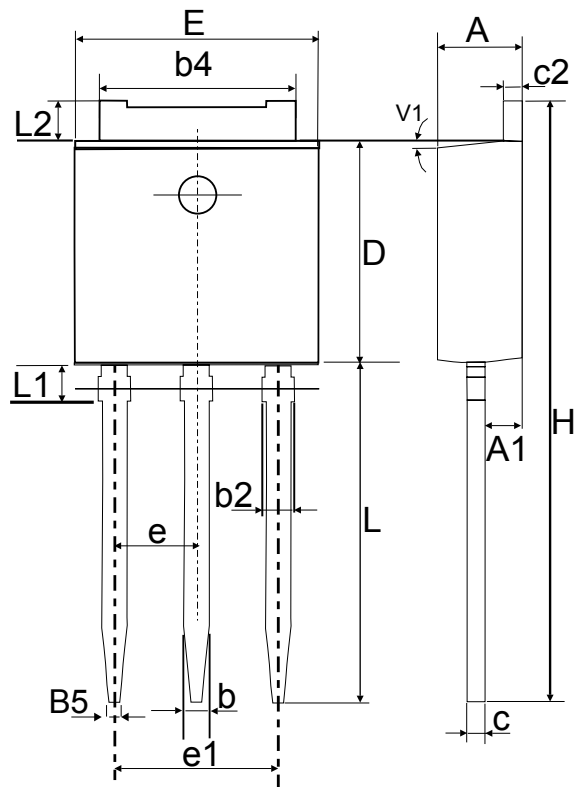

*Note:* This package drawing may slightly differ from the physical package. However, all the specified dimensions are guaranteed.

**Table 7. IPAK package mechanical data**

Ref.	Dimensions					
	Millimeters			Inches <sup>(1)</sup>		
	Min.	Typ.	Max.	Min.	Typ.	Max.
A	2.20		2.40	0.0866		0.0945
A1	0.90		1.10	0.0354		0.0433
b	0.64		0.90	0.0252		0.0354
b2			0.95			0.0374
b4	5.20		5.43	0.2047		0.2138
B5		0.30			0.0118	
c	0.45		0.60	0.0177		0.0236
c2	0.46		0.60	0.0181		0.0236
D	6.00		6.20	0.2362		0.2441
E	6.40		6.65	0.2520		0.2618
e		2.28			0.0898	
e1	4.40		4.60	0.1732		0.1811
H		16.10			0.6339	
L	9.00		9.60	0.3545		0.3780
L1	0.80		1.20	0.0315		0.0472
L2		0.80	1.25		0.0315	0.0492
V1		10°			10°	

1. Inch dimensions are for reference only.

### 2.3 TO-220AB insulated package information

Figure 16. TO-220AB insulated package outline



(1) Resin gate position accepted in one of the two positions or in the symmetrical opposites.

**Table 8. TO-220AB insulated package mechanical data**

Ref.	Dimensions					
	Millimeters			Inches		
	Min.	Typ.	Max.	Min.	Typ.	Max.
A	15.20		15.90	0.5984		0.6260
a1		3.75			0.1476	
a2	13.00		14.00	0.5118		0.5512
B	10.00		10.40	0.3937		0.4094
b1	0.61		0.88	0.0240		0.0346
b2	1.23		1.32	0.0484		0.0520
C	4.40		4.60	0.1732		0.1811
c1	0.49		0.70	0.0193		0.0276
c2	2.40		2.72	0.0945		0.1071
e	2.40		2.70	0.0945		0.1063
F	6.20		6.60	0.2441		0.2598
I	3.73		3.88	0.1469		0.1528
L	2.65		2.95	0.1043		0.1161
I2	1.14		1.70	0.0449		0.0669
I3	1.14		1.70	0.0449		0.0669
I4	15.80	16.40	16.80	0.6220	0.6457	0.6614
M		2.6			0.1024	

1. Inch dimensions are for reference only.

## 2.4 D<sup>2</sup>PAK package information

Figure 17. D<sup>2</sup>PAK package outline



(1) Resin gate position accepted in one of the two positions or in the symmetrical opposites

**Table 9. D<sup>2</sup>PAK package mechanical data**

Ref.	Dimensions					
	Millimeters			Inches		
	Min.	Typ.	Max.	Min.	Typ.	Max.
A	4.30		4.60	0.1693		0.1811
A1	2.49		2.69	0.0980		0.1059
A2	0.03		0.23	0.0012		0.0091
A3		0.25			0.0098	
b	0.70		0.93	0.0276		0.0366
b2	1.25		1.7	0.0492		0.0669
c	0.45		0.60	0.0177		0.0236
c2	1.21		1.36	0.0476		0.0535
D	8.95		9.35	0.3524		0.3681
D1	7.50		8.00	0.2953		0.3150
D2	1.30		1.70	0.0512		0.0669
e	2.54			0.1		
E	10.00		10.28	0.3937		0.4047
E1	8.30		8.70	0.3268		0.3425
E2	6.85		7.25	0.2697		0.2854
G	4.88		5.28	0.1921		0.2079
H	15		15.85	0.5906		0.6240
L	1.78		2.28	0.0701		0.0898
L2	1.27		1.40	0.0500		0.0551
L3	1.40		1.75	0.0551		0.0689
R		0.40			0.0157	
V2	0°		8°	0°		8°

1. Dimensions in inches are given for reference only

Figure 18. D<sup>2</sup>PAK recommended footprint (dimensions are in mm)



### 3 Ordering information

**Figure 19. Ordering information scheme (BTA08 and BTB08 series)**

**Figure 20. Ordering information scheme (T8 series)**

**Table 10. Product selector**

Part Number	Voltage (xxx)		Sensitivity	Type	Package
	600	800			
T810-xxxB	X	X	10 mA	Logic Level	DPAK
T835-xxxH	X		35 mA	Snubberless™	IPAK
T810-xxxG	X		10 mA	Logic Level	D <sup>2</sup> PAK
T835-xxxG	X	X	35 mA	Snubberless™	D <sup>2</sup> PAK
T850-xxxG	X	X	50 mA	Snubberless™	D <sup>2</sup> PAK
BTA08-xxxS	X		10 mA	Logic Level	TO-220AB Ins.
BTA08-xxxC	X	X	35 mA	Standard	TO-220AB Ins.
BTA08-xxxB	X		50 mA	Standard	TO-220AB Ins.
BTA08-xxxTW	X		5 mA	Logic Level	TO-220AB Ins.
BTA08-xxxSW	X		10 mA	Logic Level	TO-220AB Ins.
BTA08-xxxCW	X		35 mA	Snubberless™	TO-220AB Ins.
BTA08-xxxBW	X	X	50 mA	Snubberless™	TO-220AB Ins.
BTB08-xxxS	X		10 mA	Logic Level	TO-220AB
BTB08-xxxC	X		35 mA	Standard	TO-220AB
BTB08-xxxB	X		50 mA	Standard	TO-220AB
BTB08-xxxTW	X	X	5 mA	Logic Level	TO-220AB
BTB08-xxxSW	X		10 mA	Logic Level	TO-220AB
BTB08-xxxCW	X	X	35 mA	Snubberless™	TO-220AB
BTB08-xxxBW	X		50 mA	Snubberless™	TO-220AB

**Table 11. Ordering information**

Order code	Marking	Package	Weight	Base qty.	Delivery mode		
T810-600B	T8 1060	DPAK	0.30	75	Tube		
T835-600B	T8 3560						
T835-800B	T8 3580						
T810-600B-TR	T8 1060			D <sup>2</sup> PAK	1.50	2500	Tape&Reel 13"
T810-800B-TR	T8 1080						
T835-600B-TR	T8 3560						
T835-800B-TR	T8 3580						
T835-600H	T8 3560	IPAK	0.40	75	Tube		
T835-600G	T835-600G	D <sup>2</sup> PAK	1.50	50	Tube		
T835-8G	T835-8G						
T850-6G	T850-6G						
T850-8G	T850-8G						
T810-600G-TR	T810-600G			1000	Tape&Reel 13"		
T835-600G-TR	T835-600G						
T835-8G-TR	T835-8G						
T850-6G-TR	T850-6G						
T850-8G-TR	T850-8G	TO-220AB	2.30	50	Tube		
BTA08-600SRG	BTA08-600S						
BTA08-600BRG	BTA08-600B						
BTA08-600CRG	BTA08-600C						
BTA08-800CRG	BTA08-800C						
BTA08-600BWRG	BTA08-600BW						
BTA08-600CWRG	BTA08-600CW						
BTA08-600SWRG	BTA08-600SW						
BTA08-600TWRG	BTA08-600TW						
BTA08-800BWRG	BTA08-800BW						
BTB08-600BRG	BTB08-600B						
BTB08-600CRG	BTB08-600C						
BTB08-600SRG	BTB08-600S						
BTB08-600BWRG	BTB08-600BW						
BTB08-600CWRG	BTB08-600CW						
BTB08-600SWRG	BTB08-600SW						
BTB08-600TWRG	BTB08-600TW						
BTB08-800CWRG	BTB08-800CW						
BTB08-800TWRG	BTB08-800TW						

**Table 12. Document revision history**

Date	Revision	Changes
Apr-2002	5A	Last update.
13-Feb-2006	6	TO-220AB delivery mode changed from bulk to tube. ECOPACK statement added.
10-Mar-2010	7	Updated ECOPACK statement and Figure 26
02-Jun-2014	8	Updated DPAK and IPAK package information and reformatted to current standard.
07-Nov-2016	9	Updated Table 1 and reformatted to current standard.
06-Jan-2017	10	Updated Figure 20: "Ordering information scheme (T8 series)", Table 10: "Product selector" and Table 11: "Ordering information".
09-Feb-2017	11	Added T850 package information.
24-Apr-2017	12	Updated Figure 6.. Minor text changes to improve readability.
14-Mar-2018	13	Updated Table 2. Electrical characteristics ( $T_j = 25\text{ }^\circ\text{C}$ , unless otherwise specified) Snubberless and logic level (3 quadrants), cover image, Figure 9. Relative variation of critical rate of decrease of main current versus $(dV/dt)_c$ (typical values) and Figure 20. Ordering information scheme (T8 series).
14-May-2018	14	Updated product status links.
09-Aug-2018	15	Updated Table 3. Standard (4 quadrants).

**IMPORTANT NOTICE – PLEASE READ CAREFULLY**

STMicroelectronics NV and its subsidiaries (“ST”) reserve the right to make changes, corrections, enhancements, modifications, and improvements to ST products and/or to this document at any time without notice. Purchasers should obtain the latest relevant information on ST products before placing orders. ST products are sold pursuant to ST’s terms and conditions of sale in place at the time of order acknowledgement.

Purchasers are solely responsible for the choice, selection, and use of ST products and ST assumes no liability for application assistance or the design of Purchasers’ products.

No license, express or implied, to any intellectual property right is granted by ST herein.

Resale of ST products with provisions different from the information set forth herein shall void any warranty granted by ST for such product.



ST and the ST logo are trademarks of ST. All other product or service names are the property of their respective owners.

Information in this document supersedes and replaces information previously supplied in any prior versions of this document.

© 2018 STMicroelectronics – All rights reserved

## Looking for pricing, stock, or lifecycle information?

Click below to explore more details on WIN SOURCE:

-  [View BTB08-600TW on WIN SOURCE](#)
-  [STMicroelectronics](#) Information

## Optimize Your Supply Chain with WIN SOURCE Solutions

-  Global Sourcing Solution
-  Obsolete Management
-  Cost Control Management
-  Shortage Management
-  Alternative Solution
-  Excess Inventory Management